

Specification

Part No.	:	SDCP.5900.12.4.A.40
Product Name	:	5.9GHz Circular Polarized Embedded DSRC SMD Patch Antenna
Features	:	5.9GHz Ceramic Patch Antenna DSRC 5850MHz to 5925MHz Peak Gain: 4.64dBi TS16949 Production & Quality Approved Efficiency: >60% Dims: 12*12*4mm RoHS compliant



1. Introduction

The SDCP.5900.12.4.A.40 is a 12*12*4mm embedded ceramic DSRC Patch antenna. It is a high performance directional antenna designed to operate at 5850 MHz to 5925 MHz for DSRC / V2V / V2X / V2I systems. The directionality of the antenna allows further range of DSRC communications. For example, one patch can be mounted to front of vehicle, and one to back.

Its tiny size allows placement in crowded vehicle interiors. The SMD mounting is particularly suited to high volume manufacturing applications.

Typical Applications:

- Automotive Rearview Mirror Back Mount
- In Vehicle Window Mount
- Embedded in Roadside Transceivers

DSRC (Dedicated Short Range Communications) is the communications media of choice for active safety V2V/V2X (Vehicle to Vehicle and Vehicle to Other) systems, primarily allocated for vehicle safety applications. DSRC supports high speed, low latency, short- range V2V/V2X wireless communications.

The SDCP.5900 patch antenna has been designed to be circularly polarized to enable a more stable system signal strength typically required on moving vehicles. Circular polarization limits any potential drop in signal from orientation change to 3dB compared to a potential drop of 40dB or more for linear solutions. It results in a system that will maintain the communication link much more reliably.

For further optimization to customer specific device environments and for support to integrate and test this antenna's performance in your device, contact your regional Taoglas office.

2. Specification

DSRC	
Frequency	5850~5925MHz
Efficiency	60.45 %
Peak Gain	4.64 dBi
Average Gain	-2.15 dBi
VSWR	< 2
Polarization	RHCP
Axial Ratio	< 4
Impedance	50 Ohms
MECHANICAL	
Dimensions	12*12*4mm
Weight	2.0g
ENVIRONMENTAL	
Temperature Range	-40°C to 125°C
Humidity	Non-condensing 65°C 95% RH

*Antenna properties were measured with the antenna mounted on 50*50 mm ground plane.

**Taoglas Part Number SDCPD.12A

3. Antenna Characteristics

3.1. VSWR

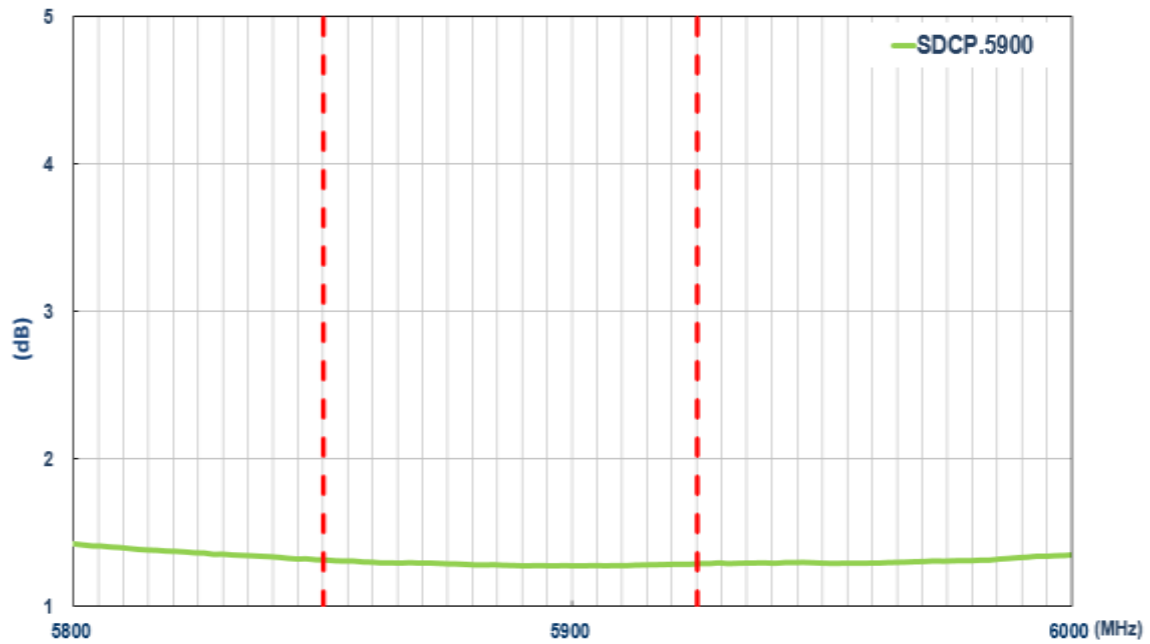

3.2. Efficiency

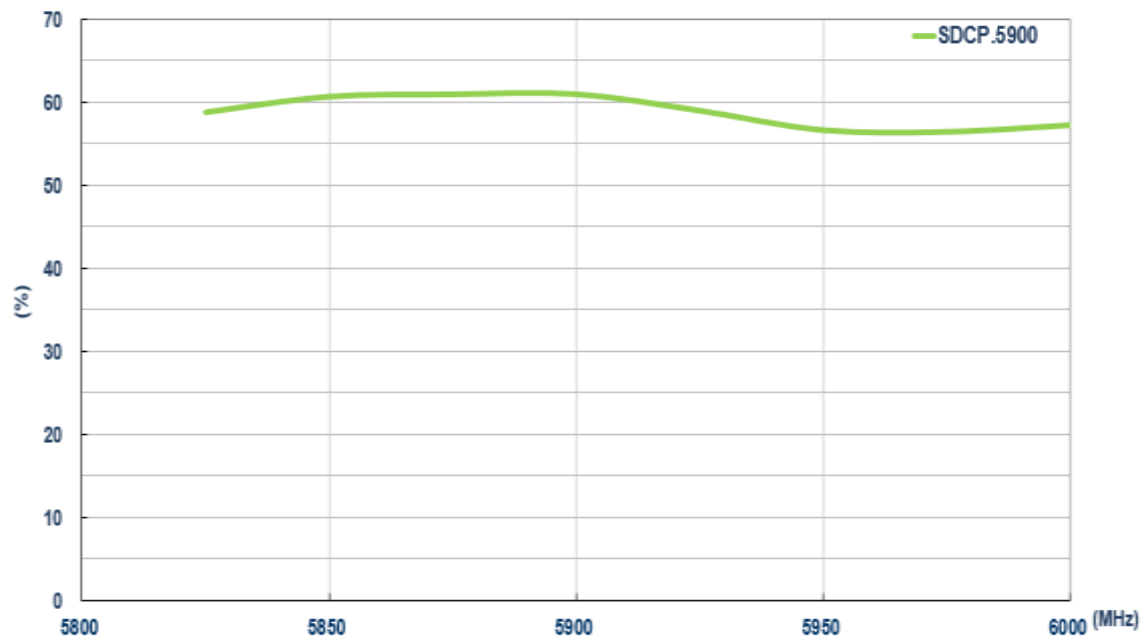

3.3. Peak Gain

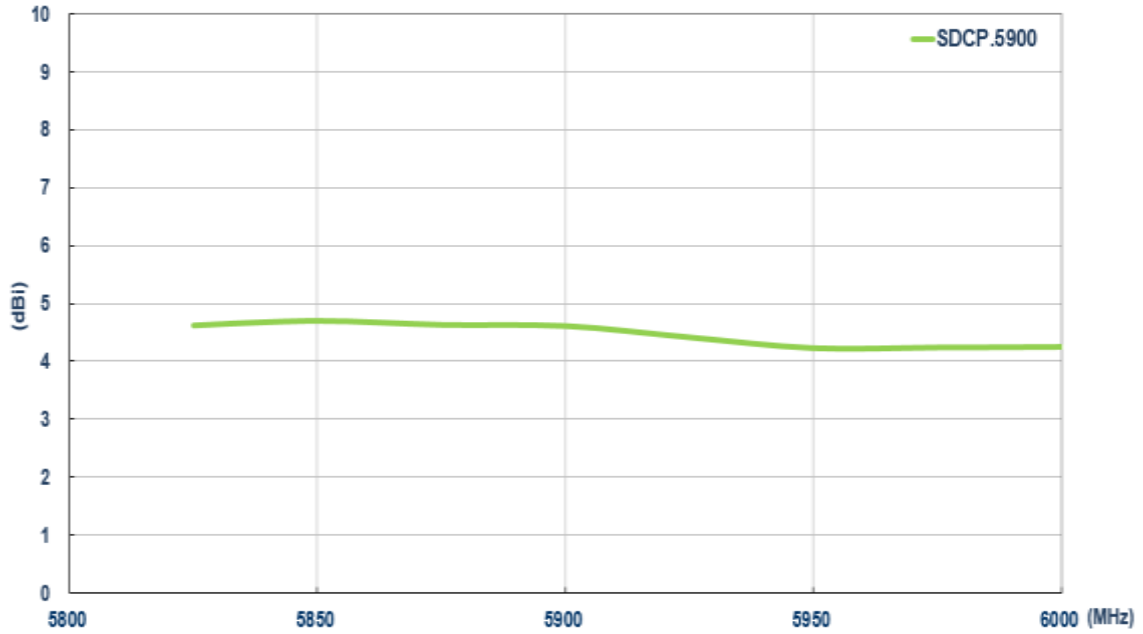

3.4. Average Gain

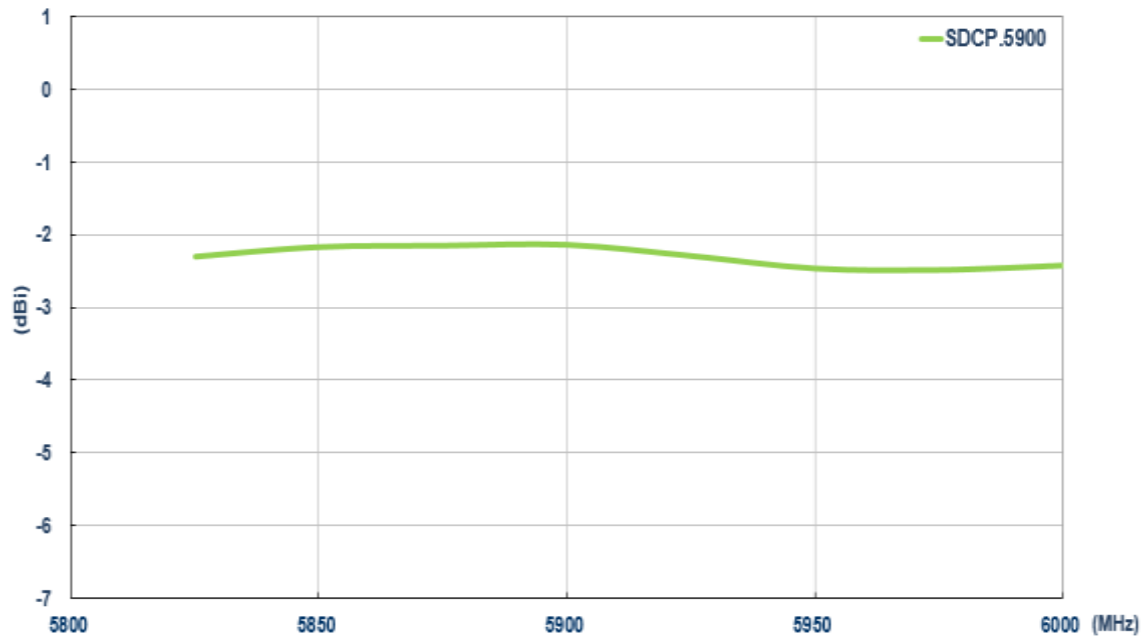

3.5. Axial Ratio

3.5.1. XZ Plane

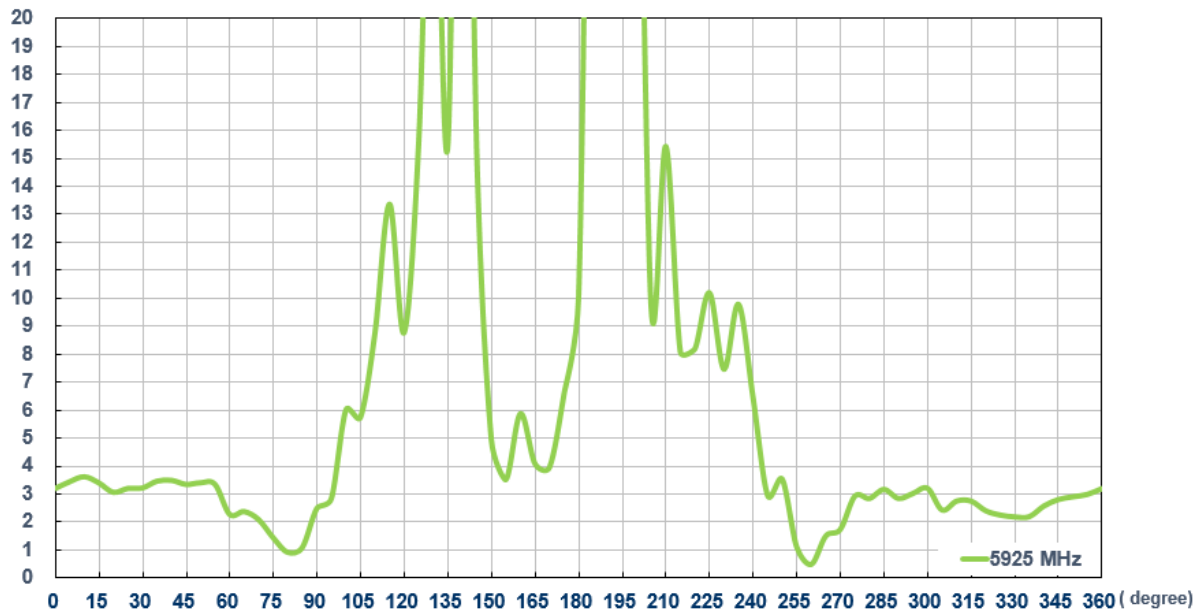
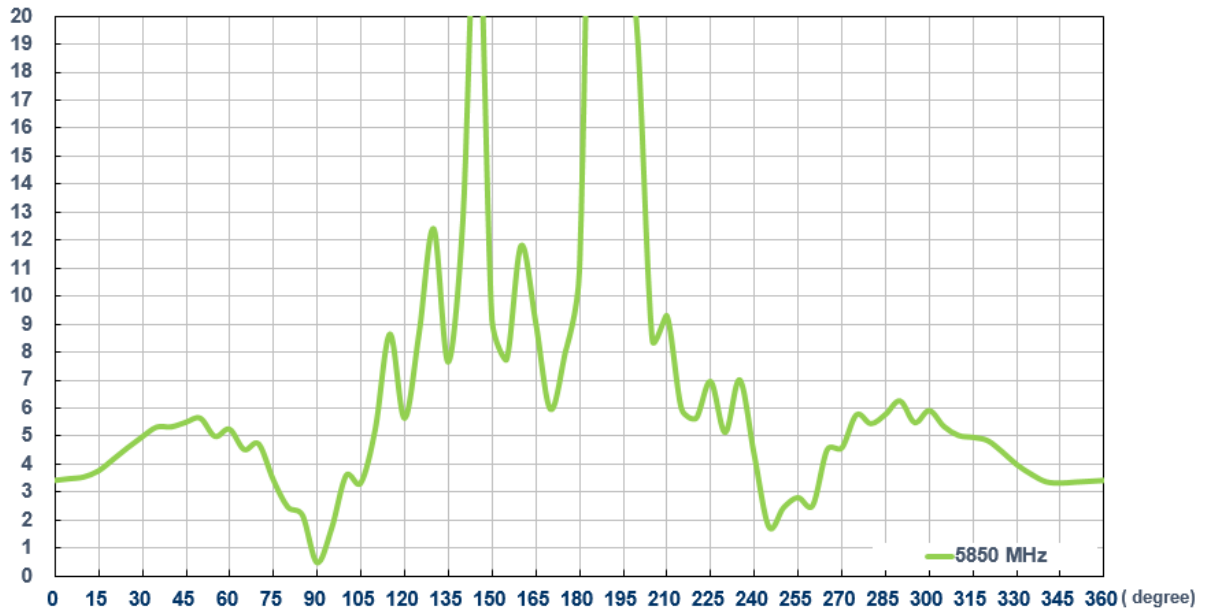

3.5.2. YZ Plane

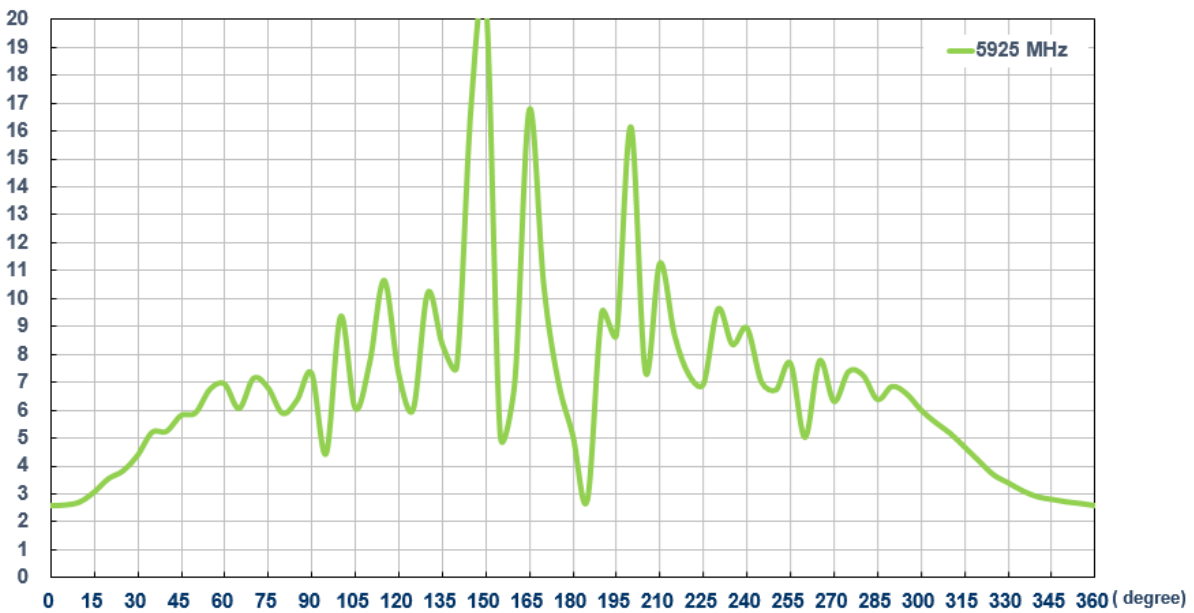
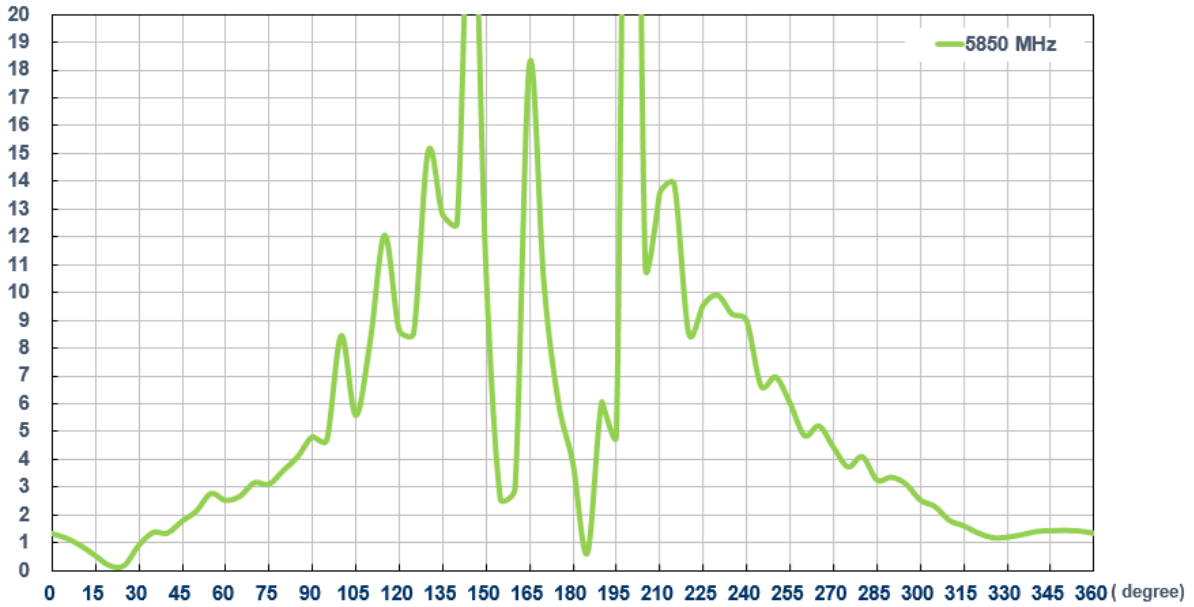

4. Antenna Radiation Patterns

4.1. Antenna Setup (Antenna testing Setup in ETS Anechoic Chamber)

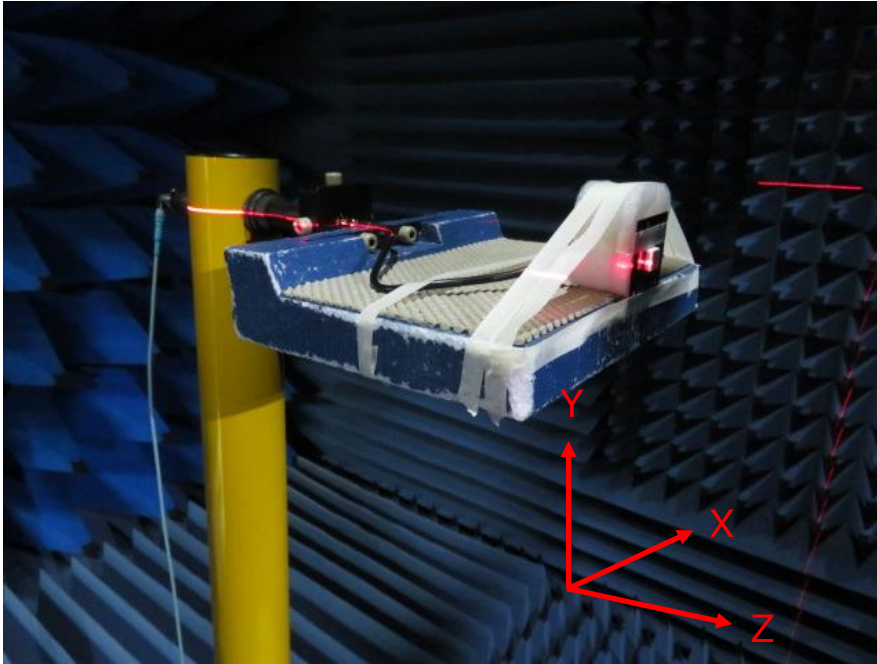

4.2. 2D Radiation Patterns

XY Plane

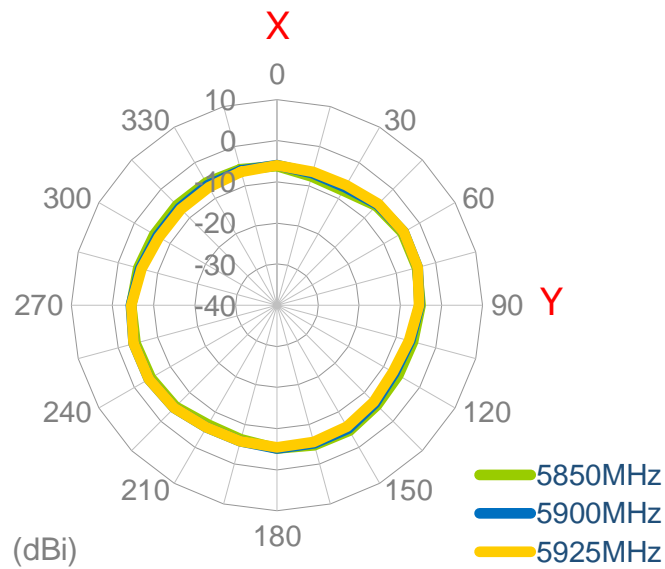

XZ Plane

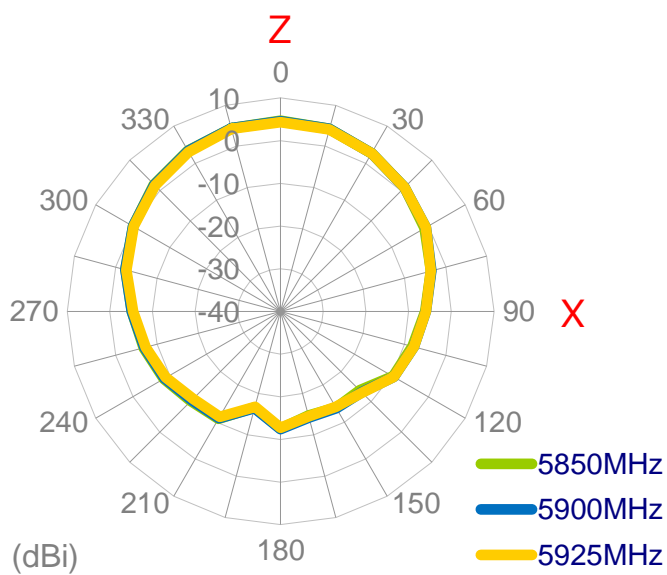

YZ Plane

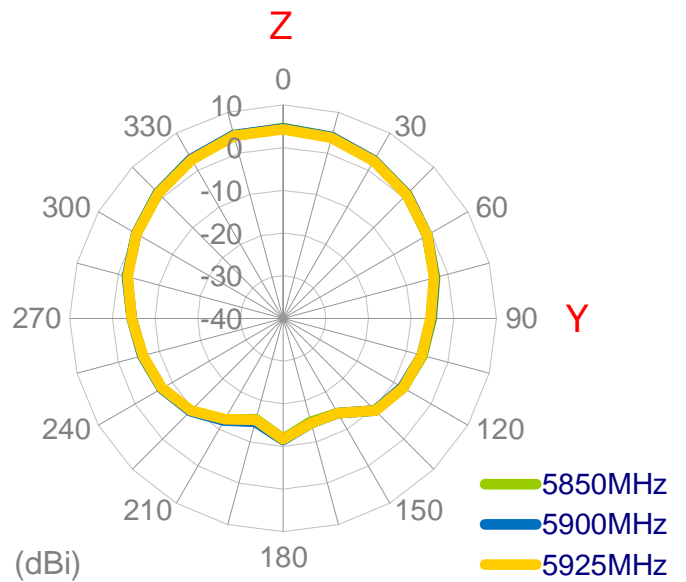

4.3. Antenna 3D Radiation Pattern (In free space)

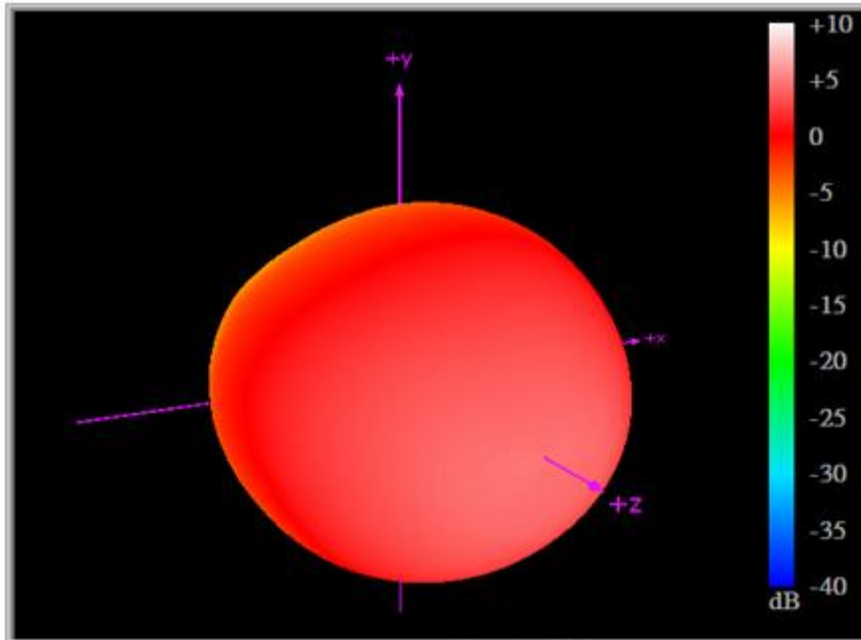

5850MHz

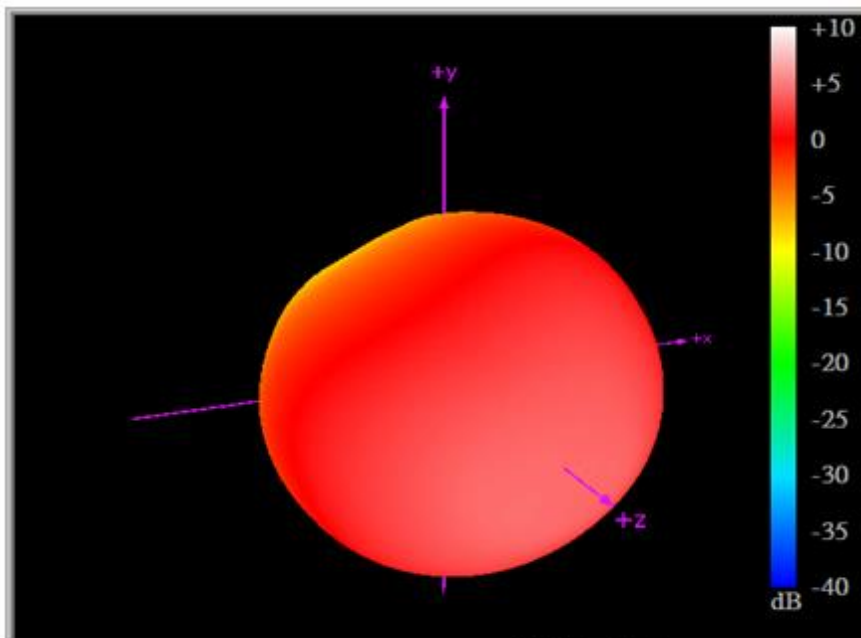

5925MHz

5. Mechanical Drawing (Unit: mm)

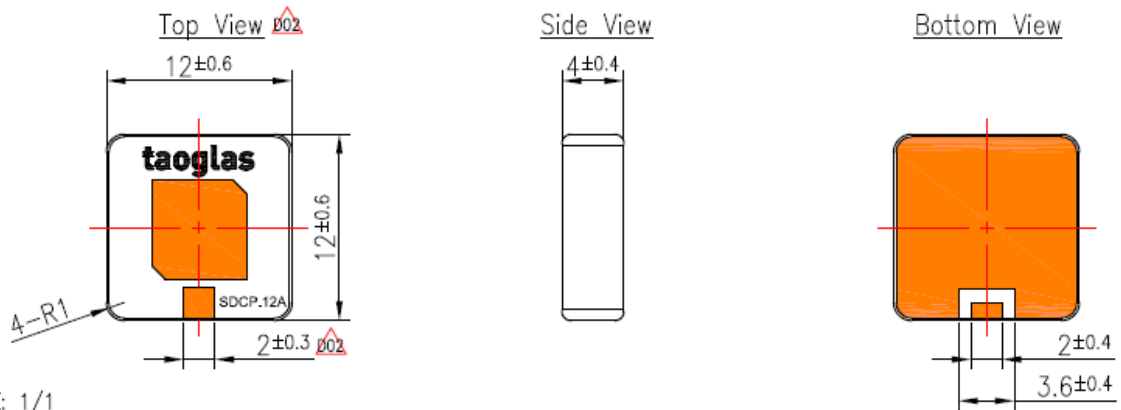

SCALE: 1/1

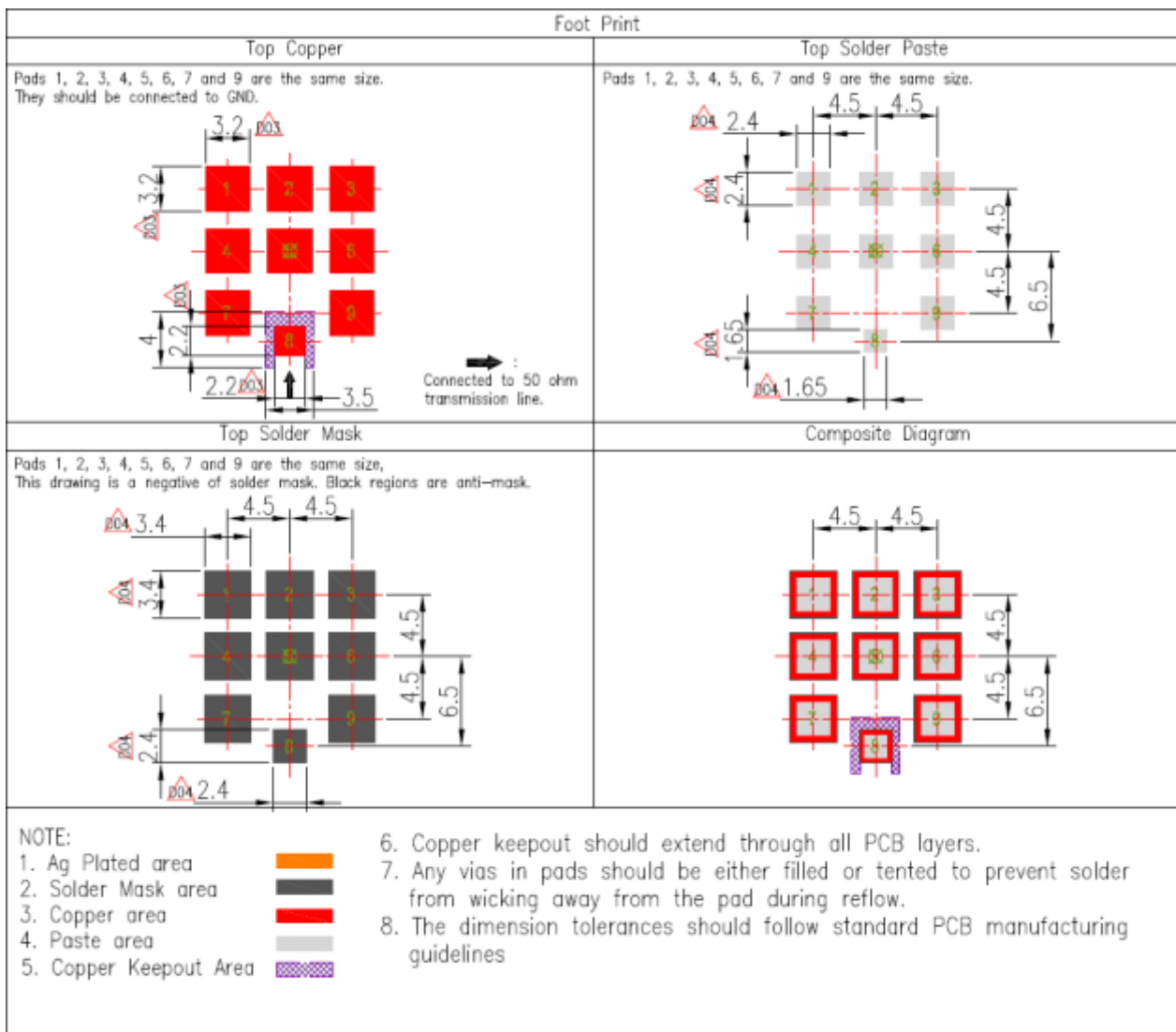

6. Evaluation Board (SDCPD.12.A)

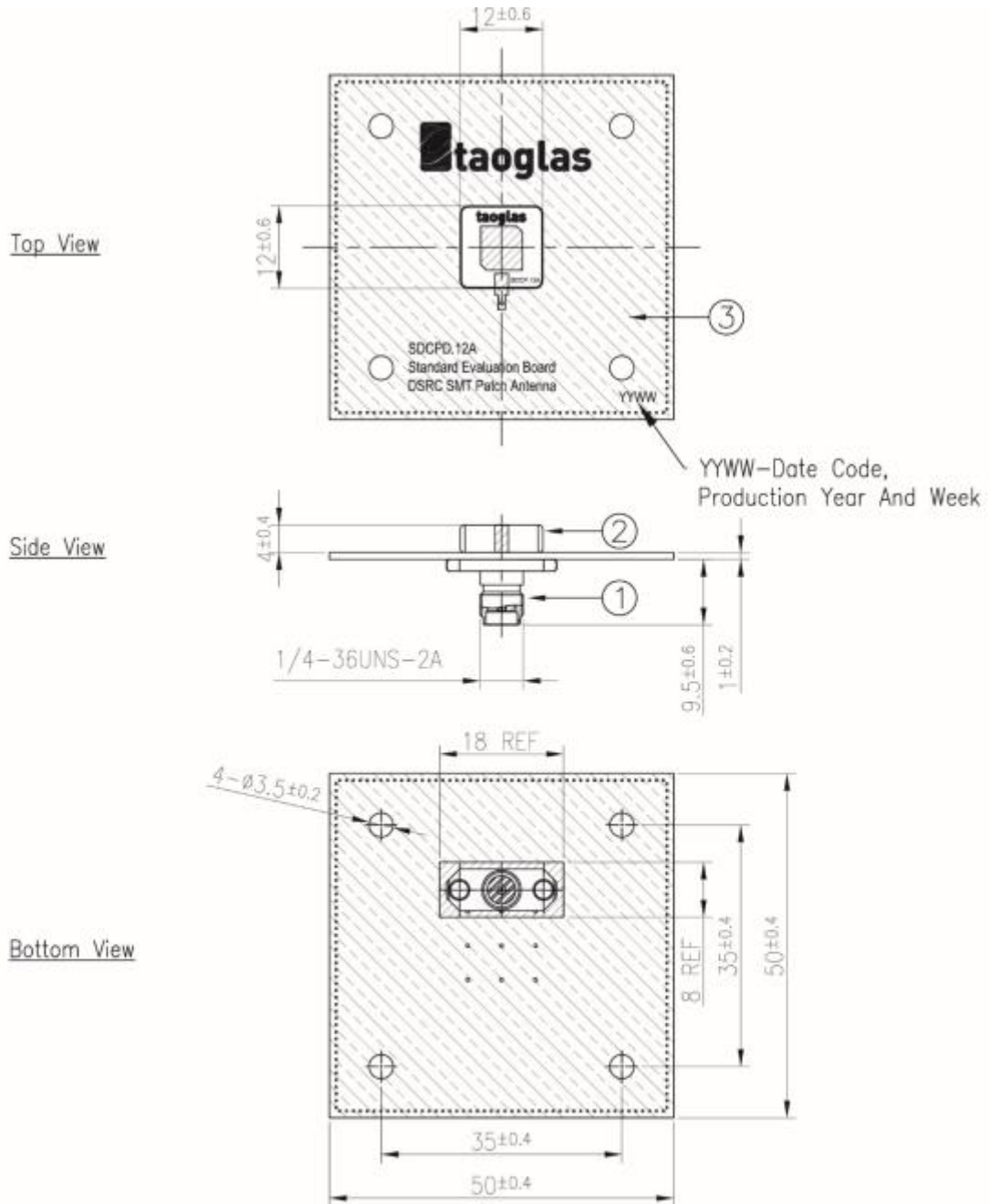

Note:

1. Silver Area 
2. Soldermask Area 
3. Logo & Text Ink Printing : White

	Name	Material	Finish	QTY
1	PCB SMA(F)ST	Brass	Au Plated	1
2	SDCP.12A Patch(12x12x4mm)	Ceramic	Clear	1
3	SDCPD.12A PCB	Composite 1.0t	Black	1

7. Recommended Reflow Soldering Profile

SDCP.5900.12A can be assembled following Pb-free assembly. According to the Standard IPC/JEDEC J-STD-020C, the temperature profile suggested is as follows:

Phase	Profile Features	Pb-Free Assembly (SnAgCu)
PREHEAT	Temperature Min(T_{smin}) Temperature Max(T_{smax}) Time(t_s) from (T_{smin} to T_{smax})	150°C 200°C 60-120 seconds
RAMP-UP	Avg. Ramp-up Rate (T_{smax} to T_P)	3°C/second(max)
REFLOW	Temperature(T_L) Total Time above T_L (t_L)	217°C 30-100 seconds
PEAK	Temperature(T_P) Time(t_p)	260°C 2-5 seconds
RAMP-DOWN	Rate	3°C/second(max)
Time from 25°C to Peak Temperature		8 minutes max.
Composition of solder paste		96.5Sn/3Ag/0.5Cu
Solder Paste Model		SHENMAO PF606-P26

The graphic shows temperature profile for component assembly process in reflow ovens

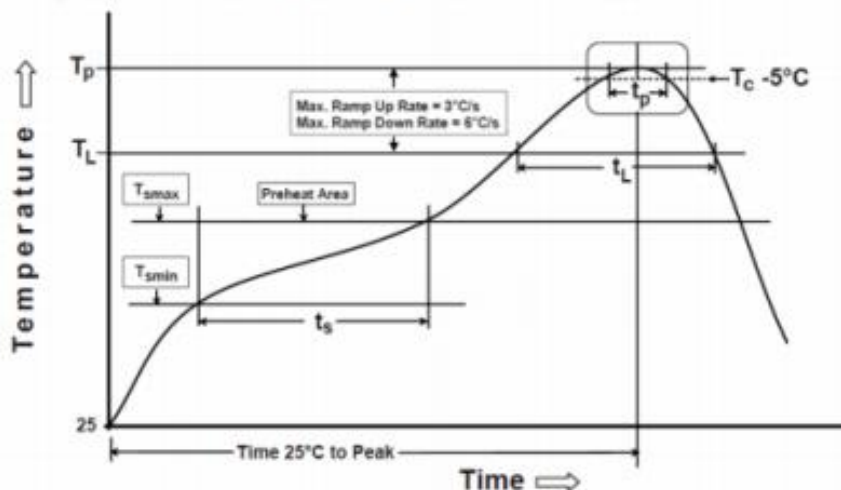

Soldering iron condition: Soldering iron temperature $270^{\circ}\text{C} \pm 10^{\circ}\text{C}$.

Apply preheating at 120°C for 2-3 minutes. Finish soldering for each terminal within 3 seconds, if soldering iron temperature over $270^{\circ}\text{C} \pm 10^{\circ}\text{C}$ or 3 seconds, it will make cause component surface peeling or damage.

8. Packaging

500 pc SDCP.5900.12.4.A.40 per reel
 Dimensions - Ø330*55mm
 Weight - 2300g

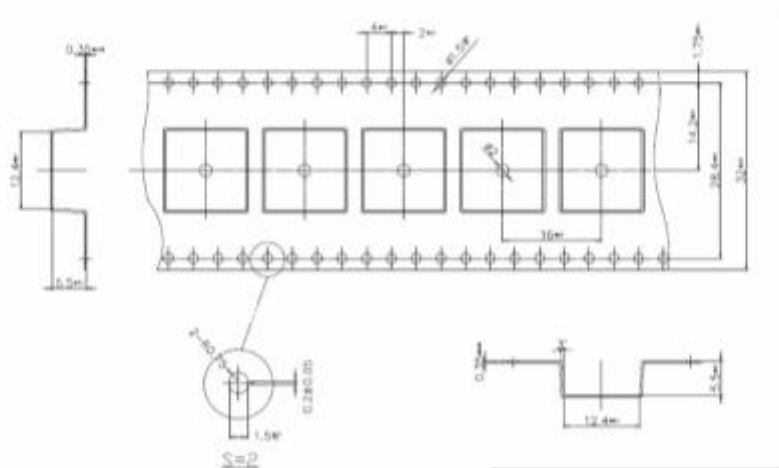
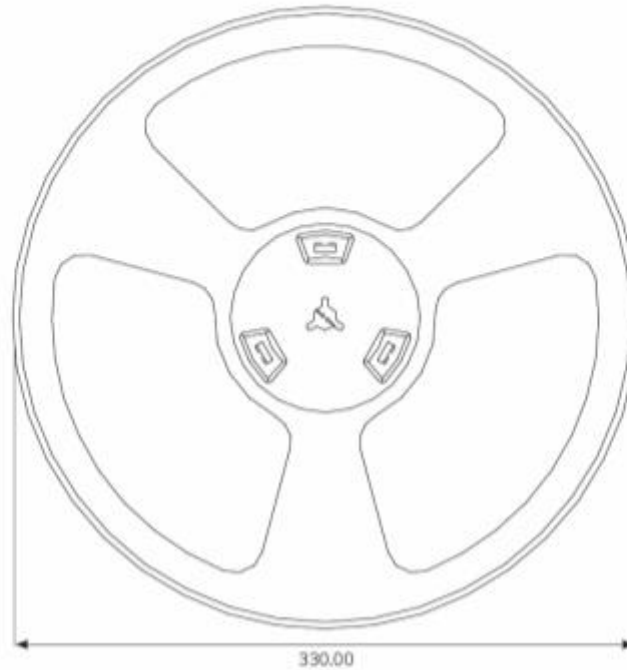

1 pc reel in small in Anti-static Bag
Dimensions - 340*350*70mm
Weight - 2400g

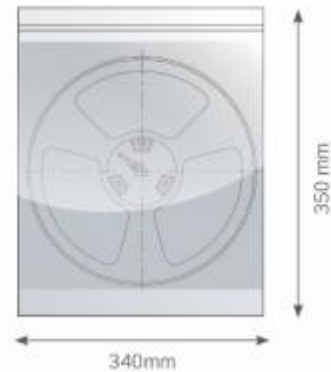

4 Reels in Anti-static Bags
2000 pcs in one carton
Carton Dimensions - 370*360*305mm
Weight - 10.5Kg

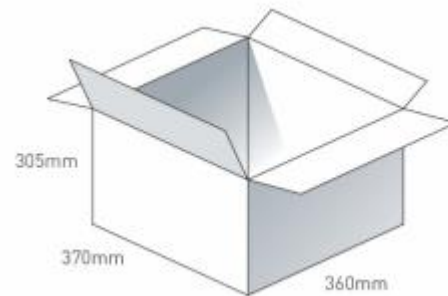

Pallet Dimensions 1200*1000*1420mm
24 Cartons per Pallet
6 Cartons per layer
4 Layers

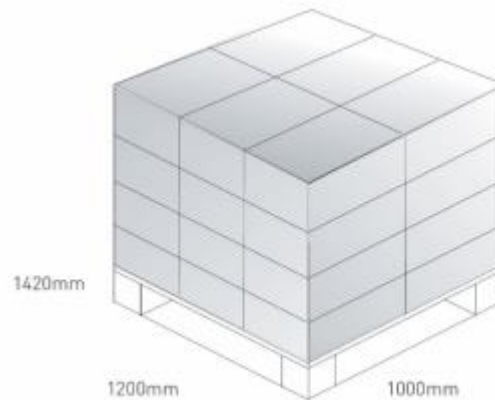

Taoglas makes no warranties based on the accuracy or completeness of the contents of this document and reserves the right to make changes to specifications and product descriptions at any time without notice. Taoglas reserves all rights to this document and the information contained herein.

Reproduction, use or disclosure to third parties without express permission is strictly prohibited.

Copyright © Taoglas Ltd.