



User Manual

ARK-3510

Fanless Embedded Box PC

ADVANTECH

Enabling an Intelligent Planet

Attention!

Please note:

This package contains a hard-copy user manual in Chinese for China CCC certification purposes, and there is an English user manual included as a PDF file on the CD. Please disregard the Chinese hard copy user manual if the product is not to be sold and/or installed in China.

Copyright

The documentation and the software included with this product are copyrighted 2010 by Advantech Co., Ltd. All rights are reserved. Advantech Co., Ltd. reserves the right to make improvements in the products described in this manual at any time without notice.

No part of this manual may be reproduced, copied, translated or transmitted in any form or by any means without the prior written permission of Advantech Co., Ltd. Information provided in this manual is intended to be accurate and reliable. However, Advantech Co., Ltd. assumes no responsibility for its use, nor for any infringements of the rights of third parties, which may result from its use.

Acknowledgements

Award is a trademark of Award Software International, Inc.

VIA is a trademark of VIA Technologies, Inc.

IBM, PC/AT, PS/2 and VGA are trademarks of International Business Machines Corporation.

Intel® and Pentium® are trademarks of Intel Corporation.

Microsoft Windows® is a registered trademark of Microsoft Corp.

RTL is a trademark of Realtek Semi-Conductor Co., Ltd.

ESS is a trademark of ESS Technology, Inc.

UMC is a trademark of United Microelectronics Corporation.

SMI is a trademark of Silicon Motion, Inc.

Creative is a trademark of Creative Technology LTD.

CHRONTEL is a trademark of Chrontel Inc.

All other product names or trademarks are properties of their respective owners.

For more information about this and other Advantech products, please visit our website at:

<http://www.advantech.com/>

<http://www.advantech.com/ePlatform/>

For technical support and service, please visit our support website at:

<http://support.advantech.com.tw/support/>

Product Warranty (2 years)

Advantech warrants to you, the original purchaser, that each of its products will be free from defects in materials and workmanship for two years from the date of purchase.

This warranty does not apply to any products which have been repaired or altered by persons other than repair personnel authorized by Advantech, or which have been subject to misuse, abuse, accident or improper installation. Advantech assumes no liability under the terms of this warranty as a consequence of such events.

Because of Advantech's high quality-control standards and rigorous testing, most of our customers never need to use our repair service. If an Advantech product is defective, it will be repaired or replaced at no charge during the warranty period. For out-of-warranty repairs, you will be billed according to the cost of replacement materials, service time and freight. Please consult your dealer for more details.

If you think you have a defective product, follow these steps:

1. Collect all the information about the problem encountered. (For example, CPU speed, Advantech products used, other hardware and software used, etc.) Note anything abnormal and list any onscreen messages you get when the problem occurs.
2. Call your dealer and describe the problem. Please have your manual, product, and any helpful information readily available.
3. If your product is diagnosed as defective, obtain an RMA (return merchandise authorization) number from your dealer. This allows us to process your return more quickly.
4. Carefully pack the defective product, a fully-completed Repair and Replacement Order Card and a photocopy proof of purchase date (such as your sales receipt) in a shippable container. A product returned without proof of the purchase date is not eligible for warranty service.
5. Write the RMA number visibly on the outside of the package and ship it prepaid to your dealer.

Declaration of Conformity

FCC Class A

Note: This equipment has been tested and found to comply with the limits for a Class A digital device, pursuant to part 15 of the FCC Rules. These limits are designed to provide reasonable protection against harmful interference when the equipment is operated in a commercial environment. This equipment generates, uses, and can radiate radio frequency energy and, if not installed and used in accordance with the instruction manual, may cause harmful interference to radio communications. Operation of this equipment in a residential area is likely to cause harmful interference in which case the user will be required to correct the interference at his own expense.

Technical Support and Assistance

1. Visit the Advantech web site at www.advantech.com/support where you can find the latest information about the product.
2. Contact your distributor, sales representative, or Advantech's customer service center for technical support if you need additional assistance. Please have the following information ready before you call:
 - Product name and serial number
 - Description of your peripheral attachments
 - Description of your software (operating system, version, application software, etc.)
 - A complete description of the problem
 - The exact wording of any error messages

Warnings, Cautions and Notes

Warning! *Warnings indicate conditions, which if not observed, can cause personal injury!*



Caution! *Cautions are included to help you avoid damaging hardware or losing data. e.g.*



There is a danger of a new battery exploding if it is incorrectly installed. Do not attempt to recharge, force open, or heat the battery. Replace the battery only with the same or equivalent type recommended by the manufacturer. Discard used batteries according to the manufacturer's instructions.

Note! *Notes provide optional additional information.*



Packing List

Before installation, please ensure the following items have been shipped:

- 1 x ARK-3510 unit
- 1 x Driver/Utility CD
- 1 x Registration and 2 years Warranty card
- 1 x China RoHS
- 1 x DVI-I to VGA adaptor
- 1 x CPU thermal grease pad

Ordering Information

Model Number	Description
ARK-3510L-00A1E	Intel 3rd Gen. Core i High Performance Fanless Embedded Box PC with 2 x 2.5" removable drive bay

Optional Accessories

For ARK-3510L

Part Number	Description
1757004519-01	ADAPTER 100-240V 84W 12V 7A W/PFC 9NA0840448 FSP
1702002600	Power cable 3-pin 180 cm, USA type
1702031801	Power cable 3-pin 180 cm, UK type
1702002605	Power cable 3-pin 180 cm, Europe type
1700000237	Power cable 3-pin 180 cm, PSE

Safety Instructions

1. Please read these safety instructions carefully.
2. Please keep this User's Manual for later reference.
3. Please disconnect this equipment from AC outlet before cleaning. Use a damp cloth. Don't use liquid or sprayed detergent for cleaning. Use moisture sheet or clothe for cleaning.
4. For pluggable equipment, the socket-outlet shall near the equipment and shall be easily accessible.
5. Please keep this equipment from humidity.
6. Lay this equipment on a reliable surface when install. A drop or fall could cause injury.
7. The openings on the enclosure are for air convection hence protecting the equipment from overheating. **DO NOT COVER THE OPENINGS.**
8. Make sure the voltage of the power source when connecting the equipment to the power outlet.
9. Place the power cord such a way that people cannot step on it. Do not place anything over the power cord.
10. All cautions and warnings on the equipment should be noted.
11. If the equipment is not used for long time, disconnect the equipment from mains to avoid being damaged by transient over-voltage.
12. Never pour any liquid into ventilation openings; this could cause fire or electrical shock.
13. Never open the equipment. For safety reasons, only qualified service personnel should open the equipment.
14. If one of the following situations arises, get the equipment checked by service personnel:
 - The power cord or plug is damaged.
 - Liquid has penetrated into the equipment.
 - The equipment has been exposed to moisture.
 - The equipment does not work well, or you cannot get it to work according to the user's manual.
 - The equipment has been dropped and damaged.
 - The equipment has obvious signs of breakage.
15. Do not leave this equipment in an environment where the storage temperature may go below -40°C (-40°F) or above 85°C (185°F). This could damage the equipment. the equipment should be in a controlled environment.
16. Caution: Danger of explosion if battery is incorrectly replaced. Replace only with the same or equivalent type recommended by the manufacturer, discard used batteries according to the manufacturer's instructions.
17. The sound pressure level at the operator's position according to IEC 704-1:1982 is no more than 70 dB (A).
18. **RESTRICTED ACCESS AREA:** The equipment should only be installed in a Restricted Access Area.
19. **DISCLAIMER:** This set of instructions is given according to IEC 704-1. Advan-tech disclaims all responsibility for the accuracy of any statements contained herein.

Contents

Chapter 1 General Introduction1

1.1	Introduction	2
1.2	Product Features.....	3
	1.2.1 General	3
	1.2.2 Display	3
	1.2.3 Ethernet	3
1.3	Chipset.....	4
	1.3.1 Functional Specification	4
	1.3.2 iManager.....	5
1.4	Mechanical Specifications.....	6
	1.4.1 Dimensions	6
	Figure 1.1 ARK-3510 Mechanical dimension drawing.....	6
	1.4.2 Weight.....	6
1.5	Power Requirement	6
	1.5.1 System Power.....	6
	1.5.2 RTC Battery	6
1.6	Environment Specification.....	7
	1.6.1 Operating Temperature.....	7
	1.6.2 Relative Humidity	7
	1.6.3 Storage Temperature.....	7
	1.6.4 Vibration during Operation	7
	1.6.5 Shock during Operation	7
	1.6.6 Safety.....	7
	1.6.7 EMC.....	7

Chapter 2 Hardware Configuration.....9

2.1	Introduction	10
2.2	Jumpers	10
	2.2.1 Jumper Description	10
	2.2.2 Jumper List	10
	Table 2.1: Jumper List of Main Board.....	10
	2.2.3 Jumper Location	11
	Figure 2.1 Jumper Layout.....	11
	2.2.4 Jumper Setting.....	11
2.3	Switch.....	14
	2.3.1 Switch List.....	14
	Table 2.2: Jumper List of Main Boar.....	14
2.4	Connectors.....	16
	2.4.1 ARK-3510 External I/O Location.....	16
	Figure 2.2 ARK-3510L Front IO connectors drawing.....	16
	Figure 2.3 ARK-3510L Rear IO connectors drawing	16
	2.4.2 ARK-3510 Front I/O connectors.....	16
	Figure 2.4 Audio connector.....	16
	Table 2.3: Audio Connector Pin Assignments	16
	Figure 2.5 USB2.0 connector	17
	Table 2.4: USB 2.0 Connector.....	17
	Figure 2.6 COM connector	17
	Table 2.5: COM Connector Pin Assignments	17
	2.4.3 ARK-3510 Rear I/O connectors	18
	Figure 2.7 Power ON/OFF Button	18
	Figure 2.8 Reset Button.....	18
	Figure 2.9 LED Indicators	18
	Figure 2.10DisplayPort connector	19

	Table 2.6: DisplayPort Connector pin assignments	19
	Figure 2.11 DVI-I Connector.....	19
	Table 2.7: DVI-I Connector pin assignments.....	19
	Figure 2.12 HDMI receptacle connector.....	20
	Table 2.8: HDMI Connector pin assignments.....	20
	Figure 2.13 USB3.0 Connector	20
	Table 2.9: USB 3.0 Connector	21
	Figure 2.14 Ethernet connector	21
	Table 2.10: Ethernet Connector Pin Assignments	21
2.5	Installation.....	22
2.5.1	CPU / Memory Installation.....	22
2.5.2	CFast / SIM Installation.....	23
2.5.3	HDD/SSD Installation	23
2.5.4	MiniPCIe module / Internal SIM holder Installation.....	24
2.5.5	CPU thermal Grease Pad.....	26
2.5.6	Memory thermal Pad	27
2.5.7	Wide operating temperature support	27

Chapter 3 BIOS Settings 29

	Figure 3.1 Setup program initial screen.....	30
3.1	Entering Setup.....	30
3.2	Main Setup.....	30
	Figure 3.2 Main setup screen	31
3.2.1	System time / System date	31
3.3	Advanced BIOS Features Setup.....	31
	Figure 3.3 Advanced BIOS features setup screen	32
3.3.1	ACPI Settings	32
	Figure 3.4 ACPI Setting.....	32
3.3.2	CPU Configuration.....	33
	Figure 3.5 CPU Configuration	33
3.3.3	SATA Configuration	34
	Figure 3.6 SATA Configuration: IDE Mode (Default).....	34
	Figure 3.7 SATA Configuration: AHCI Mode	34
	Figure 3.8 SATA Configuration: RAID Mode	35
3.3.4	PCH-FW Configuration	35
	Figure 3.9 PCH-FW Configuration.....	35
3.3.5	AMT Configuration.....	36
	Figure 3.10 AMT Configuration	36
3.3.6	USB Configuration	37
	Figure 3.11 USB Configuration.....	37
3.3.7	SMART Settings	38
	Figure 3.12 SMART Settings.....	38
3.3.8	IT8760 Super IO Configuration.....	39
	Figure 3.13 Super IO Configuration.....	39
3.3.9	Platform Misc Configuration.....	40
	Figure 3.14 Platform Misc Configuration	40
3.3.10	Embedded Controller Configuration	41
	Figure 3.15 Embedded Controller Configuration	41
3.3.11	Serial Port Console Redirection.....	42
	Figure 3.16 Serial Port Console Redirection	42
3.3.12	CPU PPM Configuration	43
	Figure 3.17 CPU PPM Configuration.....	43
3.4	Chipset.....	44
	Figure 3.18 Chipset Setup.....	44
3.4.1	PCH-IO Configuration.....	44
	Figure 3.19 PCH-IO Configuration	44
3.4.2	System Agent (SA) Configuration.....	45
	Figure 3.20 System Agent (SA) Configuration	45

	Figure 3.21 Intel IGFX Configuration	46
	Figure 3.22 LCD Control.....	47
3.5	Boot Settings.....	48
	Figure 3.23 Boot Setup Utility	48
3.6	Security Setup.....	49
	Figure 3.24 Password Configuration	49
3.7	Save & Exit.....	50
	Figure 3.25 Save & Exit.....	50

Appendix A Watchdog Timer Sample Code.....53

A.1	EC Watchdog Timer sample code	54
-----	-------------------------------------	----

Chapter 1

General Introduction

This chapter gives background information on ARK-2150 series.

1.1 Introduction

ARK-3510 is an intelligent, fanless embedded system powered by Intel 3rd Gen. Core i rPGA high performance processor with multiple I/O interface and 2 removable 2.5" HDD drive bays.

ARK-3510 offers 1 x DVI-I, 1 x DisplayPort, 1 x HDMI interface which can support independent Tri-display, 4 x USB 3.0 ports, 2 x USB 2.0 ports, 2 x Giga LAN ports, audio function, 4 x COM ports, 2 x Mini PCI sockets with SIM holders; all packed into a rugged unit and powered by an Intel® 3rd generation rPGA Core™ i7/i5/i3 processor (supporting up to 45W). The ARK-3510 IPC supports 2 x 2.5" removable SATA HDD driver bays, 1 x CFast card, and 2 x mSATA (miniPCIe slots, switch by BIOS) for storage options.

Multi-functional Design

ARK-3510 offers 1 x DVI-I, 1 x DisplayPort, 1 x HDMI interface which can support independent Tri-display, 4 x USB 3.0 ports, 2 x USB 2.0 ports, 2 x GigaLAN ports, Audio function, 4 x COM ports, and 2 x Mini PCI sockets with SIM holders; all packed into a rugged unit and powered by an Intel® 3 generation rPGA Core™ i7/i5/i3 processor (supporting up to 45W). The ARK-3510 IPC supports 2 x 2.5" removable SATA HDD driver bays, and 1 x CFast card, and 2 x mSATA (miniPCIe slots, switch by BIOS) for storage options.

Flexible Design

ARK-3510 is a rugged high performance fanless embedded box PC which can support wide-temperature ranges from -10~60C (with SSD), it supports 12 VDC for the standard model, but we reserve a wide-input power module as an optional item which can support a wider range of power from 9-34VDC. We also reserve a special design for easily customized I/O support, ARK-3510 can use any standard MIOe-2XX series modules as an option for additional and flexible I/O port support. ARK-3510 is a flexible model which can work in different environments and applications with multiple I/O and high performance support.

Built in Intelligent Management Tools - Advantech iManager & SUSIAccess

Advantech iManager provides a valuable suite of programmable APIs such as multi-level watchdog, hardware monitor, system restore, and other user-friendly interface. iManager is an intelligent self-management cross platform tool that monitors system status for problems and takes action if anything is abnormal. iManager offers a boot up guarantee in critical, low temperature environments so systems can automatically recover when voltages dip. iManager makes the whole system more reliable and more intelligent. ARK-3510 also supports Advantech's own SUSIAccess, which provides easy remote management so users can monitor, configure, and control a large number of terminals to make maintenance and system recovery simpler.

1.2 Product Features

1.2.1 General

- **CPU:** Support Intel 3rd Gen. Core i3/i5/i7 and Celeron rPGA processor (up to 45W)
- **System Chipset:** Intel QM77 I/O Controller
- **BIOS:** AMI 64-Mbit SPI Flash BIOS
- **System Memory:** DDR3 1600MHz or DDR3L 1600MHz up to 16GB
- **Watchdog Timer:** Single chip Watchdog 255-level interval timer, setup by software
- **I/O Interface:**
 - 2 x RS232, 2 x RS232/422/485
- **USB:**
 - 4 x USB 3.0 and 2 x USB 2.0 compliant ports
- **Audio:** High Definition Audio (HD), Line out, Mic-in
- **Storage:** 2 x 2.5" removable HDD drive bays (9.5mm height), 1 x CFast card, and 2 x mSATA
- **Expansion Interface:** Supports 2 x full-size Mini-PCIe (supports mSATA and with SIM holders)
- **Software API:** Advantech iManager and SUSIAccess - Remote Device Management technology

1.2.2 Display

- **Controller:** Intel HD Graphics 4000
- **Resolution:**
 - VGA: VGA Integrated in DVI-I port
 - DVI-I: 1920 x 1200 @ 60Hz
 - HDMI: Support HDMI 1.4, 1920 x 1200 @ 60Hz
 - Display Port: 2560 x 1600 @ 60Hz (Video only, and only support with 3rd gen. processor)
- **Dual Display:**
 - VGA+DVI, VGA+HDMI, VGA + DP, DVI + HDMI, DVI + DP, HDMI + DP
- **Triple Display:**
 - DVI-D + HDMI + DP

1.2.3 Ethernet

- **Chipset:**
 - LAN1 Intel 82579LM,
 - LAN2 Intel I-210IT
- **Speed:** 1000 Mbps
- **Interface:** 2 x RJ45
- **Standard:** Compliant with IEEE 802.3, IEEE 802.3u, IEEE 802.3x, IEEE 802.3y, IEEE 802.ab.

1.3 Chipset

1.3.1 Functional Specification

1.3.1.1 Processor

Processor	Support rPGA processor (up to 45W): <ul style="list-style-type: none">■ Intel Core i7-3610QE 2.3GHz with 6M L3 cache■ Intel Core i5-3610ME 2.7GHz with 3M L3 cache■ Intel Core i3-3120ME 2.4GHz with 3M L3 cache■ Intel Celeron 1020E 2.2GHz with 2M L3 cache
Memory	Supports DDR3 1600 MHz or DDRL3 1600MHz up to 16 GB 2 x 204-pin SODIMM socket type

1.3.1.2 Chipset

Internal Graphics Features	<ul style="list-style-type: none">■ DirectX 11 and OpenGL 3.0■ Display Part 1.1, HDMI 1.3a■ Supports HDCP 1.3■ Intel Display Power saving technology 6.0■ SGXS45 Power VR Core 400/640 MHz
Video Accelerator	<ul style="list-style-type: none">■ HW accelerated Media Decode: AVC/H.264, VC-1, MPEG-2■ HW accelerated Media Encode: AVC/H.264, MPEG-2
SATA Interface	Intel QM77 chip supports: <ul style="list-style-type: none">■ Supports several optional sections of Serial ATA III■ Supports SATA transfers to 600 Mbytes/sec.■ Integrated AHCI controller■ Supports mSATA socket
USB Interface	Intel QM77 chip supports: <ul style="list-style-type: none">■ xHCI Host Controller, supporting SuperSpeed USB 3.0 ports■ Two EHCI Host Controllers, supporting HighSpeed USB 2.0 ports■ Supports wake-up from sleeping states S1–S4■ Supports legacy Keyboard/Mouse software■ Maximum 500mA for each USB port
Power Management	Intel QM77 chip supports: <ul style="list-style-type: none">■ Supports ACPI 4.0a■ ACPI-defined power states (processor driven C states)■ ACPI Power Management Timer■ SMI# generation
BIOS	Intel QM77 chip supports: <ul style="list-style-type: none">■ AMI 64-Mbit EFI Flash BIOS via SPI

1.3.1.3 Others

	ITE 8760E & SMSC SCH3106 supports: <ul style="list-style-type: none"> ■ Up to 4 serial ports. ■ Supports IRQ Sharing among serial ports under Microsoft Windows OS
Serial ports	ARK-3510L <ul style="list-style-type: none"> ■ COM1, COM2 : RS-232 ■ COM3, COM4 : RS-232/422/485
Ethernet	LAN1 Intel 82579LM, LAN2 Intel I-210IT <ul style="list-style-type: none"> ■ Compliant with IEEE 802.3, IEEE 802.3u, IEEE 802.3x, IEEE 802.3y, IEEE 802.ab. ■ Support 10/100/1000 Mbps. LAN Connectors: Phone Jack RJ45 8P 90D(F)
Audio	Audio Codec: Realtek ALC892: <ul style="list-style-type: none"> ■ Compliant with HD Audio specifications ■ Supports 16/20/24-bit DAC and 16/20/24-bit ADC resolution ■ Supports: Speak-out, Mic-in Audio Connectors: Ear Phone Jack * 2
Battery backup	<ul style="list-style-type: none"> ■ BATTERY 3V/210 mAh with WIRE x 1

1.3.2 iManager

iManager	
Sequence control	Supported
DIO	8-bit programmable DIO
Watchdog timer	Multi Level WDT (set by Advantech iManager) Programmable 1-255 sec / min
Hardware monitor	CPU Temperature / input Current / input Voltage
Power saving	Deep sleep S5 mode / Smart Fan / Back light control
System information	Running HR / Boot record

1.4 Mechanical Specifications

1.4.1 Dimensions

290[11.4] x 90[3.54] x 232[9.13] (Unit: mm [Inch])

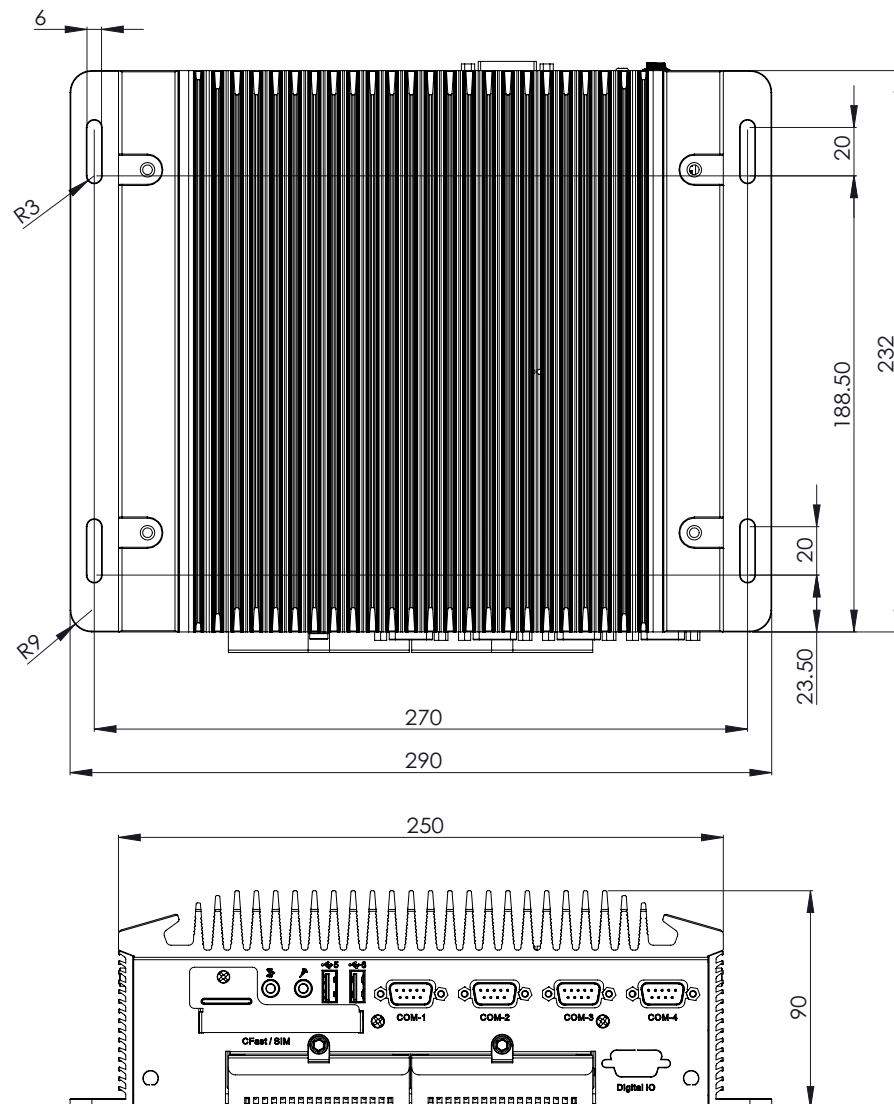

Figure 1.1 ARK-3510 Mechanical dimension drawing

1.4.2 Weight

4.63kg (10.19lb)

1.5 Power Requirement

1.5.1 System Power

- Minimum power input:
 - ARK-3510L: DC12V, 7A

1.5.2 RTC Battery

- Lithium 3 V/210 mA

1.6 Environment Specification

1.6.1 Operating Temperature

- With Industrial Grade SSD/Cfast: -10 ~ 60° C (-14~140° F), with air flow, speed=0.7 m/sec
- With 2.5-inch hard disk 0 to 50° C (32~122° F), with air flow, speed=0.7 m/sec

1.6.2 Relative Humidity

- 95% @ 40° C (non-condensing)

1.6.3 Storage Temperature

- -40 ~ 85° C (-40 ~ 185° F)

1.6.4 Vibration during Operation

- When system is equipped with SSD/mSATA: 3Grms, IEC 60068-2-64, random, 5 ~ 500 Hz, 1hr/axis, x,y,z 3 axes.

1.6.5 Shock during Operation

- When system is equipped with SSD/mSATA: 50G, IEC 60068-2-27, half sine, 11 ms duration.

1.6.6 Safety

- UL, CCC, BSMI

1.6.7 EMC

- CE, FCC, CCC, BSMI

Chapter 2

Hardware
Configuration

2.1 Introduction

The following sections show the internal jumpers setting and the external connectors pin assignment for application.

2.2 Jumpers

2.2.1 Jumper Description

You may configure ARK-3510 to match the needs of your application by setting jumpers. A jumper is a metal bridge used to close an electric circuit. It consists of two metal pins and a small metal clip (often protected by a plastic cover) that slides over the pins to connect them. To close a jumper, you connect the pins with the clip. To open a jumper, you remove the clip. Sometimes a jumper will have three pins, labeled 1, 2 and 3. In this case you would connect either pins 1 and 2, or 2 and 3.

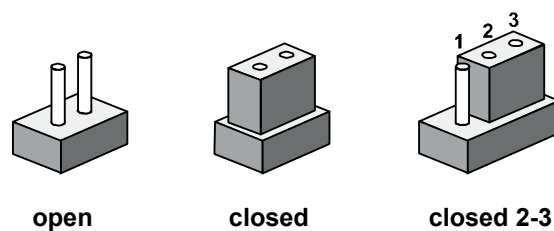

The jumper settings are schematically depicted in this manual as follows.

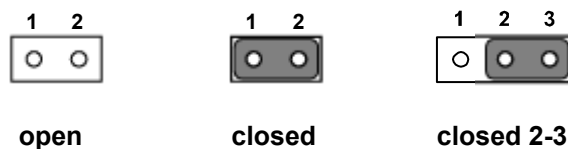

A pair of needle-nose pliers may be helpful when working with jumpers. If you have any doubts about the best hardware configuration for your application, contact your local distributor or sales representative before you make any changes. Generally, you simply need a standard cable to make most connections.

2.2.2 Jumper List

Table 2.1: Jumper List of Main Board

J1	DDR3/DDR3L Setting
J2	Auto Power On Setting
J3	COM4 RS232/422/485 Setting
J4	COM3 RS232/422/485 Setting
J5	COM4 RS232/422/485 Setting
J6	COM3 RS232/422/485 Setting
J7	COM4 RS232/422/485 Setting
J8	COM3 RS232/422/485 Setting
J9	Clear CMOS

2.2.3 Jumper Location

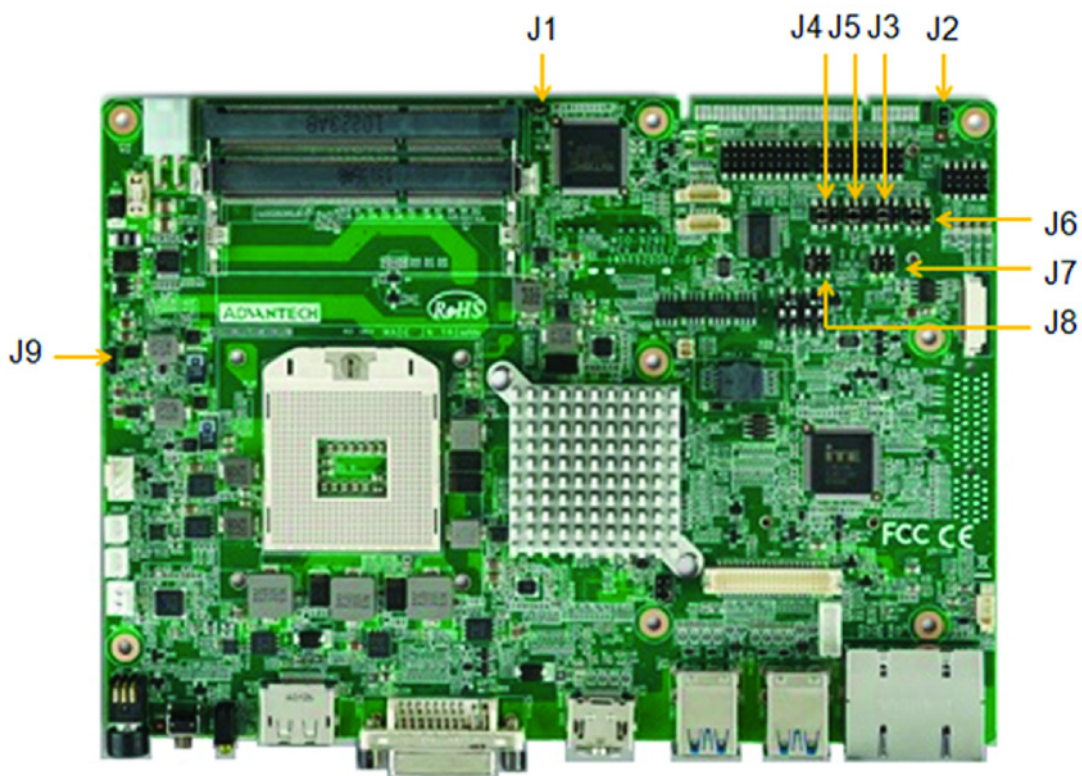

Figure 2.1 Jumper Layout

2.2.4 Jumper Setting

At Mother Board

2.2.4.1 DDR3/DDR3L setting (J1)

J1	DDR3/DDR3L Setting
Part Number	1653002101
Footprint	HD_2x1P_79_D
Description	
Setting	Function
NC	DDR3 Memory module (Default)
(1-2)	DDR3L Memory module



2.2.4.2 Auto Power On Setting (J2)

J2	Auto Power On Setting
Part Number	1653002101
Footprint	HD_2x1P_79_D
Description	
Setting	Function

NC	Power Button for Power On (Default)
(1-2)	Auto Power On



2.2.4.3 COM4 RS232/422/485 setting (J3)

* Please check J5/J7 for COM4 RS232/422/485 setting as well

J3	COM4 RS232/422/485 Setting
Part Number	1653003260
Footprint	HD_3x2P_79
Description	
Setting	Function
(1-3)*(2-4)	COM4 RS232 (Default)
(3-5)*(4-6)	COM4 RS422/485

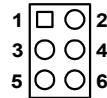

2.2.4.4 COM3 RS232/422/485 setting (J4)

* Please check J6/J8 for COM3 RS232/422/485 setting as well

J4	COM3 RS232/422/485 Setting
Part Number	1653003260
Footprint	HD_3x2P_79
Description	
Setting	Function
(1-3)*(2-4)	COM3 RS232 (Default)
(3-5)*(4-6)	COM3 RS422/485

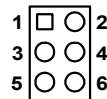

2.2.4.5 COM4 RS232/422/485 setting (J5)

* Please check J3/J7 for COM4 RS232/422/485 setting as well

J5	COM4 RS232/422/485 Setting
Part Number	1653003260
Footprint	HD_3x2P_79
Description	
Setting	Function
(1-3)*(2-4)	COM4 RS232 (Default)
(3-5)*(4-6)	COM4 RS422/485

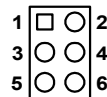

2.2.4.6 COM3 RS232/422/485 setting (J6)

* Please check J4/J8 for COM3 RS232/422/485 setting as well

J6	COM3 RS232/422/485 Setting
Part Number	1653003260
Footprint	HD_3x2P_79
Description	
Setting	Function
(1-3)*(2-4)	COM3 RS232 (Default)
(3-5)*(4-6)	COM3 RS422/485

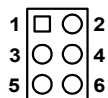
**2.2.4.7 COM4 RS232/422/485 setting (J7)**

* Please check J3/J5 for COM4 RS232/422/485 setting as well

J7	COM4 RS232/422/485 Setting
Part Number	1653003260
Footprint	HD_3x2P_79
Description	
Setting	Function
(1-2)	COM4 RS232 (Default)
(3-4)	COM4 RS485
(5-6)	COM4 RS422

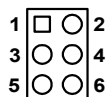
**2.2.4.8 COM3 RS232/422/485 setting (J8)**

* Please check J4/J6 for COM3 RS232/422/485 setting as well

J8	COM3 RS232/422/485 Setting
Part Number	1653003260
Footprint	HD_3x2P_79
Description	
Setting	Function
(1-2)	COM3 RS232 (Default)
(3-4)	COM3 RS485
(5-6)	COM3 RS422

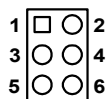
**2.2.4.9 Clear CMOS (J9)**

J9	Clear CMOS
Part Number	1653003101

Footprint	HD_3x1P_79_D
Description	
Setting	Function
(1-2)	Normal (Default)
(2-3)	Clear CMOS

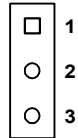

2.3 Switch

2.3.1 Switch List

Table 2.2: Jumper List of Main Boar

SW1	COM4 RS485 Termination PU/PD
SW2	COM3 RS485 Termination PU/PD
SW5	PCIe/mSATA selection
SW6	PCIe/mSATA selection

2.3.1.1 COM4 RS485 Termination PU/PD

SW1	COM4 RS485 Termination PU/PD
Part Number	1600003089-01
Footprint	SW_2x2P_100_198x378
Description	
Setting	Function
(OFF)1*(OFF)2	NO TERMINATION (Default)
(OFF)1*(ON)3	TERMINATION PU
(OFF)2*(ON)4	TERMINATION PD

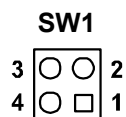

2.3.1.2 COM3 RS485 Termination PU/PD

SW2	COM3 RS485 Termination PU/PD
Part Number	1600003089-01
Footprint	SW_2x2P_100_198x378
Description	
Setting	Function
(OFF)1*(OFF)2	NO TERMINATION (Default)
(OFF)1*(ON)3	TERMINATION PU
(OFF)2*(ON)4	TERMINATION PD

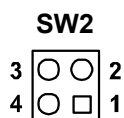

2.3.1.3 PCIE/mSATA Selection

SW5	PCIE/mSATA Selection
Part Number	1600003089-01
Footprint	SW_2x2P_100_198x378
Description	
Setting	Function
(OFF)1*(ON)3	AUTO-DETECTION (Default)
(OFF)1*(OFF)2	PCIE CARD
(OFF)2*(ON)4	mSATA

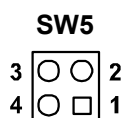

2.3.1.4 PCIE/mSATA Selection

SW6	PCIE/mSATA Selection
Part Number	1600003089-01
Footprint	SW_2x2P_100_198x378
Description	
Setting	Function
(OFF)1*(ON)3	AUTO-DETECTION (Default)
(OFF)1*(OFF)2	PCIE CARD
(OFF)2*(ON)4	mSATA

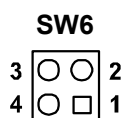

2.4 Connectors

2.4.1 ARK-3510 External I/O Location

ARK-3510L:

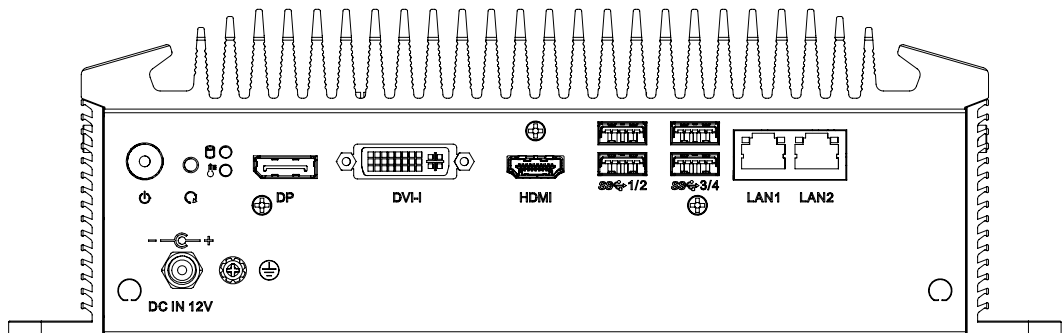

Figure 2.2 ARK-3510L Front IO connectors drawing

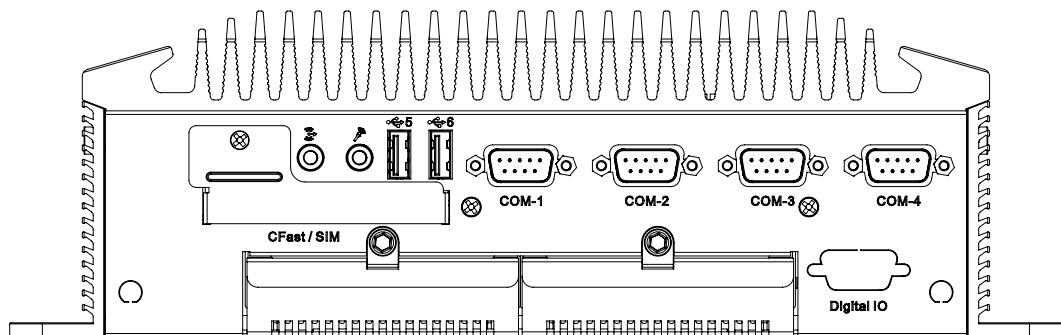

Figure 2.3 ARK-3510L Rear IO connectors drawing

2.4.2 ARK-3510 Front I/O connectors

2.4.2.1 Audio Connector

ARK-3510 offers stereo audio ports by three phone jack connectors of Line_Out, Line_In, Mic_In. The audio chip is controlled by ALC892, and it's compliant with Aza-lea standard.

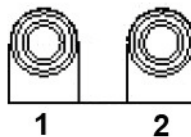

Figure 2.4 Audio connector

Table 2.3: Audio Connector Pin Assignments

Pin	Audio Signal Name
1	Line out
2	Mic in

2.4.2.2 USB2.0 Connector

ARK-3510 provides up to four USB2.0 interface connectors, which give complete Plug & Play and hot swapping for up to 127 external devices. The USB interface

complies with USB UHCI, Rev. 2.0 compliant. The USB interface can be disabled in the system BIOS setup. Please refer to Table. 2.7 for its pin assignments. The USB connectors are used to connect any device that conforms to the USB interface. Most digital devices conform to this standard. The USB interface supports Plug and Play.

* Support power on/off switch in suspend mode (By BIOS setting, please refer to BIOS setting chapter 3.3.10)

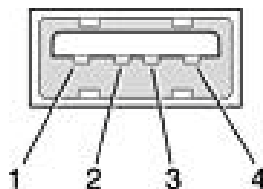

Figure 2.5 USB2.0 connector

Table 2.4: USB 2.0 Connector

Pin	Signal Name	Pin	Signal Name
1	+5V	2	USB_data-
3	USB_data+	4	GND

2.4.2.3 COM Connector

ARK-3510 provides up to four D-sub 9-pin connectors, which offers RS-232/422/485 serial communication interface ports. Default setting is RS-232, if you want to use RS-422/485, you just need to change BIOS setting. The BIOS setting of RS-232/422/485 can be found in Chapter 3.3.8 & 3.3.9.

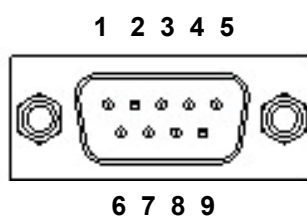

Figure 2.6 COM connector

Table 2.5: COM Connector Pin Assignments

Pin	RS-232	RS-422	RS-485
	Signal Name	Signal Name	Signal Name
1	DCD	Tx-	DATA-
2	RxD	Tx+	DATA+
3	TxD	Rx+	NC
4	DTR	Rx-	NC
5	GND	GND	GND
6	DSR	NC	NC
7	RTS	NC	NC
8	CTS	NC	NC
9	RI	NC	NC

Note! NC represents “No Connection”.



2.4.3 ARK-3510 Rear I/O connectors

2.4.3.1 Power On/Off Button

ARK-3510 has a Power On/Off button with LED indicators on the front side that show On status (Green LED) and Off/Suspend status (Orange LED). The Power button supports dual functions: Soft Power -On/Off (Instant off or Delay 4 Seconds then off), and Suspend.



Figure 2.7 Power ON/OFF Button

2.4.3.2 Reset Button

ARK-3510 has a Reset button on the front panel. Press the button to activate the reset function.



Figure 2.8 Reset Button

2.4.3.3 LED Indicators

There are two LEDs on the front panel that indicate system status: The thermal LED is for system thermal alarm status; and HDD LED is for HDD and compact flash disk status.



Figure 2.9 LED Indicators

2.4.3.4 DisplayPort Connector

An integrated, 20-pin receptacle connector DisplayPort Interface is provided. The DisplayPort link supports resolutions up to 2560 x 1600@60Hz. This port is transferred by Intel eDP, there is no audio and hot plug support. And this DisplayPort is supported by 3rd Gen Intel Core I processor only.

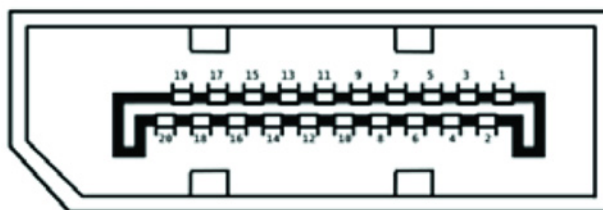

Figure 2.10 DisplayPort connector

Table 2.6: DisplayPort Connector pin assignments

Pin	Signal Name	Pin	Signal Name
1	ML_Lane 0 (p)	2	GND
3	ML_Lane 0 (n)	4	ML_Lane 1 (p)
5	GND	6	ML_Lane 1 (n)
7	ML_Lane 2 (p)	8	GND
9	ML_Lane 2 (n)	10	ML_Lane 3 (p)
11	GND	12	ML_Lane 3 (n)
13	CONFIG1	14	CONFIG2
15	AUX CH (p)	16	GND
17	AUX CH (n)	18	Hot Plug
19	Return	20	DP_PWR

2.4.3.5 Digital Visual Interface Connector (DVI-I)

The ARK-3510 offers an integrated D-sub 24-pin female DVI-I Digital Visual Interface connector; it carries integrated analog and digital video signals. This supports high-speed, high-resolution digital displays and traditional analog displays.

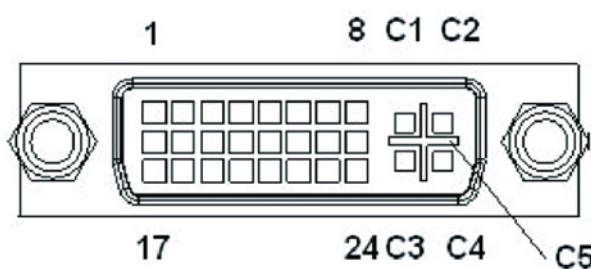

Figure 2.11 DVI-I Connector

Table 2.7: DVI-I Connector pin assignments

Pin	Signal Name	Pin	Signal Name
1	TMDS Data 2-	2	TMDS Data 2+
3	TMDS Data 2/4 shield	4	TMDS Data 4-
5	TMDS Data 4+	6	DDC clock
7	DDC data	8	Analog vertical sync
9	TMDS Data 1-	10	TMDS Data 1+
11	TMDS Data 1/3 shield	12	TMDS Data 3-
13	TMDS Data 3+	14	+5V
15	GND	16	Hot plug detect

Table 2.7: DVI-I Connector pin assignments

17	TMDS Data 0-	18	TMDS Data 0+
19	TMDS Data 0/5 shield	20	TMDS Data 5-
21	TMDS Data 5+	22	TMDS clock shield
23	TMDS clock+	24	TMDS clock-
C1	Analog red	C2	Analog green
C3	Analog blue	C4	Analog horizontal sync
C5	Analog GND		

2.4.3.6 HDMI Connector

An integrated, 19-pin receptacle connector HDMI Type A Interface is provided. The HDMI link supports resolutions up to 2560x1600@60Hz.

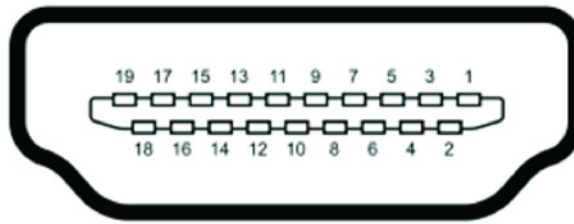
**Figure 2.12 HDMI receptacle connector****Table 2.8: HDMI Connector pin assignments**

Pin	Signal Name	Pin	Signal Name
1	TMDS Data 2+	2	TMDS Data 2 shield
3	TMDS Data 2-	4	TMDS Data 1+
5	TMDS Data 1 shield	6	TMDS Data 1-
7	TMDS Data 0+	8	TMDS Data 0 shield
9	TMDS Data 0-	10	TMDS clock+
11	TMDS clock shield	12	TMDS clock-
13	CEC	14	Reserved
15	SCL	16	SDA
17	DDC/CEC Ground	18	+5V
19	Hot Plug Detect		

2.4.3.7 USB3.0 Connector

The USB port USB port 1, 2, 3, 4 of ARK-3510 supports USB 3.0 interface, which gives complete Plug & Play and hot swapping for up to 127 external devices. The USB interface complies with USB UHCI, Rev. 3.0 compliant. Please refer to Table 2.7 for its pin assignments. USB 3.0 connectors contain legacy pins to interface to USB 2.0 devices, and a new set of pins for USB 3.0 connectivity (both sets reside in the same connector).

**Figure 2.13 USB3.0 Connector**

Table 2.9: USB 3.0 Connector

Pin	Signal Name	Pin	Signal Name
1	+5V	2	USB_data-
3	USB_data+	4	GND
5	SSRX-	6	SSRX+
7	GND	8	SSTX-
9	SSTX+		

2.4.3.8 Ethernet Connector (LAN)

ARK-3510 is equipped with up to four Ethernet controllers that are fully compliant with IEEE 802.3u 10/100/1000 Mbps CSMA/CD standards. The Ethernet port provides a standard RJ-45 jack connector with LED indicators on the front side to show its Active/Link status (Green LED) and Speed status (Yellow LED).

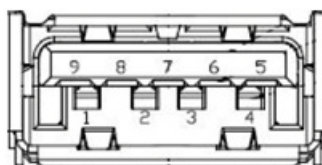
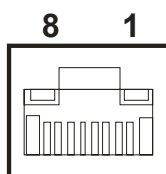
**Figure 2.14 Ethernet connector****Table 2.10: Ethernet Connector Pin Assignments**

Pin	10/100/1000BaseT Signal Name
1	TX+
2	TX-
3	RX+
4	MDI2+
5	MDI2-
6	RX-
7	MDI3+
8	MDI3-

2.5 Installation

2.5.1 CPU / Memory Installation

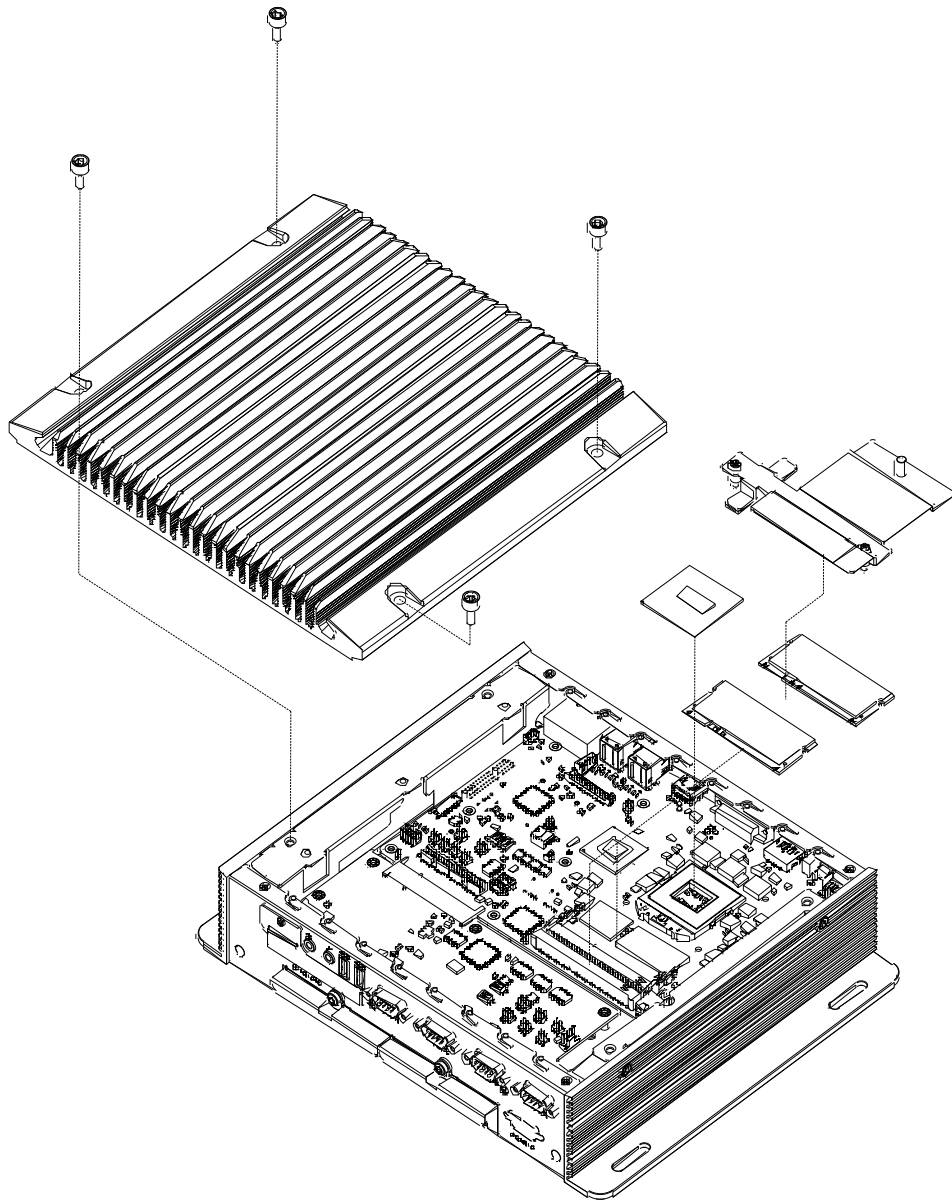

1. Unscrew the 4 screws on the top cover, and remove the top cover
2. Install the CPU on the socket, and screw to the lock on the socket
3. Unscrew 2 screws on memory bracket
4. Install the memory into the system.
5. Screw the 2 screws back onto the memory bracket with the M/B
6. Recover the top chassis

2.5.2 CFast / SIM Installation

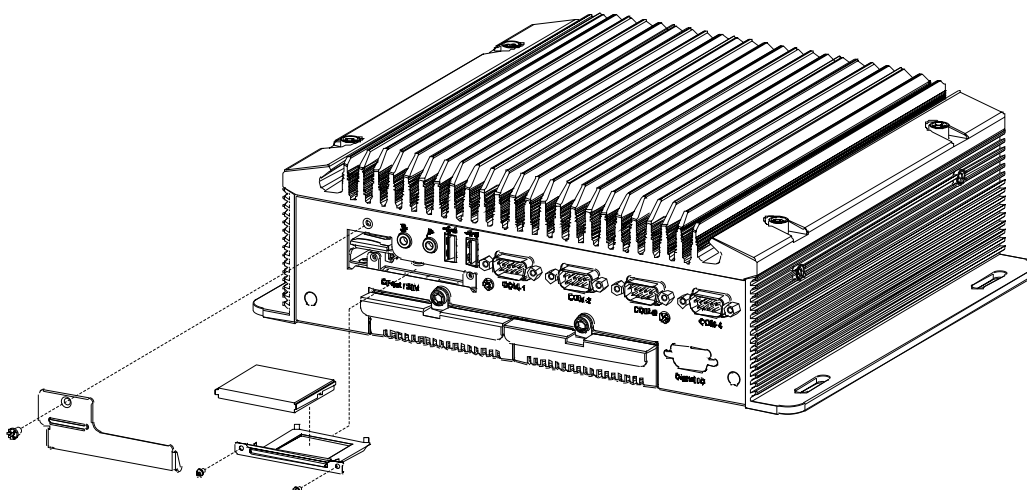

1. Unscrew the 1 screw on the cover of front panel
2. Unscrew the 2 screws on the CFast bracket
3. Pull the bracket out and remove the dummy card.
4. Put the CFast card on the bracket, and push the bracket back to the system
5. Screw the 2 screws back to the CFast bracket with the system
6. Push the SIM card in the SIM holder (Link to miniPCIe CN38 slot)
7. Screw the cover back to the front panel.

2.5.3 HDD/SSD Installation

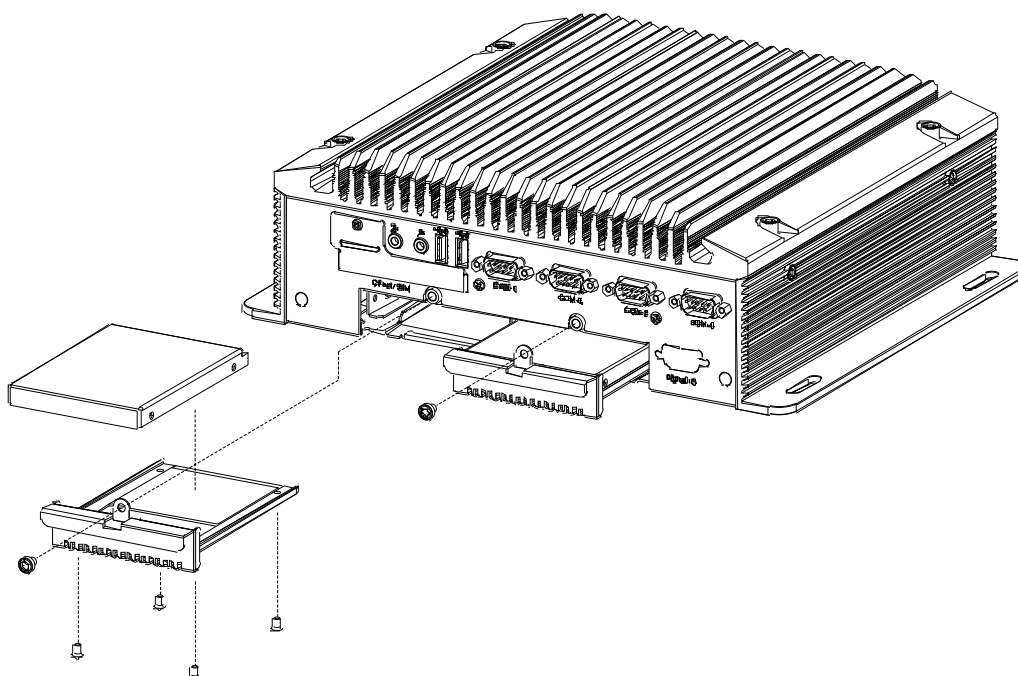

1. Unscrew 1 screw on the removable drive bay
2. Pull the removable drive bay out
3. Put the HDD thermal pad on the drive bay and screw the HDD/SSD on the removable drive bay through 4 screws on the heatsink bottom
4. Push the removable drive bay back to the system
5. Screw 1 screw on the removable bay with the front panel

2.5.4 MiniPCle module / Internal SIM holder Installation

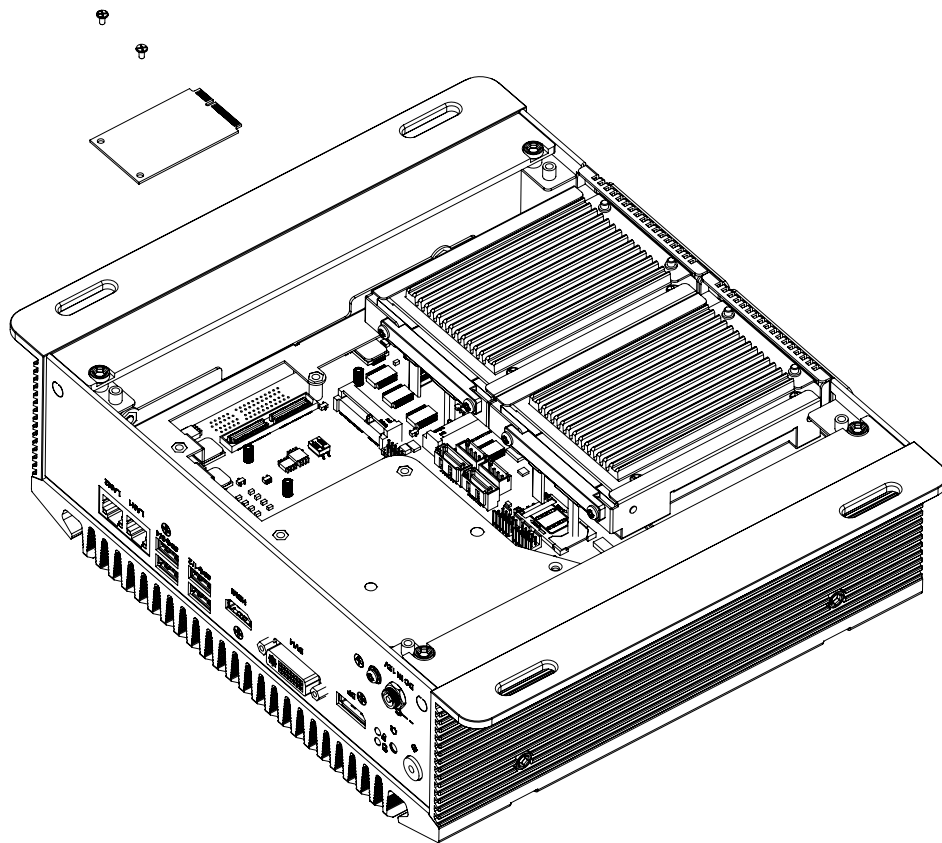

1. Unscrew 4 screws on the bottom cover, and remove the bottom cover.
2. Install the miniPCle module (CN38) and screw 2 screws on the module. (This module is connected to front panel SIM holder).

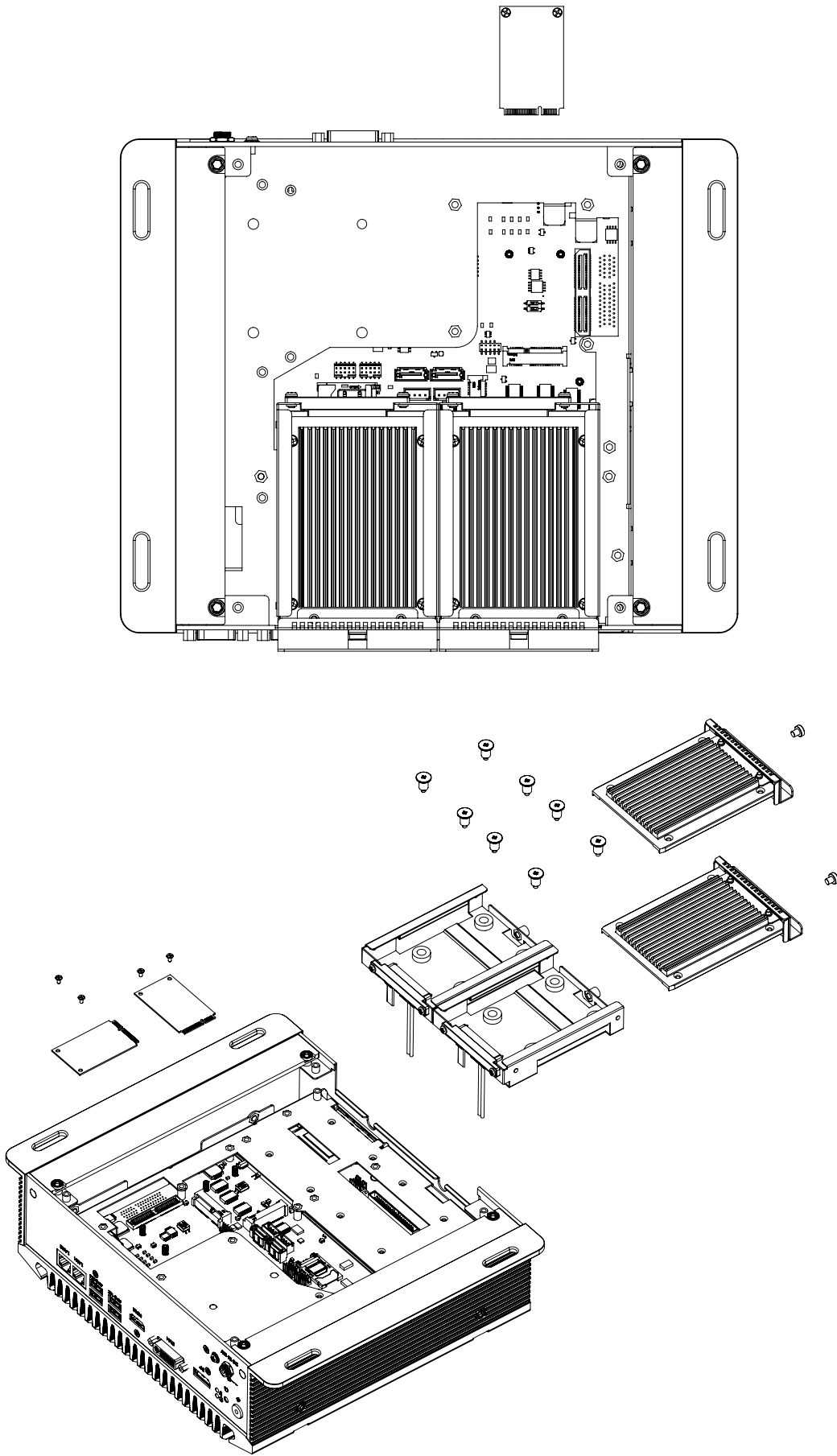

1. Unscrew 1 screw on the removable drive bay.
2. Pull the removable drive bay out.
3. Unscrew 4 screws on the bottom cover, and remove the bottom cover.
4. Unscrew 8 screws on the HDD bracket and remove the HDD bracket.
5. Install the miniPCIe module and screw the 2 screws on the module (CN29) which is under the HDD bracket. (This module is connected to the internal SIM holder CN36 SIM1)
6. Install the SIM card in the internal SIM holder (CN36 SIM1)

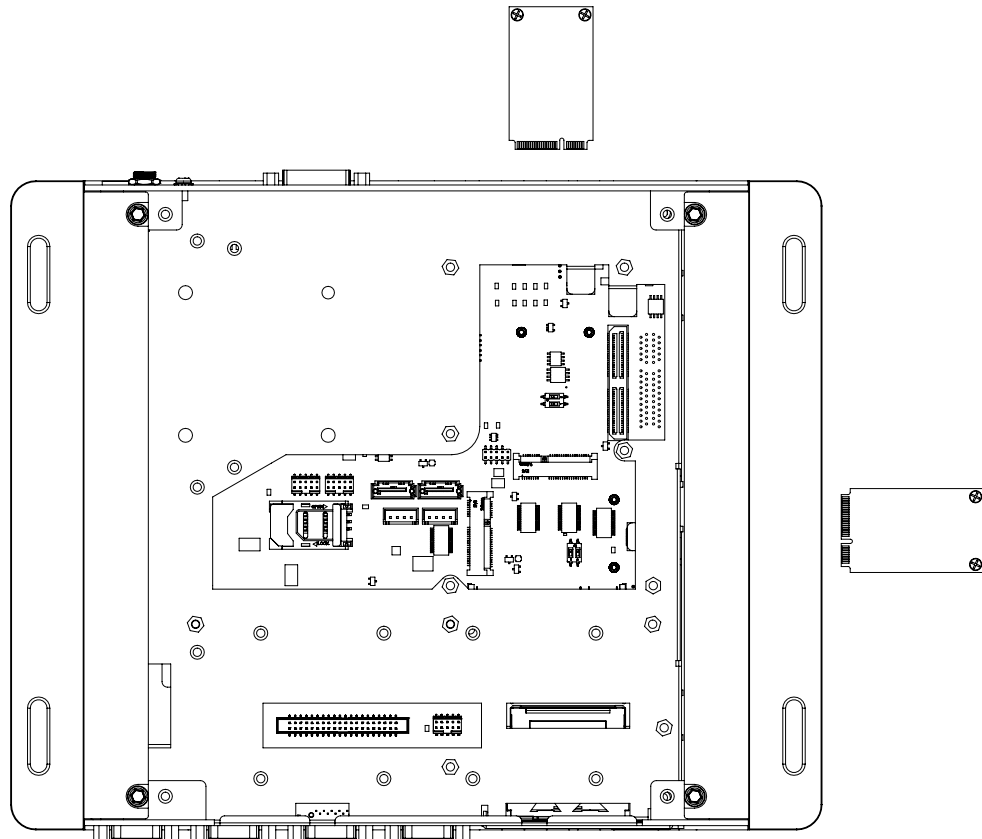

7. Screw the 8 screws on HDD bracket
8. Screw the 4 screws on the bottom cover
9. Push back the removable drive bays, and screw the 2 screws on the front panel.

2.5.5 CPU thermal Grease Pad

CPU thermal grease pad is one of the key components of ARK-3510 thermal design. Always use the grease pad provided by Advantech. The P/N of the grease pad is:

Part Number	Description
-------------	-------------

1990020828N001	Thermal-Pad D27*0.25 K=3 TP HW-PCM45Fφ27*0.25
----------------	---

To ensure the best thermal performance, it is recommended to replace the thermal grease for CPU thermal pole each time the top cover is opened.

1. To replace the thermal grease, clean up the CPU thermal pole by using paper tissue or soft cloth. DO NOT USE any kind of solvent to clean the thermal pole as this may damage the thermal grease inside the thermal pole.
2. Gently remove one of the protective papers on the grease pad and apply the grease to the CPU thermal pole. Press onto the grease pad for 30 seconds, then remove the protective paper gently from the grease pad.



2.5.6 Memory thermal Pad

The memory thermal pad is one of the key components of ARK-3510's thermal design. Always use the thermal pad provided by Advantech. The P/N of the thermal pad is:

Part Number	Description
-------------	-------------

1990018953T001	Thermal-Pad 59X16X1.0mm K=1.2 TP Fujipoly XR-HI
----------------	---

To ensure the best thermal performance, please always make sure the memory thermal pad is well taped between the memory bracket and memory module. And please make sure the memory thermal is well taped between the memory bracket and top cover as well.

And we suggest you to choose the I-grade memory module if you will use the unit in high temperature operating environments.



2.5.7 Wide operating temperature support

To make sure the system works well, please ensure your peripherals are i-grade which can support wide temperature operation (<0C, or >40C).

Chapter 3

BIOS Settings

AMIBIOS has been integrated into many motherboards for over a decade. With the AMIBIOS Setup program, users can modify BIOS settings and control various system features. This chapter describes the basic navigation of the ARK-3510 BIOS setup screens.

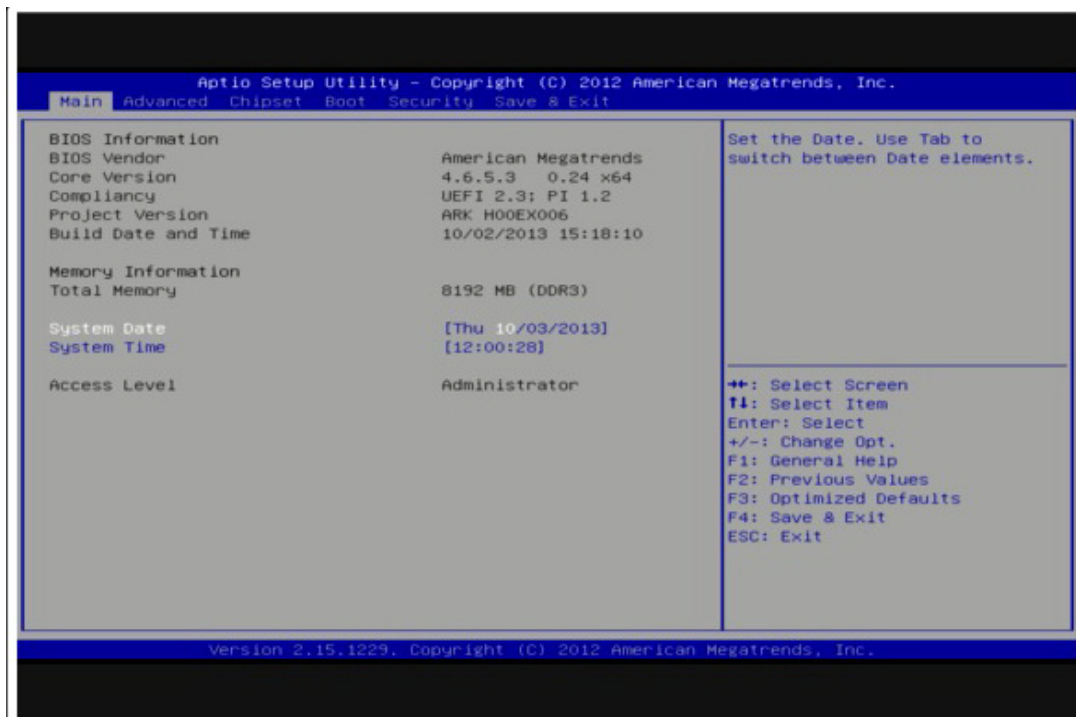

Figure 3.1 Setup program initial screen

AMI's BIOS ROM has a built-in Setup program that allows users to modify the basic system configuration. This information is stored in flash ROM so it retains the Setup information when the power is turned off.

3.1 Entering Setup

Turn on the computer and then press <F2> or to enter Setup menu.

3.2 Main Setup

When users first enter the BIOS Setup Utility, users will enter the Main setup screen. Users can always return to the Main setup screen by selecting the Main tab. There are two Main Setup options. They are described in this section. The Main BIOS Setup screen is shown below.

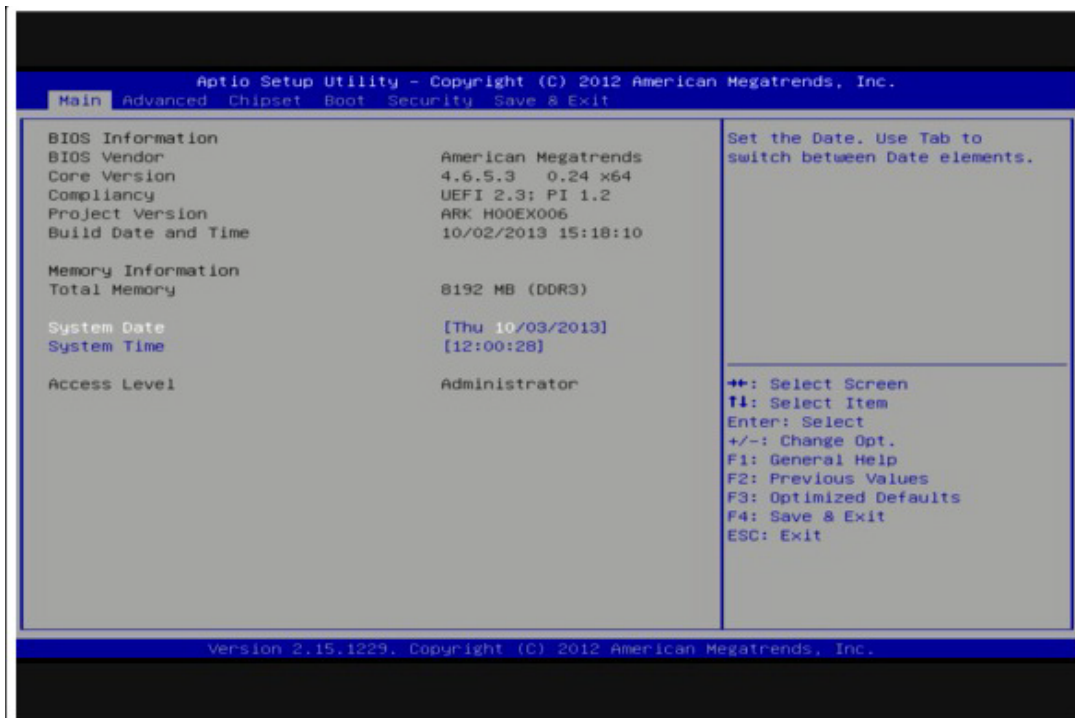

Figure 3.2 Main setup screen

The Main BIOS setup screen has two main frames. The left frame displays all the options that can be configured. Grayed-out options cannot be configured; options in blue can. The right frame displays the key legend.

Above the key legend is an area reserved for a text message. When an option is selected in the left frame, it is highlighted in white. Often a text message will accompany it.

3.2.1 System time / System date

Use this option to change the system time and date. Highlight System Time or System Date using the <Arrow> keys. Enter new values through the keyboard. Press the <Tab> key or the <Arrow> keys to move between fields. The date must be entered in MM/DD/YY format. The time must be entered in HH:MM:SS format.

3.3 Advanced BIOS Features Setup

Select the Advanced tab from the ARK-3510 setup screen to enter the Advanced BIOS Setup screen. Users can select any item in the left frame of the screen, such as CPU Configuration, to go to the sub menu for that item. Users can display an Advanced BIOS Setup option by highlighting it using the <Arrow> keys. All Advanced BIOS Setup options are described in this section. The Advanced BIOS Setup screens are shown below. The sub menus are described on the following pages.

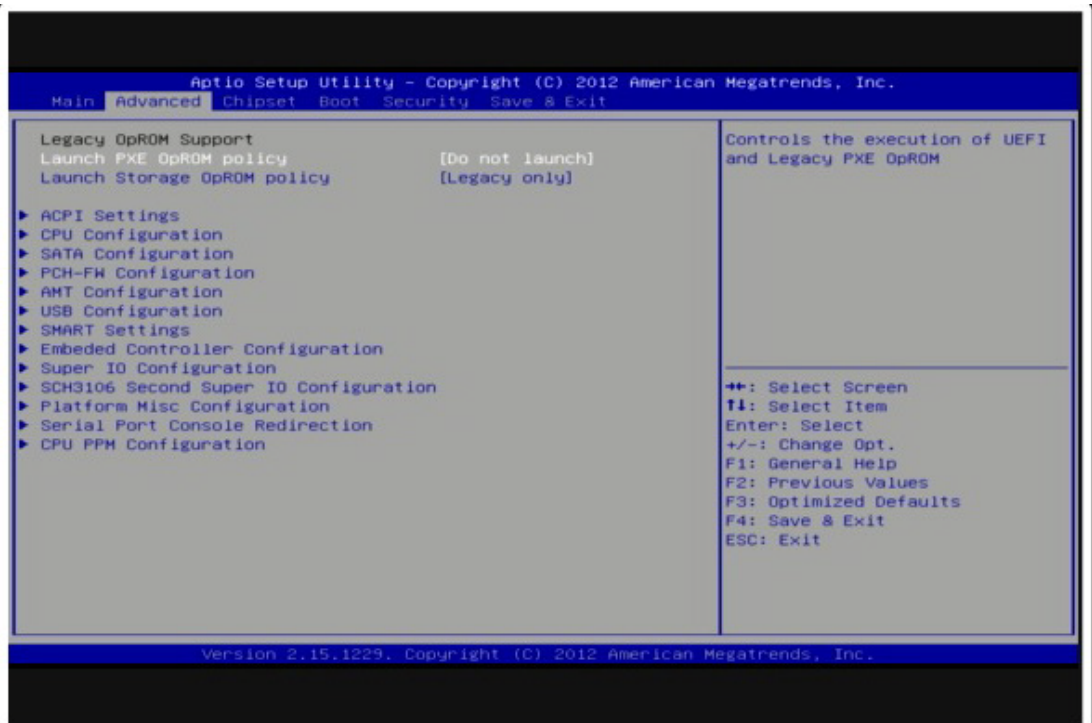

Figure 3.3 Advanced BIOS features setup screen

3.3.1 ACPI Settings

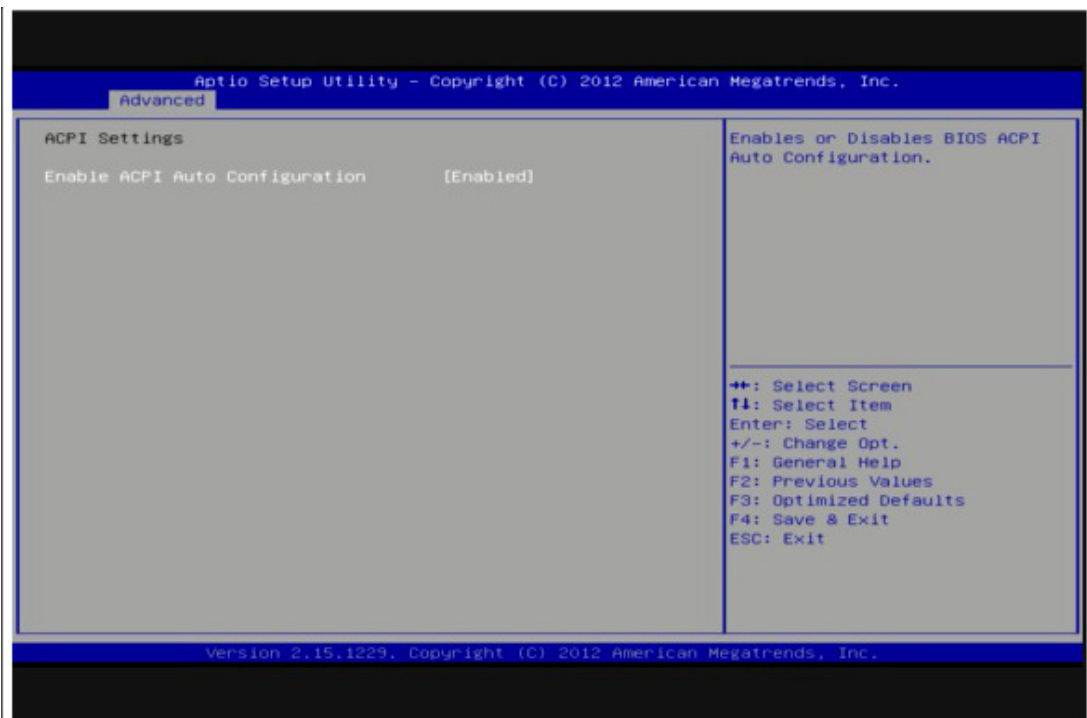

Figure 3.4 ACPI Setting

Enable ACPI Auto Configuration

This item allows users to enable or disable BIOS ACPI auto configuration.

Enable Hibernation

This item allows users to enable or disable hibernation.

ACPI Sleep State

This item allows users to set the ACPI sleep state.

Lock Legacy Resources

This item allows users to lock legacy devices' resources.

S3 Video Repost

This item allows users to enable or disable VBIOS run after S3 resume.

3.3.2 CPU Configuration

Figure 3.5 CPU Configuration

Hyper Threading Technology

This item allows users to enable or disable Intel® Hyper Threading technology.

Active Processor Cores

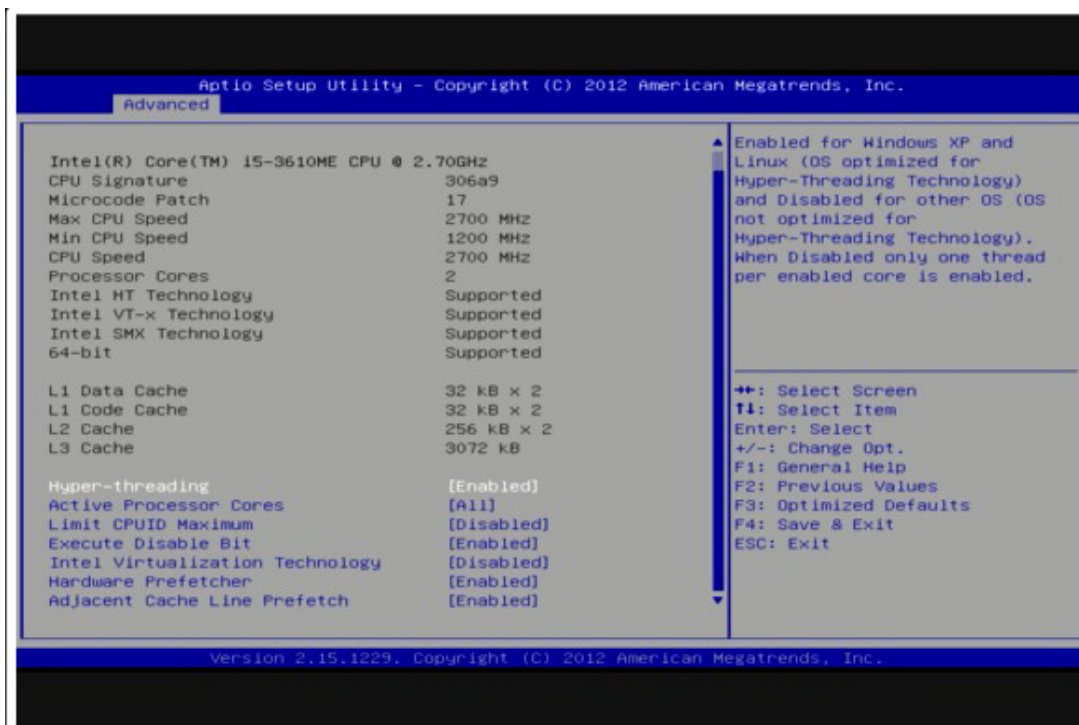
This item allows users to set how many processor cores should be active.

Limit CPUID Maximum

This item allows users to limit the maximum value of CPUID.

Execute Disable Bit

This item allows users to enable or disable the No-Execution page protection technology.

Intel Virtualization Technology

This item allows users to enable or disable the intel virtualization technology.

Hardware Prefetcher

This item allows users to enable or disable the hardware prefetcher feature.

Adjacent Cache Line Prefetch

This item allows users to enable or disable the adjacent cache line prefetch feature.

3.3.3 SATA Configuration

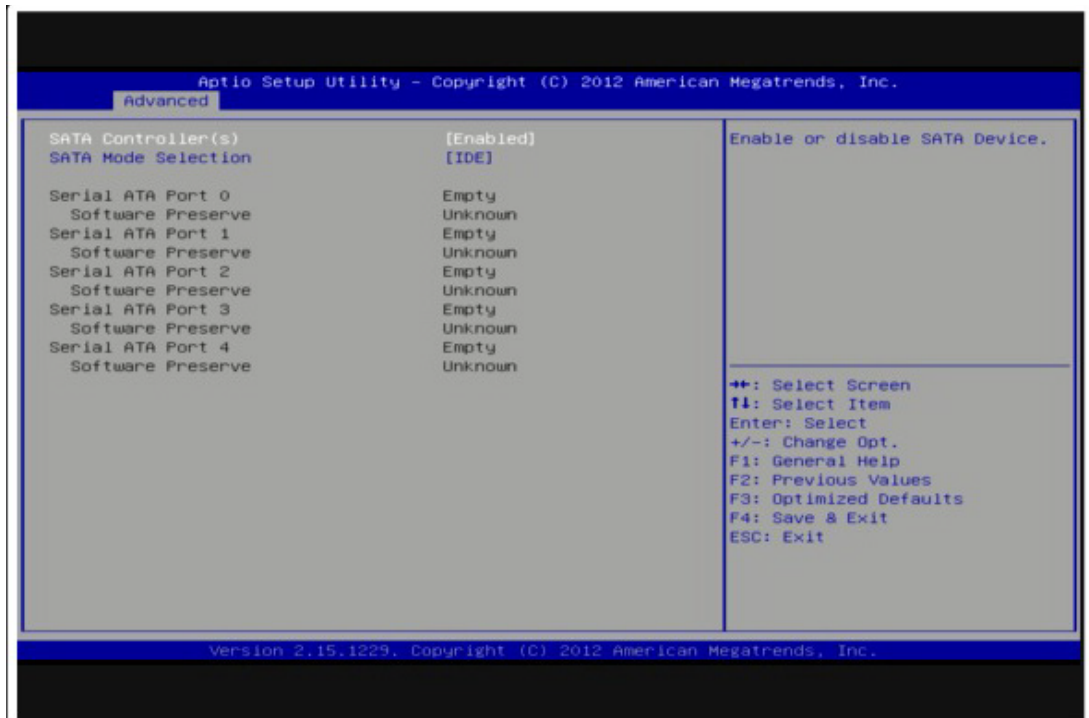

Figure 3.6 SATA Configuration: IDE Mode (Default)

SATA Controller(s)

This item allows users to enable or disable the SATA controller(s).

SATA Mode Selection

This item allows users to select mode of SATA controller(s).

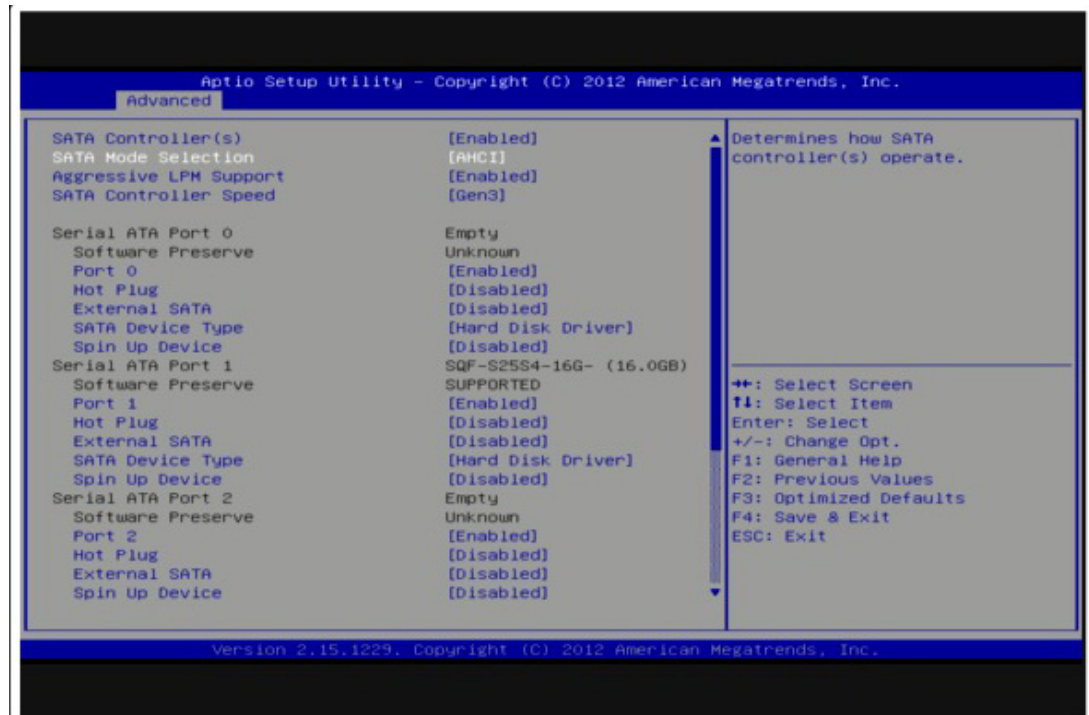

Figure 3.7 SATA Configuration: AHCI Mode

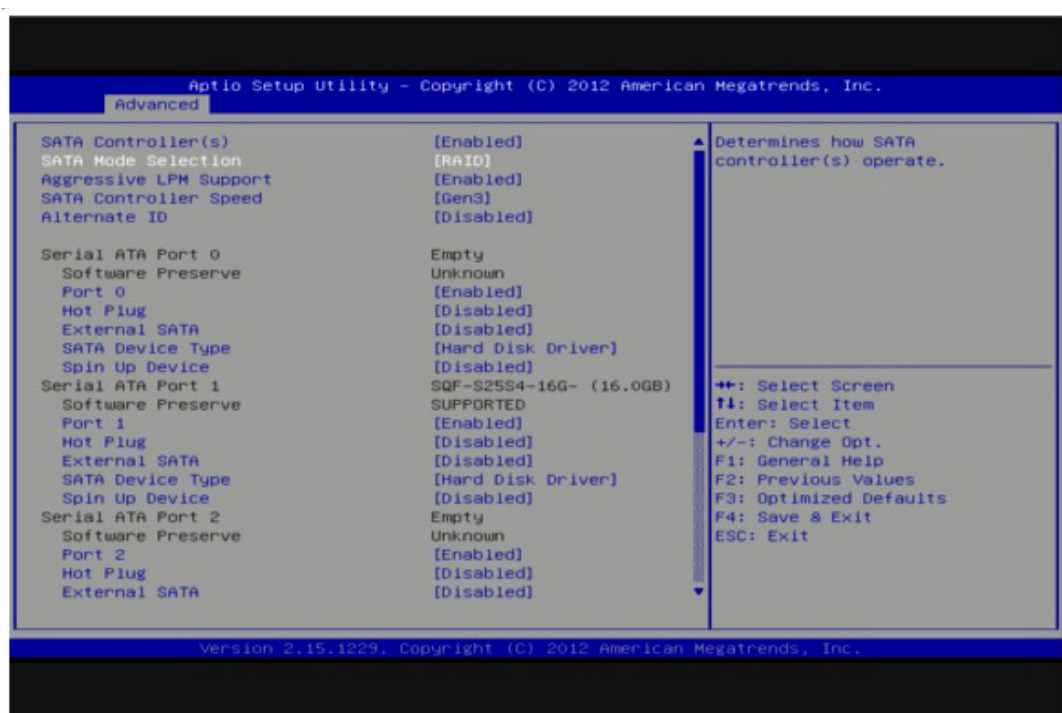

Figure 3.8 SATA Configuration: RAID Mode

RAID Mode Selection

This item allows users to select mode of RAID function (Support 0, 1, 5, 10).

3.3.4 PCH-FW Configuration

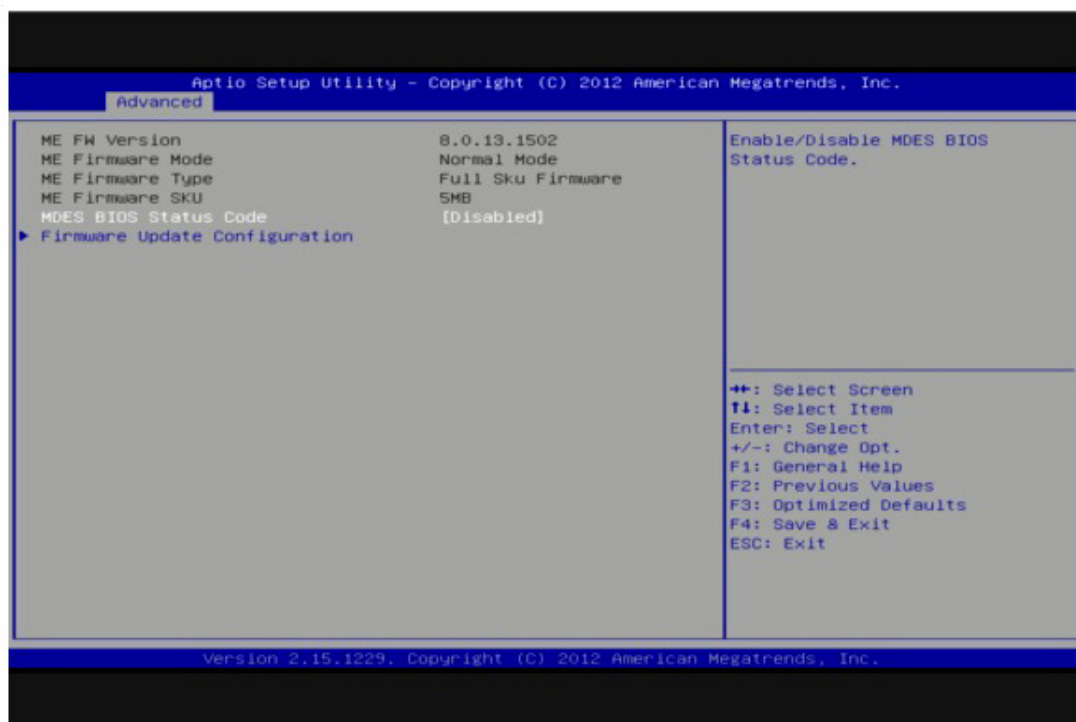

Figure 3.9 PCH-FW Configuration

MDES BIOS Status Code

This item allows users to enable or disable MDES BIOS Status Code function.

Firmware Update Configuration

This item allows users to enable or disable ME FW image re-flash function.

3.3.5 AMT Configuration

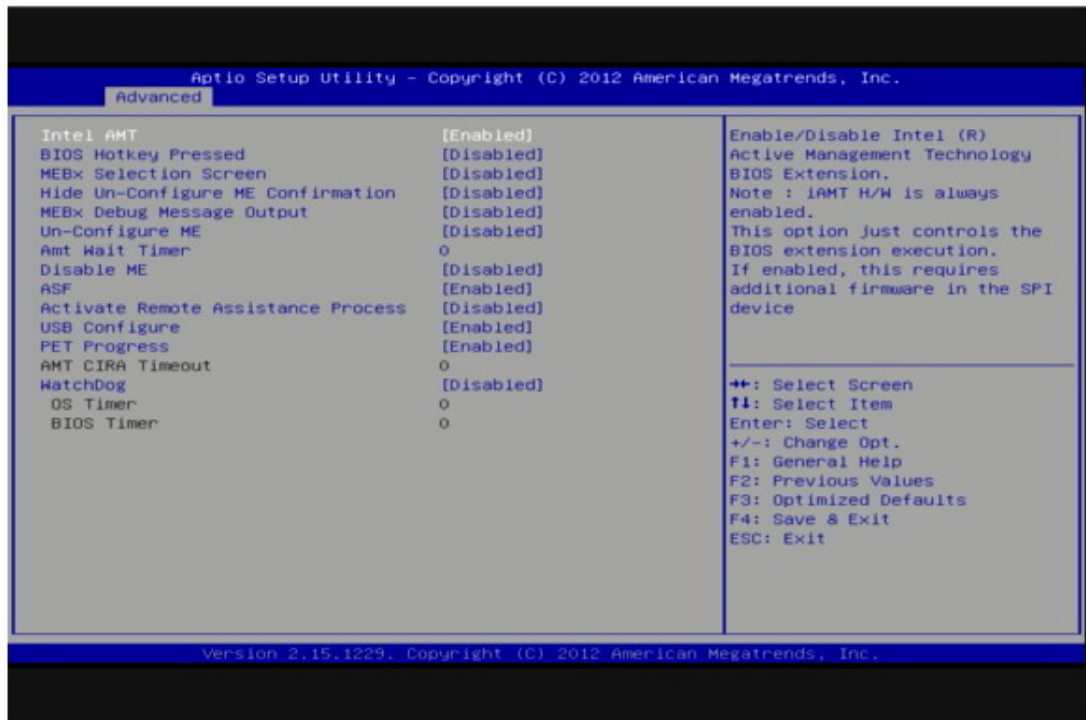

Figure 3.10 AMT Configuration

Intel AMT

This item allows users to enable or disable Intel AMT BIOS extension.

BIOS Hotkey Pressed

This item allows users to enable or disable BIOS hotkey press.

MEBx Selection Screen

This item allows users to enable or disable MEBx selection screen.

Hide Un-Configuration ME Confirmation

This item allows users to hide un-configure ME without password confirmation prompt.

MEBx Debug Message Output

This item allows users to enable or disable MEBx debug message.

Un-Configure ME

This item allows users to un-configure ME without password.

Amt Wait Timer

Set timer to wait before sending ASF_GET_BOOT_OPTIONS.

Disable ME

This item allows users to enable or disable Intel ME.

ASF

This item allows users to enable or disable Alert Specification Format.

Activate Remote Assistance Process

This item allows users to enable or disable trigger CIRA boot.

USB Configure

This item allows users to enable or disable USB configure function.

PET Progress

This item allows users to enable or disable PET events progress to receive PET events or not.

AMT CIRA Timeout

OEM defined timeout for MPS connection to be established.

WatchDog

This item allows users to enable or disable WatchDog Timer.

OS Timer

Set OS watchdog timer.

BIOS Timer

Set BIOS watchdog timer.

3.3.6 USB Configuration

Figure 3.11 USB Configuration

Legacy USB Support

Enable the support for legacy USB. Auto option disables legacy support if no USB devices are connected.

USB3.0 Support

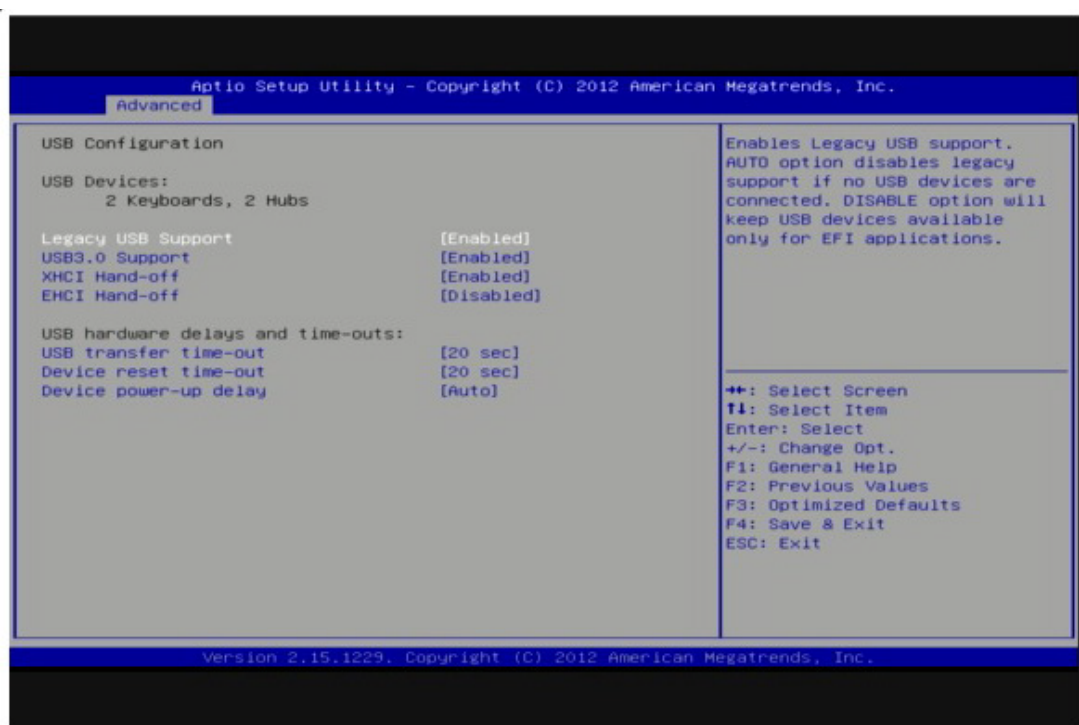
This item allows users to enable or disable USB3.0 support.

XHCI Hand-Off

This is a workaround for the OS without XHCI hand-off support. The XHCI ownership change should claim by XHCI driver.

EHCI Hand-Off

This is a workaround for the OS without EHCI hand-off support. The EHCI ownership change should claim by EHCI driver.

USB transfer time-out

Set the time-out value for Control, Bulk, and Interrupt transfers.

Device reset time-out

Set USB mass storage device Start Unit command time-out value.

Device power-up delay

Set the maximum time of the device will take before it properly reports itself to the Host Controller. 'Auto' uses default value: for a Root port it is 100 ms, for a Hub port the delay is taken from Hub descriptor.

2.0 Flash Disk 5.00

This is a Mass storage device emulation type.

3.3.7 SMART Settings

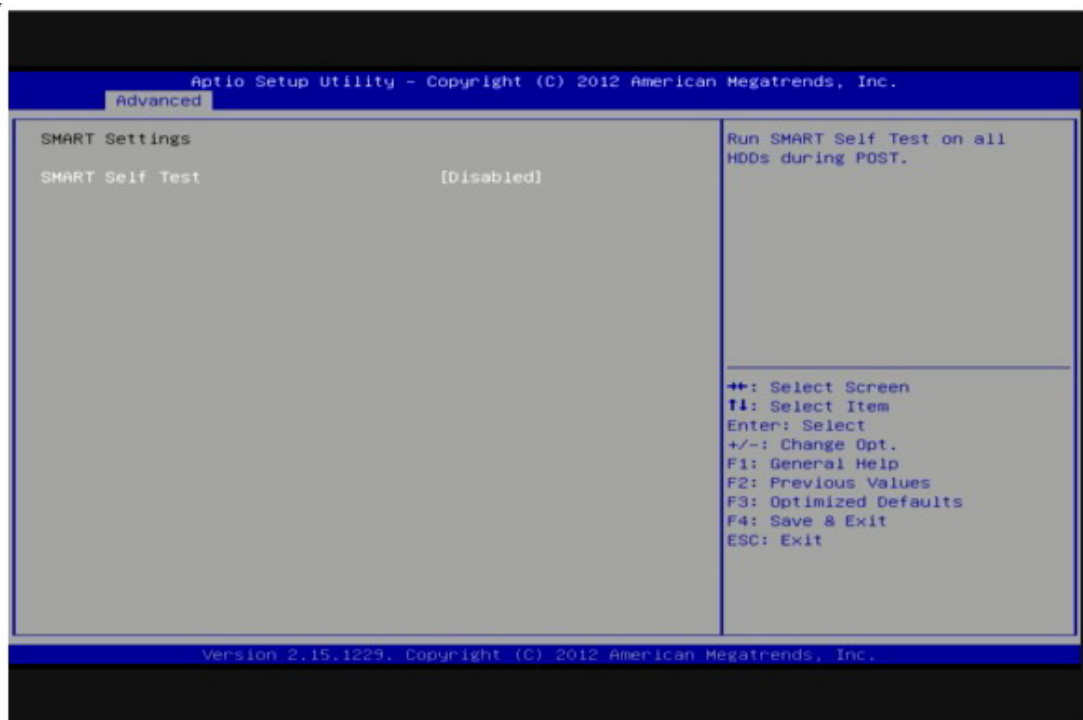

Figure 3.12 SMART Settings

SMART Self Test

This item allows users to enable or disable SMART Self Test.

3.3.8 IT8760 Super IO Configuration

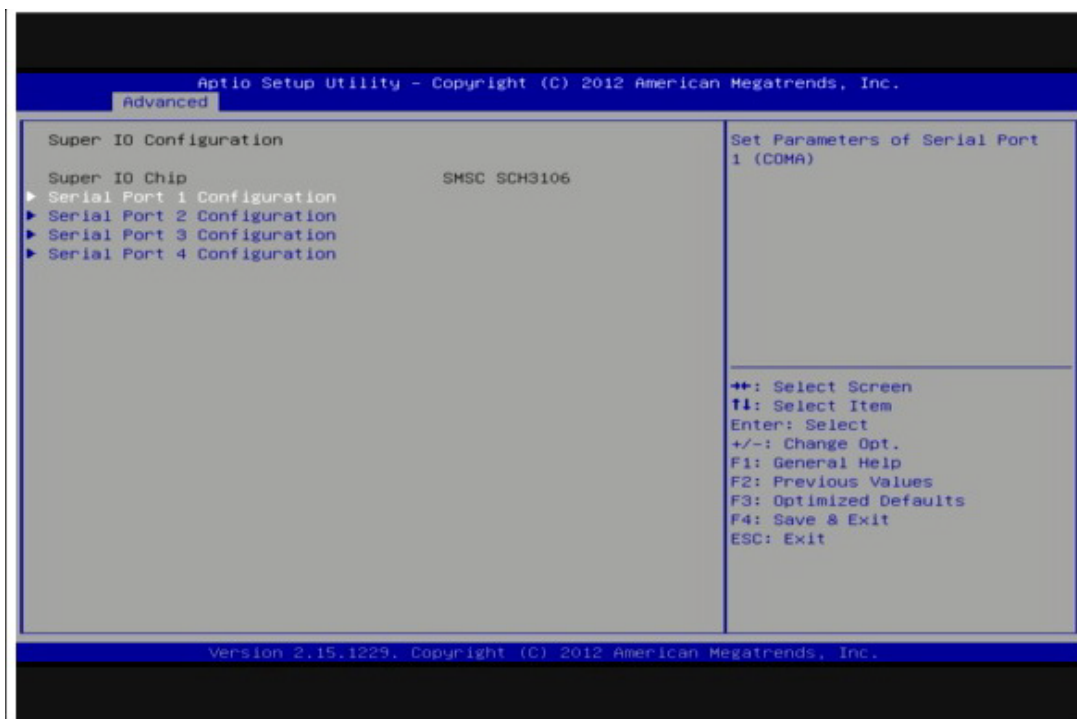

Figure 3.13 Super IO Configuration

3.3.8.1 Serial Port 1 Configuration

Serial Port

This item allows users to enable or disable COM1.

Change Settings

This item allows users to select super I/O device.

3.3.8.2 Serial Port 2 Configuration

Serial Port

This item allows users to enable or disable COM2.

Change Settings

This item allows users to select super I/O device.

3.3.8.3 Serial Port 3 Configuration

Serial Port

This item allows users to enable or disable COM3.

Change Settings

This item allows users to select super I/O device.

Device Mode

This item allows users to select Serial Port mode.

Serial interface

This item allows users to select RS-232/422/485. Default by RS-232.

3.3.8.4 Serial Port 4 Configuration

Serial Port

This item allows users to enable or disable COM4.

Change Settings

This item allows users to select super I/O device

Device Mode

This item allows users to select Serial Port mode.

Serial interface

This item allows users to select RS-232/422/485. Default by RS-232.

3.3.9 Platform Misc Configuration

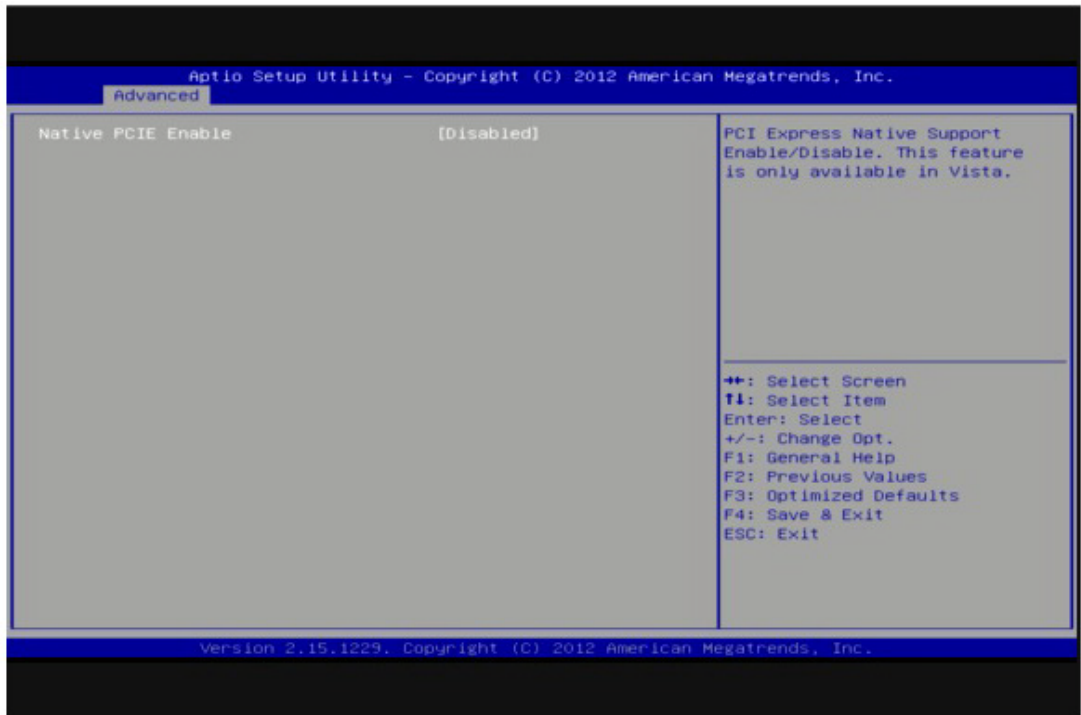

Figure 3.14 Platform Misc Configuration

Native PCIE Enable

This item allows users to enable or disable native PCIE support feature.

3.3.10 Embedded Controller Configuration

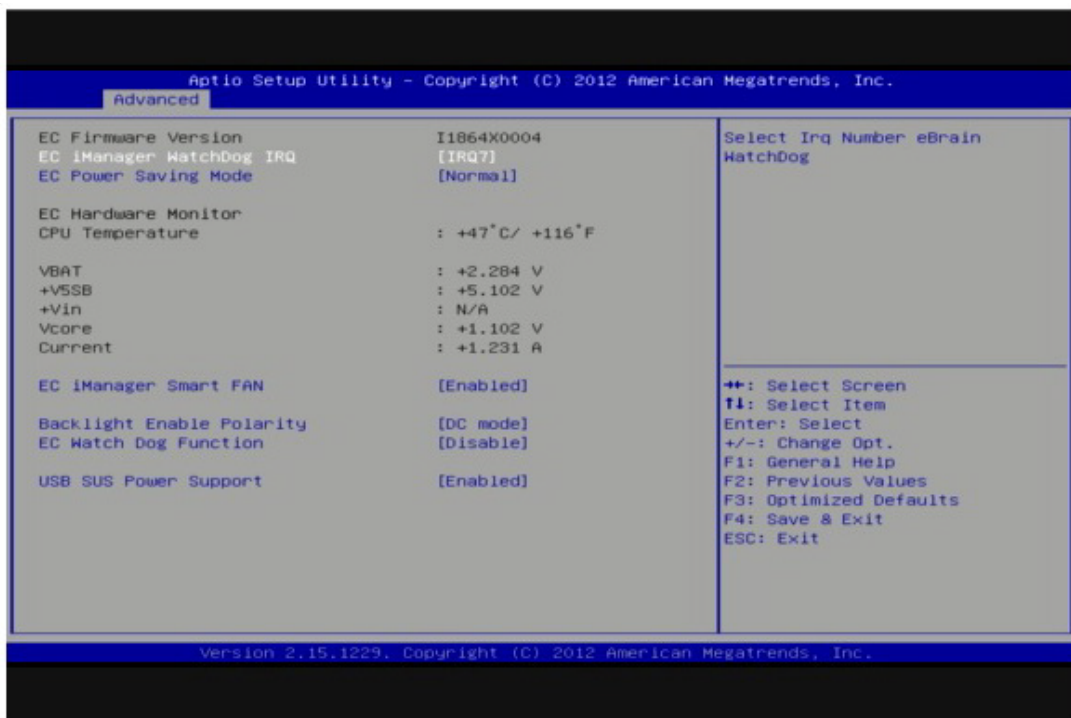

Figure 3.15 Embedded Controller Configuration

Power Saving Mode

This item allows users to select ITE8518 power saving mode.

H/W Monitor

This item is show CPU temperature and VBAT / +5V / +12V / +Vcore voltage information.

Backlight Enable Polarity

This item allows users to set backlight Function.

EC Watch Dog Function

This item allows users to set EC Watch Dog Function.

USB SUS Power Support

This item allows users to set the standby power for USB5, USB6 under SUS mode.

3.3.11 Serial Port Console Redirection

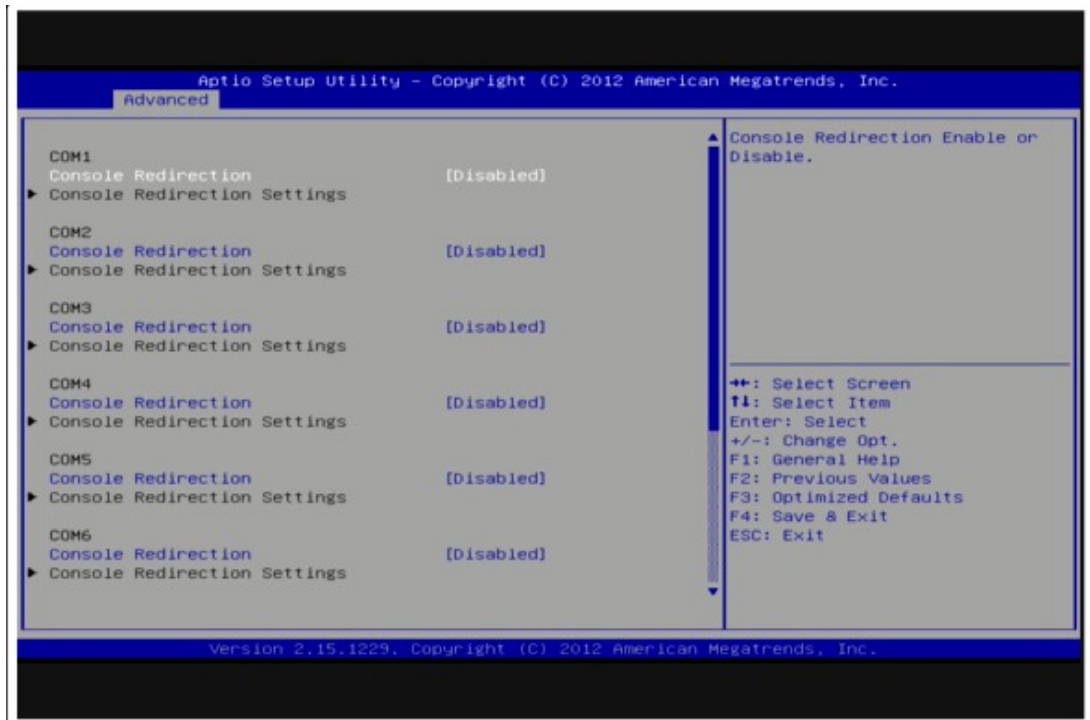

Figure 3.16 Serial Port Console Redirection

Console Redirection

This item allows users to enable or disable console redirection for Microsoft Windows Emergency Management Services (EMS).

Console Redirection Settings

This item allows users to configuration console redirection detail settings.

3.3.12 CPU PPM Configuration

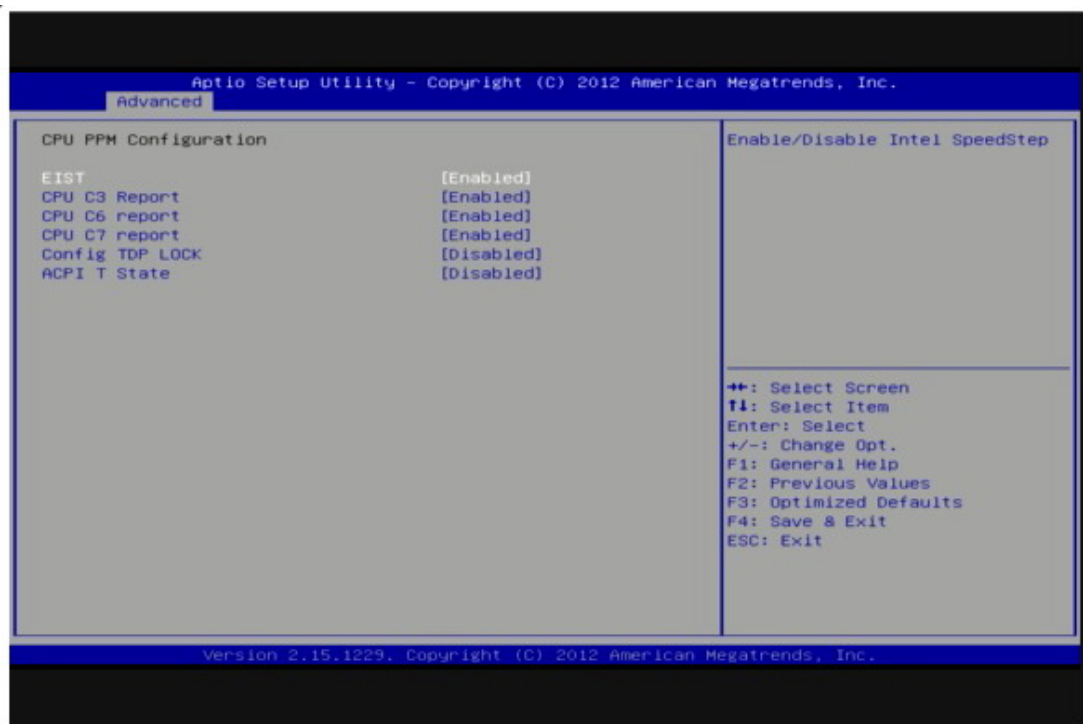

Figure 3.17 CPU PPM Configuration

EIST

CPU runs at its default speed if disabled; CPU speed is controlled by the operating system if enabled.

CPU C3/C6/C7 Report

This item allows users to enable or disable CPU C-state support.

Config TDP LOCK

This item allows users to enable or disable Config TDP LOCK.

ACPI T State

This item allows users to enable or disable ACPI T State.

3.4 Chipset

Select the Chipset tab from the ARK-3510 setup screen to enter the Chipset BIOS Setup screen. You can display a Chipset BIOS Setup option by highlighting it using the <Arrow> keys. All Plug and Play BIOS Setup options are described in this section. The Plug and Play BIOS Setup screen is shown below.

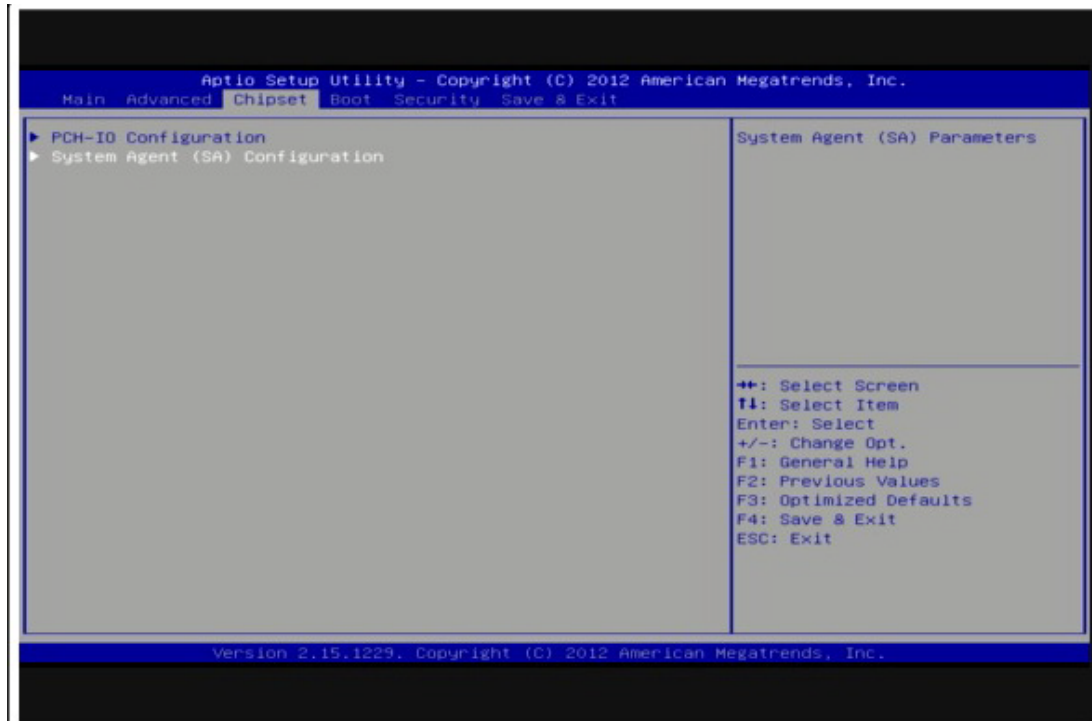

Figure 3.18 Chipset Setup

3.4.1 PCH-IO Configuration

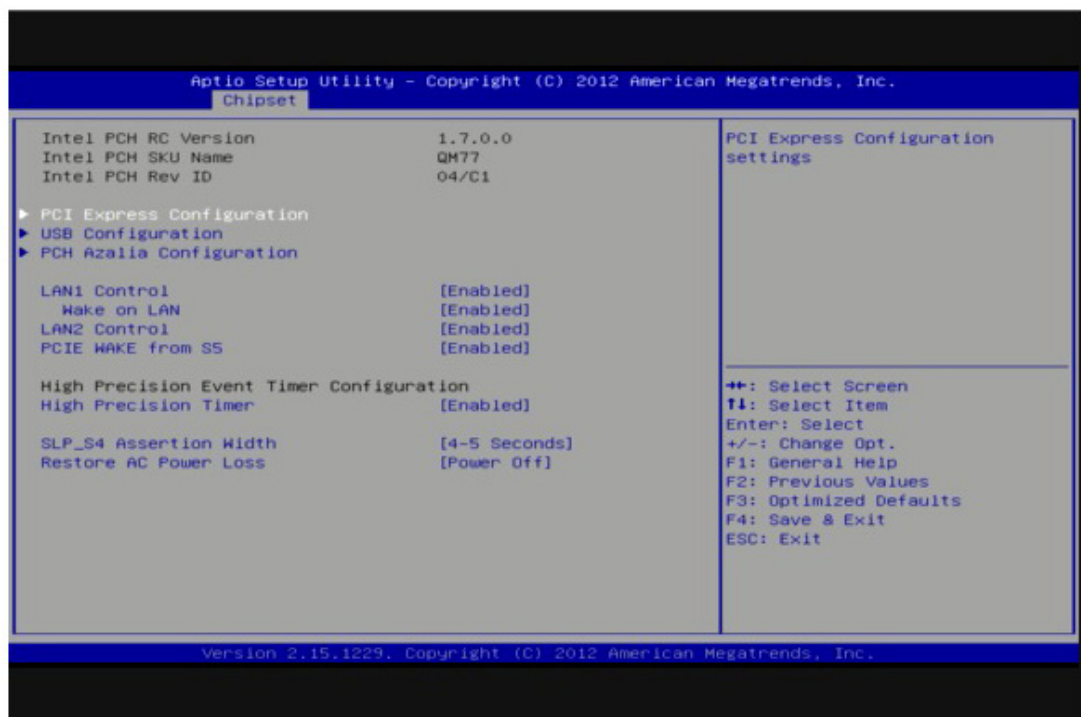

Figure 3.19 PCH-IO Configuration

PCI Express Configuration

This item allows users to configuration PCIE1~PCIE8 root port detail settings.

USB Configuration

This item allows users to configuration detail of USB functions.

PCH Azalia Configuration

This item allows users to configuration detail of azalia functions.

PCH LAN controller

Enables or disables the PCH LAN controller.

PCIe Wake from S5

PCIe wake Enables or disables from S5 state.

High Precision Timer

Enables or disables the high precision timer.

SLP_S4 Assertion Width

This item allows users to set a delay of sorts.

Restore AC Power Loss

This item allows users to select off, on and last state.

3.4.2 System Agent (SA) Configuration

Figure 3.20 System Agent (SA) Configuration

3.4.2.1 Intel IGFX Configuration

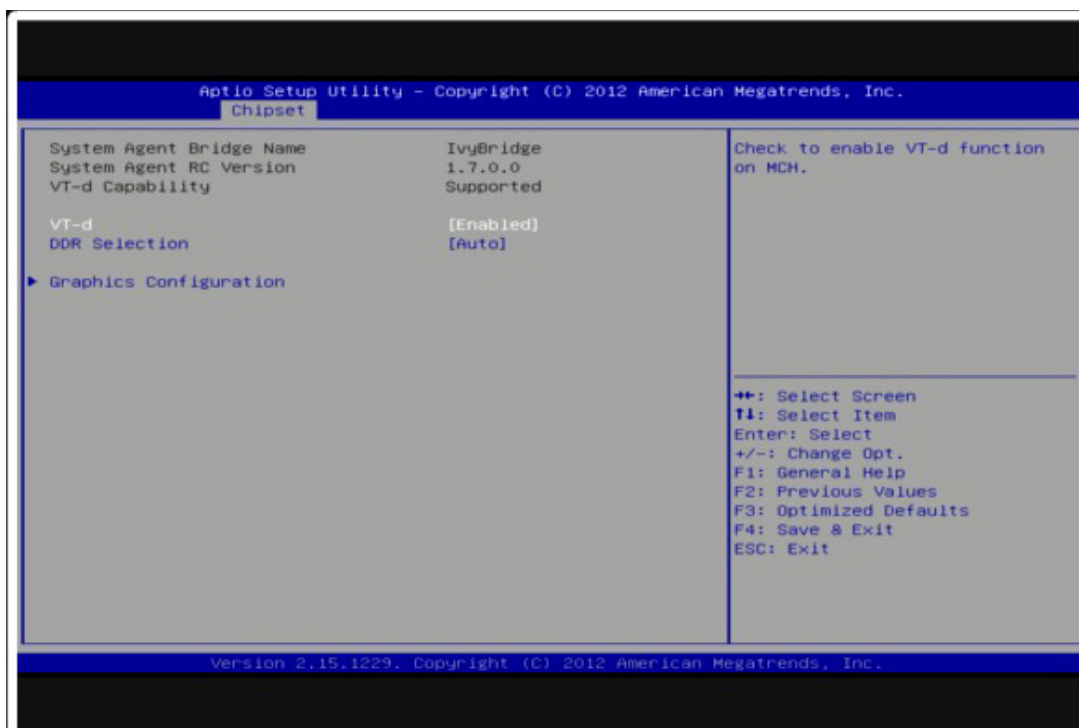
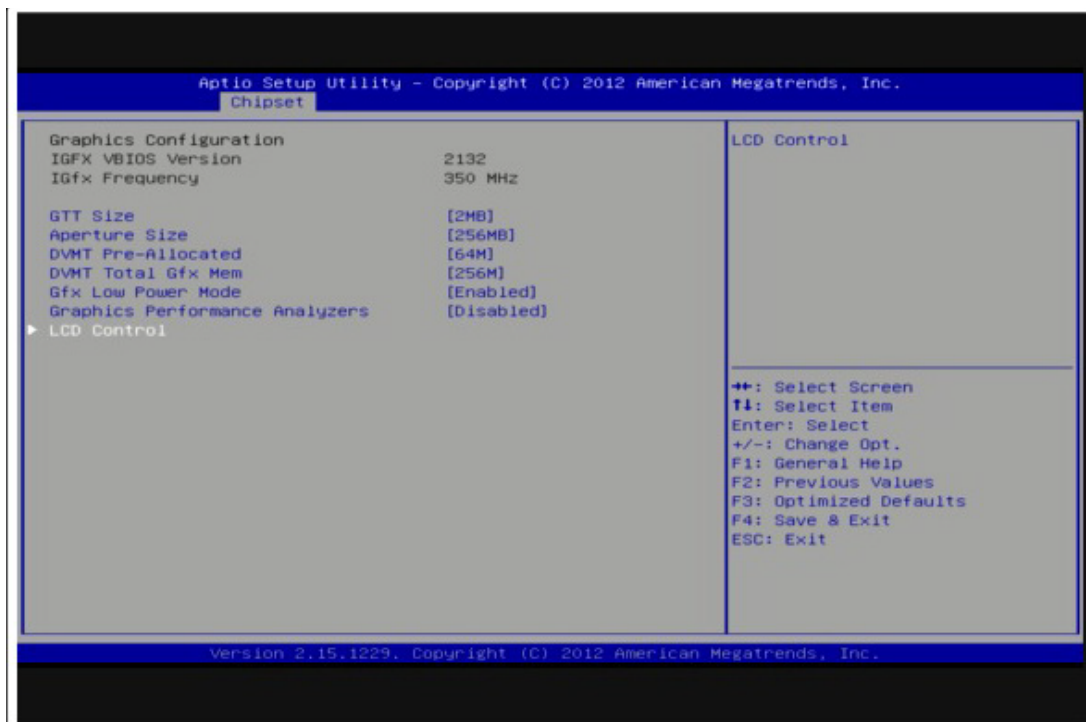

Figure 3.21 Intel IGFX Configuration

GTT Size

This item allows users to select GTT size.

Aperture Size

This item allows users to select aperture size.

DVMT Pre-Allocated

This item allows users to select DVMT pre-allocated memory size.

DVMT Total Gfx Mem

This item allows users to select DVMT total memory size.

Gfx Low Power Mode

This item allows users to enable or disable IGD low power mode.

Graphics Performance Analyzers

This item allows users to enable or disable Graphics Performance Analyzers

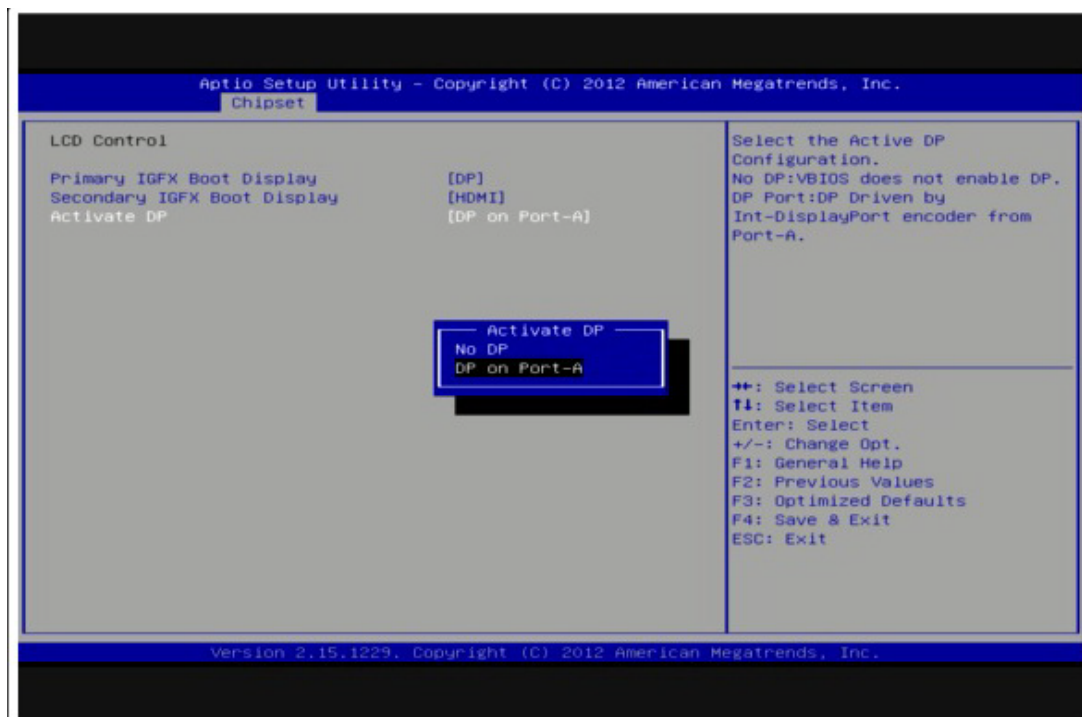
LCD Control**Figure 3.22 LCD Control****Primary IGFX Boot Display**

Select boot display device at post stage.

Secondary IGFX Boot Display

Select boot display device at post stage.

Active DP

Select DP display device at post stage.

3.5 Boot Settings

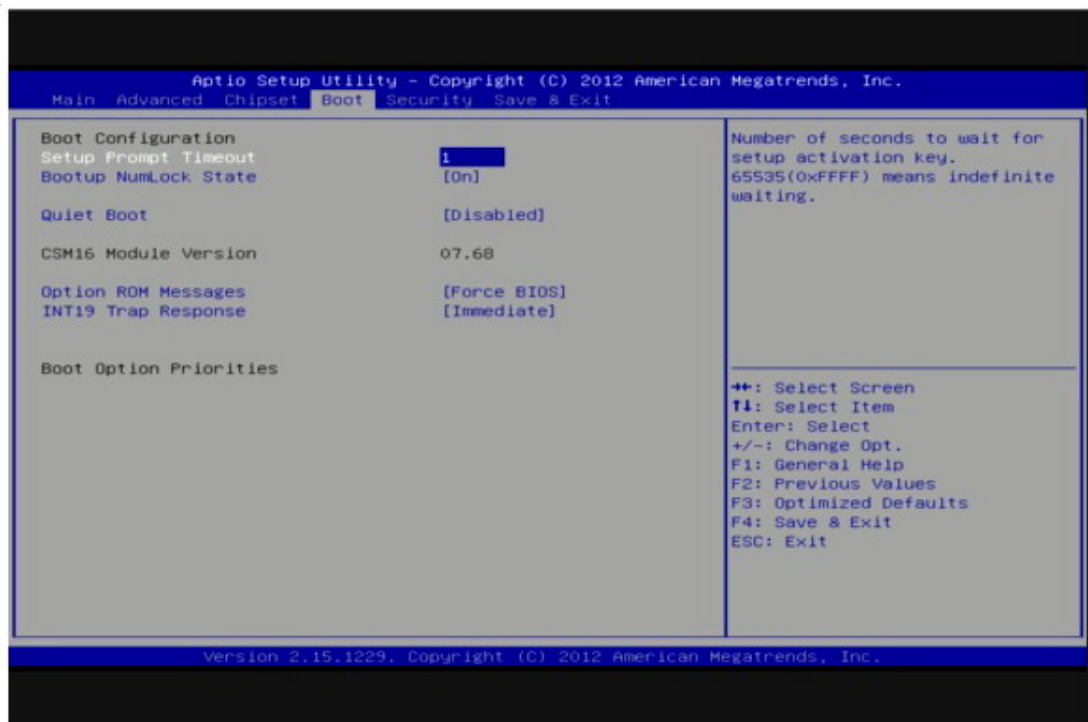

Figure 3.23 Boot Setup Utility

Setup Prompt Timeout

This item allows users to select the number of seconds to wait for setup activation key.

Bootup NumLock State

Select the Power-on state for Numlock.

Quiet Boot

If this option is set to Disabled, the BIOS displays normal POST messages. If Enabled, an OEM Logo is shown instead of POST messages.

Option ROM Message

Set display mode for option ROM.

INT19 Trap Response

This item allows option ROMs to trap interrupt 19.

3.6 Security Setup

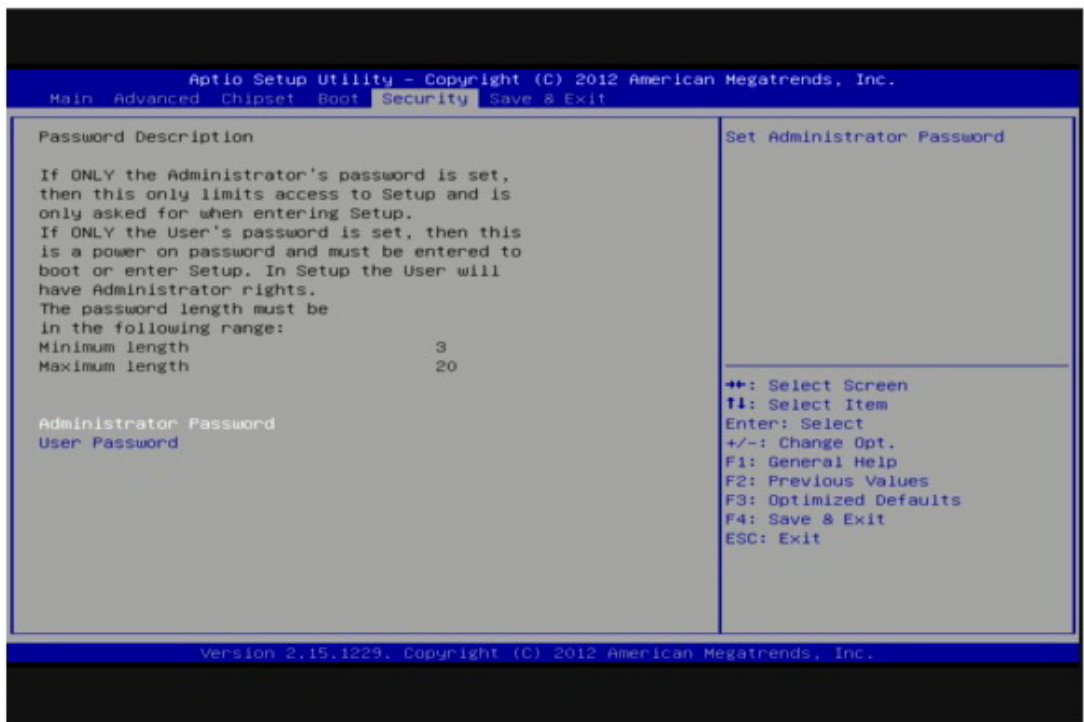

Figure 3.24 Password Configuration

Select Security Setup from the ARK-3510 Setup main BIOS setup menu. All Security Setup options, such as password protection is described in this section. To access the sub menu for the following items, select the item and press <Enter>:

Change Administrator / User Password: Select this option and press <ENTER> to access the sub menu, and then type in the password.

3.7 Save & Exit

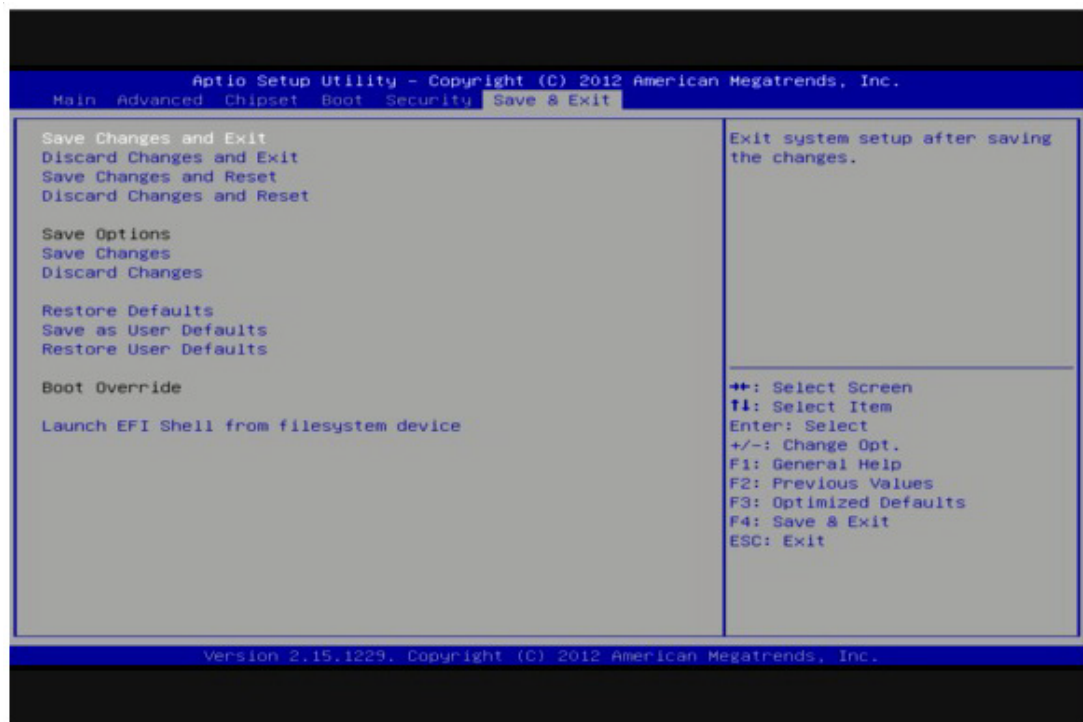

Figure 3.25 Save & Exit

Save Changes and Exit

When users have completed system configuration, select this option to save changes, exit BIOS setup menu and reboot the computer if necessary to take effect all system configuration parameters.

Discard Changes and Exit

Select this option to quit Setup without making any permanent changes to the system configuration.

Save Changes and Reset

When users have completed system configuration, select this option to save changes, exit BIOS setup menu and reboot the computer to take effect all system configuration parameters.

Discard Changes and Reset

Select this option to quit Setup without making any permanent changes to the system configuration and reboot the computer.

Save Changes

When users have completed system configuration, select this option to save changes without exit BIOS setup menu.

Discard Changes

Select this option to discard any current changes and load previous system configuration.

Restore Defaults

The ARK-3510 automatically configures all setup items to optimal settings when users select this option. Optimal Defaults are designed for maximum system performance, but may not work best for all computer applications. In particular, do not use the Optimal Defaults if the user's computer is experiencing system configuration problems.

Save User Defaults

When users have completed system configuration, select this option to save changes as user defaults without exit BIOS setup menu.

Restore User Defaults

The users can select this option to restore user defaults.

Appendix **A**

Watchdog Timer
Sample Code

A.1 EC Watchdog Timer sample code

```
EC_Command_Port = 0x29Ah
EC_Data_Port = 0x299h
Write EC HW ram = 0x89
Watch dog event flag = 0x57
Watchdog reset delay time = 0x5E
Reset event = 0x04
Start WDT function = 0x28
=====
.model small
.486p
.stack 256
.data
.code
org 100h
.STARTup

mov dx, EC_Command_Port
mov al,89h      ; Write EC HW ram.
out dx,al

mov dx, EC_Command_Port
mov al, 5Fh     ; Watchdog reset delay time low byte (5Eh is high byte) index.
out dx,al

mov dx, EC_Data_Port
mov al, 30h     ;Set 3 seconds delay time.
out dx,al

mov dx, EC_Command_Port
mov al,89h     ; Write EC HW ram.
out dx,al

mov dx, EC_Command_Port
mov al, 57h    ; Watch dog event flag.
out dx,al

mov dx, EC_Data_Port
mov al, 04h    ; Reset event.
out dx,al

mov dx, EC_Command_Port
mov al,28h    ; start WDT function.
out dx,al

.exit
END
```

ADVANTECH

Enabling an Intelligent Planet

www.advantech.com

Please verify specifications before quoting. This guide is intended for reference purposes only.

All product specifications are subject to change without notice.

No part of this publication may be reproduced in any form or by any means, electronic, photocopying, recording or otherwise, without prior written permission of the publisher.

All brand and product names are trademarks or registered trademarks of their respective companies.

© Advantech Co., Ltd. 2013