

## Power cable - SAC-5P-M12MRL/ 3,0-280 FE - 1414854

Please be informed that the data shown in this PDF Document is generated from our Online Catalog. Please find the complete data in the user's documentation. Our General Terms of Use for Downloads are valid (<http://phoenixcontact.com/download>)



Power cable, 5-position, PUR halogen-free, gray RAL 7001, Plug angled M12, L-coded, on free cable end, cable length: 3 m, for direct current up to 16 A/63 V

### Your advantages

- ✓ Easy and safe: 100% electrically tested plug-in components
- ✓ High-performance: DC connectors for up to 16 A and 63 V DC
- ✓ Protection against mismatching, thanks to special L-coding
- ✓ Our standard: robust halogen-free PUR cable

### Key Commercial Data

Packing unit	1 pc
GTIN	
GTIN	4055626034867

### Technical data

#### Dimensions

Length of cable	3 m
-----------------	-----

#### Ambient conditions

Ambient temperature (operation)	-25 °C ... 85 °C (Plug / socket)
Degree of protection	IP65/IP67

#### General

Rated current at 40°C	16 A
Rated voltage	63 V DC
Number of positions	5
Color handle area	black
Insulation resistance	≥ 100 MΩ
Coding	L - Power

# Power cable - SAC-5P-M12MRL/ 3,0-280 FE - 1414854

## Technical data

### General

Standards/regulations	M12 connector IEC 61076-2-111
Status display	No
Protective circuit/component	unwired
Overvoltage category	III
Degree of pollution	3
Torque	0.4 Nm (M12 connector)

### Material

Flammability rating according to UL 94	V0
Contact material	CuZn
Contact surface material	Ni/Au
Contact carrier material	PA
Material of grip body	PP
Material, knurls	Zinc die-cast, nickel-plated

### Standards and Regulations

Standard designation	M12 connector
Standards/regulations	IEC 61076-2-111
Flammability rating according to UL 94	V0

### Cable

Cable type	PUR halogen-free gray
Cable type (abbreviation)	280
UL AWM style	20233 / 10493 (80°C/300 V)
Conductor cross section	5x 2.5 mm <sup>2</sup>
AWG power supply	14
Conductor structure, voltage supply	141x 0.15 mm
Core diameter including insulation	2.85 mm ±0.1 mm
Thickness, insulation	≥ 0.31 mm
Wire colors	Brown, white, blue, black, gray
External sheath, color	gray RAL 7001
Outer sheath thickness	approx. 0.76 mm
External cable diameter D	9.65 mm ±0.25 mm
Minimum bending radius, fixed installation	5 x D
Minimum bending radius, flexible installation	10 x D
Number of bending cycles	4000000
Minimum bending radius, drag chain applications	10 x D
Traversing path	10 m
Traversing rate	3 m/s
Acceleration	10 m/s <sup>2</sup>
Cable weight	185 kg/km
Outer sheath, material	PUR

## Power cable - SAC-5P-M12MRL/ 3,0-280 FE - 1414854

### Technical data

#### Cable

Material conductor insulation	PP
Conductor material	Bare Cu litz wires
Insulation resistance	$\geq 1 \text{ G}\Omega \cdot \text{km}$ (at 20 °C)
Conductor resistance	$\leq 8 \text{ }\Omega/\text{km}$ (at 20 °C)
Nominal voltage, cable	$\leq 300 \text{ V AC}$
Test voltage, cable	$\geq 3000 \text{ V AC}$ (Spark test)
Flame resistance	According to UL 758/1581 (Cable Flame)
	according to UL 758/1581 FT1
	According to DIN EN 60332-1-2
Halogen-free	in accordance with DIN VDE 0472 part 815
	in accordance with DIN EN 50267-2-1
Resistance to oil	according to DIN EN 60811-404, 168 h at 100 °C
Other resistance	Hydrolysis and microbe resistant as per VDE 0282 section 10
	Low adhesion
	abrasion-resistant
	Resistant to salt water
Ambient temperature (operation)	-50 °C ... 80 °C (cable, fixed installation)
	-30 °C ... 80 °C (cable, flexible installation)

#### Environmental Product Compliance

REACH SVHC	Lead 7439-92-1
China RoHS	Environmentally Friendly Use Period = 50
	For details about hazardous substances go to tab "Downloads", Category "Manufacturer's declaration"

#### Drawings

# Power cable - SAC-5P-M12MRL/ 3,0-280 FE - 1414854

Dimensional drawing

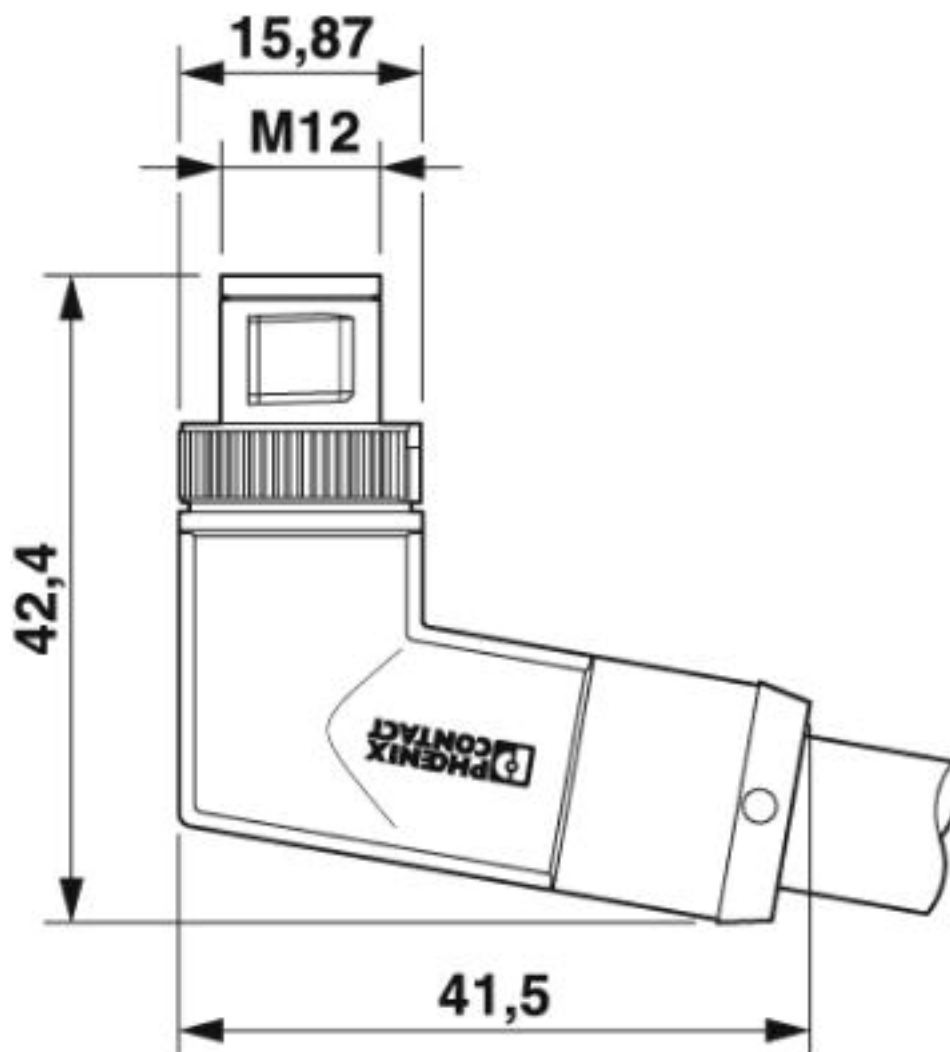

M12 x 1 male plug, angled

## Power cable - SAC-5P-M12MRL/ 3,0-280 FE - 1414854

Schematic diagram

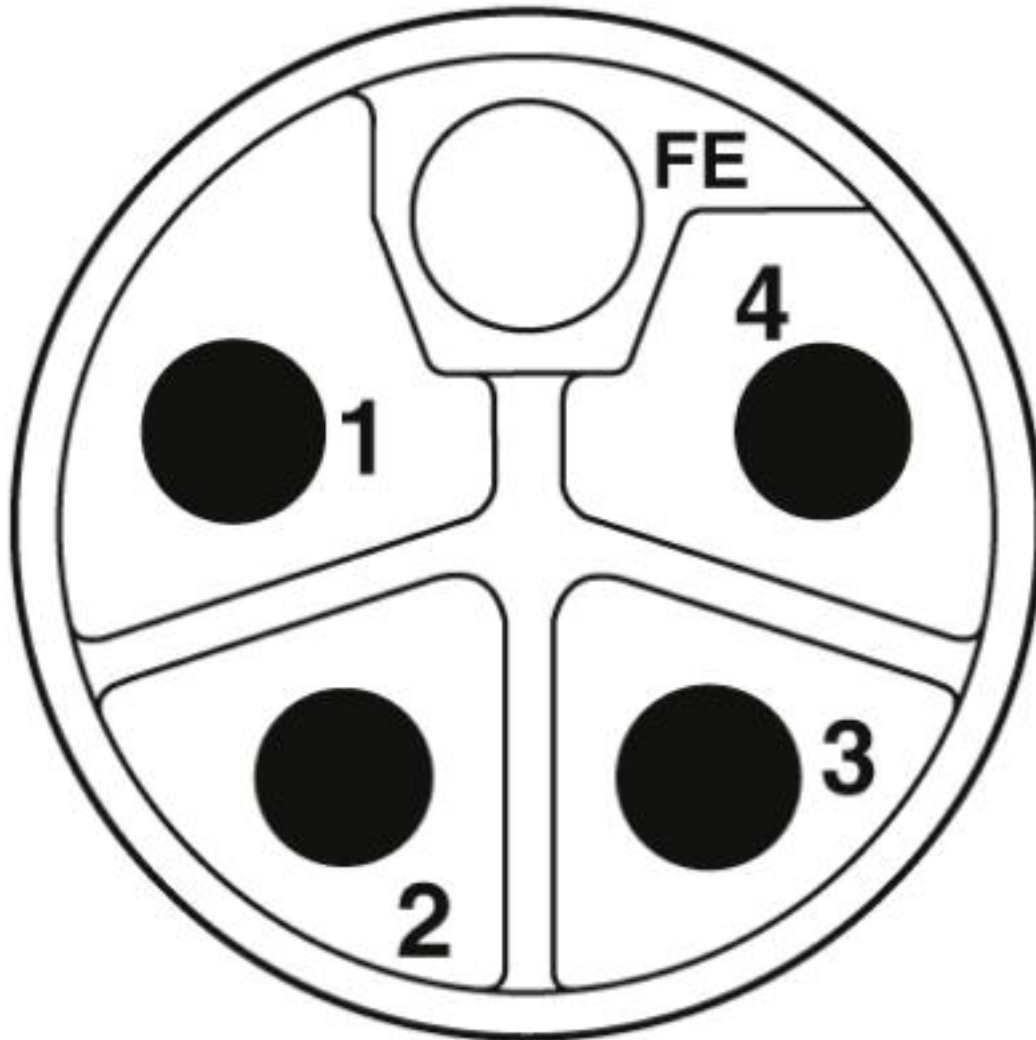

Pin assignment of M12 connector, 5-pos., L-coded, pin side view

# Power cable - SAC-5P-M12MRL/ 3,0-280 FE - 1414854

Diagram

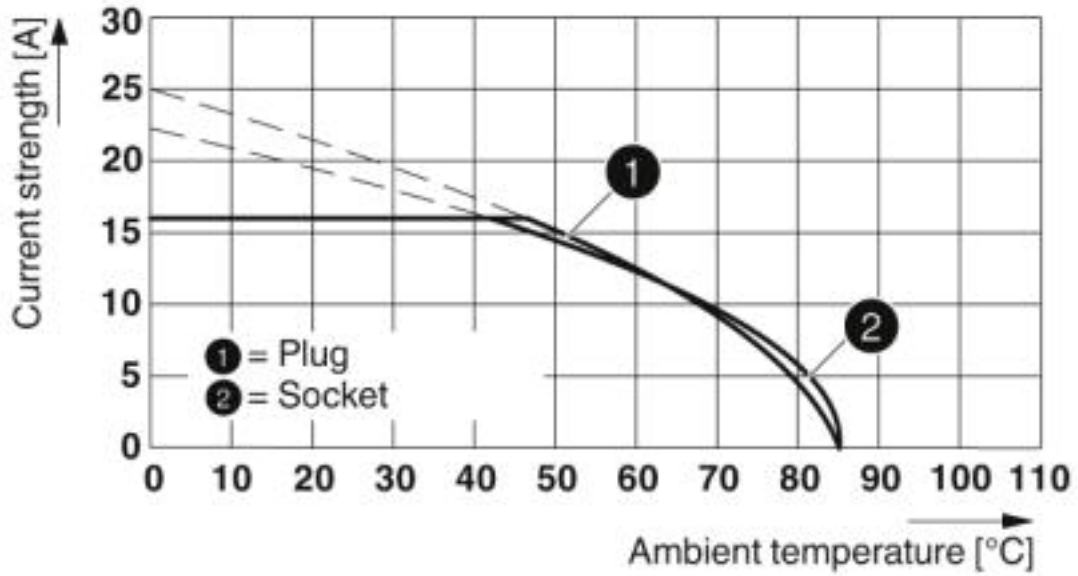

Circuit diagram

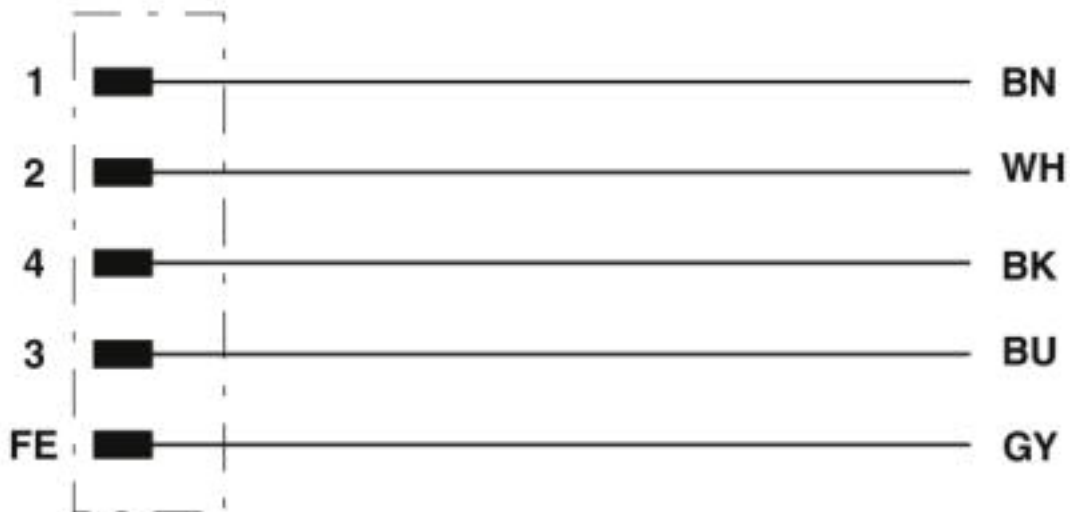

Contact assignment of the M12 plug

# Power cable - SAC-5P-M12MRL/ 3,0-280 FE - 1414854

Cable cross section

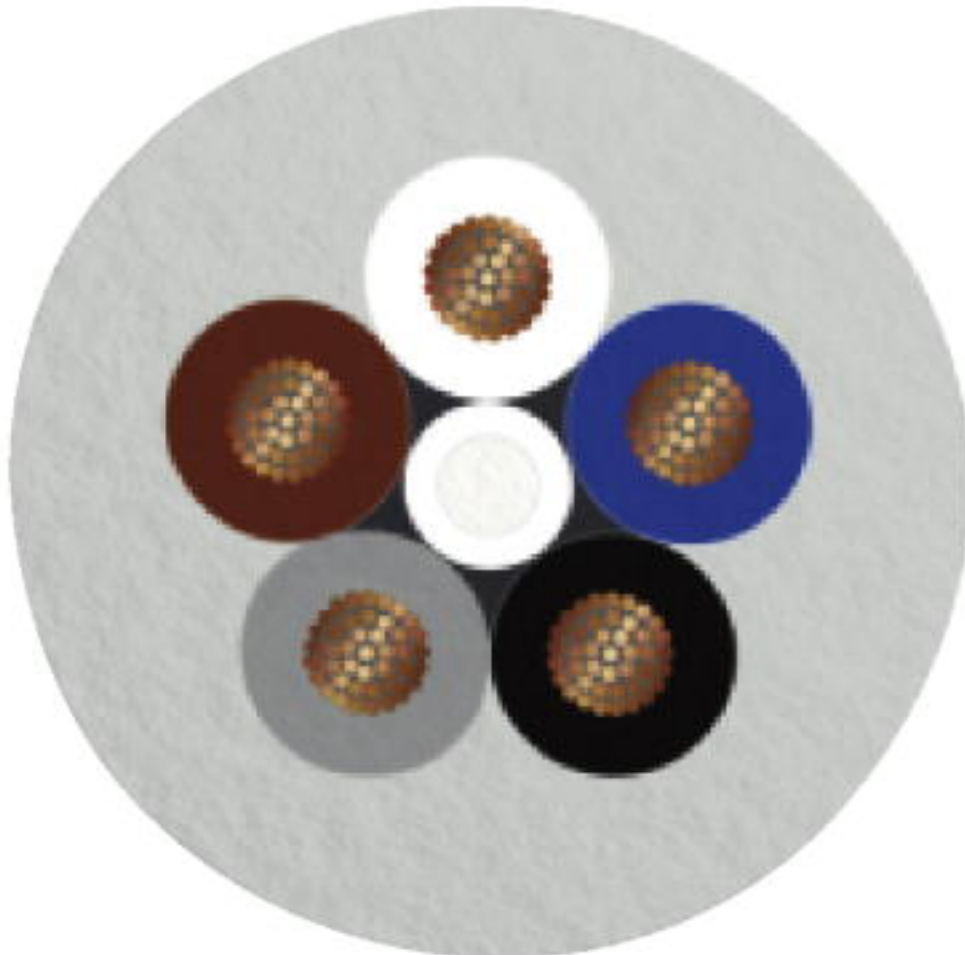

PUR halogen-free gray [280]

## Approvals

Approvals

---

Approvals

UL Listed / cUL Listed / EAC / cULus Listed

---

Ex Approvals

---

Approval details

# Power cable - SAC-5P-M12MRL/ 3,0-280 FE - 1414854

## Approvals

UL Listed		<a href="http://database.ul.com/cgi-bin/XYV/template/LISEXT/1FRAME/index.htm">http://database.ul.com/cgi-bin/XYV/template/LISEXT/1FRAME/index.htm</a>	E468743
Nominal voltage UN		63 V	
Nominal current IN		16 A	
mm <sup>2</sup> /AWG/kcmil		14	

cUL Listed		<a href="http://database.ul.com/cgi-bin/XYV/template/LISEXT/1FRAME/index.htm">http://database.ul.com/cgi-bin/XYV/template/LISEXT/1FRAME/index.htm</a>	E468743
Nominal voltage UN		63 V	
Nominal current IN		16 A	
mm <sup>2</sup> /AWG/kcmil		14	

EAC		RU C- DE.BL08.B.00286
-----	---	--------------------------

cULus Listed	
--------------	---

Phoenix Contact 2019 © - all rights reserved  
<http://www.phoenixcontact.com>

PHOENIX CONTACT GmbH & Co. KG  
 Flachsmarktstr. 8  
 32825 Blomberg  
 Germany  
 Tel. +49 5235 300  
 Fax +49 5235 3 41200  
<http://www.phoenixcontact.com>