

AAT4616A: High Precision Adjustable Current Limited Load Switch with Fault Flag

Applications

- USB ports
- Portable products
- Hot-swap supplies
- Notebook computers
- Proprietary peripheral ports

Features

- Input voltage: 2.4 V to 5.5 V
- Programmable over-current limit setting: 300 mA to 1.6 A
- $\pm 10\%$ current limit precision at 750 mA
- Fast transient response: 2 μs response to short circuit
- Low quiescent current
 - 10 μA typical while enabled
 - 1 μA maximum with switch off
- 130 m Ω typical $R_{DS(ON)}$
- Under-Voltage Lockout (UVLO)
- Reverse blocking during disable
- 4 ms fault blanking
- Fault flag open-drain output
- Active high/low enable options
- Over-temperature protection
- Temperature range: $-40\text{ }^{\circ}\text{C}$ to $+85\text{ }^{\circ}\text{C}$
- TDFN (6-pin, 2 x 2 mm) package (MSL1, 260 $^{\circ}\text{C}$ per JEDEC-J-STD-020)

Description

The AAT4616A SmartSwitch is a current-limiting P-channel MOSFET power switch designed for high side load switching applications. This switch operates with inputs ranging from 2.4 V to 5.5 V, making it ideal for both 3 V and 5 V systems. An integrated current-limiting circuit protects the input supply against large currents that may cause the supply to fall out of regulation. Reverse current blocking is provided to protect the load switch from reverse current potentials while the device is shutdown.

The AAT4616A is also protected from thermal overload which is limited by power dissipation and junction temperatures. The current limit threshold is programmed with a resistor from SET to ground and may be adjusted for levels up to 1.6 A. The ultra-fast current limit response to a sudden short circuit is a mere 2 μs , which reduces the requirements of local supply bypassing. An open drain FAULT flag signals an over-current or over-temperature condition after a 4 ms blanking time to prevent false reporting. Quiescent current is as low as 10 μA and the supply current decreases to less than 1 μA in shutdown mode.

The AAT4616A is offered in a small Thin, Dual Flat No-Lead (TDFN22-6) package. A typical application circuit is shown in Figure 1. The pin configuration is shown in Figure 2. Signal pin assignments and functional pin descriptions are provided in Table 1.



Skyworks Green™ products are compliant with all applicable legislation and are halogen-free. For additional information, refer to *Skyworks Definition of Green™*, document number SQ04-0074.

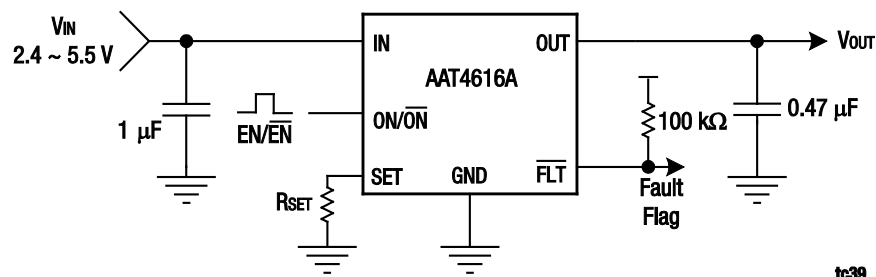

Figure 1. AAT4616A Typical Application Circuit

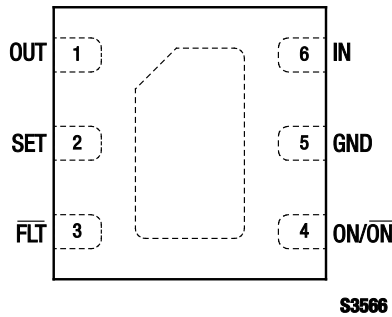

Figure 2. AAT4616A TDFN22-6 (Top View)

Table 1. AAT4616A Signal Descriptions

| Pin # | Name | Description |
|-------|-------|--|
| 1 | OUT | Current limiting load switch output (high side P-channel MOSFET drain). Connect a 0.47 μ F capacitor from OUT to GND for best load transient response. |
| 2 | SET | Current limit set pin. Connect a resistor between this pin and ground to program the desired current limit set point. |
| 3 | FLT | Current limit fault flag pin, open-drain output, active low signal. Pull up with a 10 k Ω to 100 k Ω resistor. |
| 4 | ON/ON | Load switch enable input. Active high and active low options are available. |
| 5 | GND | Ground |
| 6 | IN | Load switch power supply input pin (high side P-channel MOSFET source). Bypass with a 1 μ F capacitor from IN to GND. |

Table 2. AAT4616A Absolute Maximum Ratings (Note 1)

| Parameter | Symbol | Minimum | Typical | Maximum | Units |
|--|-------------------------------------|---------|---------|-----------------------|-------|
| IN to GND | V _{IN} | -0.3 | | +6.0 | V |
| ON/ON, FLT to GND | V _{ON} , V _{FLT} | -0.3 | | V _{IN} + 0.3 | V |
| SET, OUT to GND | V _{SET} , V _{OUT} | -0.3 | | V _{IN} + 0.3 | V |
| Maximum DC output current (Note 2) | I _{MAX} | | | 2 | A |
| Operating junction temperature range | T _J | -40 | | +150 | °C |
| Storage temperature range | T _{STG} | -40 | | +150 | °C |
| Maximum Soldering Temperature (at leads) | T _{LEAD} | | | 300 | °C |
| Thermal resistance | θ _{JA} | | 85 | | °C/W |
| Power dissipation (Note 3) | P _D | | 1.18 | | W |

Note 1: Exposure to maximum rating conditions for extended periods may reduce device reliability. There is no damage to device with only one parameter set at the limit and all other parameters set at or below their nominal value. Exceeding any of the limits listed may result in permanent damage to the device.

Note 2: The current rating is based on long-term current density limitations.

Note 3: Mounted on an FR4 board. Derated 11.8 mW/°C above 25 °C.

CAUTION: Although this device is designed to be as robust as possible, Electrostatic Discharge (ESD) can damage this device. This device must be protected at all times from ESD. Static charges may easily produce potentials of several kilovolts on the human body or equipment, which can discharge without detection. Industry-standard ESD precautions should be used at all times.

Electrical and Mechanical Specifications

The absolute maximum ratings of the AAT4616A are provided in Table 2. The recommended operating conditions are specified in Table 3, and electrical specifications are provided in Table 4.

Typical performance characteristics of the AAT4616A are illustrated in Figures 3 through 14.

Table 3. Recommended Operating Conditions

| Parameter | Symbol | Minimum | Typical | Maximum | Units |
|--------------------------|--------------------|---------|---------|---------|-------|
| Input voltage | V _{IN} | 2.4 | | 5.5 | V |
| High-level Input voltage | V _{ON(H)} | 1.4 | | | V |
| Low-level Input voltage | V _{ON(L)} | | | 0.5 | V |
| Operating temperature | T _A | -40 | | +85 | °C |

Table 4. AAT4616A Electrical Specifications (Note 1)
(V_{IN} = 5 V, T_A = -40 °C to +85 °C [Typical Values are at T_A = 25 °C], Unless Otherwise Noted)

| Parameter | Symbol | Test Condition | Min | Typical | Max | Units |
|--|------------------------|---|------|---------|------|--------|
| Input voltage | V _{IN} | | 2.4 | | 5.5 | V |
| Operating quiescent current | I _Q | V _{IN} = 5 V, ON/ $\overline{\text{ON}}$ = Active, I _{OUT} = 0 A | | 10 | 25 | μA |
| Off supply current | I _{Q(OFF)} | $\overline{\text{ON}}/\overline{\text{ON}}$ = Inactive, V _{IN} = 5.5 V | | 0.01 | 1 | μA |
| Off switch current | I _{SD(OFF)} | $\overline{\text{ON}}/\overline{\text{ON}}$ = Inactive, V _{IN} = 5.5 V, V _{OUT} = 0 V | | 0.01 | 1 | μA |
| Under-Voltage Lockout | V _{UVLO} | Rising edge, 1% Hysteresis | | 1.8 | 2.4 | V |
| UVLO hysteresis | V _{UVLO_HYS} | | | 10 | | mV |
| On resistance | R _{DS(ON)} | V _{IN} = 5.0 V, T _A = 25 °C | | 130 | 180 | mΩ |
| | | V _{IN} = 3.0 V, T _A = 25 °C | | 150 | 230 | |
| On-resistance temperature coefficient | T _{CRDS} | | | 2800 | | ppm/°C |
| Current limit | I _{LIM} | R _{SET} = 35 kΩ, V _{OUT} = V _{IN} - 0.5 V | 0.67 | 0.75 | 0.83 | A |
| Minimum current limit | I _{LIM(MIN)} | | | 300 | | mA |
| $\overline{\text{ON}}/\overline{\text{ON}}$ input low voltage | V _{ON(L)} | V _{IN} = 2.4 V to 5.5 V | | | 0.5 | V |
| $\overline{\text{ON}}/\overline{\text{ON}}$ input high voltage | V _{ON(H)} | V _{IN} = 2.4 V to 5.5 V | 1.4 | | | V |
| $\overline{\text{ON}}/\overline{\text{ON}}$ input leakage | I _{ON(SINK)} | V _{ON} = 5.5 V | | 0.01 | 1 | μA |
| Current limit response time | t _{RESP} | V _{IN} = 5 V | | 2 | | μs |
| Turn-on time | t _{ON} | V _{IN} = 5 V, R _{LOAD} = 10 Ω | | 4 | 7 | μs |
| Turn-off time | t _{OFF} | V _{IN} = 5 V, R _{LOAD} = 10 Ω | 8 | 10 | | μs |
| Fault flag blanking time | t _{BLANK} | | | 4 | | ms |
| Fault flag logic low output | V _{FLT(L)} | I _{FLT(SINK)} = 1 mA | | | 0.4 | V |
| Fault flag logic high leakage current | I _{FLT(SINK)} | | | 0.03 | 1 | μA |
| Over-temperature shutdown threshold | T _{SD} | V _{IN} = 5 V | | 140 | | °C |
| Over-temperature shutdown hysteresis | T _{SD_HYS} | | | 15 | | °C |

Note 1: Performance is guaranteed only under the conditions listed in this Table.

Typical Performance Characteristics

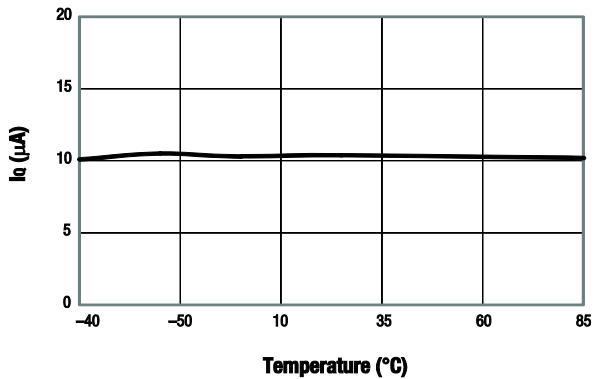

Figure 3. Quiescent Current vs Temperature
(V_{IN} = 5.0 V)

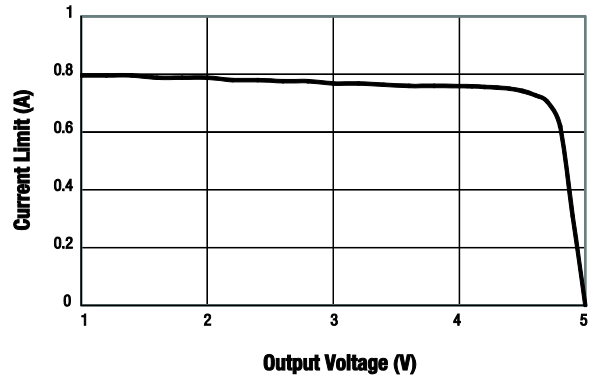

Figure 4. Current Limit vs Output Voltage
(V_{IN} = 5.0 V, T_A = 25 °C, R_{SET} = 34.8 kΩ)

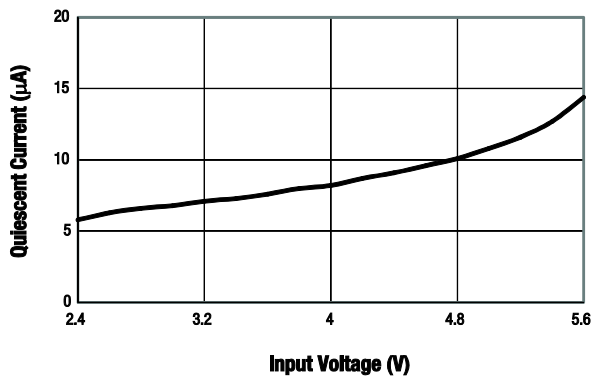

Figure 5. Quiescent Current vs Input Voltage
(T_A = 25 °C)

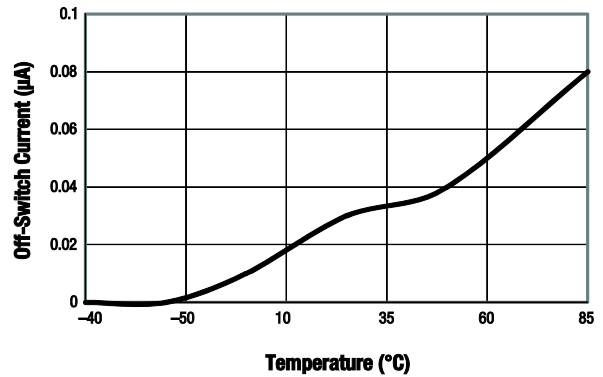

Figure 6. Off-Switch Current vs Temperature
(V_{IN} = 5.0 V)

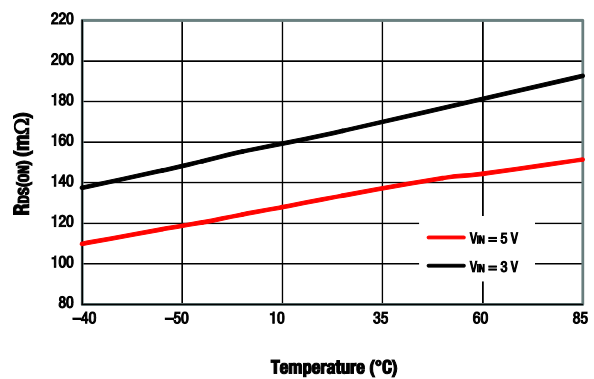

Figure 7. R_{ds(on)} vs Temperature

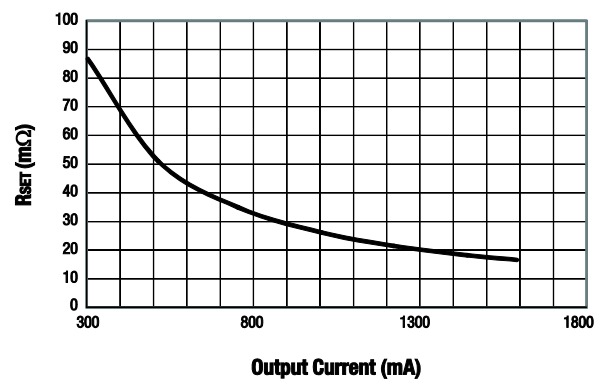

Figure 8. R_{SET} vs I_{LM} (T_A = 25 °C)

Typical Performance Characteristics

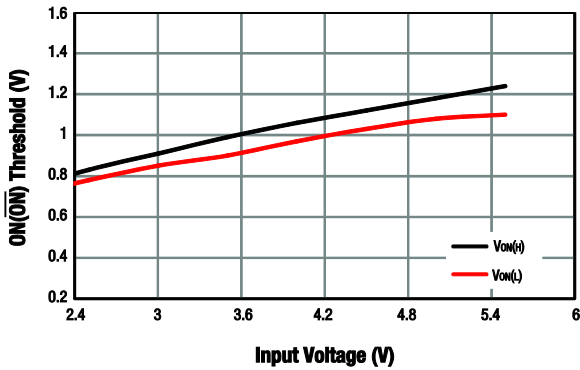

Figure 9. ON(OV) Threshold vs Input Voltage

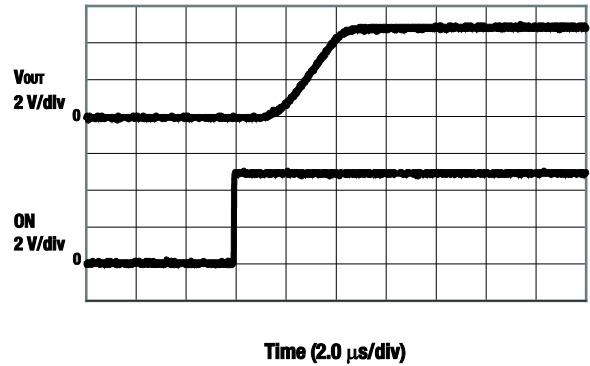

Figure 10. AAT4616AIPU-1 Turn-On
($R_L = 10 \Omega$, $C_L = 0.47 \mu F$)

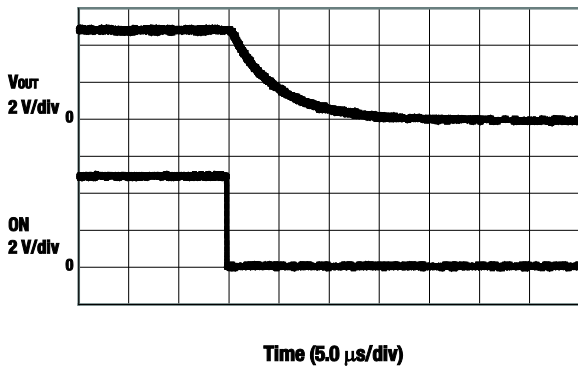

Figure 11. Figure 10. AAT4616AIPU-1 Turn-Off
($R_L = 10 \Omega$, $C_L = 0.47 \mu F$)

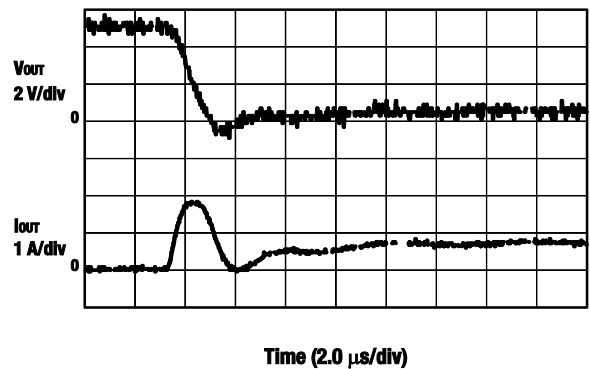

Figure 12. Short Circuit Through 0.3Ω
($V_{IN} = 5.0 V$)

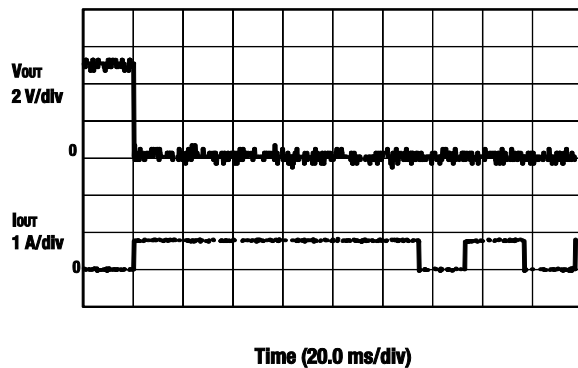

Figure 13. Output Short Response
($V_{IN} = 5.0 V$)

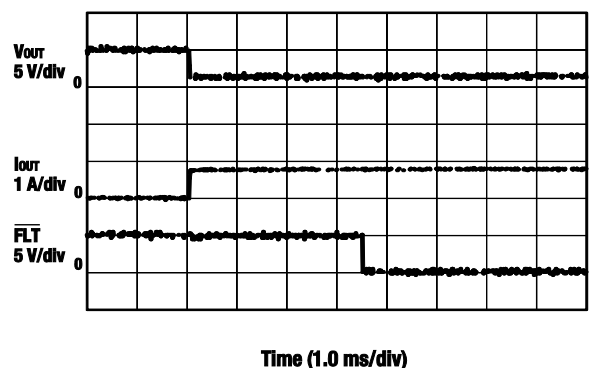

Figure 14. Fault Blanking Time
($V_{IN} = 5.0 V$)

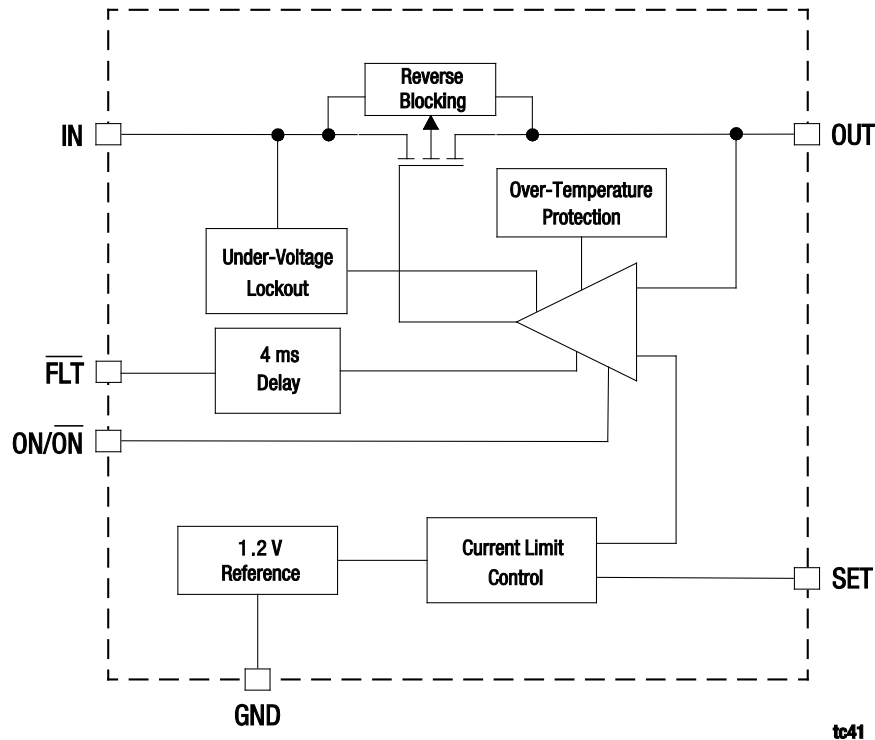

Figure 15. AAT4616A Functional Block Diagram

Functional Description

The AAT4616A is a single channel current limiting load switch that is intended to protect against short circuit and over-current events by current limiting to a preset level. This device also provides a reverse current blocking feature, on/off enable control, and a fault flag to notify a system controller of an over-current, short circuit or over-temperature event.

In the event of a load current that exceeds a user-programmed current limit level (ILIM), a high speed current limit loop limits the current in a microsecond and resets to low impedance once the short circuit condition is removed.

The AAT4616A is internally protected from thermal damage by an over-temperature detection circuit. If the die temperature reaches the internal thermal limit, the power device is switched off until the die temperature cools to a level below the thermal limit threshold. This device may operate in a thermal cycling state indefinitely or until the over-current condition is removed.

The AAT4616A operates with input voltages ranging from 2.4 V to 5.5 V which, along with its extremely low operating current, make it ideal for battery-powered applications. In cases where the input voltage drops to below 2.4 V, the AAT4616A MOSFET is protected from entering the saturated region of operation by being automatically shut down by the UVLO circuit.

Current limit or over-temperature conditions are reported by the open drain FAULT output. A 4 ms blanking interval prevents false reporting during the charging of a capacitive load, which

typically occurs during device turn-on, but may also occur during a port hot plug-in event. The AAT4616A is ideally suited for protection of peripheral ports such as USB, RS232, and parallel ports.

Reverse Current Blocking

The reverse current blocking feature prevents current flowing from OUT to IN when the device is disabled. When the device is enabled, the electrical characteristics between IN and OUT are still similar to an ideal switch, and current can flow in either direction.

Application Information

Setting Current Limit

The AAT4616A current limit can be set by an external resistor (RSET) connected from the SET pin to GND. RSET can be calculated by the following equation:

$$R_{SET} = \frac{750 \text{ mA}}{I_{LIM}} \times 35 \text{ k}\Omega$$

where ILIM is in mA and RSET in kΩ.

Table 5 summarizes resistor values for current limit settings. Use 1% tolerance metal film resistors to program the desired current limit setting. Figure 16 shows the output current versus output voltage with RSET equal to 34.8 kΩ.

Table 5. Recommended 1% Tolerance Metal Film Resistors R_{SET} for Current Limit

| R _{SET} (kΩ) | Current Limit (mA) |
|-----------------------|--------------------|
| 86.6 | 300 |
| 51 | 500 |
| 34.8 | 750 |
| 26.1 | 1000 |
| 21.5 | 1200 |
| 18.2 | 1400 |
| 16.5 | 1600 |

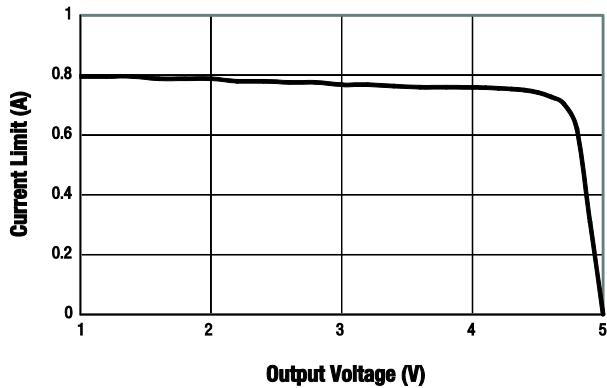

Figure 16. Current Limit vs Output Voltage with 34.8 kΩ R_{SET}

Input Capacitor

The input capacitor C_{IN} protects the power supply from current transients generated by the load attached to the AAT4616A. When a short circuit is suddenly applied to the output of the AAT4616A, a large current, limited only by the R_{DS(ON)} of the MOSFET, flows for less than 1 μs before the current limit circuitry activates. In this event, a moderately sized C_{IN} dramatically reduces the voltage transient seen by the power supply and by other circuitry upstream from the AAT4616A.

The extremely fast short-circuit response time of the AAT4616A reduces the size requirement for C_{IN}. C_{IN} should be located as close to the device VIN pin as practically possible. Ceramic, tantalum, or aluminum electrolytic capacitors are appropriate for C_{IN}. There is no specific capacitor Equivalent Series Resistance (ESR) requirement for C_{IN}. For higher current operation, ceramic capacitors are recommended for C_{IN} due to their inherent capability over tantalum capacitors to withstand input current surges from low impedance sources such as batteries in portable devices.

Output Capacitor

To ensure stability while the current limit is active, a low capacitance (approximately 0.47 μF) is required. No matter how large the output capacitor, the output current is limited to the value set by the AAT4616A current limiting circuitry, so very large output capacitors can be used.

For example, USB ports are specified to have at least 120 μF of capacitance downstream from their controlling power switch. The current limiting circuit allows an output capacitance of 1000 μF or more without disturbing the upstream power supply.

ON/ $\overline{\text{ON}}$ (Enable Input)

In many systems, power planes are controlled by integrated circuits that run at lower voltages than the power planes, themselves. The enable input (ON/ $\overline{\text{ON}}$) of the AAT4616A has low and high threshold voltages that accommodate this condition. The threshold voltages are compatible with 5 V TTL and 2.5 V ~ 5 V CMOS systems.

Both active high and active low options are available.

Connecting to Capacitive Load

When the AAT4616A is switched onto a capacitive load, the device charges the output capacitive load at a rate no greater than the current limit setting.

FAULT Output

The FAULT Flag $\overline{\text{FLT}}$ is provided to alert the system if an AAT4616A load is not receiving sufficient voltage to operate properly. If current limit or over-temperature circuits in any combination are active for more than approximately 4 ms, the FAULT Flag is pulled to ground through an approximately 100 Ω resistor.

The filtering of voltage or current transients of less than 4 ms prevents capacitive loads connected to the AAT4616A output from activating the FAULT Flag when they are initially attached. Pull-up resistances of 10 kΩ to 100 kΩ are recommended. Since $\overline{\text{FLT}}$ is an open-drain terminal; it may be pulled up to any unrelated voltage less than the maximum operating voltage of 5.5 V, allowing for level shifting between circuits.

Thermal Considerations

Since the AAT4616A has internal current limit and over-temperature protection, junction temperature is rarely a concern. However, if the application requires large currents in a hot environment, it is possible that temperature, rather than current limit, is the dominant regulating condition. In these applications, the maximum current available without risk of an over-temperature condition must be calculated. The maximum internal temperature while the current limit is inactive can be calculated using the following equation:

$$T_{J(MAX)} = I_{MAX(OUT_SW(MAX)}^2 \times R_{DS(ON)(MAX)} \times R_{\theta JA} + T_{A(MAX)} \tag{1}$$

Where:

I_{MAX} is the maximum current required by the load.

$R_{DS(ON)(MAX)}$ is the maximum rated $R_{DS(ON)}$ of the AAT4616A at high temperature.

$R_{\theta JA}$ is the thermal resistance between the AAT4616A die and the board onto which it is mounted.

$T_{A(MAX)}$ is the maximum temperature that the PCB under the AAT4616A would be if the AAT4616A were not dissipating power.

Rearranging equation (1) to solve for I_{MAX} :

$$I_{MAX} = \sqrt{\frac{T_{SD(MIN)} - T_{A(MAX)}}{R_{DS(ON)} \times R_{\theta JA}}} \tag{2}$$

Note that $T_{J(MAX)}$ has been replaced by $T_{SD(MIN)}$, the minimum temperature required to activate the over-temperature protection feature of the AAT4616A. With the typical specification of 140 °C, a safe minimum value to use would be 125 °C.

For example, if an application is specified to operate in 50 °C environments, the PCB operates at temperatures as high as 85 °C. The application is sealed and its PCB is small, causing $R_{\theta JA}$ to be approximately 85 °C/W. Using equation (2):

$$I_{MAX} = \sqrt{\frac{125 - 85}{0.23 \times 85}}$$

Evaluation Board Information

The AAT4616A Evaluation Board schematic diagram is provided in Figure 17. The PCB layer details are shown in Figure 18, and Table 6 lists the Evaluation Board Bill of Materials (BOM).

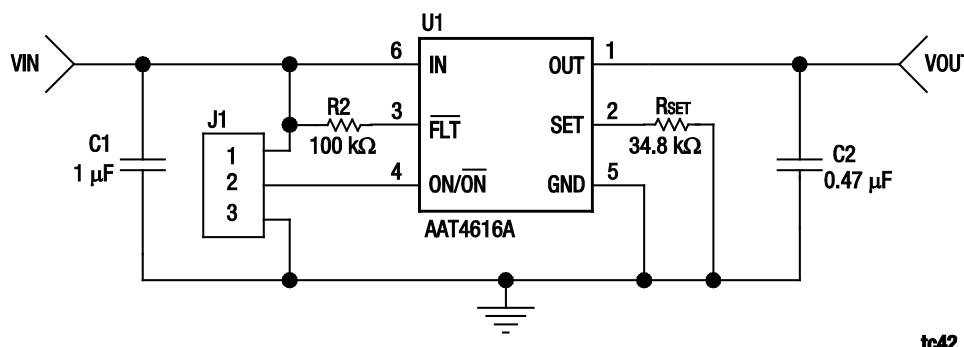

tc42

Figure 17. AAT4616A Evaluation Board Schematic

Table 6. AAT4616A Evaluation Board Bill of Materials (BOM)

| Component | Part Number | Description | Manufacturer |
|-----------|----------------|---|--------------|
| U1 | AAT4616AIPU-T1 | Current Limited Load Switch | Skyworks |
| C1 | GRM188R71C105K | Ceramic capacitor, 1 μF, 0603 X7R, 16 V, 10% | Murata |
| C2 | GRM188R71C474K | Ceramic capacitor, 0.47 μF, 0603 X7R, 16 V, 10% | Murata |
| RSET | Chip Resistor | Resistor, 34.8 kΩ, 1/16 W, 1%, 0603 SMD | Vishay |
| R2 | Chip Resistor | Resistor, 100 kΩ, 1/16 W, 1%, 0603 SMD | Vishay |

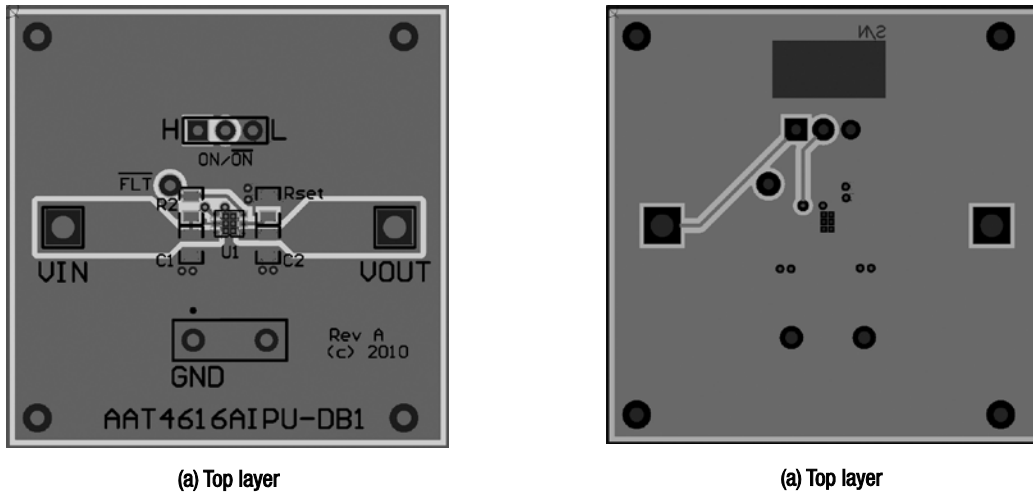
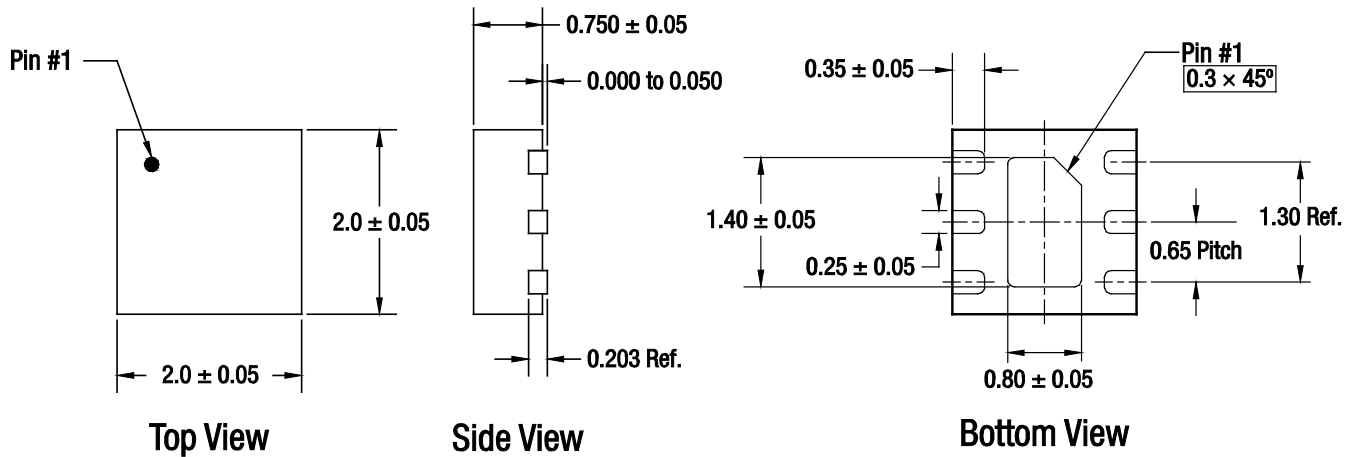

Figure 18. AAT4616A Evaluation Board Layer Details

Package Information

Package dimensions for the TDFN22-6 are shown in Figure 19, and tape and reel dimensions are provided in Figure 20.



Notes:

Dimensioning and tolerancing per ASME Y14.5M - 1994.
 Dimensions are in millimeters.
 Coplanarity applies to the exposed heat sink slug as well as the terminals.
 Dimension applies to metalized terminal, not measured in radius area.

S3565

Figure 19. AAT4616A TDFN22-6 Package Dimensions

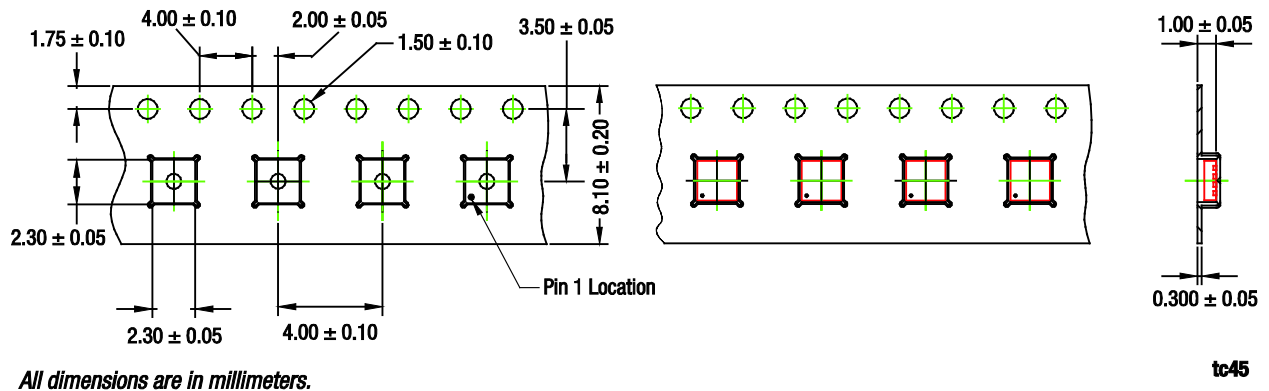

All dimensions are in millimeters.

Figure 20. AAT4616A Tape and Reel Dimensions

Ordering Information

| Model Name | Enable Input | Package | Marking (Note 1) | Manufacturing Part Number (Note 2) | Evaluation Board Part Number |
|---|--------------|----------|------------------|------------------------------------|------------------------------|
| AAT4616A Adjustable Current Limited Load Switch with Fault Flag | Active High | TDFN22-6 | R9XYY | AAT4616AIPU-1-T1 | AAT4616AIPU-1-EVB |
| | Active Low | TDFN22-6 | U4WBF | AAT4616AIPU-T1 | AAT4616AIPU-EVB |

Note 1: XYY = assembly and date code.

Note 2: Sample stock is generally held on part numbers listed in **BOLD**.

Copyright © 2013 Skyworks Solutions, Inc. All Rights Reserved.

Information in this document is provided in connection with Skyworks Solutions, Inc. ("Skyworks") products or services. These materials, including the information contained herein, are provided by Skyworks as a service to its customers and may be used for informational purposes only by the customer. Skyworks assumes no responsibility for errors or omissions in these materials or the information contained herein. Skyworks may change its documentation, products, services, specifications or product descriptions at any time, without notice. Skyworks makes no commitment to update the materials or information and shall have no responsibility whatsoever for conflicts, incompatibilities, or other difficulties arising from any future changes.

No license, whether express, implied, by estoppel or otherwise, is granted to any intellectual property rights by this document. Skyworks assumes no liability for any materials, products or information provided hereunder, including the sale, distribution, reproduction or use of Skyworks products, information or materials, except as may be provided in Skyworks Terms and Conditions of Sale.

THE MATERIALS, PRODUCTS AND INFORMATION ARE PROVIDED "AS IS" WITHOUT WARRANTY OF ANY KIND, WHETHER EXPRESS, IMPLIED, STATUTORY, OR OTHERWISE, INCLUDING FITNESS FOR A PARTICULAR PURPOSE OR USE, MERCHANTABILITY, PERFORMANCE, QUALITY OR NON-INFRINGEMENT OF ANY INTELLECTUAL PROPERTY RIGHT; ALL SUCH WARRANTIES ARE HEREBY EXPRESSLY DISCLAIMED. SKYWORKS DOES NOT WARRANT THE ACCURACY OR COMPLETENESS OF THE INFORMATION, TEXT, GRAPHICS OR OTHER ITEMS CONTAINED WITHIN THESE MATERIALS. SKYWORKS SHALL NOT BE LIABLE FOR ANY DAMAGES, INCLUDING BUT NOT LIMITED TO ANY SPECIAL, INDIRECT, INCIDENTAL, STATUTORY, OR CONSEQUENTIAL DAMAGES, INCLUDING WITHOUT LIMITATION, LOST REVENUES OR LOST PROFITS THAT MAY RESULT FROM THE USE OF THE MATERIALS OR INFORMATION, WHETHER OR NOT THE RECIPIENT OF MATERIALS HAS BEEN ADVISED OF THE POSSIBILITY OF SUCH DAMAGE.

Skyworks products are not intended for use in medical, lifesaving or life-sustaining applications, or other equipment in which the failure of the Skyworks products could lead to personal injury, death, physical or environmental damage. Skyworks customers using or selling Skyworks products for use in such applications do so at their own risk and agree to fully indemnify Skyworks for any damages resulting from such improper use or sale.

Customers are responsible for their products and applications using Skyworks products, which may deviate from published specifications as a result of design defects, errors, or operation of products outside of published parameters or design specifications. Customers should include design and operating safeguards to minimize these and other risks. Skyworks assumes no liability for applications assistance, customer product design, or damage to any equipment resulting from the use of Skyworks products outside of stated published specifications or parameters.

Skyworks, the Skyworks symbol, and "Breakthrough Simplicity" are trademarks or registered trademarks of Skyworks Solutions, Inc., in the United States and other countries. Third-party brands and names are for identification purposes only, and are the property of their respective owners. Additional information, including relevant terms and conditions, posted at www.skyworksinc.com, are incorporated by reference.