

- *RF Filter for Mobile Communication Applications*
- *No Matching Circuit Required*
- *3.0 x 3.0 x 1.3 mm Package*
- *Complies with Directive 2002/95/EC (RoHS)*
- *Moisture Sensitivity Level: 1*

SF2001E

**1960 MHz
SAW Filter**

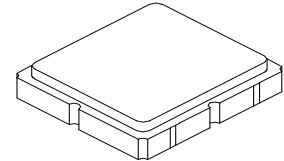

SM3030-6

Absolute Maximum Ratings

Rating	Value	Units
Maximum Input Power	+10	dBm
DC Voltage on any Non-ground Terminal	3	VDC
Storage Temperature Range in Tape and Reel	-40 to +85	°C
Maximum Soldering Profile, 5 cycles/10 seconds maximum	265	°C

Electrical Characteristics

Characteristic	Sym	Notes	Min	Typ	Max	Units
Nominal Operating Frequency	f_C			1960		MHz
Passband Insertion Loss, 1930 -1990 MHz	IL			2.35	4.0	dB
Amplitude Ripple, 1930 -1990 MHz				1.4	2.4	dB _{P-P}
Attenuation Referenced to 0 dB						
DC to 1870 MHz			25.0	32.0		dB
1870 to 1910 MHz			10.0	21.0		dB
2010 to 2040 MHz			4.5	10.0		dB
2040 to 2050 MHz			20.0	50		dB
2050 to 3800 MHz			25.0	29.0		dB
3800 to 5000 MHz			22.0	15.0		dB
5000 to 6000 MHz			10.0	15.0		
VSWR, 1930 to 1990 MHz				1.7	2.4	
Source impedance	Z_S			50		Ω
Load impedance	Z_L			50		Ω
Operating Temperature	T_A		-30		+80	°C

Case Style	SM3030-6 3 x 3 mm Nominal Footprint
Lid Symbolization (Y=year, WW=week S=shift)	652 <u>YWWS</u>

Electrical Connections

Connection	Terminals
Input	2
Output	5
Ground	All others



CAUTION: Electrostatic Sensitive Device. Observe precautions for handling.

NOTES:

1. The design, manufacturing process, and specifications of this device are subject to change.
2. US or International patents may apply.
3. RoHS compliant from the first date of manufacture.

Frequency Characteristics:

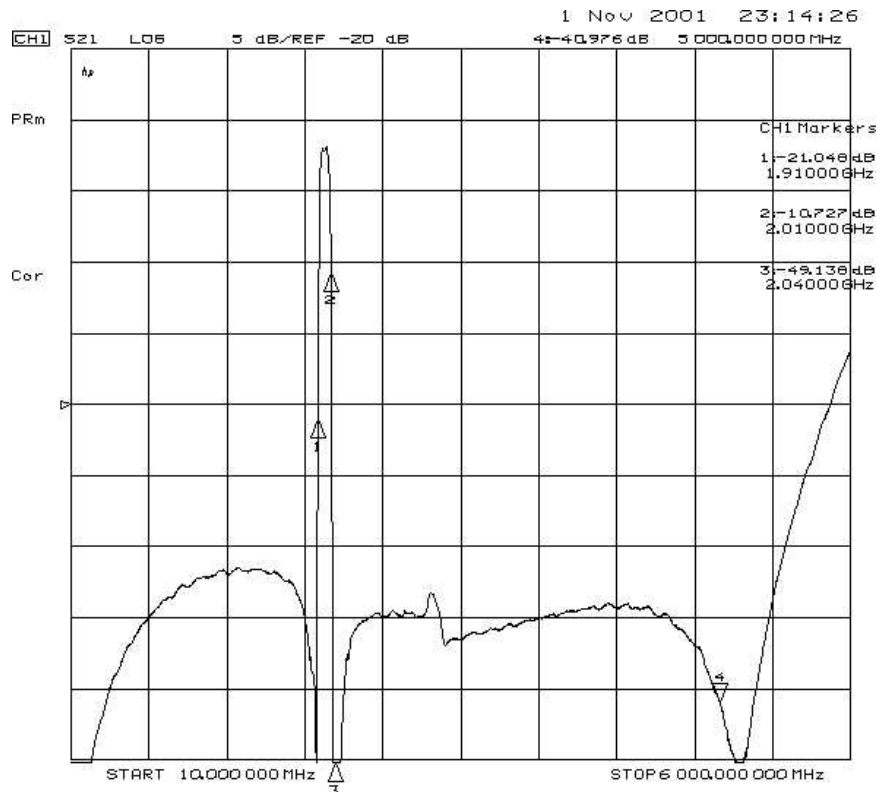
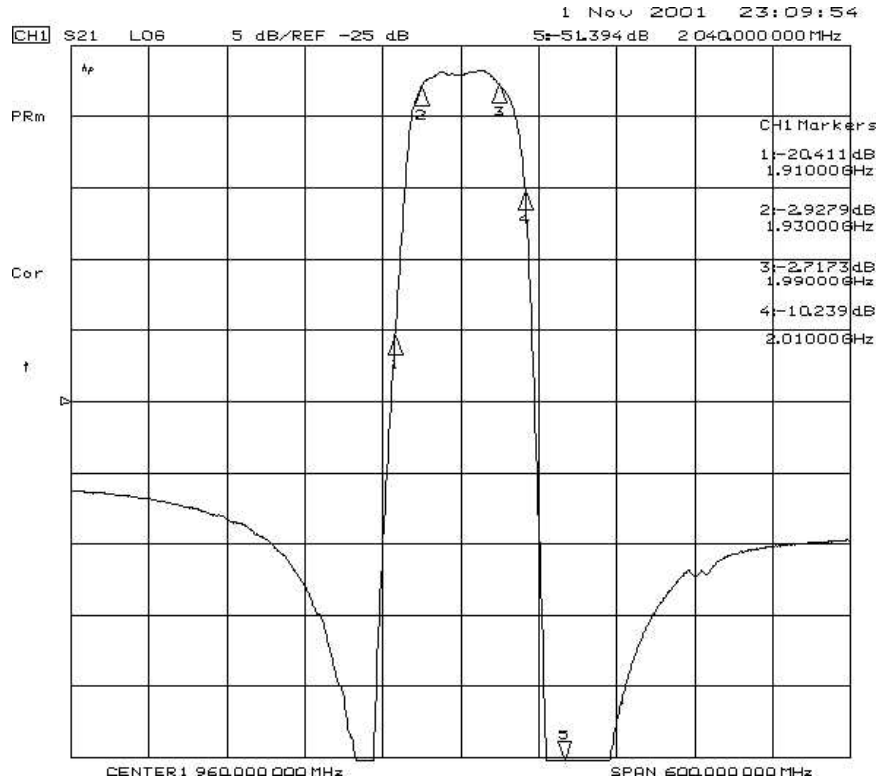

Reflections Functions:

S11 VSWR

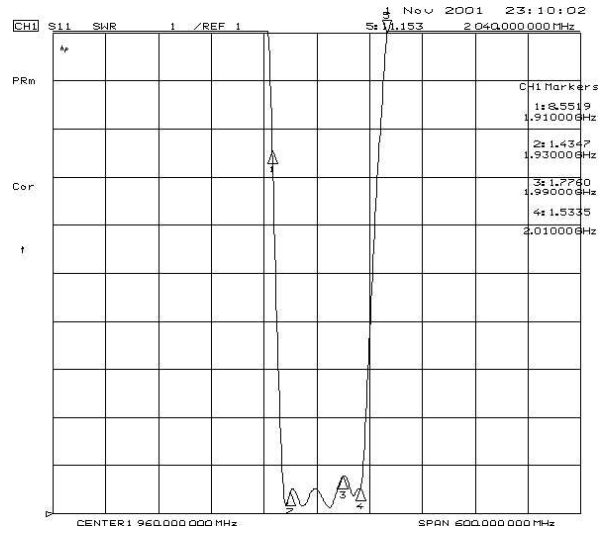
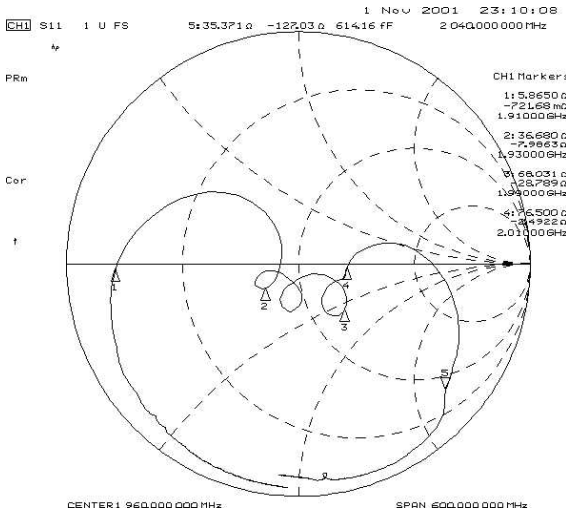

S22 VSWR

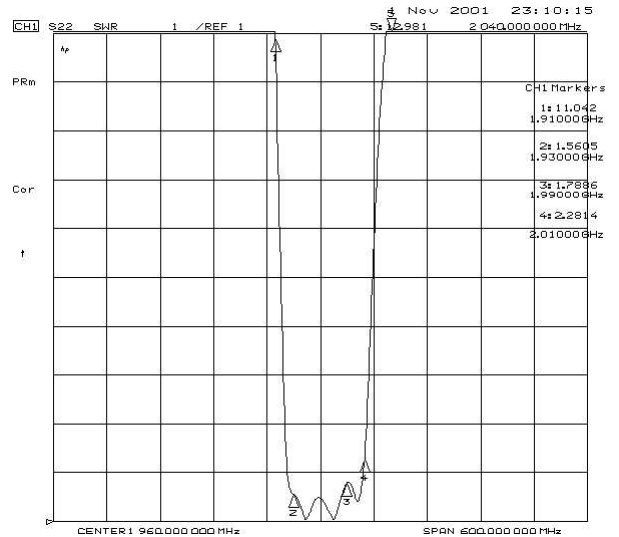
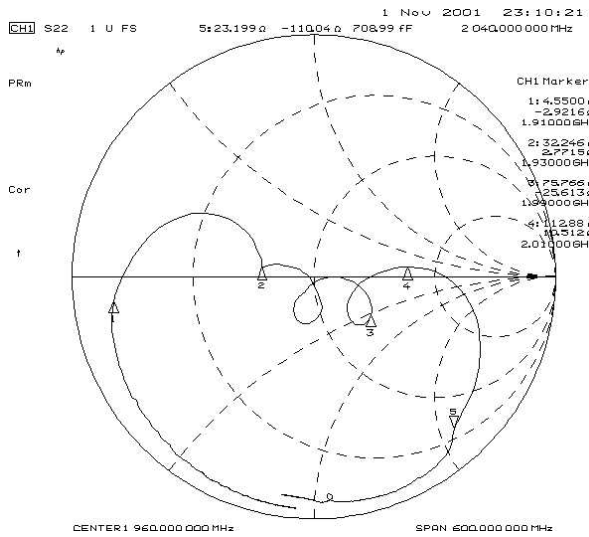

SM3030-6 Case

6-Terminal Ceramic Surface-Mount Case 3.0 X 3.0 mm Nominal Footprint



PCB Footprint Top View

Case and PCB Footprint Dimensions

Dimension	mm			Inches		
	Min	Nom	Max	Min	Nom	Max
A	2.87	3.00	3.13	0.113	0.118	0.123
B	2.87	3.00	3.13	0.113	0.118	0.123
C	1.12	1.25	1.38	0.044	0.049	0.054
D	0.77	0.90	1.03	0.030	0.035	0.040
E	2.67	2.80	2.93	0.105	0.110	0.115
F	1.47	1.60	1.73	0.058	0.063	0.068
G	0.72	0.85	0.98	0.028	0.033	0.038
H	1.37	1.50	1.63	0.054	0.059	0.064
I	0.47	0.60	0.73	0.019	0.024	0.029
J	1.17	1.30	1.43	0.046	0.051	0.056
K		3.20			0.126	
L		1.70			0.067	
M		1.05			0.041	
N		0.81			0.032	
O		0.38			0.015	

Case Materials

Materials	
Solder Pad Plating	0.3 to 1.0 μm Gold over 1.27 to 8.89 μm Nickel
Lid Plating	2.0 to 3.0 μm Nickel
Body	Al_2O_3 Ceramic

Top View

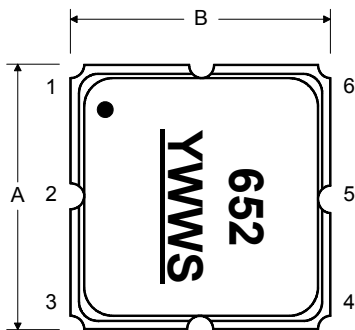

Bottom View

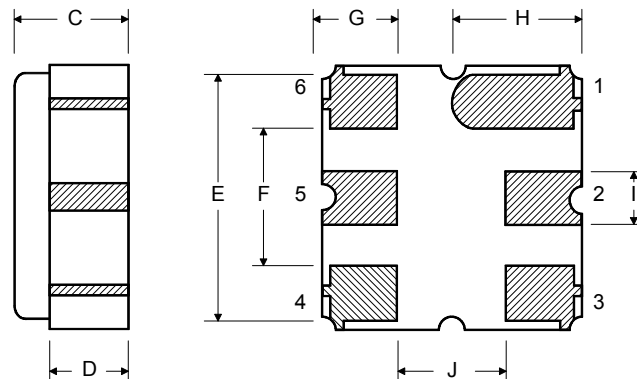

Tape and Reel Specifications

Tape and Reel Standard per ANSI/EIA-481

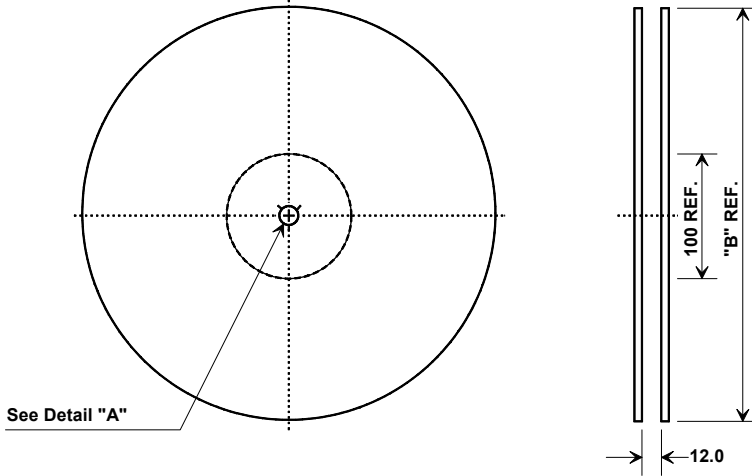

"B"		Quantity Per Reel
Inches	millimeters	
7	178	500
13	330	3000

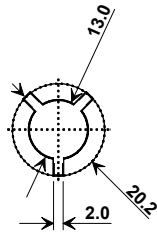

COMPONENT ORIENTATION

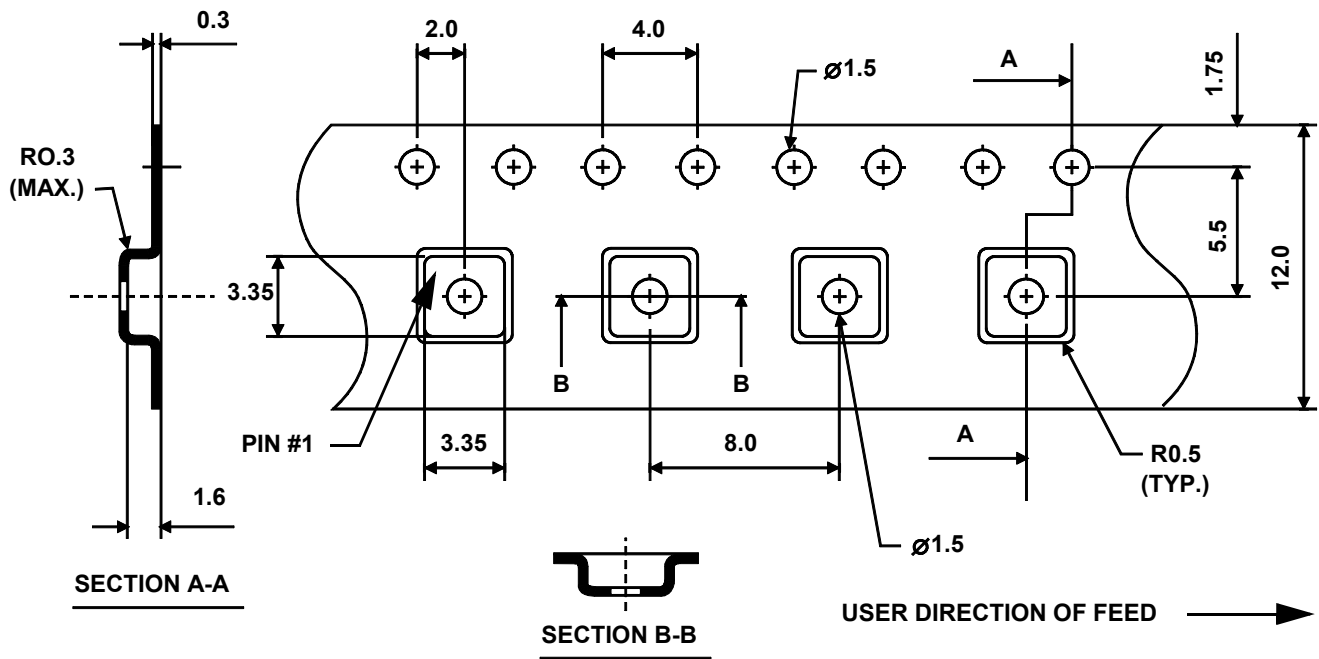

Recommended Reflow Profile

1. Preheating shall be fixed at 150~180°C for 60~90 seconds.
2. Ascending time to preheating temperature 150°C shall be 30 seconds min.
3. Heating shall be fixed at 220°C for 50~80 seconds and at 260°C+0/-5°C peak (10 seconds).
4. Time: 5 times maximum.

