



# Product Change Notification

## TE Connectivity

Product Change Notification: P-22-023558

PCN Date: 27-OCT-22

TE would like to inform you of the following change(s) to the listed TE Connectivity Product. In case of any further questions about this change(s), please contact your TE Connectivity Sales Engineer. Affected part, drawing and/or specification numbers are listed on the attached sheet(s).

**General Product Description:**  
Flame-Proof Power Metal Oxide Resistors - Type ROX Series

**Description of Changes**  
Change to the datasheet to clarify Operating Temperature and derating chart. No Change to product.  
**Other attachments:**  
[Old Data Sheet \(Rev. H\)](#)  
[New Data Sheet \(Rev. J\)](#)

**Reason for Changes:**  
Document clarification. Operating temperature and derating chart appeared to be in conflict. Both items clarified. No Change to product.

**Estimated Dates:**

<b>Last Order Date</b> (Obsolete Parts Only):	<b>First Date To Ship</b> (Changed Parts Only):
	28-NOV-2022
<b>Last Ship Date</b> (Obsolete Parts Only):	<b>Last Date for Mixed Shipments:</b> (Changed Parts Only):
	No Mixed Shipments

**Part Number(s) being Modified:**

Part Number	Part Discontinued per PCN	Customer Drawing	Customer Part Number	Alias Part Number(s)	Substitute Part Number	Substitute Alias Part Number(s)	Description Of Difference
<a href="#">1-1625885-1</a>	NO			"ROX1SJ100K", "ROX1SJ100KJIT"			
<a href="#">1-1625885-2</a>	NO			"ROX1SJ100R", "ROX1SJ100RJIT"			
<a href="#">1-1625885-3</a>	NO			"ROX1SJ10K", "ROX1SJ10KJIT"			
<a href="#">1-1625885-4</a>	NO			"ROX1SJ10R", "ROX1SJ10RJIT"			
<a href="#">1-1625885-5</a>	NO			"ROX1SJ120K", "ROX1SJ120KJIT"			
<a href="#">1-1625885-7</a>	NO			"ROX1SJ120R", "ROX1SJ120RJIT"			
<a href="#">1-1625885-9</a>	NO			"ROX1SJ12R", "ROX1SJ12RJIT"			
<a href="#">1-1625886-0</a>	NO			"ROX1SJ39K", "ROX1SJ39KJIT"			
<a href="#">1-1625886-1</a>	NO			"ROX1SJ39R", "ROX1SJ39RJIT"			
<a href="#">1-1625886-2</a>	NO			"ROX1SJ3K3", "ROX1SJ3K3JIT"			
<a href="#">1-1625886-3</a>	NO			"ROX1SJ3K9", "ROX1SJ3K9JIT"			
<a href="#">1-1625886-4</a>	NO			"ROX1SJ3R3", "ROX1SJ3R3JIT"			
<a href="#">1-1625886-7</a>	NO			"ROX1SJ470K", "ROX1SJ470KJIT"			
<a href="#">1-1625886-8</a>	NO			"ROX1SJ470R", "ROX1SJ470RJIT"			
<a href="#">1-1625886-9</a>	NO			"ROX1SJ47K", "ROX1SJ47KJIT"			
<a href="#">1-1625890-0</a>	NO			"ROX2SJ12R"			

Part Number	Part Discontinued per PCN	Customer Drawing	Customer Part Number	Alias Part Number(s)	Substitute Part Number	Substitute Alias Part Number(s)	Description Of Difference
<a href="#">1-1625890-1</a>	NO			"ROX2SJ150K"			
<a href="#">1-1625890-2</a>	NO			"ROX2SJ150R"			
<a href="#">1-1625890-4</a>	NO			"ROX2SJ15K"			
<a href="#">1-1625890-5</a>	NO			"ROX2SJ15R"			
<a href="#">1-1625890-6</a>	NO			"ROX2SJ180K"			
<a href="#">1-1625890-8</a>	NO			"ROX2SJ18K"			
<a href="#">1-1625892-0</a>	NO			"ROX3SJ10K"			
<a href="#">1-1625892-1</a>	NO			"ROX3SJ10R"			
<a href="#">1-1625892-2</a>	NO			"ROX3SJ12K"			
<a href="#">1-1625892-3</a>	NO			"ROX3SJ12R"			
<a href="#">1-1625892-4</a>	NO			"ROX3SJ150K"			
<a href="#">1-1625892-5</a>	NO			"ROX3SJ150R"			
<a href="#">1-1625892-6</a>	NO			"ROX3SJ15K"			
<a href="#">1-1625892-7</a>	NO			"ROX3SJ15R"			
<a href="#">1-1625892-8</a>	NO			"ROX3SJ180K"			
<a href="#">1-1625892-9</a>	NO			"ROX3SJ180R"			
<a href="#">1-1625893-0</a>	NO			"ROX5SJ51K"			
<a href="#">1-1625893-3</a>	NO			"ROX5SG22R"			
<a href="#">1-1625893-6</a>	NO			"ROX5SJ510K"			
<a href="#">1-1676123-1</a>	NO			"ROX05SJ2R2"			
<a href="#">1-1676123-7</a>	NO			"ROX05SJ3R9"			
<a href="#">1-2176411-1</a>	NO			"ROX05SJ30K"			
<a href="#">1-2176412-0</a>	NO			"ROX5SSJ12R"			
<a href="#">1-2176412-2</a>	NO			"ROX5SSJ15R"			
<a href="#">1-2176412-3</a>	NO			"ROX5SSJ16R"			
<a href="#">1-2176412-4</a>	NO			"ROX5SSJ18R"			
<a href="#">1-2176412-5</a>	NO			"ROX5SSJ20R"			
<a href="#">1-2176412-6</a>	NO			"ROX5SSJ22R"			
<a href="#">1-2176412-7</a>	NO			"ROX5SSJ24R"			
<a href="#">1-2176412-8</a>	NO			"ROX5SSJ27R"			
<a href="#">1-2176412-9</a>	NO			"ROX5SSJ30R"			
<a href="#">1-2176414-5</a>	NO			"ROX7J75R"			
<a href="#">1-2176415-0</a>	NO			"ROX8J68R"			
<a href="#">1-2176415-1</a>	NO			"ROX8J75R"			
<a href="#">1625881-2</a>	NO			"ROX1G220R"			
<a href="#">1625881-3</a>	NO			"ROX1G270R"			
<a href="#">1625881-6</a>	NO			"ROX1G100R"			
<a href="#">1625885-6</a>	NO			"ROX1SJR22"			
<a href="#">1625885-7</a>	NO			"ROX1SJR33"			
<a href="#">1625886-2</a>	NO			"ROX1SJ330K", "ROX1SJ330KJIT"			
<a href="#">1625886-4</a>	NO			"ROX1SJ330R", "ROX1SJ330RJIT"			
<a href="#">1625886-5</a>	NO			"ROX1SJ33K", "ROX1SJ33KJIT"			
<a href="#">1625886-9</a>	NO			"ROX1SJ390R", "ROX1SJ390RJIT"			
<a href="#">1625887-2</a>	NO			"ROX2G82R"			
<a href="#">1625888-2</a>	NO			"ROX2J180R"			
<a href="#">1625889-7</a>	NO			"ROX2SG100K"			
<a href="#">1625890-2</a>	NO			"ROX2SJ100K"			
<a href="#">1625890-4</a>	NO			"ROX2SJ100R"			
<a href="#">1625890-5</a>	NO			"ROX2SJ10K"			
<a href="#">1625890-6</a>	NO			"ROX2SJ10R"			
<a href="#">1625890-7</a>	NO			"ROX2SJ120K"			
<a href="#">1625890-8</a>	NO			"ROX2SJ120R"			
<a href="#">1625890-9</a>	NO			"ROX2SJ12K"			
<a href="#">1625892-1</a>	NO			"ROX3SJR10"			
<a href="#">1625892-2</a>	NO			"ROX3SJR22"			
<a href="#">1625892-4</a>	NO			"ROX3SJR33"			
<a href="#">1625892-5</a>	NO			"ROX3SJR47"			
<a href="#">1625892-6</a>	NO			"ROX3SJR51"			
<a href="#">1625892-8</a>	NO			"ROX3SJ100K"			
<a href="#">1625892-9</a>	NO			"ROX3SJ100R"			
<a href="#">1625893-2</a>	NO			"ROX5SJ39K"			
<a href="#">1625893-4</a>	NO			"ROX5SJ22R"			

Part Number	Part Discontinued per PCN	Customer Drawing	Customer Part Number	Alias Part Number(s)	Substitute Part Number	Substitute Alias Part Number(s)	Description Of Difference
<a href="#">1625893-5</a>	NO			"ROX5SJ47K"			
<a href="#">1625893-6</a>	NO			"ROX5SJ150K"			
<a href="#">1625893-7</a>	NO			"ROX5SJ82K"			
<a href="#">1625893-8</a>	NO			"ROX5SJ91K"			
<a href="#">1625893-9</a>	NO			"ROX5SJ100K"			
<a href="#">1879072-7</a>	NO			"ROX3SF390R", "ROX3SG390R"			
<a href="#">2-1625885-3</a>	NO			"ROX1SJ150R", "ROX1SJ150RJIT"			
<a href="#">2-1625885-4</a>	NO			"ROX1SJ15K", "ROX1SJ15KJIT"			
<a href="#">2-1625885-5</a>	NO			"ROX1SJ15R", "ROX1SJ15RJIT"			
<a href="#">2-1625885-6</a>	NO			"ROX1SJ180K", "ROX1SJ180KJIT"			
<a href="#">2-1625885-7</a>	NO			"ROX1SJ180R", "ROX1SJ180RJIT"			
<a href="#">2-1625885-8</a>	NO			"ROX1SJ18K", "ROX1SJ18KJIT"			
<a href="#">2-1625886-0</a>	NO			"ROX1SJ47R", "ROX1SJ47RJIT"			
<a href="#">2-1625886-1</a>	NO			"ROX1SJ4K7", "ROX1SJ4K7JIT"			
<a href="#">2-1625886-2</a>	NO			"ROX1SJ4R7", "ROX1SJ4R7JIT"			
<a href="#">2-1625886-3</a>	NO			"ROX1SJ560K"			
<a href="#">2-1625886-4</a>	NO			"ROX1SJ560R", "ROX1SJ560RJIT"			
<a href="#">2-1625886-5</a>	NO			"ROX1SJ56K", "ROX1SJ56KJIT"			
<a href="#">2-1625886-6</a>	NO			"ROX1SJ56R", "ROX1SJ56RJIT"			
<a href="#">2-1625886-9</a>	NO			"ROX1SJ5K6", "ROX1SJ5K6JIT"			
<a href="#">2-1625890-0</a>	NO			"ROX2SJ1K0"			
<a href="#">2-1625890-1</a>	NO			"ROX2SJ1K2"			
<a href="#">2-1625890-3</a>	NO			"ROX2SJ1K5"			
<a href="#">2-1625890-4</a>	NO			"ROX2SJ1K8"			
<a href="#">2-1625890-6</a>	NO			"ROX2SJ1M0"			
<a href="#">2-1625890-9</a>	NO			"ROX2SJ1R8"			
<a href="#">2-1625892-0</a>	NO			"ROX3SJ18R"			
<a href="#">2-1625892-1</a>	NO			"ROX3SJ1K0"			
<a href="#">2-1625892-2</a>	NO			"ROX3SJ1K2"			
<a href="#">2-1625892-3</a>	NO			"ROX3SJ1K5"			
<a href="#">2-1625892-4</a>	NO			"ROX3SJ1K8"			
<a href="#">2-1625892-5</a>	NO			"ROX3SJ1M0"			
<a href="#">2-1625892-6</a>	NO			"ROX3SJ1R0"			
<a href="#">2-1625892-7</a>	NO			"ROX3SJ1R8"			
<a href="#">2-1625892-8</a>	NO			"ROX3SJ20K"			
<a href="#">2-2176412-0</a>	NO			"ROX5SSJ33R"			
<a href="#">2-2176412-2</a>	NO			"ROX5SSJ39R"			
<a href="#">2-2176412-4</a>	NO			"ROX5SSJ47R"			
<a href="#">2-2176412-5</a>	NO			"ROX5SSJ51R"			
<a href="#">2-2176412-6</a>	NO			"ROX5SSJ56R"			
<a href="#">2-2176412-7</a>	NO			"ROX5SSJ62R"			
<a href="#">2-2176412-8</a>	NO			"ROX5SSJ68R"			
<a href="#">2-2176412-9</a>	NO			"ROX5SSJ75R"			
<a href="#">2-2176414-7</a>	NO			"ROX7J240R"			
<a href="#">2-2176415-3</a>	NO			"ROX8J240R"			
<a href="#">2-2176416-1</a>	NO			"ROX9J360R"			
<a href="#">2176412-1</a>	NO			"ROX5SSJ5R1"			
<a href="#">2176412-2</a>	NO			"ROX5SSJ5R6"			
<a href="#">2176412-3</a>	NO			"ROX5SSJ6R2"			
<a href="#">2176412-4</a>	NO			"ROX5SSJ6R8"			
<a href="#">2176412-6</a>	NO			"ROX5SSJ8R2"			
<a href="#">2176412-8</a>	NO			"ROX5SSJ10R"			

Part Number	Part Discontinued per PCN	Customer Drawing	Customer Part Number	Alias Part Number(s)	Substitute Part Number	Substitute Alias Part Number(s)	Description Of Difference
<a href="#">2176412-9</a>	NO			"ROX5SSJ11R"			
<a href="#">2176413-1</a>	NO			"ROX5SSJ68K"			
<a href="#">2176413-2</a>	NO			"ROX5SSJ75K"			
<a href="#">2176413-3</a>	NO			"ROX5SSJ82K"			
<a href="#">2176413-5</a>	NO			"ROX5SSJ100K"			
<a href="#">3-1625885-0</a>	NO			"ROX1SJ18R"			
<a href="#">3-1625885-1</a>	NO			"ROX1SJ1K0", "ROX1SJ1K0JIT"			
<a href="#">3-1625885-2</a>	NO			"ROX1SJ1K2", "ROX1SJ1K2JIT"			
<a href="#">3-1625885-4</a>	NO			"ROX1SJ1K5", "ROX1SJ1K5JIT"			
<a href="#">3-1625885-5</a>	NO			"ROX1SJ1K8", "ROX1SJ1K8JIT"			
<a href="#">3-1625885-6</a>	NO			"ROX1SJ1M0", "ROX1SJ1M0JIT"			
<a href="#">3-1625885-8</a>	NO			"ROX1SJ1R0", "ROX1SJ1R0JIT"			
<a href="#">3-1625886-0</a>	NO			"ROX1SJ5R6", "ROX1SJ5R6JIT"			
<a href="#">3-1625886-3</a>	NO			"ROX1SJ680R", "ROX1SJ680RJIT"			
<a href="#">3-1625886-6</a>	NO			"ROX1SJ68R", "ROX1SJ68RJIT"			
<a href="#">3-1625890-0</a>	NO			"ROX2SJ220K"			
<a href="#">3-1625890-1</a>	NO			"ROX2SJ220R"			
<a href="#">3-1625890-2</a>	NO			"ROX2SJ22K"			
<a href="#">3-1625890-3</a>	NO			"ROX2SJ22R"			
<a href="#">3-1625890-4</a>	NO			"ROX2SJ270K"			
<a href="#">3-1625890-5</a>	NO			"ROX2SJ270R"			
<a href="#">3-1625890-6</a>	NO			"ROX2SJ27K"			
<a href="#">3-1625892-0</a>	NO			"ROX3SJ220K"			
<a href="#">3-1625892-1</a>	NO			"ROX3SJ220R"			
<a href="#">3-1625892-2</a>	NO			"ROX3SJ22K"			
<a href="#">3-1625892-3</a>	NO			"ROX3SJ22R"			
<a href="#">3-1625892-4</a>	NO			"ROX3SJ270R"			
<a href="#">3-1625892-5</a>	NO			"ROX3SJ27K"			
<a href="#">3-1625892-6</a>	NO			"ROX3SJ27R"			
<a href="#">3-1625892-7</a>	NO			"ROX3SJ2K2"			
<a href="#">3-1625892-8</a>	NO			"ROX3SJ2K7"			
<a href="#">3-1625892-9</a>	NO			"ROX3SJ2R2"			
<a href="#">3-1676123-5</a>	NO			"ROX05SJ22R"			
<a href="#">3-2176412-1</a>	NO			"ROX5SSJ91R"			
<a href="#">3-2176412-2</a>	NO			"ROX5SSJ100R"			
<a href="#">3-2176412-4</a>	NO			"ROX5SSJ120R"			
<a href="#">3-2176412-5</a>	NO			"ROX5SSJ130R"			
<a href="#">3-2176412-6</a>	NO			"ROX5SSJ150R"			
<a href="#">3-2176412-8</a>	NO			"ROX5SSJ180R"			
<a href="#">3-2176412-9</a>	NO			"ROX5SSJ200R"			
<a href="#">4-1625885-3</a>	NO			"ROX1SJ220K", "ROX1SJ220KJIT"			
<a href="#">4-1625885-4</a>	NO			"ROX1SJ220R", "ROX1SJ220RJIT"			
<a href="#">4-1625885-6</a>	NO			"ROX1SJ22K", "ROX1SJ22KJIT"			
<a href="#">4-1625885-7</a>	NO			"ROX1SJ22R", "ROX1SJ22RJIT"			
<a href="#">4-1625886-2</a>	NO			"ROX1SJ820R", "ROX1SJ820RJIT"			
<a href="#">4-1625886-4</a>	NO			"ROX1SJ82R"			
<a href="#">4-1625886-5</a>	NO			"ROX1SJ8K2"			
<a href="#">4-1625890-1</a>	NO			"ROX2SJ330R"			
<a href="#">4-1625890-2</a>	NO			"ROX2SJ33K"			
<a href="#">4-1625890-3</a>	NO			"ROX2SJ33R"			
<a href="#">4-1625890-5</a>	NO			"ROX2SJ39K"			
<a href="#">4-1625890-7</a>	NO			"ROX2SJ3K3"			

Part Number	Part Discontinued per PCN	Customer Drawing	Customer Part Number	Alias Part Number(s)	Substitute Part Number	Substitute Alias Part Number(s)	Description Of Difference
<a href="#">4-1625890-8</a>	NO			"ROX2SJ3K9"			
<a href="#">4-1625892-1</a>	NO			"ROX3SJ330R"			
<a href="#">4-1625892-2</a>	NO			"ROX3SJ33K"			
<a href="#">4-1625892-3</a>	NO			"ROX3SJ33R"			
<a href="#">4-1625892-4</a>	NO			"ROX3SJ390R"			
<a href="#">4-1625892-5</a>	NO			"ROX3SJ39K"			
<a href="#">4-1625892-7</a>	NO			"ROX3SJ3K3"			
<a href="#">4-1625892-8</a>	NO			"ROX3SJ3K9"			
<a href="#">4-1625892-9</a>	NO			"ROX3SJ3R3"			
<a href="#">4-2176412-0</a>	NO			"ROX5SSJ220R"			
<a href="#">4-2176412-1</a>	NO			"ROX5SSJ240R"			
<a href="#">4-2176412-2</a>	NO			"ROX5SSJ270R"			
<a href="#">4-2176412-3</a>	NO			"ROX5SSJ300R"			
<a href="#">4-2176412-4</a>	NO			"ROX5SSJ330R"			
<a href="#">4-2176412-6</a>	NO			"ROX5SSJ390R"			
<a href="#">4-2176412-8</a>	NO			"ROX5SSJ470R"			
<a href="#">4-2176412-9</a>	NO			"ROX5SSJ510R"			
<a href="#">5-1625885-1</a>	NO			"ROX1SJ27K", "ROX1SJ27KJIT"			
<a href="#">5-1625885-2</a>	NO			"ROX1SJ27R", "ROX1SJ27RJIT"			
<a href="#">5-1625885-3</a>	NO			"ROX1SJ2K2", "ROX1SJ2K2JIT"			
<a href="#">5-1625885-4</a>	NO			"ROX1SJ2K7", "ROX1SJ2K7JIT"			
<a href="#">5-1625885-5</a>	NO			"ROX1SJ2R2", "ROX1SJ2R2JIT"			
<a href="#">5-1625885-6</a>	NO			"ROX1SJ2R7", "ROX1SJ2R7JIT"			
<a href="#">5-1625885-7</a>	NO			"ROX1SJ82K"			
<a href="#">5-1625890-0</a>	NO			"ROX2SJ470K"			
<a href="#">5-1625890-1</a>	NO			"ROX2SJ470R"			
<a href="#">5-1625890-2</a>	NO			"ROX2SJ47K"			
<a href="#">5-1625890-3</a>	NO			"ROX2SJ47R"			
<a href="#">5-1625890-4</a>	NO			"ROX2SJ4K7"			
<a href="#">5-1625890-5</a>	NO			"ROX2SJ4R7"			
<a href="#">5-1625892-1</a>	NO			"ROX3SJ470K"			
<a href="#">5-1625892-2</a>	NO			"ROX3SJ470R"			
<a href="#">5-1625892-3</a>	NO			"ROX3SJ47K"			
<a href="#">5-1625892-4</a>	NO			"ROX3SJ47R"			
<a href="#">5-1625892-5</a>	NO			"ROX3SJ4K7"			
<a href="#">5-1625892-6</a>	NO			"ROX3SJ4R7"			
<a href="#">5-1625892-8</a>	NO			"ROX3SJ560R"			
<a href="#">5-1625892-9</a>	NO			"ROX3SJ56K"			
<a href="#">5-1676123-1</a>	NO			"ROX05SJ100R"			
<a href="#">5-1676123-3</a>	NO			"ROX05SJ120R"			
<a href="#">5-2176412-0</a>	NO			"ROX5SSJ560R"			
<a href="#">5-2176412-1</a>	NO			"ROX5SSJ620R"			
<a href="#">5-2176412-2</a>	NO			"ROX5SSJ680R"			
<a href="#">5-2176412-3</a>	NO			"ROX5SSJ750R"			
<a href="#">5-2176412-4</a>	NO			"ROX5SSJ820R"			
<a href="#">5-2176412-5</a>	NO			"ROX5SSJ910R"			
<a href="#">5-2176412-6</a>	NO			"ROX5SSJ1K0"			
<a href="#">5-2176412-8</a>	NO			"ROX5SSJ1K2"			
<a href="#">5-2176414-4</a>	NO			"ROX7J3K3"			
<a href="#">5-2176414-8</a>	NO			"ROX7J4K7"			
<a href="#">6-1625890-0</a>	NO			"ROX2SJ56K"			
<a href="#">6-1625890-1</a>	NO			"ROX2SJ56R"			
<a href="#">6-1625890-3</a>	NO			"ROX2SJ5R6"			
<a href="#">6-1625890-4</a>	NO			"ROX2SJ680R"			
<a href="#">6-1625890-5</a>	NO			"ROX2SJ68K"			
<a href="#">6-1625890-7</a>	NO			"ROX2SJ6K8"			
<a href="#">6-1625890-8</a>	NO			"ROX2SJ6R8"			
<a href="#">6-1625890-9</a>	NO			"ROX2SJ820R"			
<a href="#">6-1625892-0</a>	NO			"ROX3SJ56R"			
<a href="#">6-1625892-1</a>	NO			"ROX3SJ5K6"			

Part Number	Part Discontinued per PCN	Customer Drawing	Customer Part Number	Alias Part Number(s)	Substitute Part Number	Substitute Alias Part Number(s)	Description Of Difference
<a href="#">6-1625892-4</a>	NO			"ROX3SJ680R"			
<a href="#">6-1625892-6</a>	NO			"ROX3SJ68K"			
<a href="#">6-1625892-7</a>	NO			"ROX3SJ68R"			
<a href="#">6-1625892-8</a>	NO			"ROX3SJ6K8"			
<a href="#">6-1676123-2</a>	NO			"ROX05SJ300R"			
<a href="#">6-1676123-3</a>	NO			"ROX05SJ330R"			
<a href="#">6-1676123-7</a>	NO			"ROX05SJ470R"			
<a href="#">6-2176412-2</a>	NO			"ROX5SSJ1K8"			
<a href="#">6-2176412-4</a>	NO			"ROX5SSJ2K2"			
<a href="#">6-2176412-5</a>	NO			"ROX5SSJ2K4"			
<a href="#">6-2176412-9</a>	NO			"ROX5SSJ3K6"			
<a href="#">6-2176414-2</a>	NO			"ROX7J6K8"			
<a href="#">6-2176414-4</a>	NO			"ROX7J8K2"			
<a href="#">6-2176416-6</a>	NO			"ROX9J27K"			
<a href="#">7-1625890-0</a>	NO			"ROX2SJ82K"			
<a href="#">7-1625890-1</a>	NO			"ROX2SJ82R"			
<a href="#">7-1625890-2</a>	NO			"ROX2SJ8K2"			
<a href="#">7-1625890-3</a>	NO			"ROX2SJ8R2"			
<a href="#">7-1625890-4</a>	NO			"ROX2SJ2K7"			
<a href="#">7-1625890-6</a>	NO			"ROX2SJR47"			
<a href="#">7-1625890-7</a>	NO			"ROX2SJ330K"			
<a href="#">7-1625892-0</a>	NO			"ROX3SJ6R8"			
<a href="#">7-1625892-1</a>	NO			"ROX3SJ820R"			
<a href="#">7-1625892-2</a>	NO			"ROX3SJ82K"			
<a href="#">7-1625892-3</a>	NO			"ROX3SJ82R"			
<a href="#">7-1625892-5</a>	NO			"ROX3SJ120R"			
<a href="#">7-1625892-6</a>	NO			"ROX3SJ8K2"			
<a href="#">7-1625892-7</a>	NO			"ROX3SJ18K"			
<a href="#">7-1676123-1</a>	NO			"ROX05SJ680R"			
<a href="#">7-1676123-2</a>	NO			"ROX05SJ750R"			
<a href="#">7-1676123-7</a>	NO			"ROX05SJ1K2"			
<a href="#">7-2176412-0</a>	NO			"ROX5SSJ3K9"			
<a href="#">7-2176412-1</a>	NO			"ROX5SSJ4K3"			
<a href="#">7-2176412-2</a>	NO			"ROX5SSJ4K7"			
<a href="#">7-2176412-3</a>	NO			"ROX5SSJ5K1"			
<a href="#">7-2176412-4</a>	NO			"ROX5SSJ5K6"			
<a href="#">7-2176412-6</a>	NO			"ROX5SSJ6K8"			
<a href="#">7-2176412-7</a>	NO			"ROX5SSJ7K5"			
<a href="#">7-2176414-8</a>	NO			"ROX7J33K"			
<a href="#">7-2176415-4</a>	NO			"ROX8J33K"			
<a href="#">7-2176415-5</a>	NO			"ROX8J36K"			
<a href="#">8-1625890-1</a>	NO			"ROX2SJ3R3"			
<a href="#">8-1625890-3</a>	NO			"ROX2SJ680K"			
<a href="#">8-1625890-5</a>	NO			"ROX2SJ200K"			
<a href="#">8-1625890-9</a>	NO			"ROX2SJ2R0"			
<a href="#">8-1625892-0</a>	NO			"ROX3SJ1R2"			
<a href="#">8-1625892-1</a>	NO			"ROX3SJ1R5"			
<a href="#">8-1625892-2</a>	NO			"ROX3SJ270K"			
<a href="#">8-1625892-3</a>	NO			"ROX3SJ330K"			
<a href="#">8-1625892-6</a>	NO			"ROX3SJ5R6"			
<a href="#">8-2176412-0</a>	NO			"ROX5SSJ10K"			
<a href="#">8-2176412-1</a>	NO			"ROX5SSJ11K"			
<a href="#">8-2176412-2</a>	NO			"ROX5SSJ12K"			
<a href="#">8-2176412-3</a>	NO			"ROX5SSJ13K"			
<a href="#">8-2176412-4</a>	NO			"ROX5SSJ15K"			
<a href="#">8-2176412-5</a>	NO			"ROX5SSJ16K"			
<a href="#">8-2176412-6</a>	NO			"ROX5SSJ18K"			
<a href="#">8-2176412-7</a>	NO			"ROX5SSJ20K"			
<a href="#">8-2176412-8</a>	NO			"ROX5SSJ22K"			
<a href="#">8-2176412-9</a>	NO			"ROX5SSJ24K"			
<a href="#">8-2176416-2</a>	NO			"ROX9J120K"			
<a href="#">9-1625890-1</a>	NO			"ROX2SG100R"			
<a href="#">9-1625890-2</a>	NO			"ROX2SJ62K"			
<a href="#">9-1625892-1</a>	NO			"ROX3SJ120K"			
<a href="#">9-1625892-2</a>	NO			"ROX3SJ2R7"			

Part Number	Part Discontinued per PCN	Customer Drawing	Customer Part Number	Alias Part Number(s)	Substitute Part Number	Substitute Alias Part Number(s)	Description Of Difference
<a href="#">9-1625892-3</a>	NO			"ROX3SJ15"			
<a href="#">9-1625892-9</a>	NO			"ROX3SJ36K"			
<a href="#">9-1676123-1</a>	NO			"ROX05SJ4K7"			
<a href="#">9-1676123-3</a>	NO			"ROX05SJ5K6"			
<a href="#">9-1676123-4</a>	NO			"ROX05SJ6K2"			
<a href="#">9-1676123-9</a>	NO			"ROX05SJ10K"			
<a href="#">9-2176412-0</a>	NO			"ROX5SSJ27K"			
<a href="#">9-2176412-1</a>	NO			"ROX5SSJ30K"			
<a href="#">9-2176412-2</a>	NO			"ROX5SSJ33K"			
<a href="#">9-2176412-4</a>	NO			"ROX5SSJ39K"			
<a href="#">9-2176412-6</a>	NO			"ROX5SSJ47K"			
<a href="#">9-2176412-7</a>	NO			"ROX5SSJ51K"			
<a href="#">9-2176412-8</a>	NO			"ROX5SSJ56K"			
<a href="#">9-2176412-9</a>	NO			"ROX5SSJ62K"			
<a href="#">9-2176414-0</a>	NO			"ROX7J100K"			
<a href="#">9-2176414-4</a>	NO			"ROX7J150K"			

The documents listed below are being modified. Related parts that are not explicitly listed on this PCN are not being modified or discontinued as per the PCN. The Last Order Date, Last Ship Date, First Date to Ship Changed Parts and last date for Mixed Shipments apply only to parts explicitly listed on this PCN.

**Document(s) Being Modified:**

Documents Number	Related Part Number	Customer Part Number	Current Revision	New Revision
<a href="#">1773271</a>	1-1625885-2, 1-1625885-1		J	

**Part Number(s) being Modified:**

Part Number	Part Discontinued per PCN	Customer Drawing	Customer Part Number	Alias Part Number(s)	Substitute Part Number	Substitute Alias Part Number(s)	Description Of Difference
<a href="#">1-1625885-2</a>	NO			"ROX1SJ100R", "ROX1SJ100RJIT"			
<a href="#">1-1625886-8</a>	NO			"ROX1SJ470R", "ROX1SJ470RJIT"			
<a href="#">1-2176412-3</a>	NO			"ROX5SSJ16R"			
<a href="#">1625890-4</a>	NO			"ROX2SJ100R"			
<a href="#">1625892-8</a>	NO			"ROX3SJ100K"			
<a href="#">2-1625890-3</a>	NO			"ROX2SJ1K5"			
<a href="#">3-2176412-4</a>	NO			"ROX5SSJ120R"			
<a href="#">4-2176412-0</a>	NO			"ROX5SSJ220R"			
<a href="#">4-2176412-3</a>	NO			"ROX5SSJ300R"			
<a href="#">5-2176412-6</a>	NO			"ROX5SSJ1K0"			
<a href="#">8-2176412-0</a>	NO			"ROX5SSJ10K"			
<a href="#">8-2176412-6</a>	NO			"ROX5SSJ18K"			

The documents listed below are being modified. Related parts that are not explicitly listed on this PCN are not being modified or discontinued as per the PCN. The Last Order

Date, Last Ship Date, First Date to Ship Changed Parts and last date for Mixed Shipments apply only to parts explicitly listed on this PCN.

Document(s) Being Modified:

Documents Number	Related Part Number	Customer Part Number	Current Revision	New Revision
<a href="#">1773271</a>	1-1625885-2		J	

Part Number(s) being Modified:

Part Number	Part Discontinued per PCN	Customer Drawing	Customer Part Number	Alias Part Number(s)	Substitute Part Number	Substitute Alias Part Number(s)	Description Of Difference
<a href="#">1-1625885-1</a>	NO			"ROX1SJ100K", "ROX1SJ100KJIT"			
<a href="#">1-1625885-2</a>	NO			"ROX1SJ100R", "ROX1SJ100RJIT"			
<a href="#">1-1625885-3</a>	NO			"ROX1SJ10K", "ROX1SJ10KJIT"			
<a href="#">1-1625885-4</a>	NO			"ROX1SJ10R", "ROX1SJ10RJIT"			
<a href="#">1-1625885-5</a>	NO			"ROX1SJ120K", "ROX1SJ120KJIT"			
<a href="#">1-1625885-7</a>	NO			"ROX1SJ120R", "ROX1SJ120RJIT"			
<a href="#">1-1625885-9</a>	NO			"ROX1SJ12R", "ROX1SJ12RJIT"			
<a href="#">1-1625886-0</a>	NO			"ROX1SJ39K", "ROX1SJ39KJIT"			
<a href="#">1-1625886-1</a>	NO			"ROX1SJ39R", "ROX1SJ39RJIT"			
<a href="#">1-1625886-2</a>	NO			"ROX1SJ3K3", "ROX1SJ3K3JIT"			
<a href="#">1-1625886-3</a>	NO			"ROX1SJ3K9", "ROX1SJ3K9JIT"			
<a href="#">1-1625886-4</a>	NO			"ROX1SJ3R3", "ROX1SJ3R3JIT"			
<a href="#">1-1625886-7</a>	NO			"ROX1SJ470K", "ROX1SJ470KJIT"			
<a href="#">1-1625886-8</a>	NO			"ROX1SJ470R", "ROX1SJ470RJIT"			
<a href="#">1-1625886-9</a>	NO			"ROX1SJ47K", "ROX1SJ47KJIT"			
<a href="#">1-1625890-0</a>	NO			"ROX2SJ12R"			
<a href="#">1-1625890-1</a>	NO			"ROX2SJ150K"			
<a href="#">1-1625890-2</a>	NO			"ROX2SJ150R"			
<a href="#">1-1625890-4</a>	NO			"ROX2SJ15K"			



Part Number	Part Discontinued per PCN	Customer Drawing	Customer Part Number	Alias Part Number(s)	Substitute Part Number	Substitute Alias Part Number(s)	Description Of Difference
<a href="#">1-1625890-5</a>	NO			"ROX2SJ15R"			
<a href="#">1-1625890-6</a>	NO			"ROX2SJ180K"			
<a href="#">1-1625890-8</a>	NO			"ROX2SJ18K"			
<a href="#">1-1625892-0</a>	NO			"ROX3SJ10K"			
<a href="#">1-1625892-1</a>	NO			"ROX3SJ10R"			
<a href="#">1-1625892-2</a>	NO			"ROX3SJ12K"			
<a href="#">1-1625892-3</a>	NO			"ROX3SJ12R"			
<a href="#">1-1625892-4</a>	NO			"ROX3SJ150K"			
<a href="#">1-1625892-5</a>	NO			"ROX3SJ150R"			
<a href="#">1-1625892-6</a>	NO			"ROX3SJ15K"			
<a href="#">1-1625892-7</a>	NO			"ROX3SJ15R"			
<a href="#">1-1625892-8</a>	NO			"ROX3SJ180K"			
<a href="#">1-1625892-9</a>	NO			"ROX3SJ180R"			
<a href="#">1-1625893-0</a>	NO			"ROX5SJ51K"			
<a href="#">1-1625893-3</a>	NO			"ROX5SG22R"			
<a href="#">1-1625893-6</a>	NO			"ROX5SJ510K"			
<a href="#">1-1676123-1</a>	NO			"ROX05SJ2R2"			
<a href="#">1-1676123-7</a>	NO			"ROX05SJ3R9"			
<a href="#">1-2176411-1</a>	NO			"ROX05SJ30K"			
<a href="#">1-2176412-0</a>	NO			"ROX5SSJ12R"			
<a href="#">1-2176412-2</a>	NO			"ROX5SSJ15R"			
<a href="#">1-2176412-4</a>	NO			"ROX5SSJ18R"			

Part Number	Part Discontinued per PCN	Customer Drawing	Customer Part Number	Alias Part Number(s)	Substitute Part Number	Substitute Alias Part Number(s)	Description Of Difference
<a href="#">1-2176412-5</a>	NO			"ROX5SSJ20R"			
<a href="#">1-2176412-6</a>	NO			"ROX5SSJ22R"			
<a href="#">1-2176412-7</a>	NO			"ROX5SSJ24R"			
<a href="#">1-2176412-8</a>	NO			"ROX5SSJ27R"			
<a href="#">1-2176412-9</a>	NO			"ROX5SSJ30R"			
<a href="#">1-2176414-5</a>	NO			"ROX7J75R"			
<a href="#">1-2176415-0</a>	NO			"ROX8J68R"			
<a href="#">1-2176415-1</a>	NO			"ROX8J75R"			
<a href="#">1625881-2</a>	NO			"ROX1G220R"			
<a href="#">1625881-3</a>	NO			"ROX1G270R"			
<a href="#">1625881-6</a>	NO			"ROX1G100R"			
<a href="#">1625885-6</a>	NO			"ROX1SJR22"			
<a href="#">1625885-7</a>	NO			"ROX1SJR33"			
<a href="#">1625886-2</a>	NO			"ROX1SJ330K", "ROX1SJ330KJIT"			
<a href="#">1625886-4</a>	NO			"ROX1SJ330R", "ROX1SJ330RJIT"			
<a href="#">1625886-5</a>	NO			"ROX1SJ33K", "ROX1SJ33KJIT"			
<a href="#">1625886-9</a>	NO			"ROX1SJ390R", "ROX1SJ390RJIT"			
<a href="#">1625887-2</a>	NO			"ROX2G82R"			
<a href="#">1625888-2</a>	NO			"ROX2J180R"			
<a href="#">1625889-7</a>	NO			"ROX2SG100K"			
<a href="#">1625890-2</a>	NO			"ROX2SJ100K"			
<a href="#">1625890-4</a>	NO			"ROX2SJ100R"			
<a href="#">1625890-5</a>	NO			"ROX2SJ10K"			
<a href="#">1625890-6</a>	NO			"ROX2SJ10R"			
<a href="#">1625890-7</a>	NO			"ROX2SJ120K"			
<a href="#">1625890-8</a>	NO			"ROX2SJ120R"			
<a href="#">1625890-9</a>	NO			"ROX2SJ12K"			
<a href="#">1625892-1</a>	NO			"ROX3SJR10"			
<a href="#">1625892-2</a>	NO			"ROX3SJR22"			

Part Number	Part Discontinued per PCN	Customer Drawing	Customer Part Number	Alias Part Number(s)	Substitute Part Number	Substitute Alias Part Number(s)	Description Of Difference
<a href="#">1625892-4</a>	NO			"ROX3SJR33"			
<a href="#">1625892-5</a>	NO			"ROX3SJR47"			
<a href="#">1625892-6</a>	NO			"ROX3SJR51"			
<a href="#">1625892-8</a>	NO			"ROX3SJ100K"			
<a href="#">1625892-9</a>	NO			"ROX3SJ100R"			
<a href="#">1625893-2</a>	NO			"ROX5SJ39K"			
<a href="#">1625893-4</a>	NO			"ROX5SJ22R"			
<a href="#">1625893-5</a>	NO			"ROX5SJ47K"			
<a href="#">1625893-6</a>	NO			"ROX5SJ150K"			
<a href="#">1625893-7</a>	NO			"ROX5SJ82K"			
<a href="#">1625893-8</a>	NO			"ROX5SJ91K"			
<a href="#">1625893-9</a>	NO			"ROX5SJ100K"			
<a href="#">1879072-7</a>	NO			"ROX3SF390R", "ROX3SG390R"			
<a href="#">2-1625885-3</a>	NO			"ROX1SJ150R", "ROX1SJ150RJIT"			
<a href="#">2-1625885-4</a>	NO			"ROX1SJ15K", "ROX1SJ15KJIT"			
<a href="#">2-1625885-5</a>	NO			"ROX1SJ15R", "ROX1SJ15RJIT"			
<a href="#">2-1625885-6</a>	NO			"ROX1SJ180K", "ROX1SJ180KJIT"			
<a href="#">2-1625885-7</a>	NO			"ROX1SJ180R", "ROX1SJ180RJIT"			
<a href="#">2-1625885-8</a>	NO			"ROX1SJ18K", "ROX1SJ18KJIT"			
<a href="#">2-1625886-0</a>	NO			"ROX1SJ47R", "ROX1SJ47RJIT"			
<a href="#">2-1625886-1</a>	NO			"ROX1SJ4K7", "ROX1SJ4K7JIT"			
<a href="#">2-1625886-2</a>	NO			"ROX1SJ4R7", "ROX1SJ4R7JIT"			
<a href="#">2-1625886-3</a>	NO			"ROX1SJ560K"			
<a href="#">2-1625886-4</a>	NO			"ROX1SJ560R", "ROX1SJ560RJIT"			
<a href="#">2-1625886-5</a>	NO			"ROX1SJ56K", "ROX1SJ56KJIT"			
<a href="#">2-1625886-6</a>	NO			"ROX1SJ56R", "ROX1SJ56RJIT"			
<a href="#">2-1625886-9</a>	NO			"ROX1SJ5K6", "ROX1SJ5K6JIT"			

Part Number	Part Discontinued per PCN	Customer Drawing	Customer Part Number	Alias Part Number(s)	Substitute Part Number	Substitute Alias Part Number(s)	Description Of Difference
<a href="#">2-1625890-0</a>	NO			"ROX2SJ1K0"			
<a href="#">2-1625890-1</a>	NO			"ROX2SJ1K2"			
<a href="#">2-1625890-3</a>	NO			"ROX2SJ1K5"			
<a href="#">2-1625890-4</a>	NO			"ROX2SJ1K8"			
<a href="#">2-1625890-6</a>	NO			"ROX2SJ1M0"			
<a href="#">2-1625890-9</a>	NO			"ROX2SJ1R8"			
<a href="#">2-1625892-0</a>	NO			"ROX3SJ18R"			
<a href="#">2-1625892-1</a>	NO			"ROX3SJ1K0"			
<a href="#">2-1625892-2</a>	NO			"ROX3SJ1K2"			
<a href="#">2-1625892-3</a>	NO			"ROX3SJ1K5"			
<a href="#">2-1625892-4</a>	NO			"ROX3SJ1K8"			
<a href="#">2-1625892-5</a>	NO			"ROX3SJ1M0"			
<a href="#">2-1625892-6</a>	NO			"ROX3SJ1R0"			
<a href="#">2-1625892-7</a>	NO			"ROX3SJ1R8"			
<a href="#">2-1625892-8</a>	NO			"ROX3SJ20K"			
<a href="#">2-2176412-0</a>	NO			"ROX5SSJ33R"			
<a href="#">2-2176412-2</a>	NO			"ROX5SSJ39R"			
<a href="#">2-2176412-4</a>	NO			"ROX5SSJ47R"			
<a href="#">2-2176412-5</a>	NO			"ROX5SSJ51R"			
<a href="#">2-2176412-6</a>	NO			"ROX5SSJ56R"			
<a href="#">2-2176412-7</a>	NO			"ROX5SSJ62R"			
<a href="#">2-2176412-8</a>	NO			"ROX5SSJ68R"			

Part Number	Part Discontinued per PCN	Customer Drawing	Customer Part Number	Alias Part Number(s)	Substitute Part Number	Substitute Alias Part Number(s)	Description Of Difference
<a href="#">2-2176412-9</a>	NO			"ROX5SSJ75R"			
<a href="#">2-2176414-7</a>	NO			"ROX7J240R"			
<a href="#">2-2176415-3</a>	NO			"ROX8J240R"			
<a href="#">2-2176416-1</a>	NO			"ROX9J360R"			
<a href="#">2176412-1</a>	NO			"ROX5SSJ5R1"			
<a href="#">2176412-2</a>	NO			"ROX5SSJ5R6"			
<a href="#">2176412-3</a>	NO			"ROX5SSJ6R2"			
<a href="#">2176412-4</a>	NO			"ROX5SSJ6R8"			
<a href="#">2176412-6</a>	NO			"ROX5SSJ8R2"			
<a href="#">2176412-8</a>	NO			"ROX5SSJ10R"			
<a href="#">2176412-9</a>	NO			"ROX5SSJ11R"			
<a href="#">2176413-1</a>	NO			"ROX5SSJ68K"			
<a href="#">2176413-2</a>	NO			"ROX5SSJ75K"			
<a href="#">2176413-3</a>	NO			"ROX5SSJ82K"			
<a href="#">2176413-5</a>	NO			"ROX5SSJ100K"			
<a href="#">3-1625885-0</a>	NO			"ROX1SJ18R"			
<a href="#">3-1625885-1</a>	NO			"ROX1SJ1K0", "ROX1SJ1K0JIT"			
<a href="#">3-1625885-2</a>	NO			"ROX1SJ1K2", "ROX1SJ1K2JIT"			
<a href="#">3-1625885-4</a>	NO			"ROX1SJ1K5", "ROX1SJ1K5JIT"			
<a href="#">3-1625885-5</a>	NO			"ROX1SJ1K8", "ROX1SJ1K8JIT"			
<a href="#">3-1625885-6</a>	NO			"ROX1SJ1M0", "ROX1SJ1M0JIT"			
<a href="#">3-1625885-8</a>	NO			"ROX1SJ1R0", "ROX1SJ1R0JIT"			
<a href="#">3-1625886-0</a>	NO			"ROX1SJ5R6", "ROX1SJ5R6JIT"			
<a href="#">3-1625886-3</a>	NO			"ROX1SJ680R", "ROX1SJ680RJIT"			
<a href="#">3-1625886-6</a>	NO			"ROX1SJ68R", "ROX1SJ68RJIT"			
<a href="#">3-1625890-0</a>	NO			"ROX2SJ220K"			

Part Number	Part Discontinued per PCN	Customer Drawing	Customer Part Number	Alias Part Number(s)	Substitute Part Number	Substitute Alias Part Number(s)	Description Of Difference
<a href="#">3-1625890-1</a>	NO			"ROX2SJ220R"			
<a href="#">3-1625890-2</a>	NO			"ROX2SJ22K"			
<a href="#">3-1625890-3</a>	NO			"ROX2SJ22R"			
<a href="#">3-1625890-4</a>	NO			"ROX2SJ270K"			
<a href="#">3-1625890-5</a>	NO			"ROX2SJ270R"			
<a href="#">3-1625890-6</a>	NO			"ROX2SJ27K"			
<a href="#">3-1625892-0</a>	NO			"ROX3SJ220K"			
<a href="#">3-1625892-1</a>	NO			"ROX3SJ220R"			
<a href="#">3-1625892-2</a>	NO			"ROX3SJ22K"			
<a href="#">3-1625892-3</a>	NO			"ROX3SJ22R"			
<a href="#">3-1625892-4</a>	NO			"ROX3SJ270R"			
<a href="#">3-1625892-5</a>	NO			"ROX3SJ27K"			
<a href="#">3-1625892-6</a>	NO			"ROX3SJ27R"			
<a href="#">3-1625892-7</a>	NO			"ROX3SJ2K2"			
<a href="#">3-1625892-8</a>	NO			"ROX3SJ2K7"			
<a href="#">3-1625892-9</a>	NO			"ROX3SJ2R2"			
<a href="#">3-1676123-5</a>	NO			"ROX05SJ22R"			
<a href="#">3-2176412-1</a>	NO			"ROX5SSJ91R"			
<a href="#">3-2176412-2</a>	NO			"ROX5SSJ100R"			
<a href="#">3-2176412-4</a>	NO			"ROX5SSJ120R"			
<a href="#">3-2176412-5</a>	NO			"ROX5SSJ130R"			
<a href="#">3-2176412-6</a>	NO			"ROX5SSJ150R"			

Part Number	Part Discontinued per PCN	Customer Drawing	Customer Part Number	Alias Part Number(s)	Substitute Part Number	Substitute Alias Part Number(s)	Description Of Difference
<a href="#">3-2176412-8</a>	NO			"ROX5SSJ180R"			
<a href="#">3-2176412-9</a>	NO			"ROX5SSJ200R"			
<a href="#">4-1625885-3</a>	NO			"ROX1SJ220K", "ROX1SJ220KJIT"			
<a href="#">4-1625885-4</a>	NO			"ROX1SJ220R", "ROX1SJ220RJIT"			
<a href="#">4-1625885-6</a>	NO			"ROX1SJ22K", "ROX1SJ22KJIT"			
<a href="#">4-1625885-7</a>	NO			"ROX1SJ22R", "ROX1SJ22RJIT"			
<a href="#">4-1625886-2</a>	NO			"ROX1SJ820R", "ROX1SJ820RJIT"			
<a href="#">4-1625886-4</a>	NO			"ROX1SJ82R"			
<a href="#">4-1625886-5</a>	NO			"ROX1SJ8K2"			
<a href="#">4-1625890-1</a>	NO			"ROX2SJ330R"			
<a href="#">4-1625890-2</a>	NO			"ROX2SJ33K"			
<a href="#">4-1625890-3</a>	NO			"ROX2SJ33R"			
<a href="#">4-1625890-5</a>	NO			"ROX2SJ39K"			
<a href="#">4-1625890-7</a>	NO			"ROX2SJ3K3"			
<a href="#">4-1625890-8</a>	NO			"ROX2SJ3K9"			
<a href="#">4-1625892-1</a>	NO			"ROX3SJ330R"			
<a href="#">4-1625892-2</a>	NO			"ROX3SJ33K"			
<a href="#">4-1625892-3</a>	NO			"ROX3SJ33R"			
<a href="#">4-1625892-4</a>	NO			"ROX3SJ390R"			
<a href="#">4-1625892-5</a>	NO			"ROX3SJ39K"			
<a href="#">4-1625892-7</a>	NO			"ROX3SJ3K3"			
<a href="#">4-1625892-8</a>	NO			"ROX3SJ3K9"			

Part Number	Part Discontinued per PCN	Customer Drawing	Customer Part Number	Alias Part Number(s)	Substitute Part Number	Substitute Alias Part Number(s)	Description Of Difference
<a href="#">4-1625892-9</a>	NO			"ROX3SJ3R3"			
<a href="#">4-2176412-0</a>	NO			"ROX5SSJ220R"			
<a href="#">4-2176412-1</a>	NO			"ROX5SSJ240R"			
<a href="#">4-2176412-2</a>	NO			"ROX5SSJ270R"			
<a href="#">4-2176412-3</a>	NO			"ROX5SSJ300R"			
<a href="#">4-2176412-4</a>	NO			"ROX5SSJ330R"			
<a href="#">4-2176412-6</a>	NO			"ROX5SSJ390R"			
<a href="#">4-2176412-8</a>	NO			"ROX5SSJ470R"			
<a href="#">4-2176412-9</a>	NO			"ROX5SSJ510R"			
<a href="#">5-1625885-1</a>	NO			"ROX1SJ27K", "ROX1SJ27KJIT"			
<a href="#">5-1625885-2</a>	NO			"ROX1SJ27R", "ROX1SJ27RJIT"			
<a href="#">5-1625885-3</a>	NO			"ROX1SJ2K2", "ROX1SJ2K2JIT"			
<a href="#">5-1625885-4</a>	NO			"ROX1SJ2K7", "ROX1SJ2K7JIT"			
<a href="#">5-1625885-5</a>	NO			"ROX1SJ2R2", "ROX1SJ2R2JIT"			
<a href="#">5-1625885-6</a>	NO			"ROX1SJ2R7", "ROX1SJ2R7JIT"			
<a href="#">5-1625885-7</a>	NO			"ROX1SJ82K"			
<a href="#">5-1625890-0</a>	NO			"ROX2SJ470K"			
<a href="#">5-1625890-1</a>	NO			"ROX2SJ470R"			
<a href="#">5-1625890-2</a>	NO			"ROX2SJ47K"			
<a href="#">5-1625890-3</a>	NO			"ROX2SJ47R"			
<a href="#">5-1625890-4</a>	NO			"ROX2SJ4K7"			
<a href="#">5-1625890-5</a>	NO			"ROX2SJ4R7"			



Part Number	Part Discontinued per PCN	Customer Drawing	Customer Part Number	Alias Part Number(s)	Substitute Part Number	Substitute Alias Part Number(s)	Description Of Difference
<a href="#">5-1625892-1</a>	NO			"ROX3SJ470K"			
<a href="#">5-1625892-2</a>	NO			"ROX3SJ470R"			
<a href="#">5-1625892-3</a>	NO			"ROX3SJ47K"			
<a href="#">5-1625892-4</a>	NO			"ROX3SJ47R"			
<a href="#">5-1625892-5</a>	NO			"ROX3SJ4K7"			
<a href="#">5-1625892-6</a>	NO			"ROX3SJ4R7"			
<a href="#">5-1625892-8</a>	NO			"ROX3SJ560R"			
<a href="#">5-1625892-9</a>	NO			"ROX3SJ56K"			
<a href="#">5-1676123-1</a>	NO			"ROX05SJ100R"			
<a href="#">5-1676123-3</a>	NO			"ROX05SJ120R"			
<a href="#">5-2176412-0</a>	NO			"ROX5SSJ560R"			
<a href="#">5-2176412-1</a>	NO			"ROX5SSJ620R"			
<a href="#">5-2176412-2</a>	NO			"ROX5SSJ680R"			
<a href="#">5-2176412-3</a>	NO			"ROX5SSJ750R"			
<a href="#">5-2176412-4</a>	NO			"ROX5SSJ820R"			
<a href="#">5-2176412-5</a>	NO			"ROX5SSJ910R"			
<a href="#">5-2176412-6</a>	NO			"ROX5SSJ1K0"			
<a href="#">5-2176412-8</a>	NO			"ROX5SSJ1K2"			
<a href="#">5-2176414-4</a>	NO			"ROX7J3K3"			
<a href="#">5-2176414-8</a>	NO			"ROX7J4K7"			
<a href="#">6-1625890-0</a>	NO			"ROX2SJ56K"			
<a href="#">6-1625890-1</a>	NO			"ROX2SJ56R"			

Part Number	Part Discontinued per PCN	Customer Drawing	Customer Part Number	Alias Part Number(s)	Substitute Part Number	Substitute Alias Part Number(s)	Description Of Difference
<a href="#">6-1625890-3</a>	NO			"ROX2SJ5R6"			
<a href="#">6-1625890-4</a>	NO			"ROX2SJ680R"			
<a href="#">6-1625890-5</a>	NO			"ROX2SJ68K"			
<a href="#">6-1625890-7</a>	NO			"ROX2SJ6K8"			
<a href="#">6-1625890-8</a>	NO			"ROX2SJ6R8"			
<a href="#">6-1625890-9</a>	NO			"ROX2SJ820R"			
<a href="#">6-1625892-0</a>	NO			"ROX3SJ56R"			
<a href="#">6-1625892-1</a>	NO			"ROX3SJ5K6"			
<a href="#">6-1625892-4</a>	NO			"ROX3SJ680R"			
<a href="#">6-1625892-6</a>	NO			"ROX3SJ68K"			
<a href="#">6-1625892-7</a>	NO			"ROX3SJ68R"			
<a href="#">6-1625892-8</a>	NO			"ROX3SJ6K8"			
<a href="#">6-1676123-2</a>	NO			"ROX05SJ300R"			
<a href="#">6-1676123-3</a>	NO			"ROX05SJ330R"			
<a href="#">6-1676123-7</a>	NO			"ROX05SJ470R"			
<a href="#">6-2176412-2</a>	NO			"ROX5SSJ1K8"			
<a href="#">6-2176412-4</a>	NO			"ROX5SSJ2K2"			
<a href="#">6-2176412-5</a>	NO			"ROX5SSJ2K4"			
<a href="#">6-2176412-9</a>	NO			"ROX5SSJ3K6"			
<a href="#">6-2176414-2</a>	NO			"ROX7J6K8"			
<a href="#">6-2176414-4</a>	NO			"ROX7J8K2"			
<a href="#">6-2176416-6</a>	NO			"ROX9J27K"			

Part Number	Part Discontinued per PCN	Customer Drawing	Customer Part Number	Alias Part Number(s)	Substitute Part Number	Substitute Alias Part Number(s)	Description Of Difference
<a href="#">Z-1625890-0</a>	NO			"ROX2SJ82K"			
<a href="#">Z-1625890-1</a>	NO			"ROX2SJ82R"			
<a href="#">Z-1625890-2</a>	NO			"ROX2SJ8K2"			
<a href="#">Z-1625890-3</a>	NO			"ROX2SJ8R2"			
<a href="#">Z-1625890-4</a>	NO			"ROX2SJ2K7"			
<a href="#">Z-1625890-6</a>	NO			"ROX2SJR47"			
<a href="#">Z-1625890-7</a>	NO			"ROX2SJ330K"			
<a href="#">Z-1625892-0</a>	NO			"ROX3SJ6R8"			
<a href="#">Z-1625892-1</a>	NO			"ROX3SJ820R"			
<a href="#">Z-1625892-2</a>	NO			"ROX3SJ82K"			
<a href="#">Z-1625892-3</a>	NO			"ROX3SJ82R"			
<a href="#">Z-1625892-5</a>	NO			"ROX3SJ120R"			
<a href="#">Z-1625892-6</a>	NO			"ROX3SJ8K2"			
<a href="#">Z-1625892-7</a>	NO			"ROX3SJ18K"			
<a href="#">Z-1676123-1</a>	NO			"ROX05SJ680R"			
<a href="#">Z-1676123-2</a>	NO			"ROX05SJ750R"			
<a href="#">Z-1676123-7</a>	NO			"ROX05SJ1K2"			
<a href="#">Z-2176412-0</a>	NO			"ROX5SSJ3K9"			
<a href="#">Z-2176412-1</a>	NO			"ROX5SSJ4K3"			
<a href="#">Z-2176412-2</a>	NO			"ROX5SSJ4K7"			
<a href="#">Z-2176412-3</a>	NO			"ROX5SSJ5K1"			
<a href="#">Z-2176412-4</a>	NO			"ROX5SSJ5K6"			

Part Number	Part Discontinued per PCN	Customer Drawing	Customer Part Number	Alias Part Number(s)	Substitute Part Number	Substitute Alias Part Number(s)	Description Of Difference
<a href="#">7-2176412-6</a>	NO			"ROX5SSJ6K8"			
<a href="#">7-2176412-7</a>	NO			"ROX5SSJ7K5"			
<a href="#">7-2176414-8</a>	NO			"ROX7J33K"			
<a href="#">7-2176415-4</a>	NO			"ROX8J33K"			
<a href="#">7-2176415-5</a>	NO			"ROX8J36K"			
<a href="#">8-1625890-1</a>	NO			"ROX2SJ3R3"			
<a href="#">8-1625890-3</a>	NO			"ROX2SJ680K"			
<a href="#">8-1625890-5</a>	NO			"ROX2SJ200K"			
<a href="#">8-1625890-9</a>	NO			"ROX2SJ2R0"			
<a href="#">8-1625892-0</a>	NO			"ROX3SJ1R2"			
<a href="#">8-1625892-1</a>	NO			"ROX3SJ1R5"			
<a href="#">8-1625892-2</a>	NO			"ROX3SJ270K"			
<a href="#">8-1625892-3</a>	NO			"ROX3SJ330K"			
<a href="#">8-1625892-6</a>	NO			"ROX3SJ5R6"			
<a href="#">8-2176412-0</a>	NO			"ROX5SSJ10K"			
<a href="#">8-2176412-1</a>	NO			"ROX5SSJ11K"			
<a href="#">8-2176412-2</a>	NO			"ROX5SSJ12K"			
<a href="#">8-2176412-3</a>	NO			"ROX5SSJ13K"			
<a href="#">8-2176412-4</a>	NO			"ROX5SSJ15K"			
<a href="#">8-2176412-5</a>	NO			"ROX5SSJ16K"			
<a href="#">8-2176412-6</a>	NO			"ROX5SSJ18K"			
<a href="#">8-2176412-7</a>	NO			"ROX5SSJ20K"			

Part Number	Part Discontinued per PCN	Customer Drawing	Customer Part Number	Alias Part Number(s)	Substitute Part Number	Substitute Alias Part Number(s)	Description Of Difference
<a href="#">8-2176412-8</a>	NO			"ROX5SSJ22K"			
<a href="#">8-2176412-9</a>	NO			"ROX5SSJ24K"			
<a href="#">8-2176416-2</a>	NO			"ROX9J120K"			
<a href="#">9-1625890-1</a>	NO			"ROX2SG100R"			
<a href="#">9-1625890-2</a>	NO			"ROX2SJ62K"			
<a href="#">9-1625892-1</a>	NO			"ROX3SJ120K"			
<a href="#">9-1625892-2</a>	NO			"ROX3SJ2R7"			
<a href="#">9-1625892-3</a>	NO			"ROX3SJR15"			
<a href="#">9-1625892-9</a>	NO			"ROX3SJ36K"			
<a href="#">9-1676123-1</a>	NO			"ROX05SJ4K7"			
<a href="#">9-1676123-3</a>	NO			"ROX05SJ5K6"			
<a href="#">9-1676123-4</a>	NO			"ROX05SJ6K2"			
<a href="#">9-1676123-9</a>	NO			"ROX05SJ10K"			
<a href="#">9-2176412-0</a>	NO			"ROX5SSJ27K"			
<a href="#">9-2176412-1</a>	NO			"ROX5SSJ30K"			
<a href="#">9-2176412-2</a>	NO			"ROX5SSJ33K"			
<a href="#">9-2176412-4</a>	NO			"ROX5SSJ39K"			
<a href="#">9-2176412-6</a>	NO			"ROX5SSJ47K"			
<a href="#">9-2176412-7</a>	NO			"ROX5SSJ51K"			
<a href="#">9-2176412-8</a>	NO			"ROX5SSJ56K"			
<a href="#">9-2176412-9</a>	NO			"ROX5SSJ62K"			
<a href="#">9-2176414-0</a>	NO			"ROX7J100K"			

Part Number	Part Discontinued per PCN	Customer Drawing	Customer Part Number	Alias Part Number(s)	Substitute Part Number	Substitute Alias Part Number(s)	Description Of Difference
<a href="#">9-2176414-4</a>	NO			"ROX7J150K"			

The documents listed below are being modified. Related parts that are not explicitly listed on this PCN are not being modified or discontinued as per the PCN. The Last Order Date, Last Ship Date, First Date to Ship Changed Parts and last date for Mixed Shipments apply only to parts explicitly listed on this PCN.

**Document(s) Being Modified:**

Documents Number	Related Part Number	Customer Part Number	Current Revision	New Revision
<a href="#">1773271</a>	1-1625885-1		J	

**Key Features**

**High Power with Small Size for Space Saving**

**Excellent Long Term Stability**

**Complete Flameproof Construction**

**Controlled Temperature Capability**

**Solvent Resistant Coat and Code**

**Special Lead Formations Possible**

**Type ROX Series**



The resistive element comprises a metal oxide film deposited on a ceramic former. The element is protected by a flameproof coating which will withstand overload conditions without flame or mechanical damage. They are recommended for use in applications such as line protection etc

**Characteristics – Electrical**

Type	Rated Power @ 70°C	Max. Working Voltage	Max. Overload Voltage	Dielectric Withstand Voltage	Resistance Range Ω	Operating Temp. Range
Normal Size	ROX025	0.25W	250V	400V	250V	0.3 ~ 50K
	ROX05	0.5W	250V	400V	250V	0.3 ~ 330K
	ROX1	1W	350V	600V	350V	0.1 ~ 470K
	ROX2	2W	350V	600V	350V	0.1 ~ 560K
	ROX3	3W	500V	800V	500V	5.0 ~ 100K
	ROX5	5W	750V	1000V	750V	5.0 ~ 150K
	ROX7	7W	750V	1000V	750V	20 ~ 150K
	ROX8	8W	750V	1000V	750V	30 ~ 200K
	ROX9	9W	750V	1000V	750V	50 ~ 200K
Small Size	ROX05S	0.5W	250V	400V	250V	0.3 ~ 50K
	ROX1S	1W	350V	600V	350V	0.3 ~ 1M0
	ROX2S	2W	350V	600V	350V	0.3 ~ 1M0
	ROX3S	3W	350V	600V	350V	0.3 ~ 1M0
	ROX4S	4W	500V	800V	500V	5.0 ~ 100K
	ROX5SS	5W	500V	800V	500V	5.0 ~ 100K
	ROX5S	5W	500V	800V	500V	5.0 ~ 150K

Resistors shall have a rated direct-current (DC) continuous working voltage or an approximate sine-wave root-mean-square (RMS) alternating-current (AC) continuous working voltage at commercial line frequency and waveform corresponding to the power rating , as determined from the following formula :

$$RCWV = \sqrt{P \times R}$$

Where : RCWV = Rated DC or RMS AC continuous working voltage at commercial-line frequency and waveform (volt)

P = Power Rating (watt)

R = Nominal Resistance (ohm)

Rated Voltage = RCWV or Max. Working Voltage, whichever is smaller



### Environmental Characteristics

Characteristics	Specification	Test Methods ( JIS C 5201-1 )	
DC. Resistance	Must be within the specified tolerance	5.1 The limit of error of measuring apparatus shall not exceed allowable range or 5% of resistance tolerance	
Temperature Coefficient	Range $\Omega$	5.2 Natural resistance change per temp. degree centigrade.  $\frac{R_2 - R_1}{R_1(t_2 - t_1)} \times 10^6 \text{ (PPM/}^\circ\text{C)}$ R <sub>1</sub> : Resistance value at room temperature (t <sub>1</sub> ) R <sub>2</sub> : Resistance value at room temp. plus 100 °C (t <sub>2</sub> )	
	0.1 $\Omega$ ~ 12 $\Omega$		$\pm 200$
	12.1 $\Omega$ ~ 100K		$\pm 350$
	101K ~ 1M		-700
	1.1M ~ 10M		-1500
Short time overload	Resistance change rate is Normal Size : $\pm (1\% + 0.05\Omega)$ Max. Small Size : $\pm (2\% + 0.05\Omega)$ Max. with no evidence of mechanical damage	5.5 Permanent resistance change after the application of a potential of 2.5 times RCWV or the max. overload voltage respectively specified in the above list, whichever less for 5 seconds	
Dielectric Withstanding Voltage	No evidence of flashover mechanical damage, arcing or insulation break down	5.7 Resistors shall be clamped in the trough of a 90° metallic V-block and shall be tested at AC potential respectively specified in the electrical characteristics table for 60 + 10/ -0 seconds	
Terminal Strength	No Evidence of mechanical damage	6.1 <b>Direct load:</b> Resistance to a 2.5 kgs direct load for 10 secs. in the direction of the longitudinal axis of the terminal leads <b>Twist test:</b> Terminal leads shall be bent through 90 ° at point of about 6mm from the body of the resistor and shall be rotated through 360° about the original axis of the bent terminal in alternating direction for a total of 3 rotations.	
Resistance to soldering heat	Resistance change rate is: $\pm (1\% + 0.05\Omega)$ Max. with no evidence of mechanical damage	6.4 Permanent resistance change when leads immersed to 3.2 mm to 4.8 mm from the body in 350°C $\pm$ 10 °C solder for 3 $\pm$ 0.5 seconds	
Solderability	95 % coverage Min.	6.5 The area covered with a new , smooth, clean , shiny and continuous surface free from concentrated pinholes. Test temp. of solder: 245°C $\pm$ 3°C Dwell time in solder : 2 ~ 3 seconds	





### Environmental Characteristics (continued)

Characteristics	Specification	Test Methods ( JIS C 5201-1 )															
Resistance to Solvent	No deterioration of protective coatings and marking	6.9 Specimens shall be immersed in a bath of trichroethane completely for 3 minutes with ultrasonic															
Temperature cycling	Resistance change rate is: $\pm (2\% + 0.05\Omega)$ Max. with no evidence of mechanical damage	7.4 Resistance change after continuous 5 cycles for duty shown below:															
		<table border="1"> <thead> <tr> <th>Step</th> <th>Step</th> <th>Step</th> </tr> </thead> <tbody> <tr> <td>1</td> <td>1</td> <td>1</td> </tr> <tr> <td>2</td> <td>2</td> <td>2</td> </tr> <tr> <td>3</td> <td>3</td> <td>3</td> </tr> <tr> <td>4</td> <td>4</td> <td>4</td> </tr> </tbody> </table>	Step	Step	Step	1	1	1	2	2	2	3	3	3	4	4	4
		Step	Step	Step													
		1	1	1													
		2	2	2													
3	3	3															
4	4	4															
Load life in humidity	<table border="1"> <thead> <tr> <th>Resistance Value</th> <th><math>\Delta R/R</math></th> </tr> </thead> <tbody> <tr> <td>Less than 100K<math>\Omega</math></td> <td><math>\pm 5\%</math></td> </tr> <tr> <td>100K<math>\Omega</math> or more</td> <td><math>\pm 10\%</math></td> </tr> </tbody> </table>	Resistance Value	$\Delta R/R$	Less than 100K $\Omega$	$\pm 5\%$	100K $\Omega$ or more	$\pm 10\%$	7.9 Resistance change after 1,000 hours operating at RCWV with duty cycle of (1.5 hours "on", 0.5 hour "off") in a humidity test chamber controlled at $40\text{ }^\circ\text{C} \pm 2\text{ }^\circ\text{C}$ and 90 to 95 % relative humidity									
		Resistance Value	$\Delta R/R$														
		Less than 100K $\Omega$	$\pm 5\%$														
		100K $\Omega$ or more	$\pm 10\%$														
Load life	<table border="1"> <thead> <tr> <th>Resistance Value</th> <th><math>\Delta R/R</math></th> </tr> </thead> <tbody> <tr> <td>Less than 100K<math>\Omega</math></td> <td><math>\pm 5\%</math></td> </tr> <tr> <td>100K<math>\Omega</math> or more</td> <td><math>\pm 10\%</math></td> </tr> </tbody> </table>	Resistance Value	$\Delta R/R$	Less than 100K $\Omega$	$\pm 5\%$	100K $\Omega$ or more	$\pm 10\%$	7.10 Permanent resistance change after 1,000 hours operating at RCWV with duty cycle of (1.5 hours "on", 0.5 hour "off") at $70\text{ }^\circ\text{C} \pm 2\text{ }^\circ\text{C}$ ambient									
		Resistance Value	$\Delta R/R$														
		Less than 100K $\Omega$	$\pm 5\%$														
		100K $\Omega$ or more	$\pm 10\%$														
Pulse overload	Resistance change rate is: Normal Size : $\pm (2\% + 0.05\Omega)$ Max. Small Size : $\pm (5\% + 0.05\Omega)$ Max. with no evidence of mechanical damage	5.8 Resistance change after 10,000 cycles (1 second "on", 25 seconds "off") at 4 times RCWV or the max. pulse overload voltage															

### Derating:

In ambient temperatures greater than  $70\text{ }^\circ\text{C}$  the load shall de-rate as shown in the graph below:

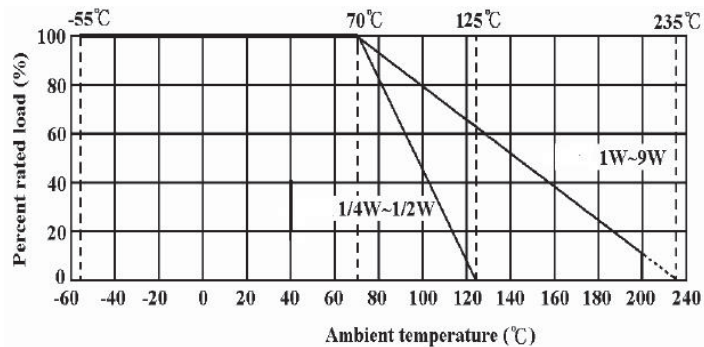

**Construction:**

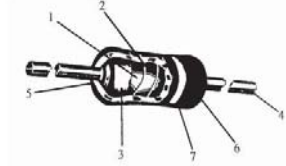

No.	Name	Material		
1	Basic Body	Rod Type Ceramics		
2	Resistance Film	0.1Ω ≤ R ≤ 12Ω : CNP film For All Wattage		
		12.1Ω ≤ R ≤ 100KΩ : Metal oxide film R > 100KΩ : Carbon film For 1/2W-S, 1/4W		
		12.1Ω ≤ R ≤ 120KΩ : Metal oxide film R > 120KΩ : Carbon film For 1/2W,1W-S		
		12.1Ω ≤ R ≤ 150KΩ : Metal oxide film R > 150KΩ : Carbon film For 1W,2W-S,2W,3W-S,3W,4W-S,5W-SS		
		12.1Ω ≤ R ≤ 180KΩ : Metal oxide film R > 180KΩ : Carbon film (For 5W,5W-S)		
		12.1Ω ≤ R ≤ 200KΩ : Metal oxide film (For 7W,8W,9W)		
		3	End Cap	Steel (Tin plated iron surface)
		4	Lead Wire	Annealed copper wire coated with tin
5	Joint	By welding		
6	Coating	Normal size --Insulated & Non-Flame Paint (Color : Gray ) Small size --Insulated & Non-Flame Paint (Color : Sea-Blue )		
7	Color Code	Non-Flame epoxy resin		

**Dimensions:**

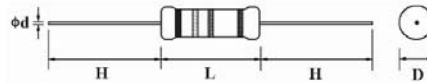

Type	Dimensions (MM)				
	D (max.)	L (max.)	d ±0.05	H ±3	
Normal Size	ROX025	2.5	7.5	0.54	28
	ROX05	3.5	10	0.70	28
	ROX1	5	12	0.70	25
	ROX2	5.5	16	0.70	28
	ROX3	6.5	17.5	0.75	28
	ROX5	8.5	26	0.75	38
	ROX7	8.5	32	0.75	38
	ROX8	8.5	41	0.75	38
	ROX9	8.5	54	0.75	38
Small Size	ROX05S	2.5	7.5	0.54	28
	ROX1S	3.5	10	0.70	28
	ROX2S	5	12	0.70	25
	ROX3S	5.5	16	0.70	28
	ROX4S	6.5	17.5	0.75	28
	ROX5SS	6.5	17.5	0.75	28
	ROX5S	8	25	0.75	38

### Painting method:

Welding point, terminal and lead wire, is permissible to be exposed without the outer coated cover. The extent should be within 1/2 of the resistor body diameter.

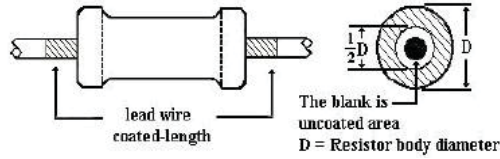

### Marking:

For 1/4W, 1/2W, 1W, 2W, 3W, 4W, 5W and all of small size Resistors shall be marked with color coding. colors shall be in accordance with JIS C 0802

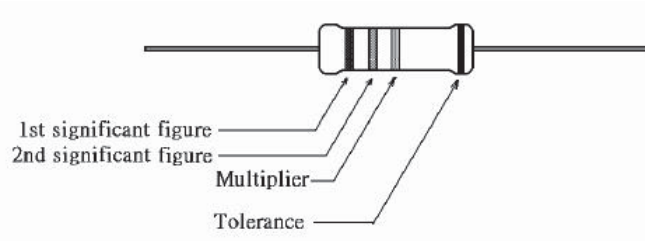

For 7W, 8W, 9W marking shall be in text format:

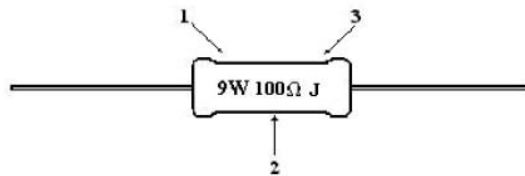

### Code description and regulation

1. Wattage rating.
2. Nominal resistance value.
3. Resistance Tolerance.

G: ± 2 %

J: ± 5 %

K: ± 10 %

### Packing Specification:

Taping:

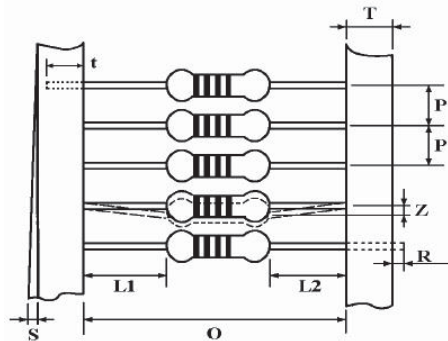

	Type	Style	O±1	P	L1-L2	T	Z	R	t	S
Normal Size	ROX025	PT-52	52	5±0.3	1 Max	6±1	1 Max	0	4±1	0.5 max
	ROX05	PT-52	52	5±0.3	1 Max	6±1	1 Max	0	4±1	0.5 max
	ROX1	PT-52	52	5±0.3	1 Max	6±1	1 Max	0	4±1	0.5 max
	ROX2	PT-64	64	10±0.5	1 Max	6±1	1 Max	0	5±1	0.5 max
Small Size	ROX3	PT-64	64	10±0.5	1 Max	6±1	1 Max	0	5±1	0.5 max
	ROX05S	PT-52	52	5±0.3	1 Max	6±1	1 Max	0	4±1	0.5 max
	ROX1S	PT-52	52	5±0.3	1 Max	6±1	1 Max	0	4±1	0.5 max
	ROX2S	PT-52	52	5±0.3	1 Max	6±1	1 Max	0	4±1	0.5 max
	ROX3S	PT-64	64	10±0.5	1 Max	6±1	1 Max	0	5±1	0.5 max
	ROX4S	PT-64	64	10±0.5	1 Max	6±1	1 Max	0	5±1	0.5 max
	ROX5SS	PT-64	64	10±0.5	1 Max	6±1	1 Max	0	5±1	0.5 max

Tape in box packing (Ammopack):

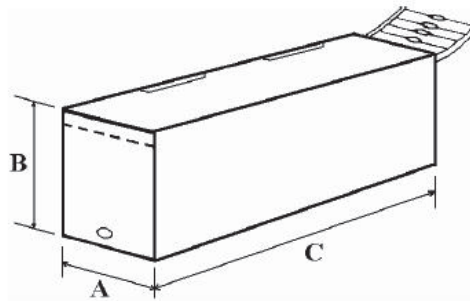

Type	C ± 5	A ± 5	B ± 5	Pack Quantity
ROX025	250	75	96	5000
ROX05	260	85	70	1000
ROX1	262	86	80	1000
ROX2	262	92	108	1000
ROX3	256	92	80	500
ROX05S	250	75	96	5000
ROX1S	260	85	70	1000
ROX2S	262	86	80	1000
ROX3S	262	92	108	1000
ROX4S	256	92	80	500
ROX5SS	256	92	80	500

NB Certain products can be supplied reeled on request.

Plastic cases in box:

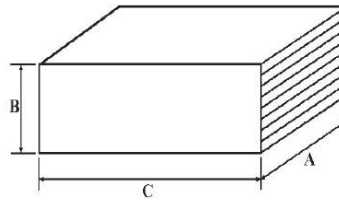

Type	C ±5	A ±5	B ±5	Quantity	
				Plastic Case	Box
ROX5S	36	20	8	100	1000
ROX5	36	20	8	100	1000

Bulk packaging (plastic bag in inner box):

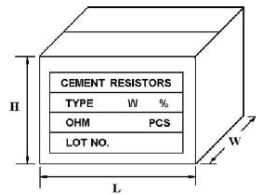

Inner Box of Plastic bag.

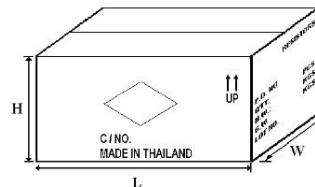

Carton Box

Type	Qty/Bag (Pcs)	Qty/Box (Pcs)	Qty/Carton Pcs	Box size LxWxH (±5)	Carton size LxWxH (±5)	Gross wt ±2 Kgs
ROX7	8	32	1600	150 x 75 x 33	432 x 308 x 215	9.5
ROX8	8	32	1600	150 x 75 x 33	432 x 308 x 215	11.5
ROX9	10	300	1800	200 x 171 x 113	520 x 215 x 250	15

### How To Order

Common Part	Power Rating		Tolerance	Resistance Value	Special Request
ROX – Flame proof power metal oxide film resistor	<b>Normal size</b>	<b>Small size</b>	G – 2% J – 5%	R33 - 0.33Ω 1R0 - 1Ω 10R - 10Ω 100R - 100Ω 1K0 - 1KΩ (1000Ω) 100K - 100KΩ (100,000Ω)	BL * – Pre-formed Leads  TR - Reeled
	025 - 1/4W	05S - 1/2W			
	05 - 1/2W	1S - 1W			
	1 - 1W	1S - 1W			
	2 - 2W	2S - 2W			
	3 - 3W	3S - 3W			
	5 - 5W	4S - 4W			
	7 - 7W	5SS - 5W			
	8 - 8W	5S - 5W			
	9 - 9W				

**Key Features**

**High Power with Small Size for Space Saving**

**Excellent Long Term Stability**

**Complete Flameproof Construction**

**Controlled Temperature Capability**

**Solvent Resistant Coat and Code**

**Special Lead Formations Possible**

**Type ROX Series**



The resistive element comprises a metal oxide film deposited on a ceramic former. The element is protected by a flameproof coating which will withstand overload conditions without flame or mechanical damage. They are recommended for use in applications such as line protection etc

**Characteristics – Electrical**

Type	Rated Power @ 70°C	Max. Working Voltage	Max. Overload Voltage	Dielectric Withstand Voltage	Resistance Range Ω	Operating Temp. Range	
Normal Size	ROX025	0.25W	250V	400V	250V	0.3 ~ 50K	-55~130°C
	ROX05	0.5W	250V	400V	250V	0.3 ~ 50K	
	ROX1	1W	350V	600V	350V	0.1 ~ 50K	
	ROX2	2W	350V	600V	350V	0.1 ~ 50K	-55~200°C
	ROX3	3W	500V	800V	500V	5.0 ~ 100K	
	ROX5	5W	750V	1000V	750V	5.0 ~ 150K	
	ROX7	7W	750V	1000V	750V	20 ~ 150K	
	ROX8	8W	750V	1000V	750V	30 ~ 200K	
ROX9	9W	750V	1000V	750V	50 ~ 200K		
Small Size	ROX05S	0.5W	250V	400V	250V	0.3 ~ 50K	-55~130°C
	ROX1S	1W	350V	600V	350V	0.3 ~ 1M0	-55~200°C
	ROX2S	2W	350V	600V	350V	0.3 ~ 1M0	
	ROX3S	3W	350V	600V	350V	0.3 ~ 1M0	
	ROX4S	4W	500V	800V	500V	5.0 ~ 100K	
	ROX5SS	5W	500V	800V	500V	5.0 ~ 100K	
	ROX5S	5W	500V	800V	500V	5.0 ~ 150K	

Resistors shall have a rated direct-current (DC) continuous working voltage or an approximate sine-wave root-mean-square (RMS) alternating-current (AC) continuous working voltage at commercial line frequency and waveform corresponding to the power rating , as determined from the following formula :

$$RCWV = \sqrt{P \times R}$$

Where : RCWV = Rated DC or RMS AC continuous working voltage at commercial-line frequency and waveform (volt)

P = Power Rating (watt)

R = Nominal Resistance (ohm)

Rated Voltage = RCWV or Max. Working Voltage, whichever is smaller



### Environmental Characteristics

Characteristics	Specification	Test Methods ( JIS C 5201-1 )	
DC. Resistance	Must be within the specified tolerance	5.1 The limit of error of measuring apparatus shall not exceed allowable range or 5% of resistance tolerance	
Temperature Coefficient	Range $\Omega$	5.2 Natural resistance change per temp. degree centigrade.  $\frac{R_2 - R_1}{R_1(t_2 - t_1)} \times 10^6 \text{ (PPM/}^\circ\text{C)}$ R <sub>1</sub> : Resistance value at room temperature (t <sub>1</sub> ) R <sub>2</sub> : Resistance value at room temp. plus 100 °C (t <sub>2</sub> )	
	0.1 $\Omega$ ~ 12 $\Omega$		$\pm 200$
	12.1 $\Omega$ ~ 100K		$\pm 350$
	101K ~ 1M		-700
	1.1M ~ 10M		-1500
Short time overload	Resistance change rate is Normal Size : $\pm (1\% + 0.05\Omega)$ Max. Small Size : $\pm (2\% + 0.05\Omega)$ Max. with no evidence of mechanical damage	5.5 Permanent resistance change after the application of a potential of 2.5 times RCWV or the max. overload voltage respectively specified in the above list, whichever less for 5 seconds	
Dielectric Withstanding Voltage	No evidence of flashover mechanical damage, arcing or insulation break down	5.7 Resistors shall be clamped in the trough of a 90° metallic V-block and shall be tested at AC potential respectively specified in the electrical characteristics table for 60 + 10/ -0 seconds	
Terminal Strength	No Evidence of mechanical damage	6.1 <b>Direct load:</b> Resistance to a 2.5 kgs direct load for 10 secs. in the direction of the longitudinal axis of the terminal leads <b>Twist test:</b> Terminal leads shall be bent through 90 ° at point of about 6mm from the body of the resistor and shall be rotated through 360° about the original axis of the bent terminal in alternating direction for a total of 3 rotations.	
Resistance to soldering heat	Resistance change rate is: $\pm (1\% + 0.05\Omega)$ Max. with no evidence of mechanical damage	6.4 Permanent resistance change when leads immersed to 3.2 mm to 4.8 mm from the body in 350°C $\pm$ 10 °C solder for 3 $\pm$ 0.5 seconds	
Solderability	95 % coverage Min.	6.5 The area covered with a new , smooth, clean , shiny and continuous surface free from concentrated pinholes. Test temp. of solder: 245°C $\pm$ 3°C Dwell time in solder : 2 ~ 3 seconds	

### Environmental Characteristics (continued)

Characteristics	Specification	Test Methods ( JIS C 5201-1 )															
Resistance to Solvent	No deterioration of protective coatings and marking	6.9 Specimens shall be immersed in a bath of trichroethane completely for 3 minutes with ultrasonic															
Temperature cycling	Resistance change rate is: ± (2% + 0.05Ω) Max. with no evidence of mechanical damage	7.4 Resistance change after continuous 5 cycles for duty shown below:															
		<table border="1"> <thead> <tr> <th>Step</th> <th>Temp.</th> <th>Time</th> </tr> </thead> <tbody> <tr> <td>1</td> <td>-55±3°C</td> <td>30 mins</td> </tr> <tr> <td>2</td> <td>Room Temp</td> <td>10~15 mins</td> </tr> <tr> <td>3</td> <td>155±2°C</td> <td>30 mins</td> </tr> <tr> <td>4</td> <td>Room Temp</td> <td>10~15 mins</td> </tr> </tbody> </table>	Step	Temp.	Time	1	-55±3°C	30 mins	2	Room Temp	10~15 mins	3	155±2°C	30 mins	4	Room Temp	10~15 mins
		Step	Temp.	Time													
		1	-55±3°C	30 mins													
		2	Room Temp	10~15 mins													
3	155±2°C	30 mins															
4	Room Temp	10~15 mins															
Load life in humidity	<table border="1"> <thead> <tr> <th>Resistance Value</th> <th>ΔR/R</th> </tr> </thead> <tbody> <tr> <td>Less than 100KΩ</td> <td>± 5 %</td> </tr> <tr> <td>100KΩ or more</td> <td>± 10 %</td> </tr> </tbody> </table>	Resistance Value	ΔR/R	Less than 100KΩ	± 5 %	100KΩ or more	± 10 %	7.9 Resistance change after 1,000 hours operating at RCWV with duty cycle of (1.5 hours "on", 0.5 hour "off") in a humidity test chamber controlled at 40 °C ± 2 °C and 90 to 95 % relative humidity									
		Resistance Value	ΔR/R														
		Less than 100KΩ	± 5 %														
		100KΩ or more	± 10 %														
Load life	<table border="1"> <thead> <tr> <th>Resistance Value</th> <th>ΔR/R</th> </tr> </thead> <tbody> <tr> <td>Less than 100KΩ</td> <td>± 5 %</td> </tr> <tr> <td>100KΩ or more</td> <td>± 10 %</td> </tr> </tbody> </table>	Resistance Value	ΔR/R	Less than 100KΩ	± 5 %	100KΩ or more	± 10 %	7.10 Permanent resistance change after 1,000 hours operating at RCWV with duty cycle of (1.5 hours "on", 0.5 hour "off") at 70°C ± 2°C ambient									
		Resistance Value	ΔR/R														
		Less than 100KΩ	± 5 %														
		100KΩ or more	± 10 %														
Pulse overload	Resistance change rate is: Normal Size : ± (2% + 0.05Ω) Max. Small Size : ± (5% + 0.05Ω) Max. with no evidence of mechanical damage	5.8 Resistance change after 10,000 cycles (1 second "on", 25 seconds "off") at 4 times RCWV or the max. pulse overload voltage															

### Derating:

In ambient temperatures greater than 70°C the load shall de-rate as shown in the graph below:

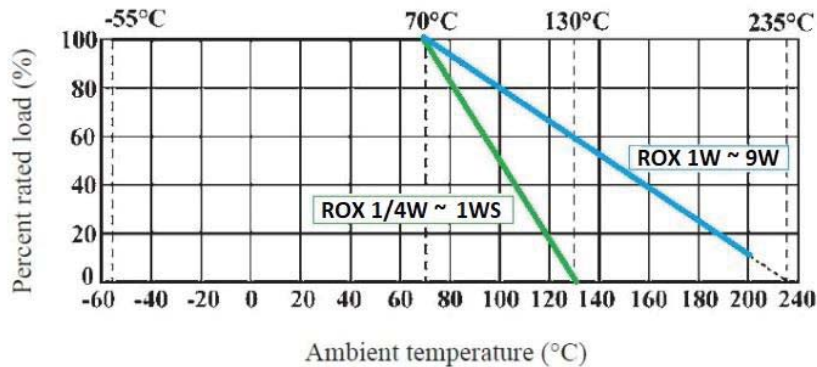



**Construction:**

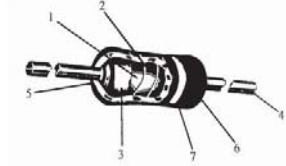

No.	Name	Material		
1	Basic Body	Rod Type Ceramics		
2	Resistance Film	0.1Ω ≤ R ≤ 12Ω : CNP film For All Wattage		
		12.1Ω ≤ R ≤ 100KΩ : Metal oxide film R > 100KΩ : Carbon film For 1/2W-S, 1/4W		
		12.1Ω ≤ R ≤ 120KΩ : Metal oxide film R > 120KΩ : Carbon film For 1/2W,1W-S		
		12.1Ω ≤ R ≤ 150KΩ : Metal oxide film R > 150KΩ : Carbon film For 1W,2W-S,2W,3W-S,3W,4W-S,5W-SS		
		12.1Ω ≤ R ≤ 180KΩ : Metal oxide film R > 180KΩ : Carbon film (For 5W,5W-S)		
		12.1Ω ≤ R ≤ 200KΩ : Metal oxide film (For 7W,8W,9W)		
		3	End Cap	Steel (Tin plated iron surface)
		4	Lead Wire	Annealed copper wire coated with tin
5	Joint	By welding		
6	Coating	Normal size --Insulated & Non-Flame Paint (Color : Gray ) Small size --Insulated & Non-Flame Paint (Color : Sea-Blue )		
7	Color Code	Non-Flame epoxy resin		

**Dimensions:**

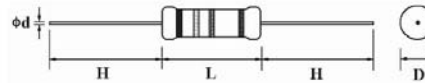

Type	Dimensions (MM)				
	D (max.)	L (max.)	d ±0.05	H ±3	
Normal Size	ROX025	2.5	7.5	0.54	28
	ROX05	3.5	10	0.70	28
	ROX1	5	12	0.70	25
	ROX2	5.5	16	0.70	28
	ROX3	6.5	17.5	0.75	28
	ROX5	8.5	26	0.75	38
	ROX7	8.5	32	0.75	38
	ROX8	8.5	41	0.75	38
	ROX9	8.5	54	0.75	38
Small Size	ROX05S	2.5	7.5	0.54	28
	ROX1S	3.5	10	0.70	28
	ROX2S	5	12	0.70	25
	ROX3S	5.5	16	0.70	28
	ROX4S	6.5	17.5	0.75	28
	ROX5SS	6.5	17.5	0.75	28
	ROX5S	8	25	0.75	38

### Painting method:

Welding point, terminal and lead wire, is permissible to be exposed without the outer coated cover. The extent should be within 1/2 of the resistor body diameter.

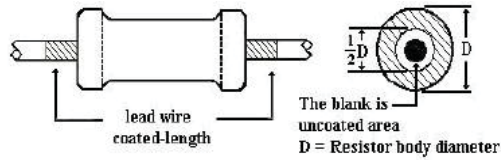

### Marking:

For 1/4W, 1/2W, 1W, 2W, 3W, 4W, 5W and all of small size Resistors shall be marked with color coding. colors shall be in accordance with JIS C 0802

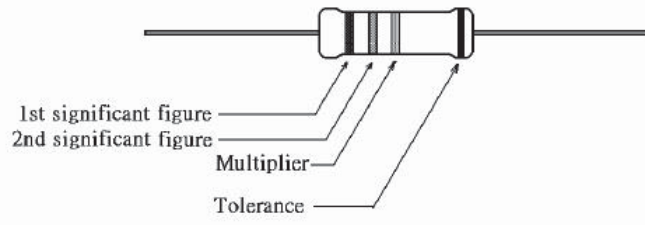

For 7W, 8W, 9W marking shall be in text format:

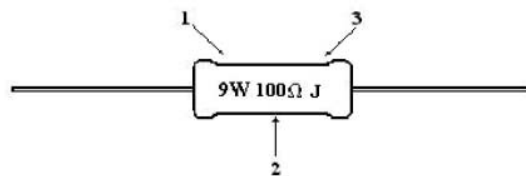

### Code description and regulation

1. Wattage rating.
2. Nominal resistance value.
3. Resistance Tolerance.

G: ± 2 %

J: ± 5 %

K: ± 10 %

### Packing Specification:

Taping:

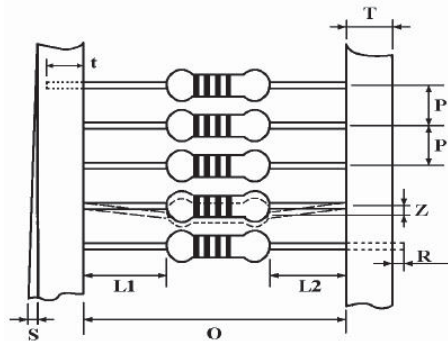

	Type	Style	O±1	P	L1-L2	T	Z	R	t	S
Normal Size	ROX025	PT-52	52	5±0.3	1 Max	6±1	1 Max	0	4±1	0.5 max
	ROX05	PT-52	52	5±0.3	1 Max	6±1	1 Max	0	4±1	0.5 max
	ROX1	PT-52	52	5±0.3	1 Max	6±1	1 Max	0	4±1	0.5 max
	ROX2	PT-64	64	10±0.5	1 Max	6±1	1 Max	0	5±1	0.5 max
	ROX3	PT-64	64	10±0.5	1 Max	6±1	1 Max	0	5±1	0.5 max
Small Size	ROX05S	PT-52	52	5±0.3	1 Max	6±1	1 Max	0	4±1	0.5 max
	ROX1S	PT-52	52	5±0.3	1 Max	6±1	1 Max	0	4±1	0.5 max
	ROX2S	PT-52	52	5±0.3	1 Max	6±1	1 Max	0	4±1	0.5 max
	ROX3S	PT-64	64	10±0.5	1 Max	6±1	1 Max	0	5±1	0.5 max
	ROX4S	PT-64	64	10±0.5	1 Max	6±1	1 Max	0	5±1	0.5 max
	ROX5SS	PT-64	64	10±0.5	1 Max	6±1	1 Max	0	5±1	0.5 max

Tape in box packing (Ammopack):

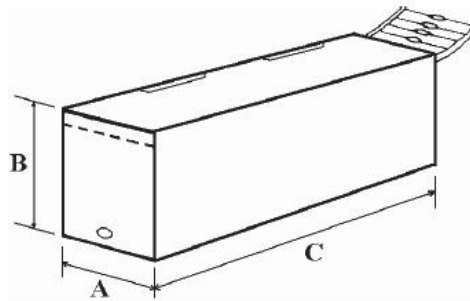

Type	C ± 5	A ± 5	B ± 5	Pack Quantity
ROX025	250	75	96	5000
ROX05	260	85	70	1000
ROX1	262	86	80	1000
ROX2	262	92	108	1000
ROX3	256	92	80	500
ROX05S	250	75	96	5000
ROX1S	260	85	70	1000
ROX2S	262	86	80	1000
ROX3S	262	92	108	1000
ROX4S	256	92	80	500
ROX5SS	256	92	80	500

NB Certain products can be supplied reeled on request.

**Plastic cases in box:**

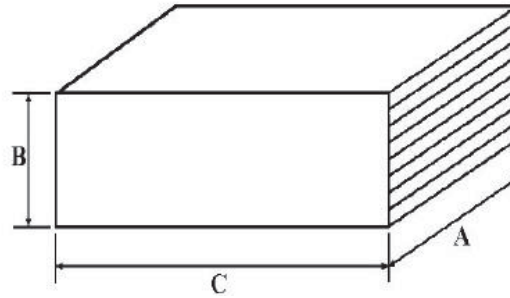

Type	C ±5	A ±5	B ±5	Quantity	
				Plastic Case	Box
ROX5S	36	20	8	100	1000
ROX5	36	20	8	100	1000

**Bulk packaging (plastic bag in inner box):**

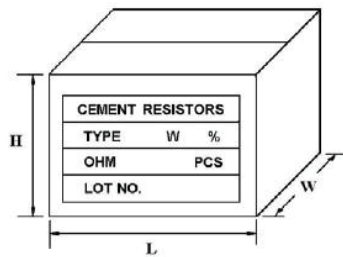

Inner Box of Plastic bag.

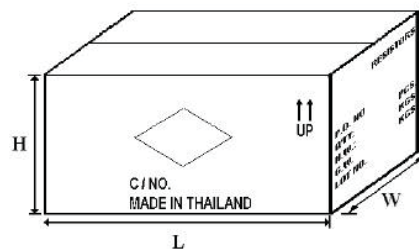

Carton Box

Type	Qty/Bag (Pcs)	Qty/Box (Pcs)	Qty/Carton Pcs	Box size LxWxH (±5)	Carton size LxWxH (±5)	Gross wt ±2 Kgs
ROX7	8	32	1600	150 x 75 x 33	432 x 308 x 215	9.5
ROX8	8	32	1600	150 x 75 x 33	432 x 308 x 215	11.5
ROX9	10	300	1800	200 x 171 x 113	520 x 215 x 250	15



## Environment Related Substance

This product complies to EU RoHS directive, EU PAHs directive, EU PFOS directive and Halogen free Ozone layer depleting substances.

Ozone depleting substances are not used in our manufacturing process of this product. This product is not manufactured using Chloro fluorocarbons (CFCs), Hydrochlorofluorocarbons (HCFCs), Hydrobromofluorocarbons (HBFCs) or other ozone depleting substances in any phase of the manufacturing process.

## Storage Condition

The performance of these products, including the solderability, is guaranteed for a year from the date of arrival at your company, provided that they remain packed as they were when delivered and stored at a temperature of 25°C ± 10°C and a relative humidity of 60%RH ± 10%RH, chemical and dust free atmosphere

Even within the above guarantee periods, do not store these products in the following conditions. Otherwise, their electrical performance and/or solderability may be deteriorated, and the packaging materials (e.g. taping materials) may be deformed or deteriorated, resulting in mounting failures.

1. In salty air or in air with a high concentration of corrosive gas, such as Cl<sub>2</sub>, H<sub>2</sub>S, NH<sub>3</sub>, SO<sub>2</sub>, or NO<sub>2</sub>
2. In direct sunlight

## How To Order

ROX	1S	J	100K		
Common Part	Power Rating		Tolerance	Resistance Value	Special Request
ROX – Flame proof power metal oxide film resistor	<b>Normal size</b>	<b>Small size</b>		R33 -0.33Ω	BL * – Pre-formed Leads
	025 - 1/4W	05S – 1/2W		1R0 - 1Ω	
	05 – 1/2W	1S – 1W	G – 2%	10R - 10Ω	
	1 – 1W	2S – 2W	J – 5%	100R - 100Ω	
	2 – 2W	3S – 3W		1K0 – 1KΩ	
	3 – 3W	4S – 4W		(1000Ω)	TR - Reeled
	5 – 5W	5SS – 5W		100K – 100KΩ	
	7 – 7W	5S – 5W		(100,000Ω)	
	8 – 8W				
	9 – 9W				