

# MPI5451

## High current, low profile power inductors



### Applications

- Handheld/mobile devices
- Portable media players
- MP3 Players
- Battery operated devices
- Notebook/netbook
- Tablets/smartbooks
- LCD Displays
- LED Drivers

### Environmental data

- Storage temperature range (Component): -40°C to +125°C
- Operating temperature range: -40°C to +125°C (ambient + self-temperature rise)
- Solder reflow temperature: J-STD-020D compliant

### Product description

- Halogen free, lead free, RoHS compliant
- 125°C maximum total temperature operation
- 5.74 x 5.43 footprint surface mount package with either 1.2 or 2.0mm heights
- Magnetically shielded, low EMI
- Rugged construction
- Inductance range from 0.33µH to 15µH
- Current range from 1.1 to 11.5 amps

### Packaging

- Supplied in tape and reel packaging on a 13" diameter reel



Discontinued, Effective February 1, 2016 or until inventory is depleted. No recommendation available replacement available

Product specifications

Part Number <sup>5</sup>	OCL <sup>1</sup> ( $\mu\text{H}$ ) $\pm 20\%$	$I_{\text{rms}}^2$ (Amps)	$I_{\text{sat}}^3$ (Amps)	DCR ( $\text{m}\Omega$ ) @ 25°C $\pm 20\%$	K-Factor <sup>4</sup>
R1 - 1.2mm height					
MPI5451R1-R33-R	0.33	6.5	11.5	13	1244
MPI5451R1-R47-R	0.47	6.1	10.9	18	995
MPI5451R1-1R0-R	1.0	4.2	7.2	30	622
MPI5451R1-1R5-R	1.5	3.4	6.1	48	498
MPI5451R1-2R2-R	2.2 $\pm 15\%$	2.6	4.8	70	452
MPI5451R1-3R3-R	3.3 $\pm 15\%$	2.3	3.8	95	355
MPI5451R1-4R7-R	4.7 $\pm 15\%$	2.1	3.5	120	293
MPI5451R1-5R6-R	5.6 $\pm 15\%$	1.9	3.1	145	249
MPI5451R1-6R8-R	6.8 $\pm 15\%$	1.7	2.8	175	237
MPI5451R1-100-R	10.0 $\pm 15\%$	1.3	2.5	290	199
MPI5451R1-150-R	15.0 $\pm 15\%$	1.1	2.2	400	155
R3 - 2.0mm height					
MPI5451R3-R47-R	0.47	6.0	9.0	8.8	1244
MPI5451R3-R68-R	0.68	5.9	8.0	9.5	995
MPI5451R3-1R0-R	1.0	5.1	6.6	14	711
MPI5451R3-1R5-R	1.5	5.0	5.8	16	553
MPI5451R3-2R2-R	2.2	4.1	5.0	24	452
MPI5451R3-3R3-R	3.3	3.7	4.2	33	383
MPI5451R3-4R7-R	4.7	3.0	3.8	50	293
MPI5451R3-6R8-R	6.8	2.6	3.0	70	249
MPI5451R3-100-R	10.0	2.1	2.4	110	207

- Open Circuit Inductance (OCL) Test Parameters: 100kHz, 0.1V<sub>rms</sub>, 0.0Adc, 25°C
- $I_{\text{rms}}$ : DC current for an approximate temperature rise of 40°C without core loss. Derating is necessary for AC currents. PCB layout, trace thickness and width, air-flow, and proximity of other heat generating components will affect the temperature rise. It is recommended that the temperature of the part not exceed 125°C under worst case operating conditions verified in the end application.
- $I_{\text{sat}}$ : Peak current for approximately 20% rolloff at +25°C

- K-factor: Used to determine  $B_{\text{pp}}$  for core loss (see graph).  $B_{\text{pp}} = K * L * \Delta I$ .  $B_{\text{pp}}$ : (Gauss), K: (K-factor from table), L: (Inductance in  $\mu\text{H}$ ),  $\Delta I$  (Peak to peak ripple current in Amps).
- Part Number Definition: MPI5451Rx-yyy-R  
 - MPI5451Rx = Product code and size  
 - yyy= Inductance value in  $\mu\text{H}$ , R = decimal point, if no R is present then third character = number of zeros  
 - "R" suffix = RoHS compliant

Dimensions - mm

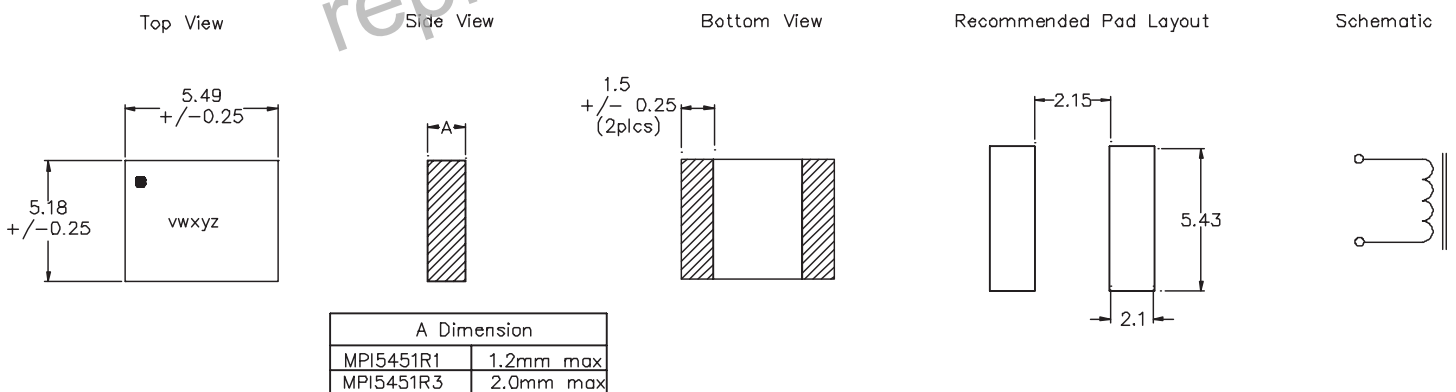

Part Marking : wxyz  
 v = height: 1 = R1 (1.2mm), 3 = R3 (2.0mm)  
 w = inductance value per the "Part Marking Designator" letter code in table above  
 x = Bi-weekly date code  
 y = Last digit of year manufactured  
 z = Revision level

Packaging information - mm

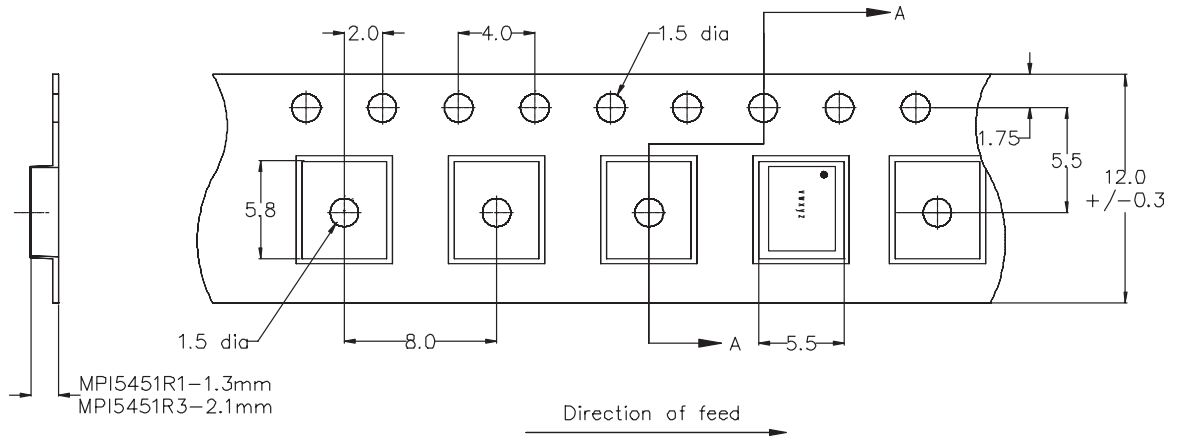

Section A-A

Supplied in tape and reel packaging.  
MPI5451R1 4000 parts per 13" diameter reel  
MPI5451R3 3000 parts per 13" diameter reel

Core loss

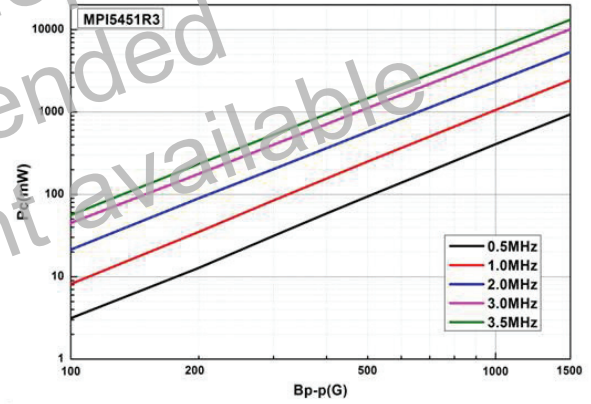
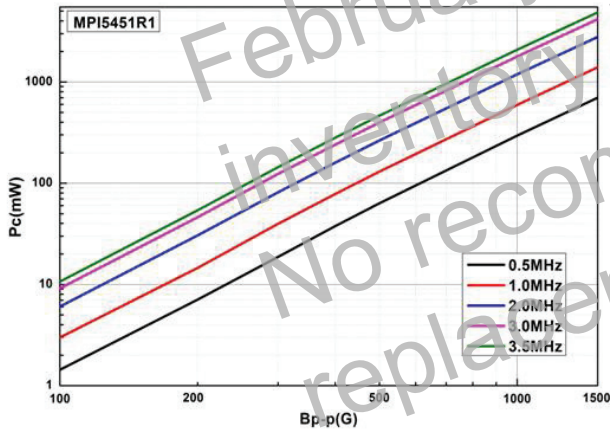

Discontinued, Effective February 1, 2016 or until inventory is depleted. No recommended replacement available.

Inductance characteristics / temperature rise

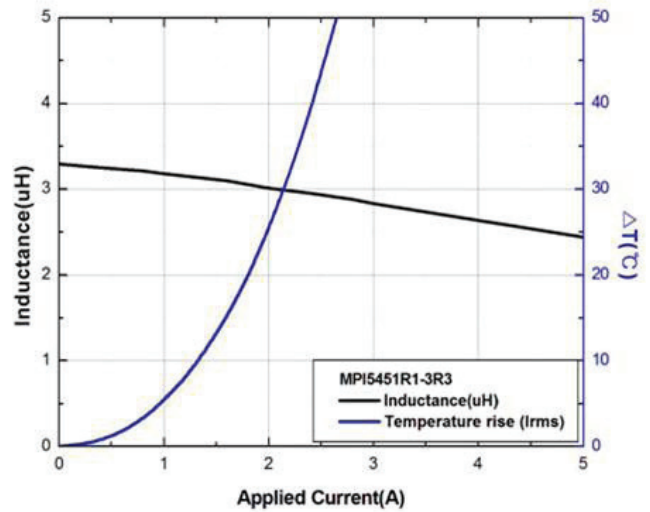
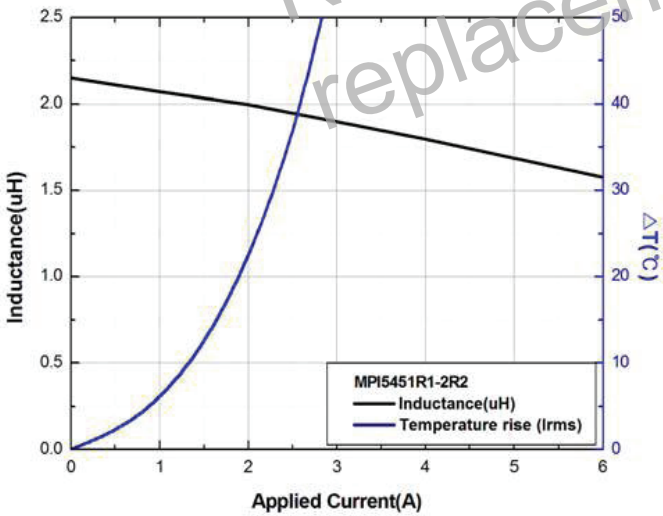
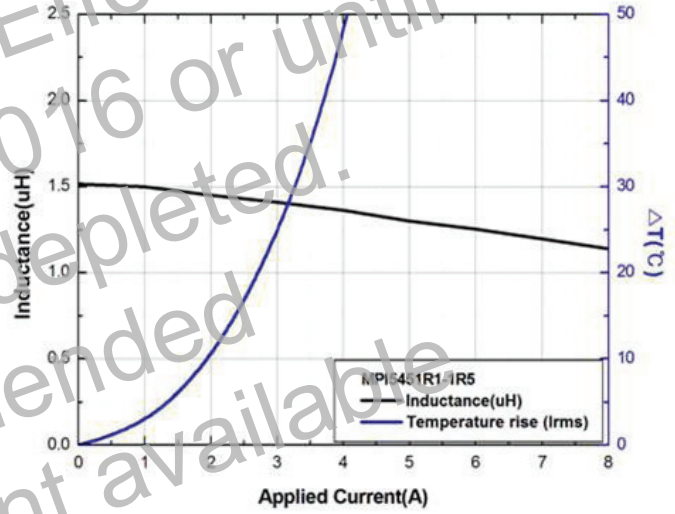
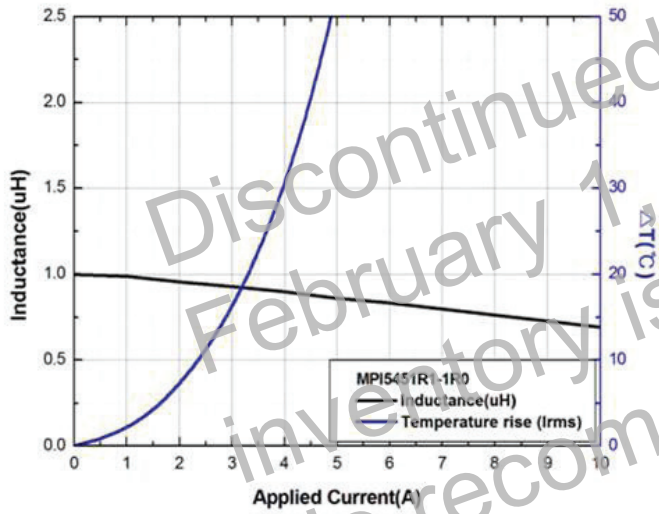
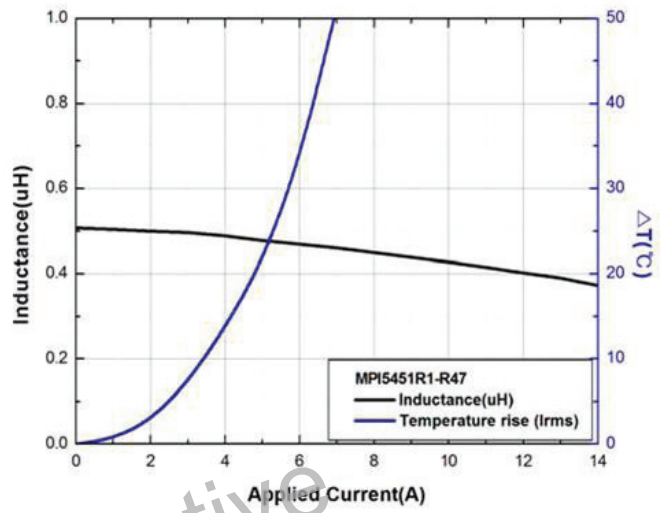
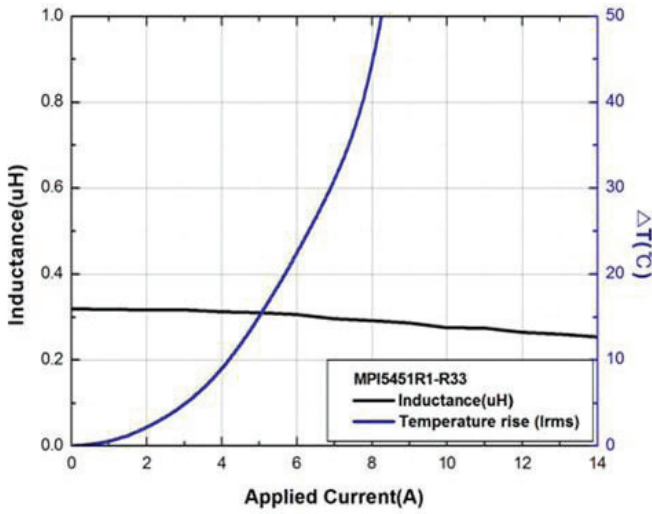

Inductance characteristics / temperature rise

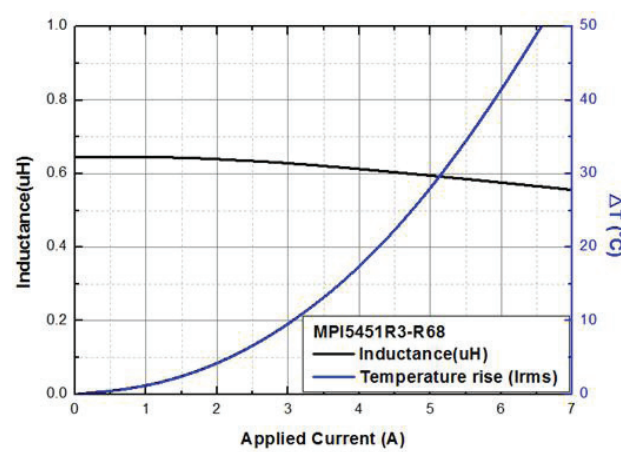
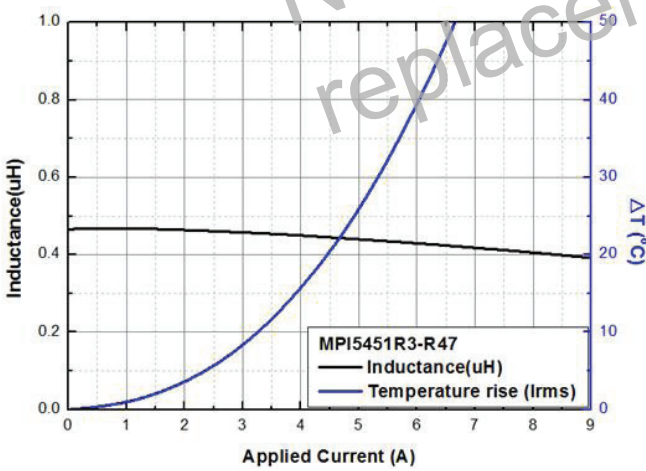
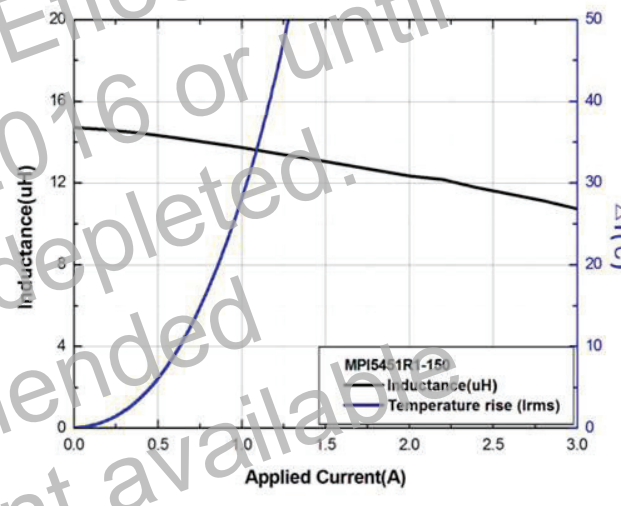
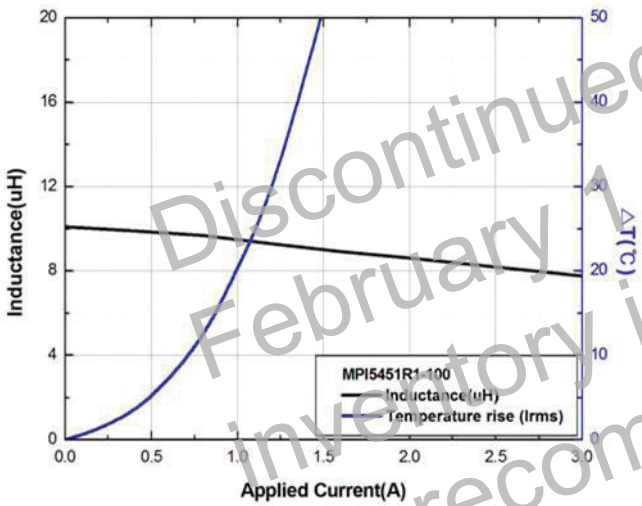
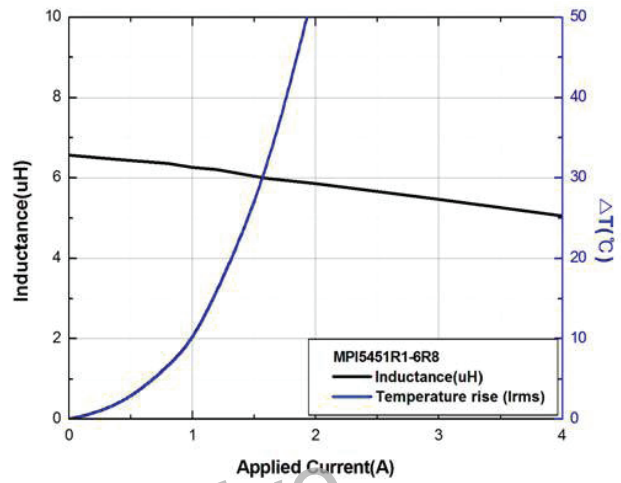
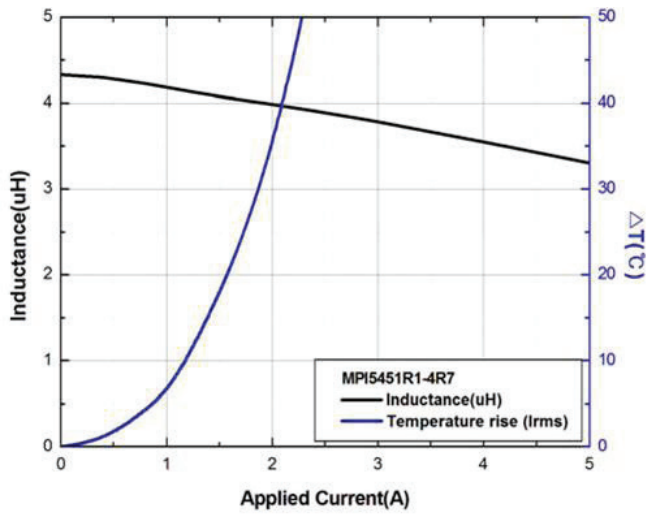

Inductance characteristics / temperature rise

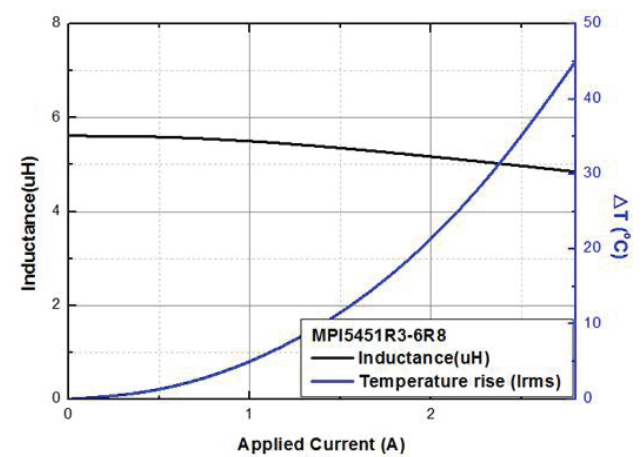
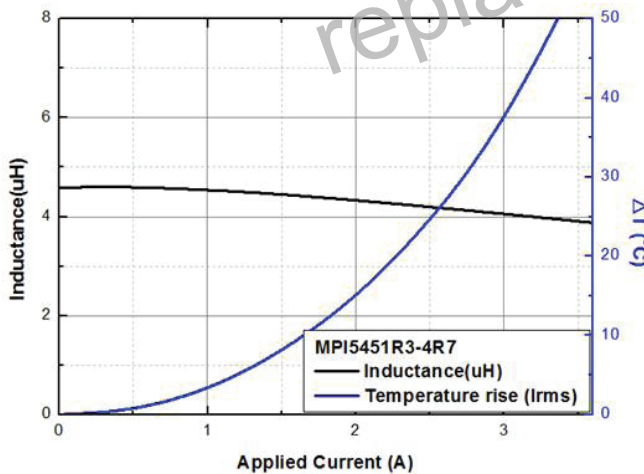
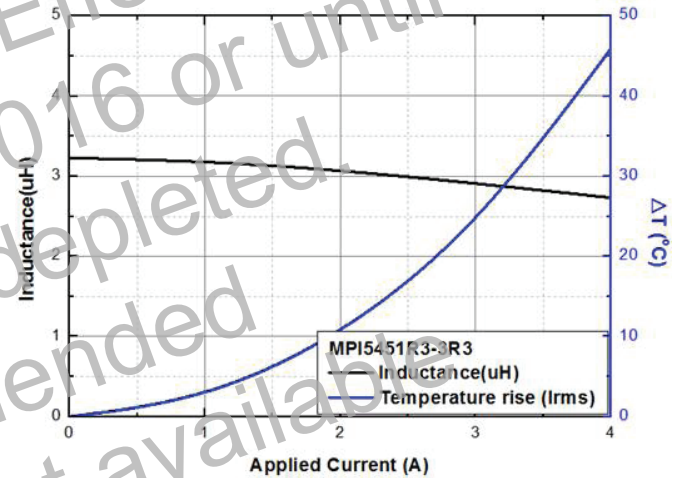
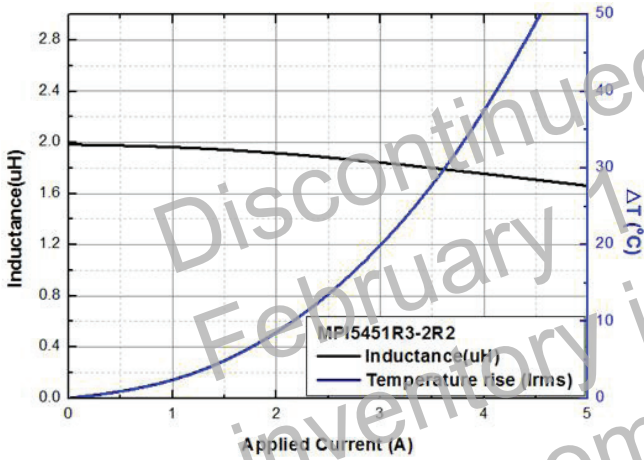
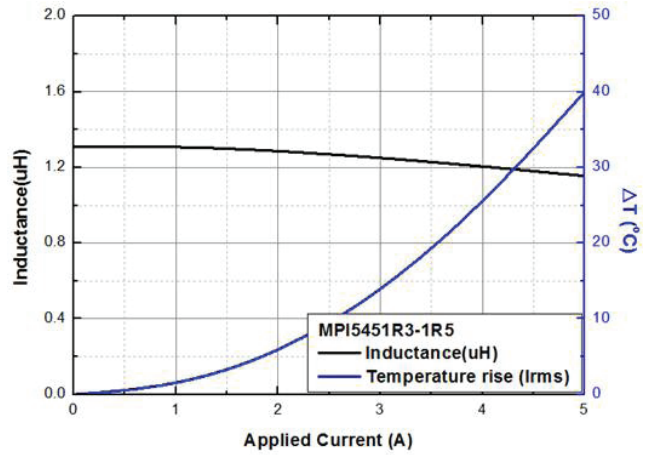
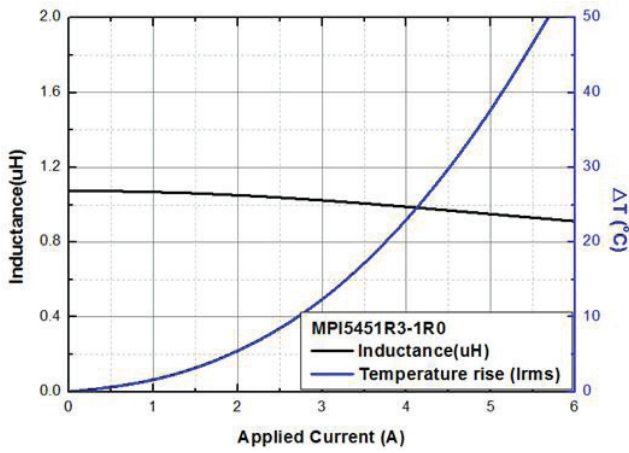

Discontinued, Effective  
February 1, 2016 or until  
inventory is depleted.  
No recommendation  
replacement available

Inductance characteristics / temperature rise

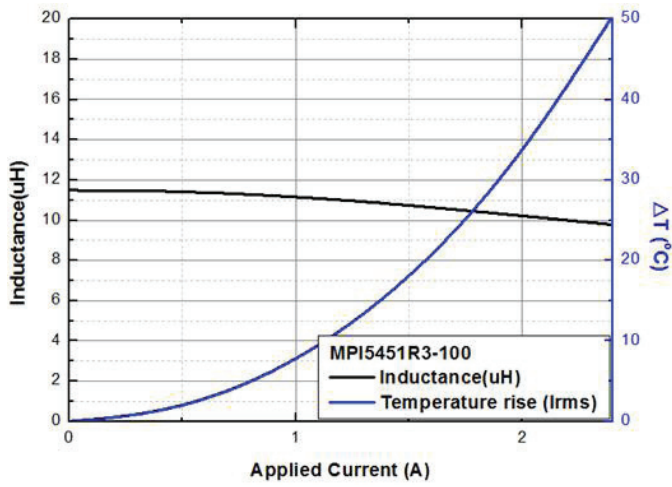

Discontinued, Effective  
February 1, 2016 or until  
inventory is depleted.  
No recommended  
replacement available

**Solder reflow profile**

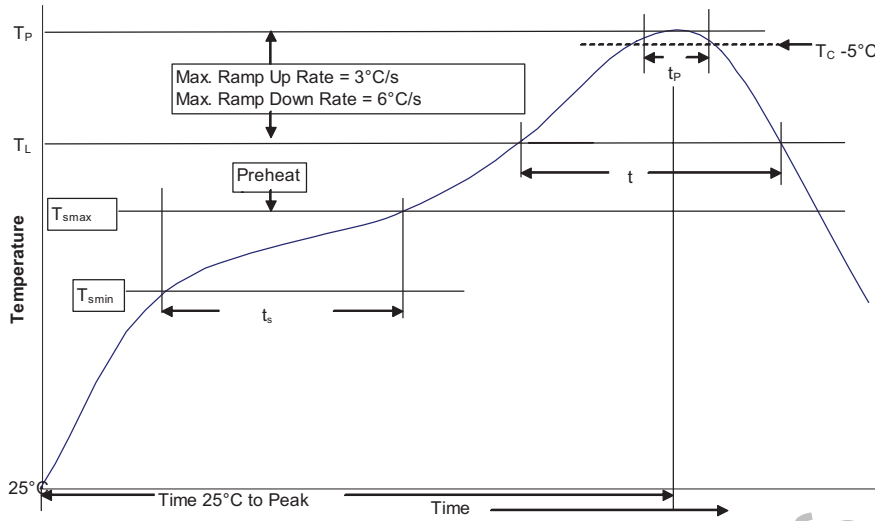

**Table 1 - Standard SnPb Solder ( $T_c$ )**

Package Thickness	Volume $\leq 350$ mm <sup>3</sup>	Volume $\geq 350$ mm <sup>3</sup>
<2.5mm	235°C	220°C
$\geq 2.5$ mm	220°C	220°C

**Table 2 - Lead (Pb) Free Solder ( $T_c$ )**

Package Thickness	Volume $\leq 350$ mm <sup>3</sup>	Volume 350 - 2000 mm <sup>3</sup>	Volume $>2000$ mm <sup>3</sup>
<1.6mm	260°C	260°C	260°C
1.6 – 2.5mm	260°C	250°C	245°C
>2.5mm	250°C	245°C	245°C

**Reference JDEC J-STD-020D**

Profile Feature	Standard SnPb Solder	Lead (Pb) Free Solder
Preheat and Soak		
• Temperature min. ( $T_{smin}$ )	100°C	150°C
• Temperature max. ( $T_{smax}$ )	150°C	200°C
• Time ( $T_{smin}$ to $T_{smax}$ ) ( $t_s$ )	60-120 Seconds	60-120 Seconds
Average ramp up rate $T_{smax}$ to $T_p$	3°C/ Second Max.	3°C/ Second Max.
Liquidous temperature ( $T_L$ )	183°C	217°C
Time at liquidous ( $t_L$ )	60-150 Seconds	60-150 Seconds
Peak package body temperature ( $T_p$ )	Table 1	Table 2
Time ( $t_p$ )** within 5 °C of the specified classification temperature ( $T_c$ )	20 Seconds**	30 Seconds**
Average ramp-down rate ( $T_p$ to $T_{smax}$ )	6°C/ Second Max.	6°C/ Second Max.
Time 25°C to Peak Temperature	6 Minutes Max.	8 Minutes Max.

\* Tolerance for peak profile temperature ( $T_p$ ) is defined as a supplier minimum and a user maximum.

\*\* Tolerance for time at peak profile temperature ( $t_p$ ) is defined as a supplier minimum and a user maximum.

Life Support Policy: Eaton does not authorize the use of any of its products for use in life support devices or systems without the express written approval of an officer of the Company. Life support systems are devices which support or sustain life, and whose failure to perform, when properly used in accordance with instructions for use provided in the labeling, can be reasonably expected to result in significant injury to the user.

Eaton reserves the right, without notice, to change design or construction of any products and to discontinue or limit distribution of any products. Eaton also reserves the right to change or update, without notice, any technical information contained in this bulletin.

**Eaton**  
Electronics Division  
1000 Eaton Boulevard  
Cleveland, OH 44122  
United States  
www.eaton.com/elx



© 2014 Eaton  
All Rights Reserved  
Publication No. 10247 – BU-SB14346  
June 2014

Eaton is a registered trademark.

All other trademarks are property of their respective owners.