

PCN

AO-PCN-2023-001-A

Introduction of 6" InGaAlP Thinfilm Chip for TOPLED Black Surface

15.03.2023

Dear Customer,

please review this **PCN** and provide your feedback in the **Customer approval form** (at the end of this PCN document) to your ams OSRAM sales partner before **21.04.2023** *).

Your prompt reply will help ams OSRAM to assure a smooth and well executed transition. If ams OSRAM does not hear from your side by the due date, we will assume your (if you are a Distributor: and your customer's) full acceptance to this proposed change and its implementation.

ams OSRAM understands the time requirements your organization needs to approve this PCN. However, if you can provide ams OSRAM an estimated date your organization will have finalized this PCN review, ams OSRAM can use this date to plan continued production to secure your order needs during the transition time.

Your attention and response to this matter is highly appreciated.

Please direct your inquiries to your local Sales office.

- *) ams OSRAM aligns with the widely recognized JEDEC/ECIA/IPC Joint Standard No. 46, which stipulates:
- Customers should acknowledge receipt of the PCN within 30 days of delivery of the PCN.
 - Lack of acknowledgement of the PCN within 30 days constitutes acceptance of the change.
 - After acknowledgement, lack of additional response within the 90 day period constitutes acceptance of the change. If the customer requires additional time to perform sample testing, beyond the 90 day review period, an extension must be negotiated with the supplier.

Subject of change:	Introduction of 6" InGaAlP Thinfilm Chip for Topled Black Surface	
Affected products:	LY T68F LR T68F	
Reason for change:	<ul style="list-style-type: none"> • Introduction of latest 6" chip technology to secure continuous supply • Brightness increase • Update of datasheet to latest format and correction of input, where needed. 	
Description of change:	For details refer to document 2_cip_AO-PCN-2023-001-A	
Product identification:	Date code: 2523 (WWYY)	
Time schedule for PCN material: (after implementation of change):	Final qualification report:	01.03.2023
	Samples available:	15.03.2023
	Intended Start of delivery:	15.06.2023 ^{*)} <small>*) or earlier if released by customer and upon mutual agreement</small>
Time schedule for Pre-PCN material: (prior to implementation of change):	Last time order date (LTO):	30.06.2024 ^{**)} <small>***) Lead time and LTO quantity shall be mutually agreed between OSRAM OS and customer.</small>
	Last time delivery date (LTD):	31.12.2024 ^{***)} <small>***) planned last date for delivery of products of current status</small>
Assessment:	No change of product reliability	
Documentation:	Customer information package 2_cip_AO-PCN-2023-001-A; 3_cip_AO-PCN-2023-001-A_Rel	

Note:

Pre-PCN material: Products of current status, means before implementation of the changes as described in the PCN.

PCN material: Products with implementation of the changes as described in the PCN.

Customer approval form AO-PCN-2023-001-A

Introduction of 6" InGaAlP Thinfilm Chip for TOPLED Black Surface

Please list product(s) affected in your application(s):

Please check the appropriate box below:

- | | |
|--|---|
| <input type="radio"/> Approval:
We agree with the proposed change and accept start of the shipment upon availability of PCN material | <input type="radio"/> Not relevant:
Change is not relevant for products in use. |
| <input type="radio"/> Change cannot be accepted: | |
| <input type="radio"/> We have objections: | |
| <input type="radio"/> We request following Information: | |
| <input type="radio"/> We request following Samples: | |
| <input type="radio"/> Expected approval date: | |
| <input type="radio"/> Volume requirements for Pre-PCN material: | |
| <input type="radio"/> Remarks: | |
-

Sender:

Company:

Address / Location:

Signature:

Date:

Please return this approval form to your Sales partner.

Sensing is life



PCN AO-PCN-2023-001-A Introduction of 6" InGaAlP Thinfilm Chip for TOPLED Black Surface

Customer information package



R&D-PD-LED-TLM and OS Q CQM ICI
2023-03-15

Agenda

	Page
1. Reason for change	3
2. Description of change	4
3. Changes in the datasheets	5-15
4. List of affected products	16
5. PCN samples	17
6. Time schedule	18

AO-PCN-2023-001-A

Introduction of 6” InGaAlP Thinfilm Chip for Topled Black Surface



Reason for change

Item	Description
1.	Introduction of latest 6” chip technology to secure continuous supply
2.	Brightness increase
3.	Update of datasheet to latest format and correction of input, where needed.

AO-PCN-2023-001-A

Introduction of 6" InGaAlP Thinfilm Chip for Topled Black Surface

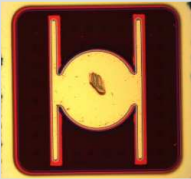
Description of change: new red/yellow chip

Item	Current status	2 nd source chip
Picture (schematic)		
Wafer size [mm]	100 (4")	150 (6")
Chip carrier substrate	Ge	Si
Chip size [μm]	250 x 250	175 x 175
Height [μm]	150	120

AO-PCN-2023-001-A

Introduction of 6” InGaAlP Thinfilm Chip for Topped Black Surface

Changes in the datasheets:

Page	Change Item	Reason	Old	New
1	Applications	New layout	Electronic Equipment, Traffic lights, VMS, White Goods	Projection & Display
2	Datasheet Q#	Change	LR: U1AA (450...1400mcd) - Q65110A7321 LR: U2V2 (560...1120mcd) - Q65110A9561 LY: V1AA (710...1400mcd) - Q65110A7322 Q65110A8502 Q65110A8587 LY: U1AA (450... 1400mcd) - Q65110A7730 LY: T2V2 (355...1120mcd) - Q65110A7796	LR: U2AB (560 ... 1800 mcd) - Q65113A6141 LY: U2AA (560 ... 1400 mcd) - Q65113A5974 LY: -U2AB (560 ... 1800 mcd) - Q65113A5973 LY: V1AB (710 ... 1800 mcd) - Q65113A5972
3	Spectral Bandwidth at 50% I _{rel} max	Change	LR: 19nm LY: 18nm	LR: 16nm LY: 15nm
4	Forward Voltage – typ. I _F = 20 mA	Change	LR: 2.05V LY: 2.2V (no change)	LR: 2.15V LY: 2.2V (no change)
5	TC of Peak Wavelength	Change	LR: 0.14 nm / K LY: 0.12 nm / K	LR: 0.18 nm / K LY: 0.17 nm / K
6	TC of Dominant Wavelength	Change	LR: 0.07 nm / K (no change) LY: 0.1 nm / K	LR: 0.07 nm / K (no change) LY: 0.16 nm / K
7	R _{th} JA real_max	Harmonization	500 K/W	-
8	R _{th} JS real_typ	Harmonization	-	140 K/W
9	Brightness Groups	Change	LR: U1-AA LY: T2-AA	LR: U2-AB LY: U2-AB

AO-PCN-2023-001-A

Introduction of 6" InGaAlP Thinfilm Chip for Topled Black Surface

Changes in the datasheets: Spectral Emission LR T68F:

Old

Relative Spectral Emission ⁷⁾

$I_{rel} = f(\lambda); I_F = 20 \text{ mA}; T_S = 25 \text{ }^\circ\text{C}$

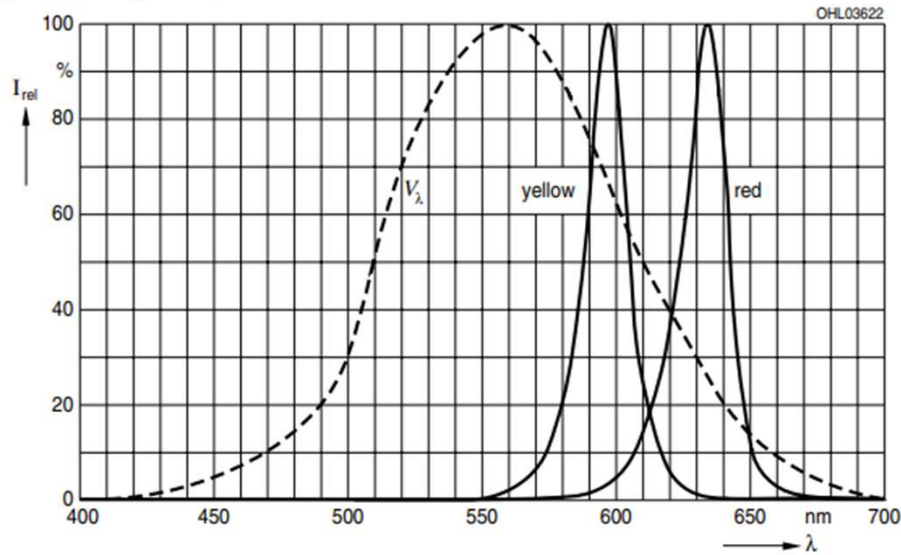

New

Relative Spectral Emission ⁶⁾

$I_{rel} = f(\lambda); I_F = 20 \text{ mA}; T_S = 25 \text{ }^\circ\text{C}$

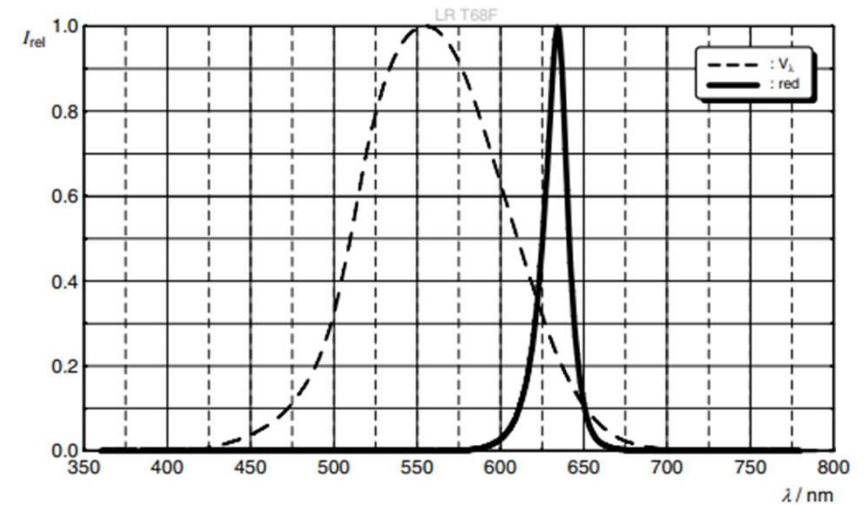

AO-PCN-2023-001-A

Introduction of 6" InGaAlP Thinfilm Chip for Topped Black Surface

Changes in the datasheets: Spectral Emission LY T68F:

Old

Relative Spectral Emission ⁷⁾

$I_{rel} = f(\lambda); I_F = 20 \text{ mA}; T_S = 25 \text{ }^\circ\text{C}$

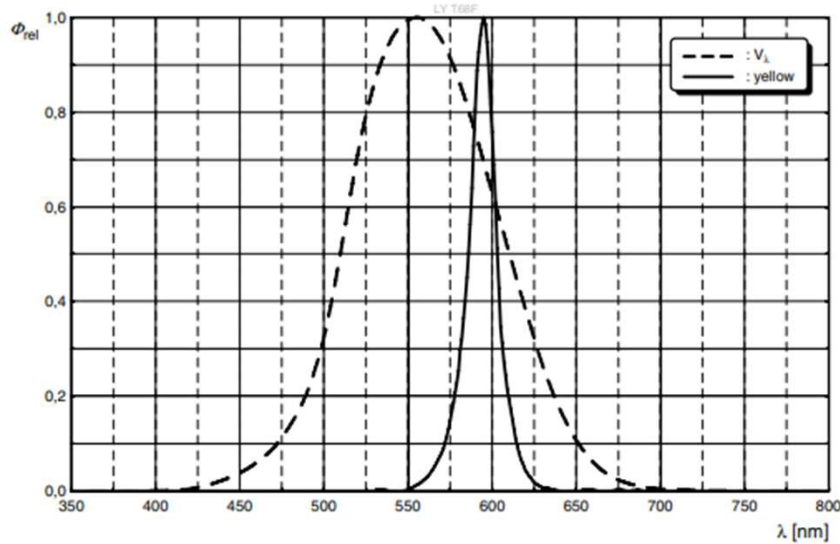

New

Relative Spectral Emission ⁶⁾

$I_{rel} = f(\lambda); I_F = 20 \text{ mA}; T_S = 25 \text{ }^\circ\text{C}$

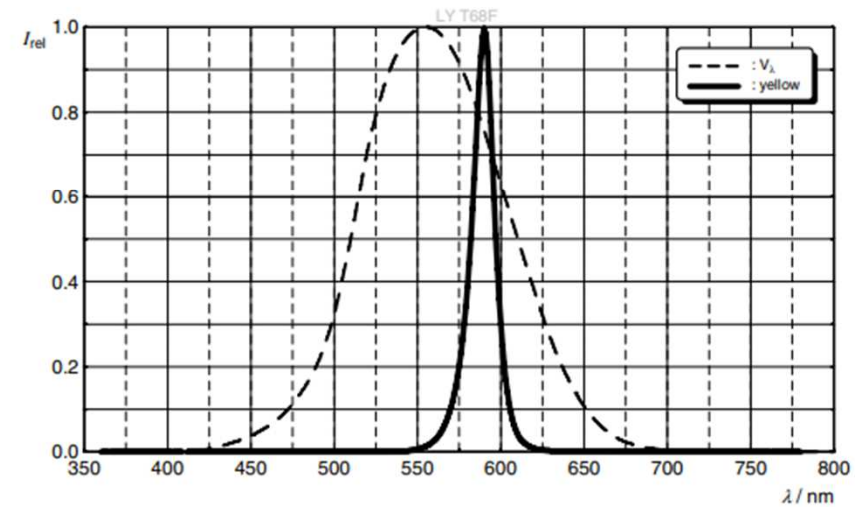

AO-PCN-2023-001-A

Introduction of 6" InGaAlP Thinfilm Chip for Topled Black Surface

Changes in the datasheets: Radiation Characteristics LR T68F:

Old

New

Radiation Characteristics ^{7), 8)}

$$I_{rel} = f(\phi); T_s = 25\text{ }^\circ\text{C}$$

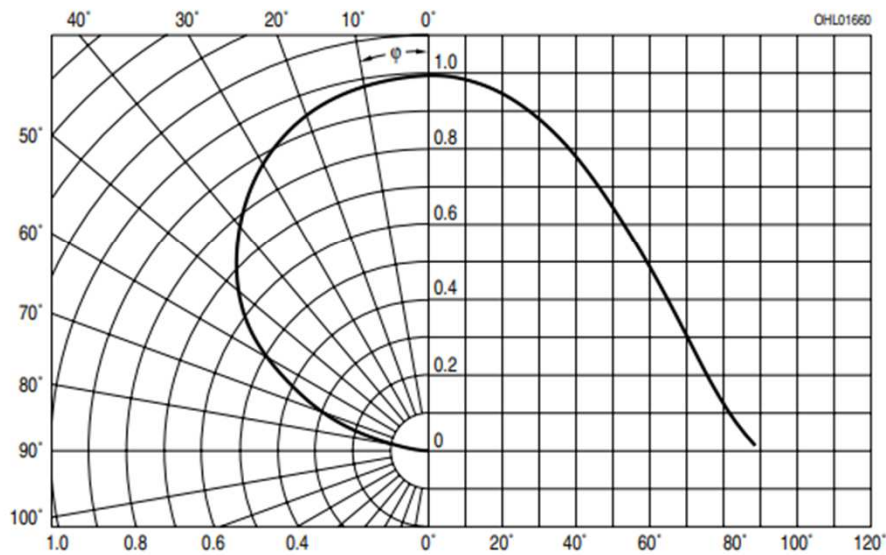

Radiation Characteristics ⁶⁾

$$I_{rel} = f(\phi); T_s = 25\text{ }^\circ\text{C}$$

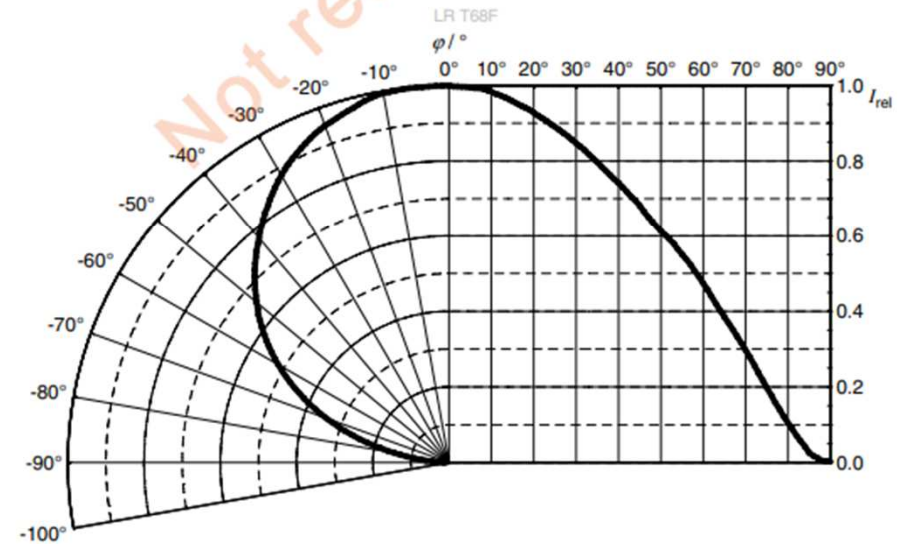

AO-PCN-2023-001-A

Introduction of 6" InGaAlP Thinfilm Chip for Topped Black Surface

Changes in the datasheets: Radiation Characteristics LY T68F:

Old

Radiation Characteristics ⁷⁾

$$I_{rel} = f(\phi); T_s = 25\text{ }^\circ\text{C}$$

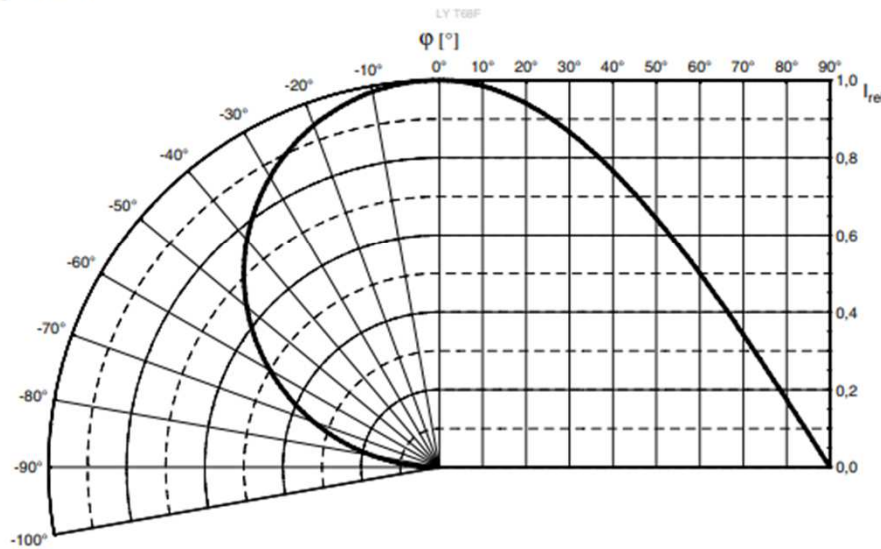

New

Radiation Characteristics ⁶⁾

$$I_{rel} = f(\phi); T_s = 25\text{ }^\circ\text{C}$$

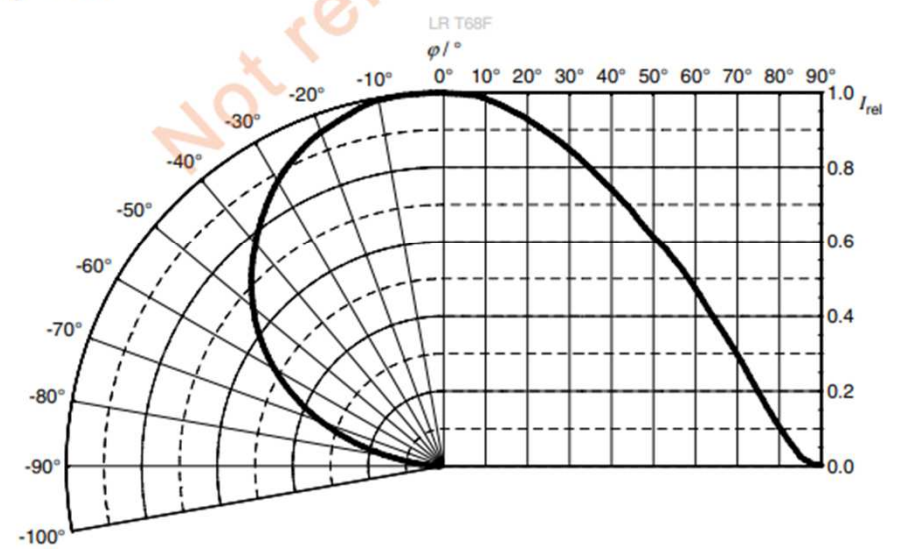

AO-PCN-2023-001-A

Introduction of 6" InGaAlP Thinfilm Chip for Topled Black Surface

Changes in the datasheets: Forward Current:

Old LR T68F	Old LY T68F	New LR T68F	New LY T68F
-------------	-------------	-------------	-------------

Forward current ^{7), 9)}

$$I_F = f(V_F); T_S = 25\text{ °C}$$

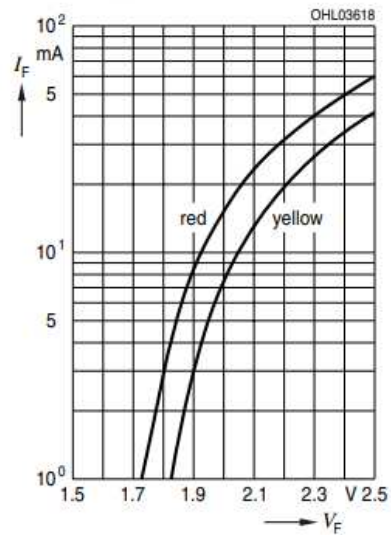

Forward current ^{7), 8)}

$$I_F = f(V_F); T_S = 25\text{ °C}$$

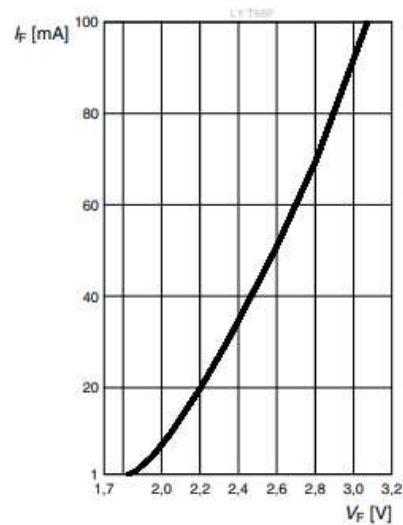

Forward current ⁶⁾

$$I_F = f(V_F); T_S = 25\text{ °C}$$

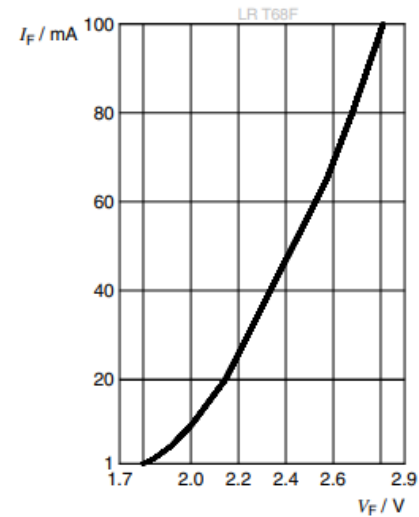

Forward current ⁶⁾

$$I_F = f(V_F); T_S = 25\text{ °C}$$

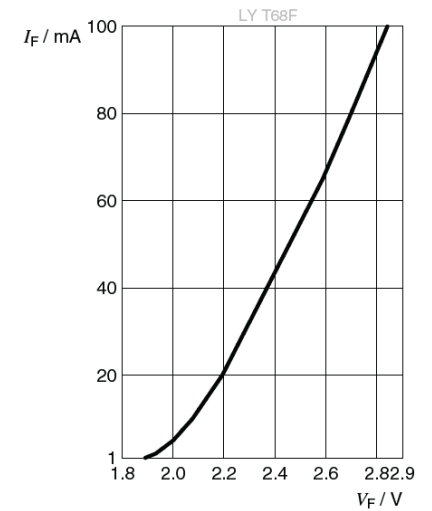

AO-PCN-2023-001-A

Introduction of 6" InGaAlP Thinfilm Chip for Topled Black Surface

Changes in the datasheets: Relative Luminous Intensity (I_f):

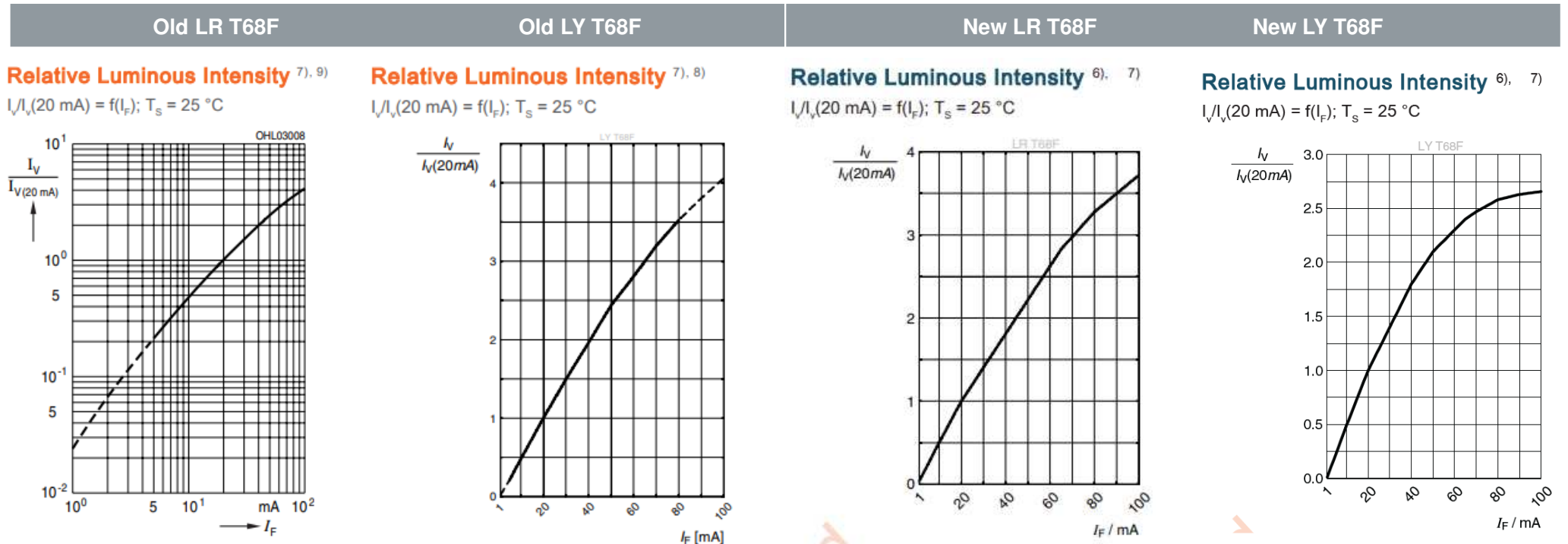

AO-PCN-2023-001-A

Introduction of 6" InGaAlP Thinfilm Chip for Topled Black Surface

Changes in the datasheets: Forward Voltage (Tj)

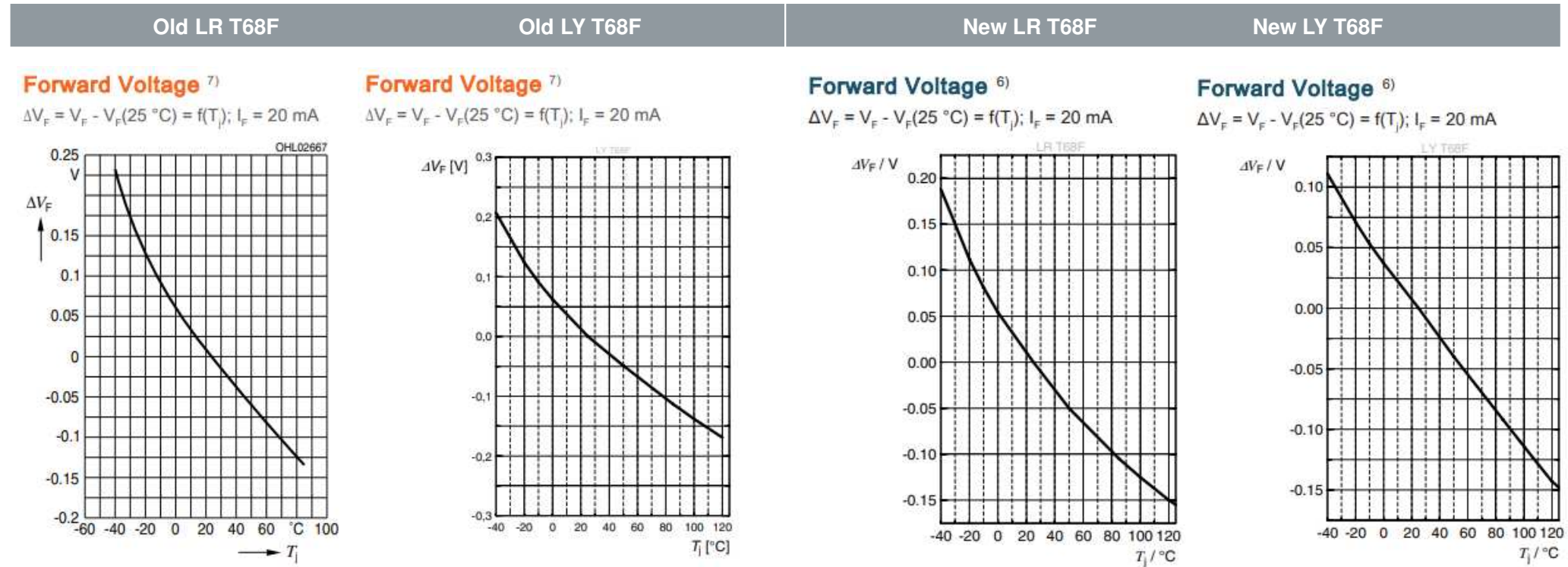

AO-PCN-2023-001-A

Introduction of 6" InGaAlP Thinfilm Chip for Topled Black Surface

Changes in the datasheets: Relative Luminous Intensity (Tj):

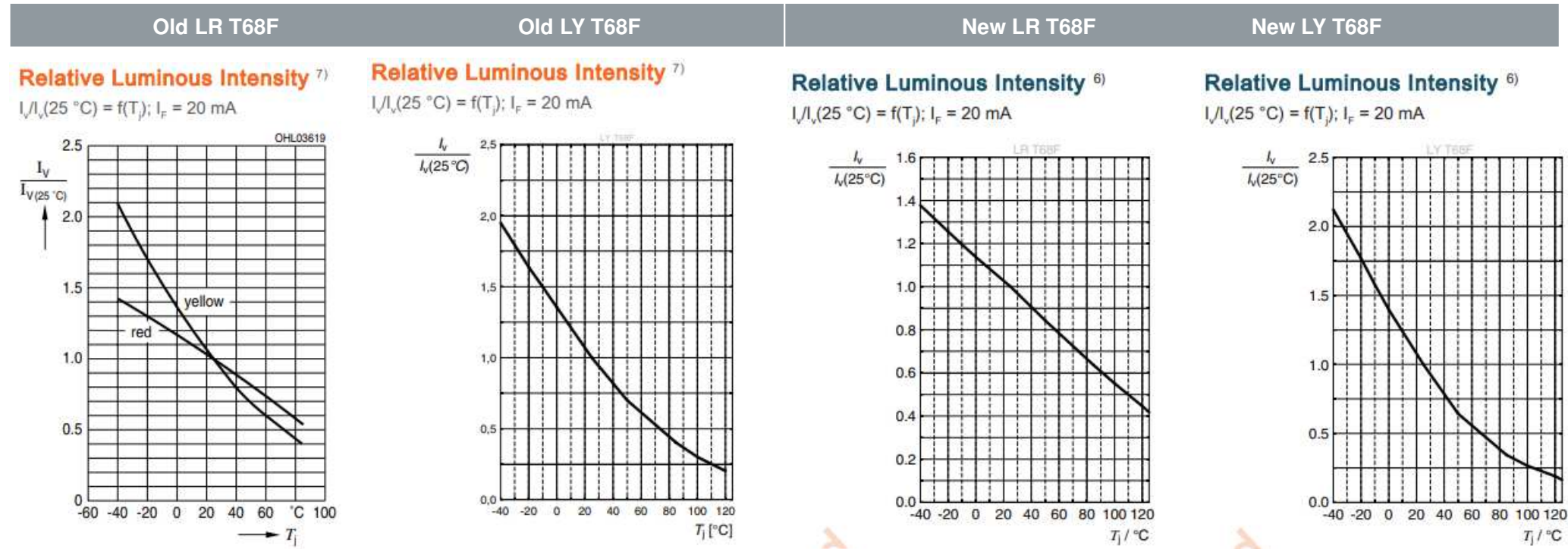

AO-PCN-2023-001-A

Introduction of 6" InGaAlP Thinfilm Chip for Topled Black Surface

Changes in the datasheets: Max. Permissible Forward Current

Old

New

Max. Permissible Forward Current

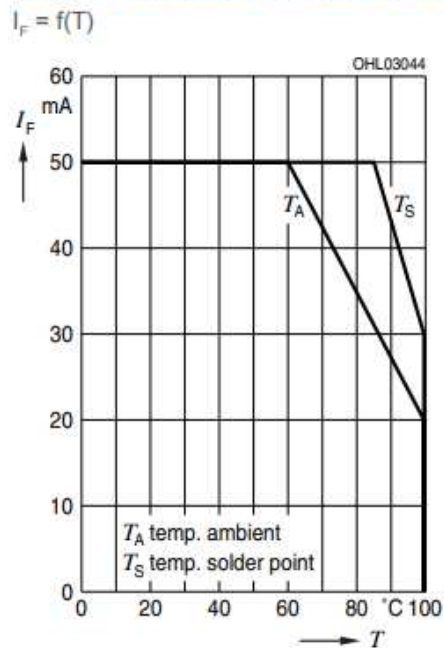

Max. Permissible Forward Current

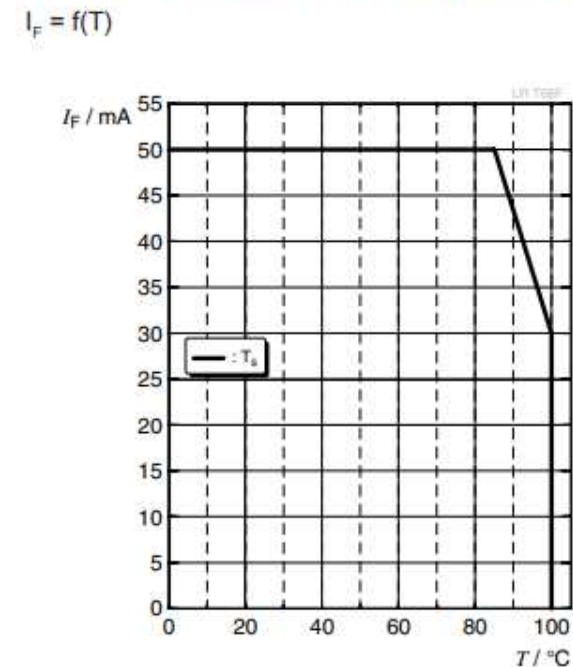

AO-PCN-2023-001-A

Introduction of 6” InGaAlP Thinfilm Chip for Topled Black Surface

Changes in the datasheets: Updated Datasheet Version

Product type	Data sheet version <u>before PCN</u>	Data sheet version <u>after PCN</u>
LY T68F	1.2	1.3
LR T68F	1.2	1.3

AO-PCN-2023-001-A

Introduction of 6” InGaAlP Thinfilm Chip for Topled Black Surface

List of affected products

Brand	
Topled Black Surface	LY T68F LR T68F

AO-PCN-2023-001-A

Introduction of 6” InGaAlP Thinfilm Chip for Topled Black Surface

PCN Samples

Brand	
Topled Black Surface	LY T68F LR T68F

Color code: available on request

AO-PCN-2023-001-A

Introduction of 6” InGaAlP Thinfilm Chip for Topled Black Surface

Time schedule

for PCN material (<u>after</u> implementation of change):		
Final qualification report	01.03.2023	
Samples available	15.03.2023	
Intended start of delivery	15.06.2023 ^{*)}	^{*)} or earlier if released by customer and upon mutual agreement

for Pre-PCN material (<u>prior to</u> implementation of change):		
Last time order date (LTO)	30.06.2024 ^{**)}	^{**)} Lead time and LTO quantity shall be mutually agreed between OSRAM OS and customer.
Last time delivery date (LTD)	31.12.2024 ^{***)}	^{***)} planned last date for delivery of products of current status

Note:
 Pre-PCN material: Products of current status, means before implementation of the changes as described in the PCN.
 PCN material: Products with implementation of the changes as described in the PCN.

Sensing is life

am  OSRAM

Qualification Report 230016C1

Subject	Qualification of TOPLED Black Surface according to AO-PCN-2023-001-A
Date	01.03.2023
Tested device	LY T68F; LR T68F
Brand (including sub brands)	TOPLED® Black Surface
Applies to	LY T68F; LR T68F

Pre-conditioning according to Jedec Level III

Test Performed	Condition	Duration	Sample Size	Failures		
				EI.	Opt.	Vis
Wet High Temperature Operating Life WHTOL1 <i>JESD22-A101</i>	$T_A = 85^\circ\text{C}$; r.H.= 85% $I_F = 30\text{mA}$	1000h	3x30 ^{A)B)D} 2x22 ^{C)E)}	0	0	0
Wet High Temperature Operating Life WHTOL2 <i>JESD22-A101</i>	$T_A = 85^\circ\text{C}$; r.H.= 85% $I_F = 1\text{mA}$	1000h	5x30	0	0	0
Temperature Cycling TC <i>JESD22-A104</i>	$T_A = -40^\circ\text{C}/+100^\circ\text{C}$ 15min each extreme	500c	5x30	0	0	0
Powered Temperature Cycle PTC <i>JESD22-A105</i>	$T_A = -40^\circ\text{C}/+100^\circ\text{C}$ $I_F = 30\text{mA}$ ton/off = 5min	1000c	5x30	0	0	0
Pulsed Operating Life PLT <i>JESD22-A108</i>	$T_A = 25^\circ\text{C}$ $I_F = 80\text{mA}$; $t_p = 0,1\text{ms}$; $D = 3\%$	1000h	5x30	0	0	0
High Temperature Operating Life HTOL1 <i>JESD22-A108</i>	$T_A = 85^\circ\text{C}$ $I_F = 30\text{mA}$	1000h	5x30	0	0	0
High Temperature Operating Life HTOL2 <i>JESD22-A108</i>	$T_A = 25^\circ\text{C}$ $I_F = 50\text{mA}$	1000h	5x30	0	0	0
Solderability SD <i>JESD22-B102</i>	$T_A = 245^\circ\text{C}$ $T_A = 260^\circ\text{C}$	3s 10s	5x11	-	-	0

Note:

- 1) LY T68F - Evaluation = Lot A; Lot B Control = Lot C
- 2) LR T68F - Evaluation = Lot D Control = Lot E

Failure criteria:

Electrical failures: V_F ($I_F = 20\text{mA}$) > 2,5V; $\pm 10\%$ from initial value

Optical failures: I_v ($I_F = 20\text{mA}$) > $\pm 30\%$ from initial value
 I_{dom} ($I_F = 20\text{mA}$) $\pm 2\text{ nm}$ from initial value

Visual failures: acc JEDEC JESD22-B101

Conclusion: The tested devices representing the product family as stated in the applies to section fulfill the reliability requirements.

Disclaimer

PLEASE CAREFULLY READ THE BELOW TERMS AND CONDITIONS BEFORE USING THE INFORMATION.
IF YOU DO NOT AGREE WITH ANY OF THESE TERMS AND CONDITIONS, DO NOT USE THE INFORMATION.

The Information contained in this Document does not constitute an independent warranty. The committed behavior is described in the Product data sheet and/or further, mutually agreed specifications.

Distribution of part or all of the contents of this Document to any 3rd party in any form without the prior permission of ams-OSRAM International GmbH is prohibited except in accordance with applicable mandatory law.

Further explanations:

Data: The Data used in this Document consider the reliability test results under the mentioned driving conditions only. For Product information on the maximum operating conditions and the OSRAM standard qualification profile please refer to the Product data sheet or contact your local sales partner.

Conditions: The conditions for the generation of the Data are as follows:

1. The Data and curves shown in this Document are based on experiments carried out under laboratory conditions on a random sample size of LED/IRED/Laser/Detector with readouts at discrete readout times (where applicable). Thus, the Data above represent a limited number of production lots only and may differ between different assembly lots over time (including chip or package changes). Thus, the behavior of the LED/IRED/Laser/Detector in the final application may differ from the Data. The behavior of the LED/IRED/Laser/Detector at conditions or readout times deviating from those stated above may not be deduced from the Data.

2. If applicable:

a) Extended driving conditions:

The tested driving conditions exceed the maximum limits stated in the Product data sheet. Therefore, a reduced lifetime or an accelerated degradation is expected. Failure limits noted in the Document refer to the testing condition according to the OSRAM standard Product qualification profile and not to the actual testing condition.

b) Extended testing duration:

The testing duration exceed the OSRAM standard qualification profile of the mentioned Product. Failure limits noted in the Document refer to the testing duration according to the OSRAM standard Product qualification profile and not to the actual testing duration.

c) Exceeding standard qualification conditions – (Product data sheet limits not affected):

The tested driving conditions exceed the OSRAM standard qualification profile of the mentioned Product. Therefore a reduced lifetime or an accelerated degradation is expected. Failure limits noted in the Document refer to the testing condition according to the OSRAM standard Product qualification profile and not to the actual testing condition.

3. For long term operation additional failure modes of the chip or package can occur which are not shown in this Document.

4. Possible differences in the thermal management of OSRAM and customer's setup may lead to a different aging behavior.

WHTOL1 85°C/85%r.H; 30mA

LY T68F

Lot A

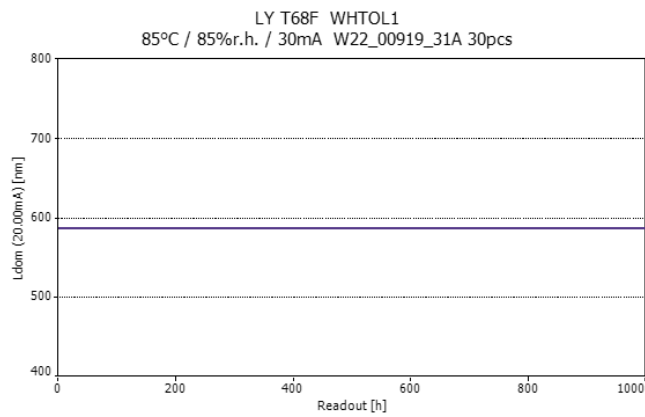
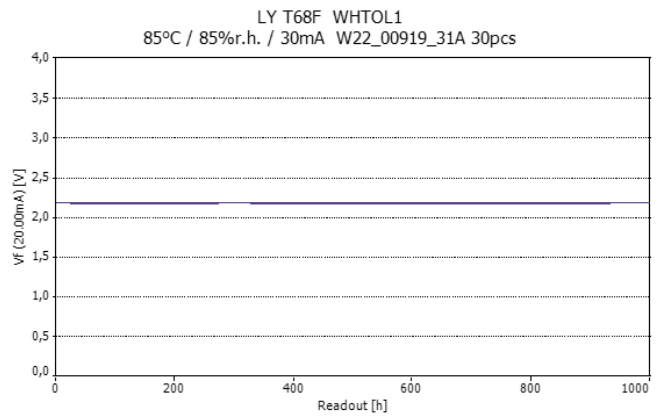
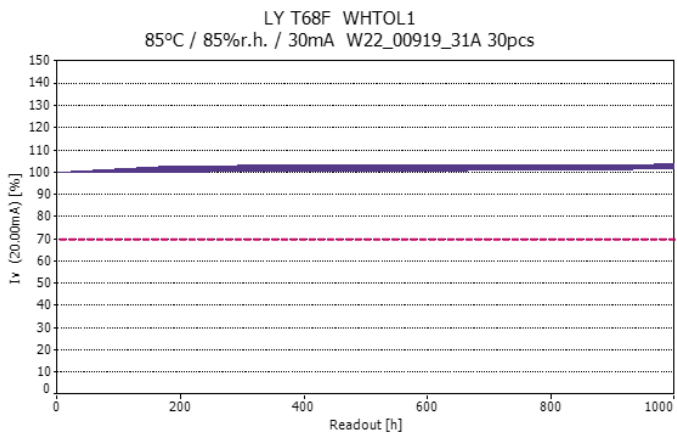

WHTOL1 85°C/85%r.H; 30mA

LY T68F

Lot B

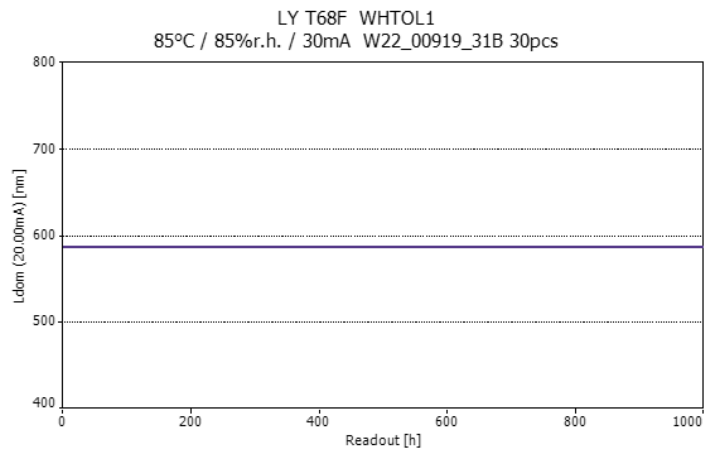
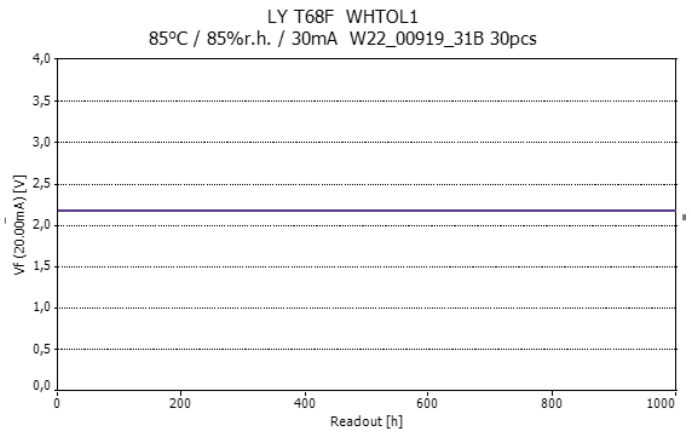
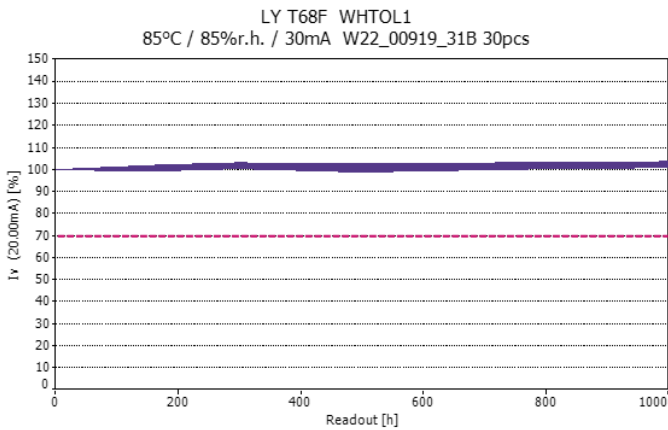

WHTOL1 85°C/85%r.H; 30mA

LY T68F

Lot C - Control

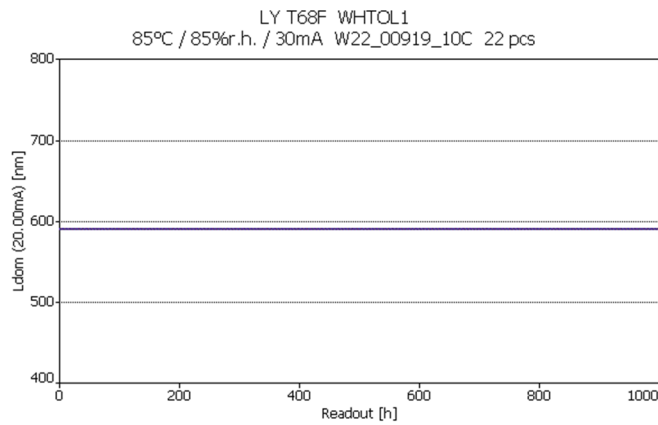
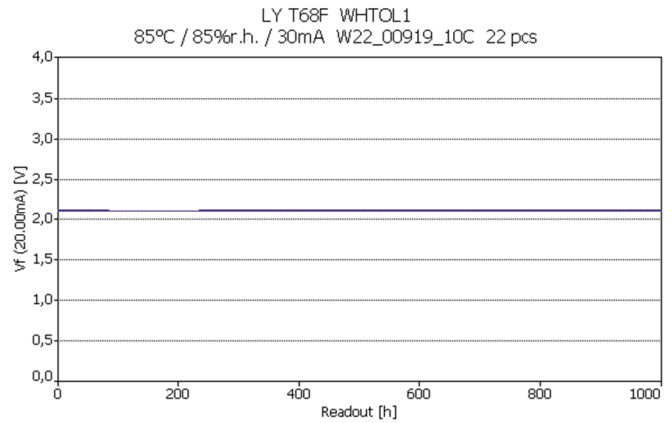
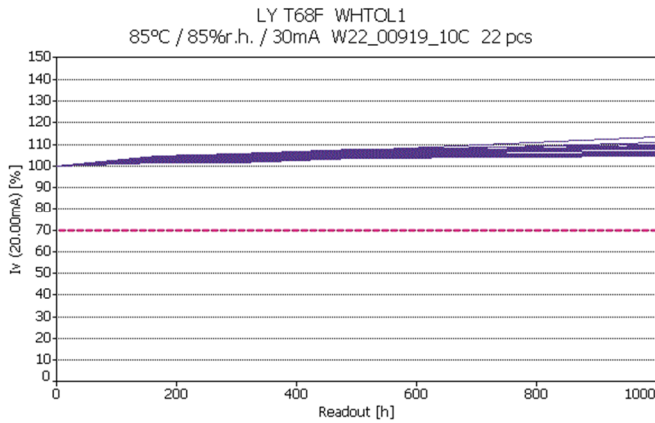

WHTOL1 85°C/85%r.H; 30mA

LR T68F

Lot D

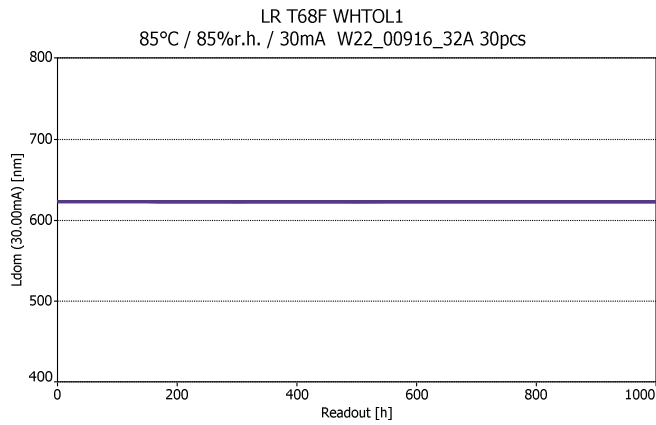
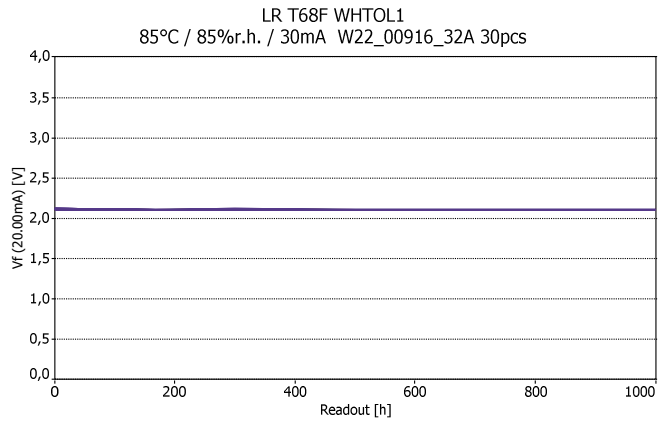
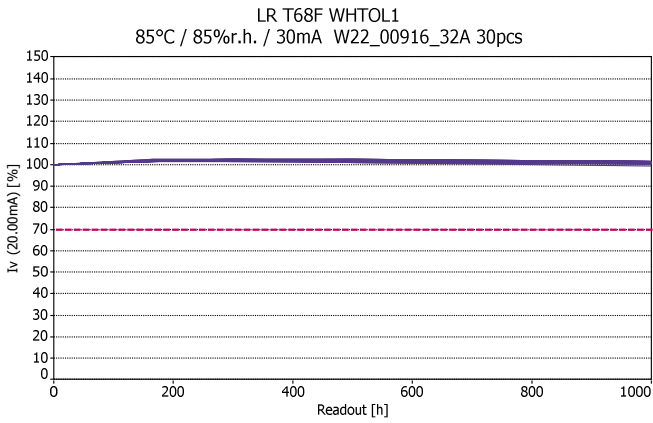

WHTOL1 85°C/85%r.H; 30mA

LR T68F

Lot E - Control

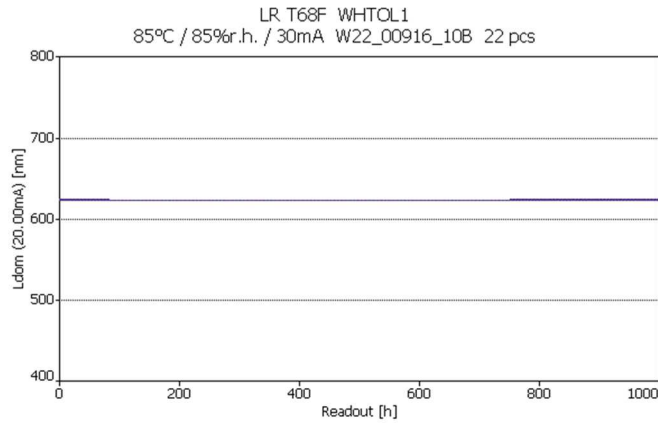
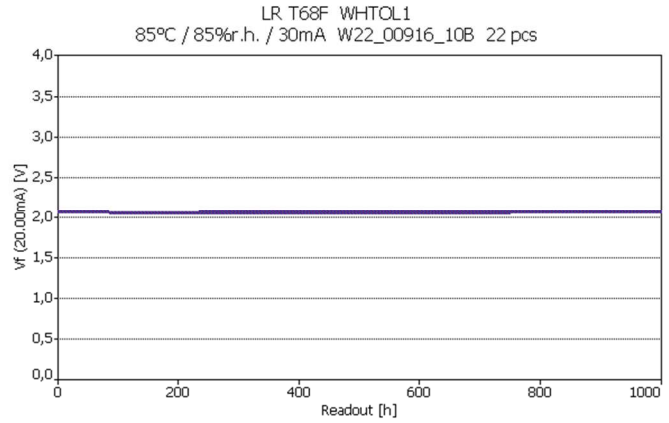
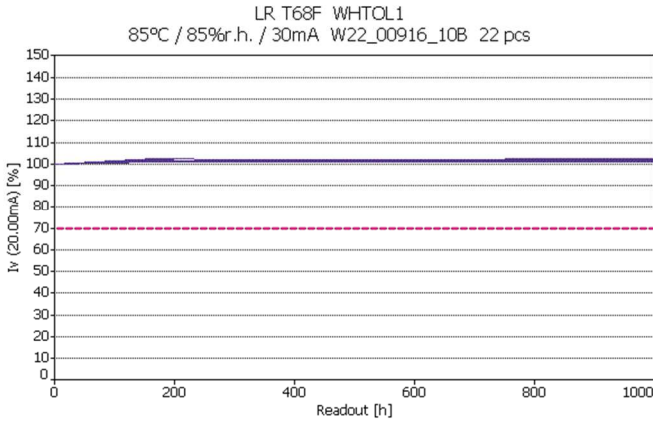

WHTOL2 85°C/85%r.H; 1mA

LY T68F

Lot A

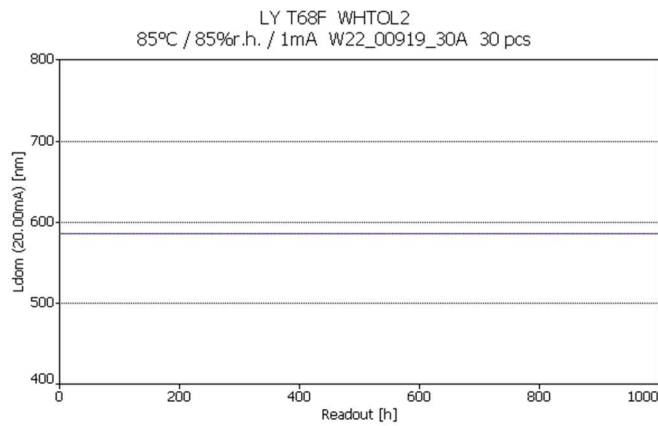
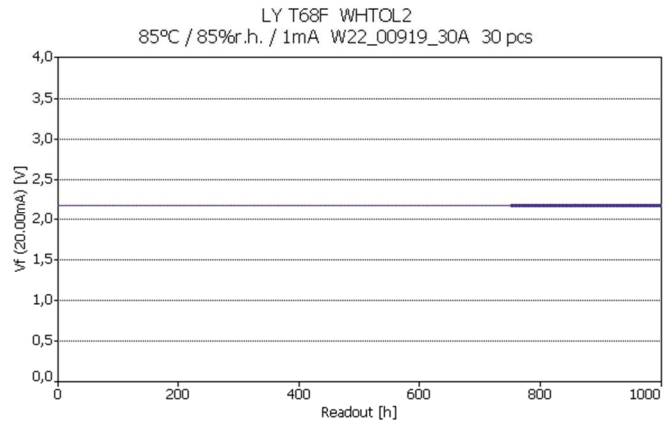
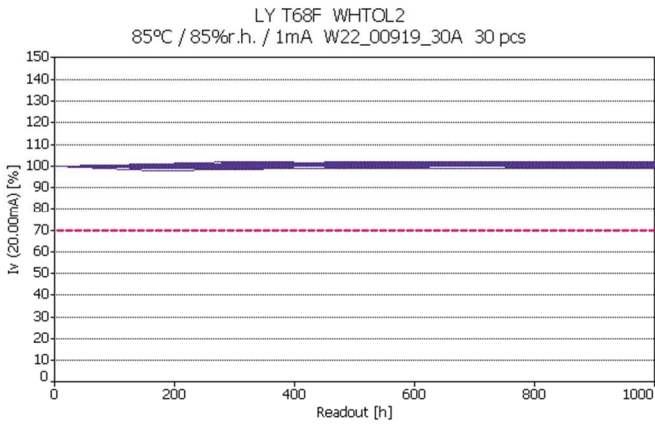

WHTOL2 85°C/85%r.H; 1mA

LY T68F

Lot B

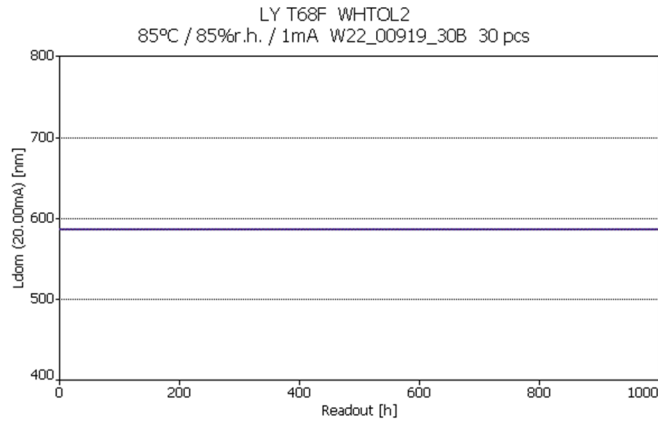
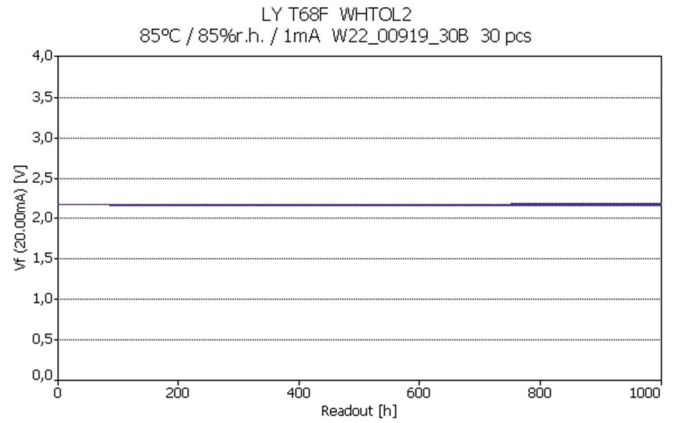
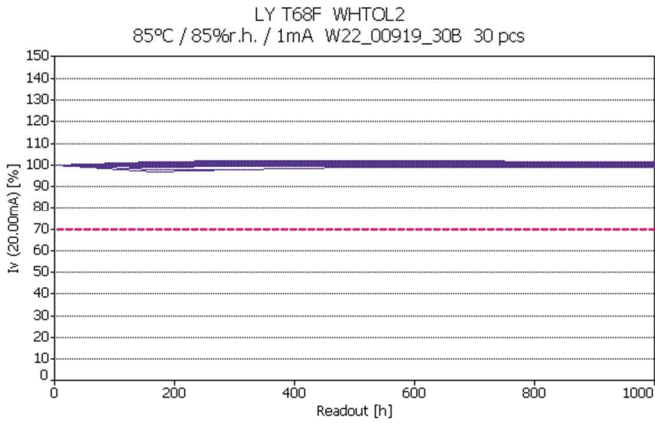

WHTOL2 85°C/85%r.H; 1mA

LY T68F

Lot C - Control

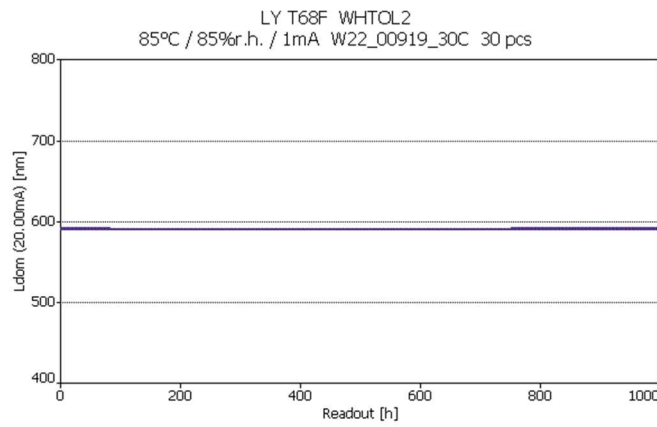
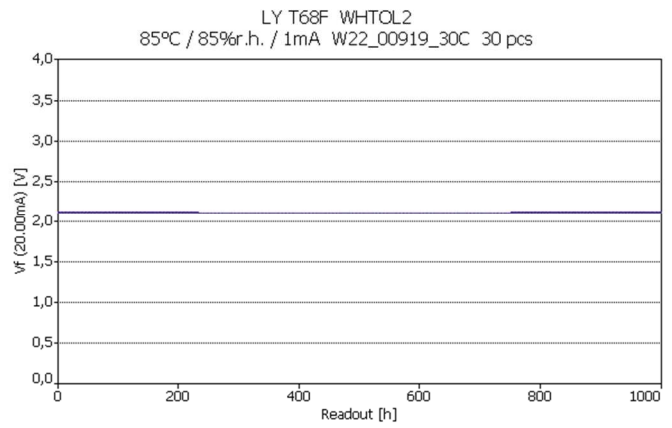
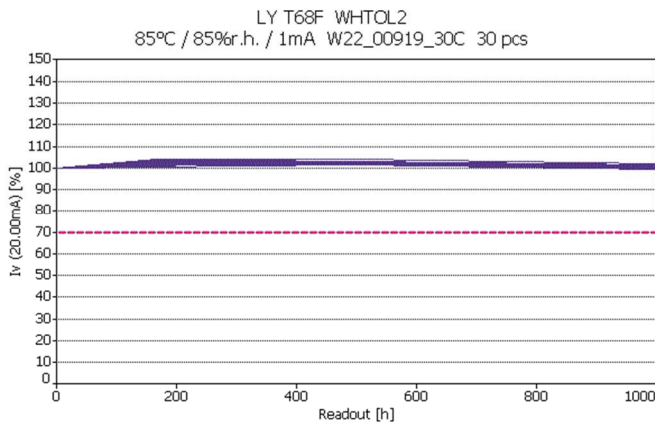

WHTOL2 85°C/85%r.H; 1mA

LR T68F

Lot D

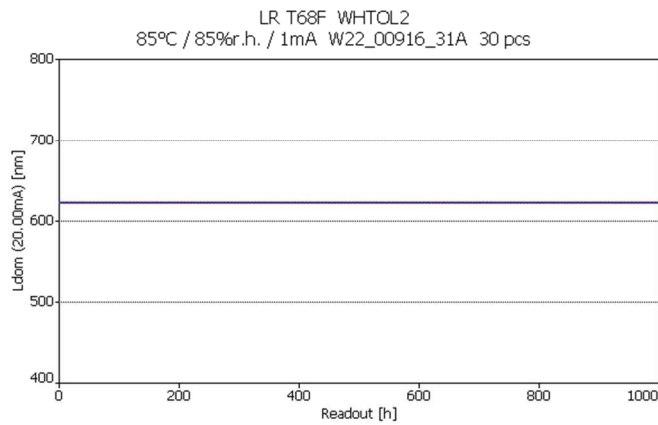
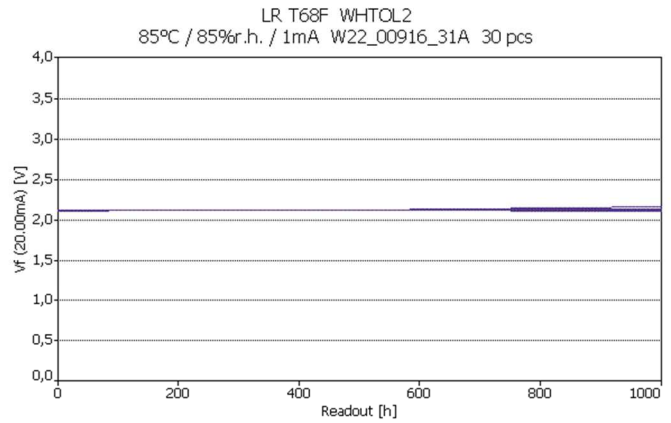
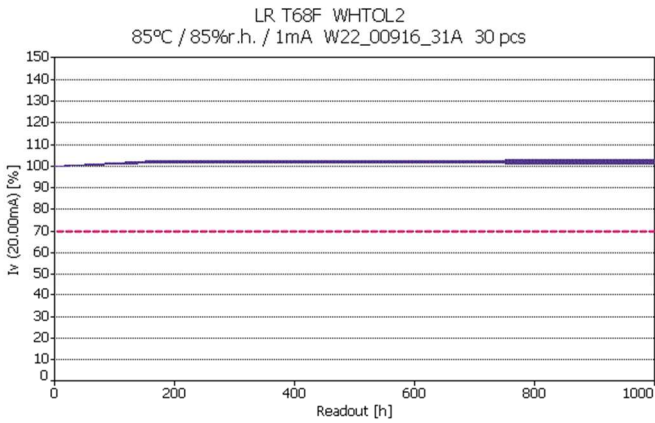

WHTOL2 85°C/85%r.H; 1mA

LR T68F

Lot E - Control

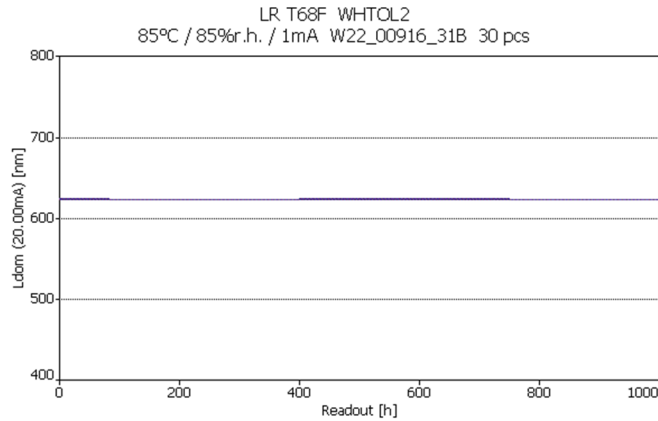
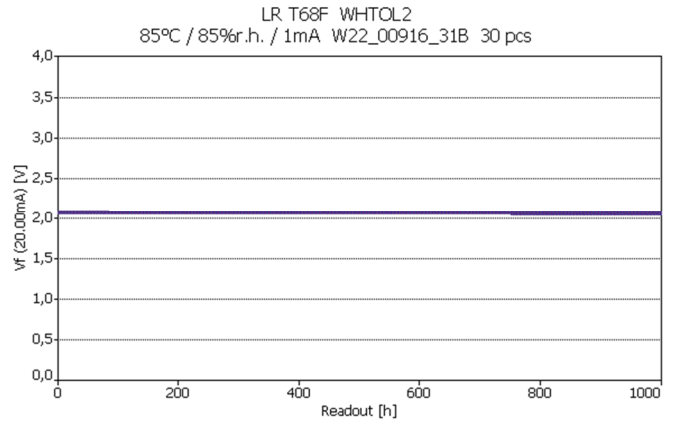
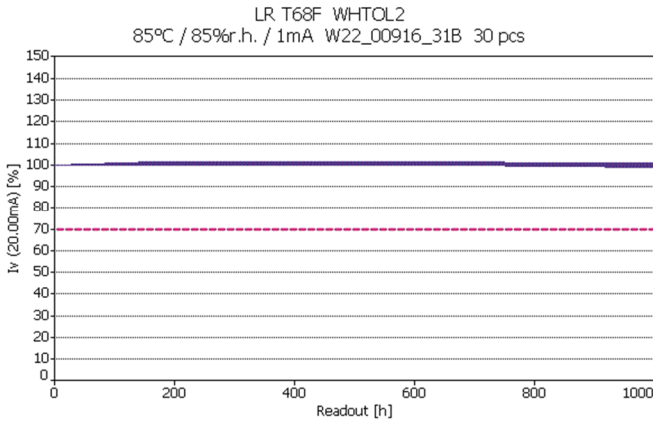

TC -40°C/100°C

LY T68F

Lot A

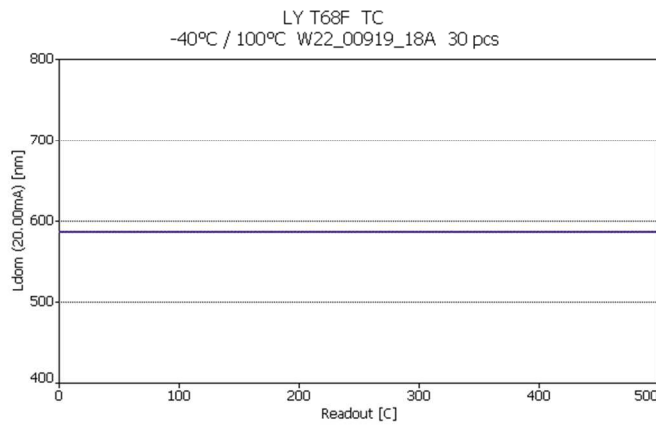
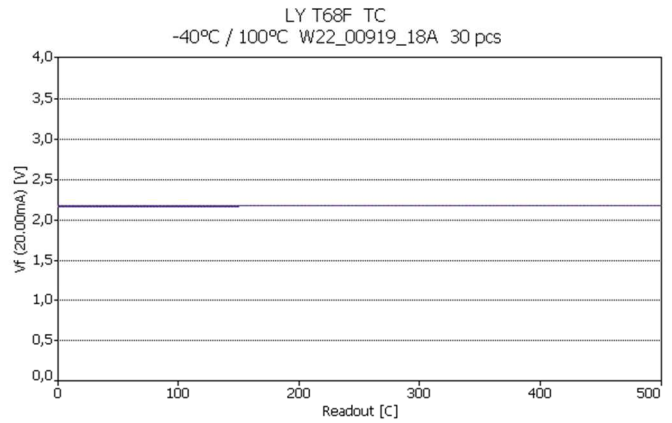
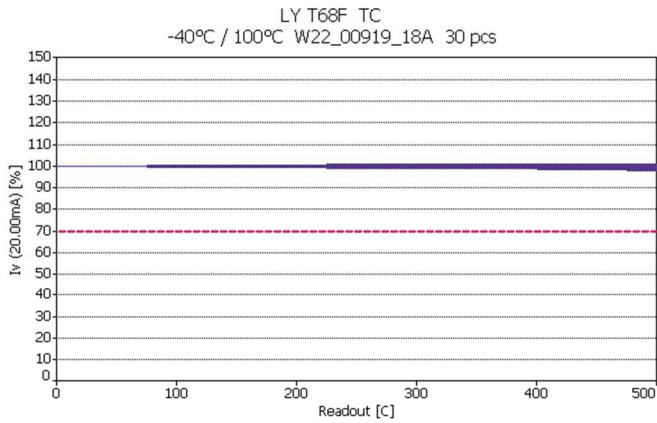

TC -40°C/100°C

LY T68F

Lot B

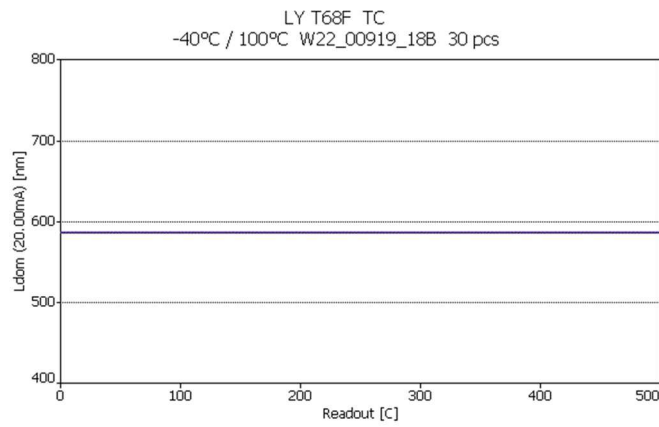
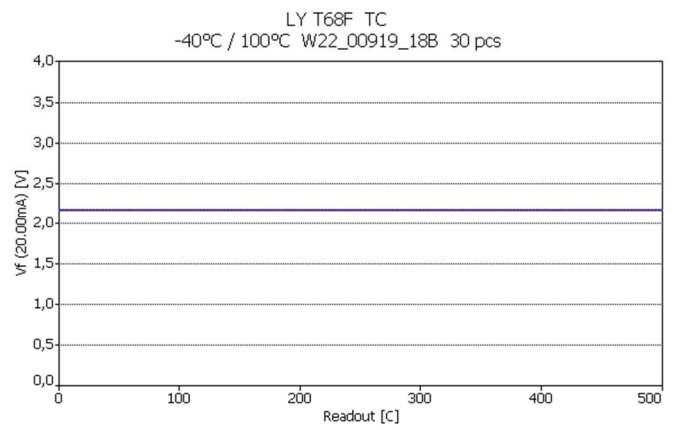
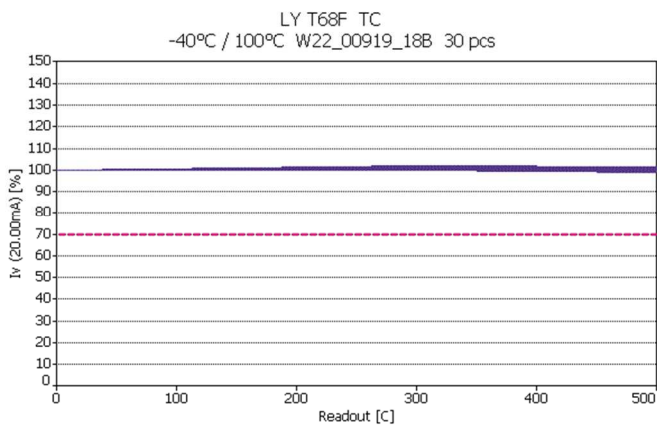

TC -40°C/100°C

LY T68F

Lot C - Control

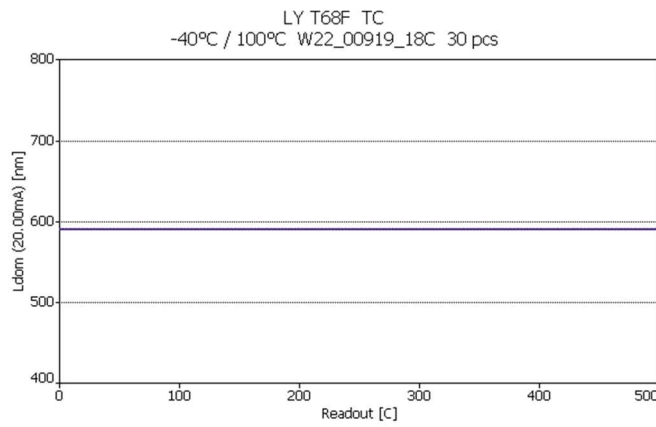
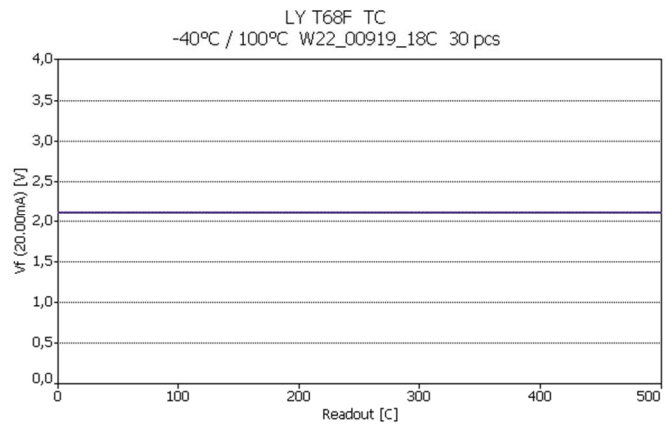
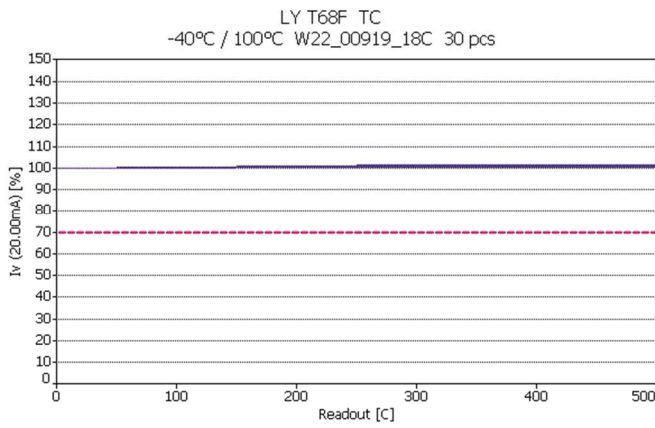

TC -40°C/100°C

LR T68F

Lot D

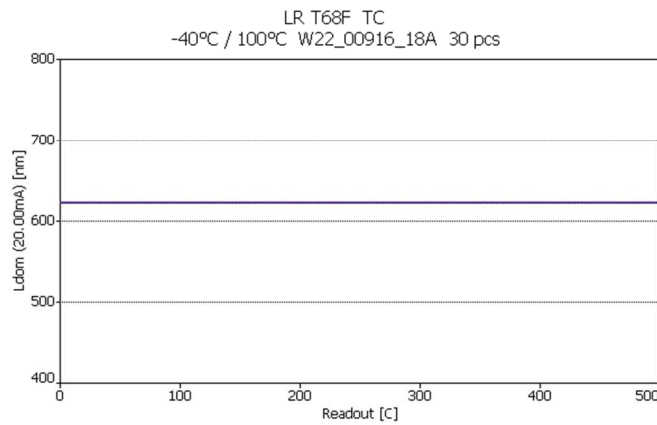
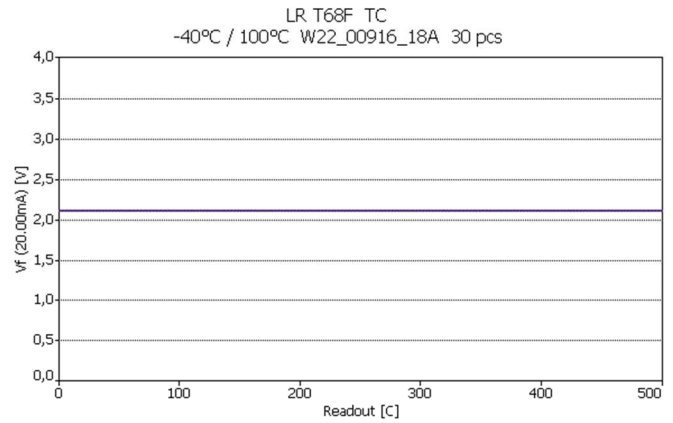
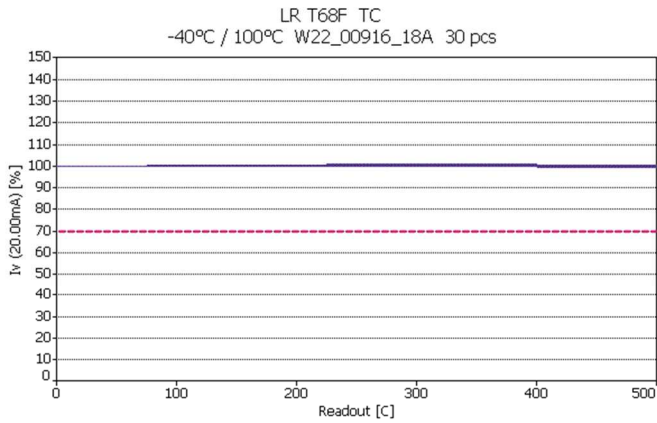

TC -40°C/100°C

LR T68F

Lot E - Control

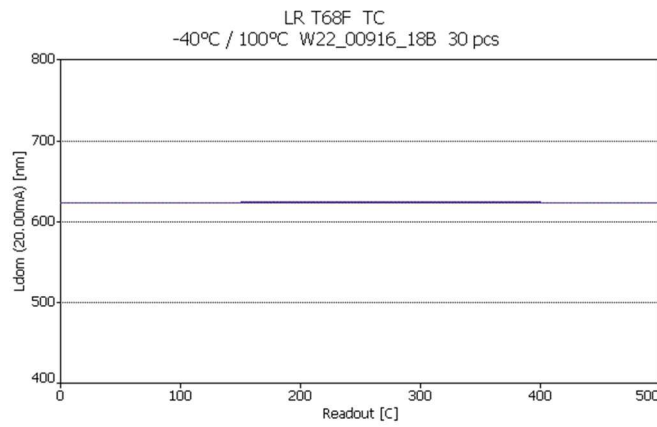
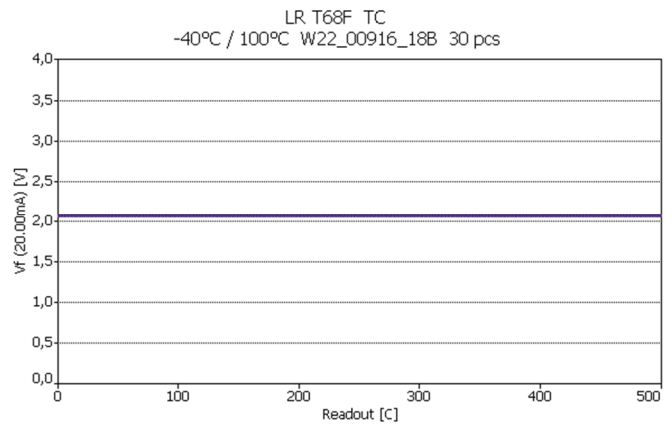
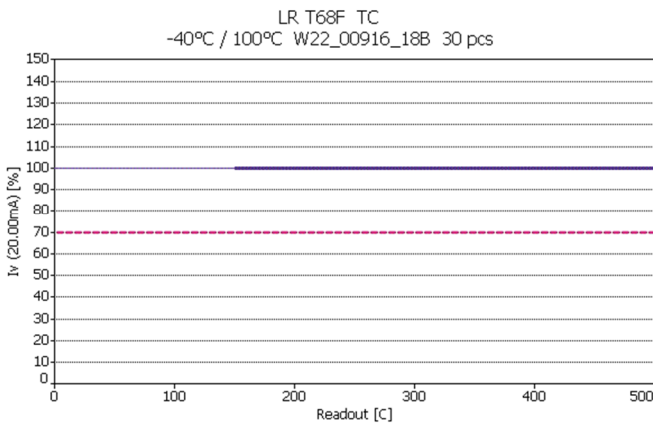

PTC -40°C/100°C; 30mA

LY T68F

Lot A

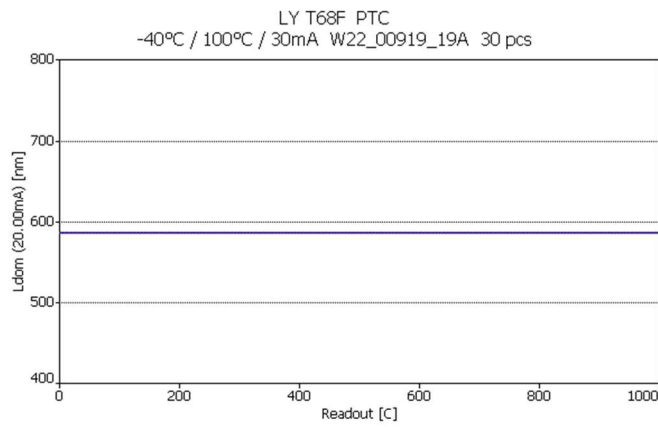
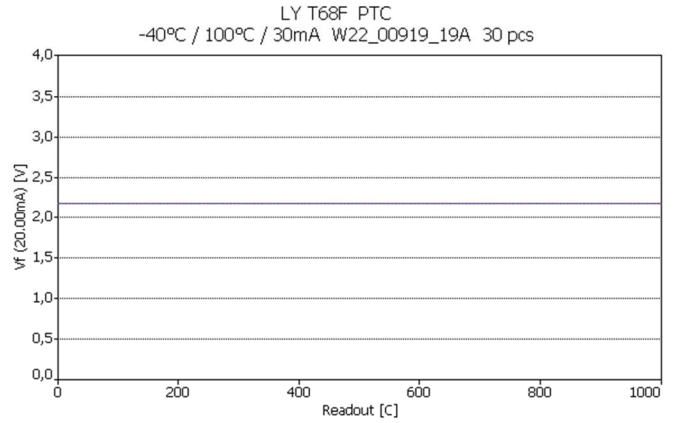
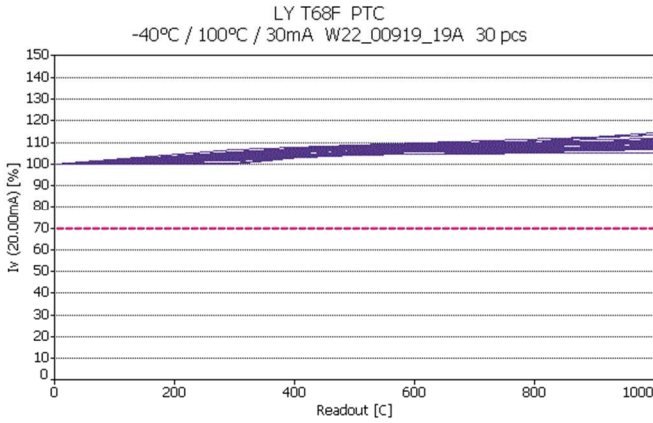

PTC -40°C/100°C; 30mA

LY T68F

Lot B

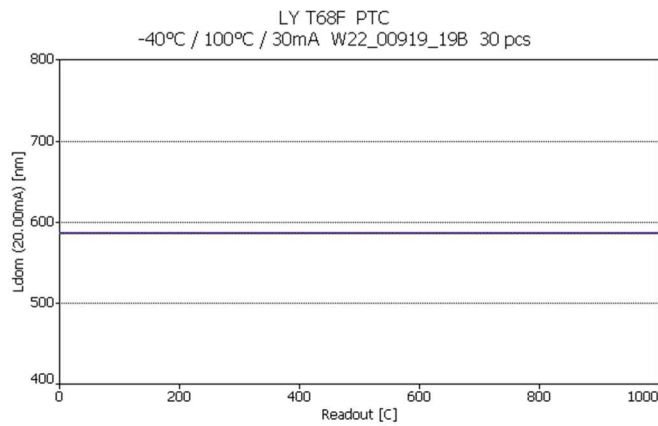
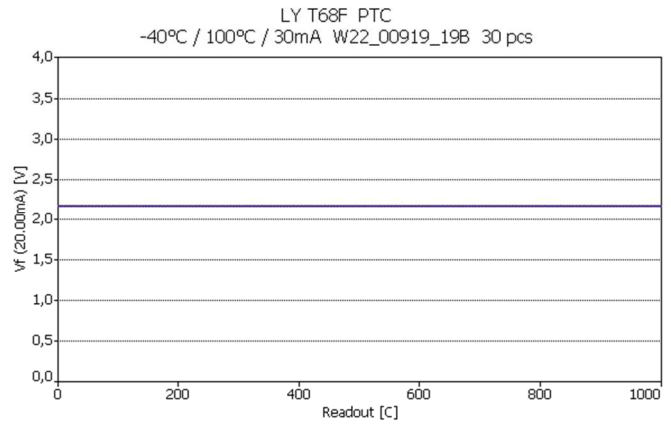
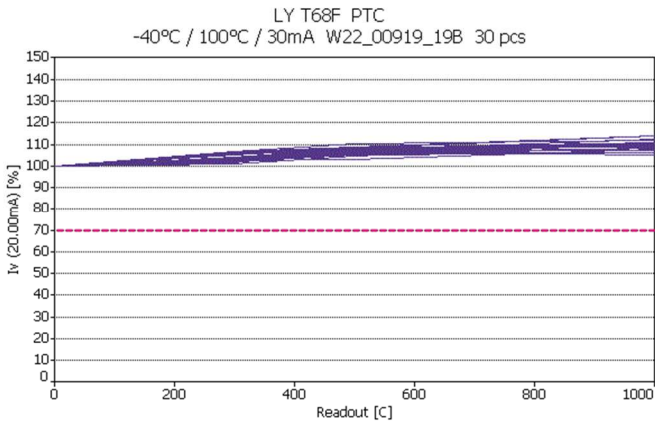

PTC -40°C/100°C; 30mA

LY T68F

Lot C - Control

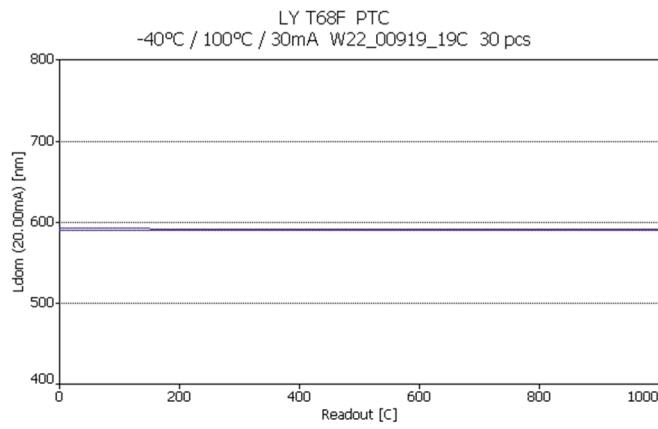
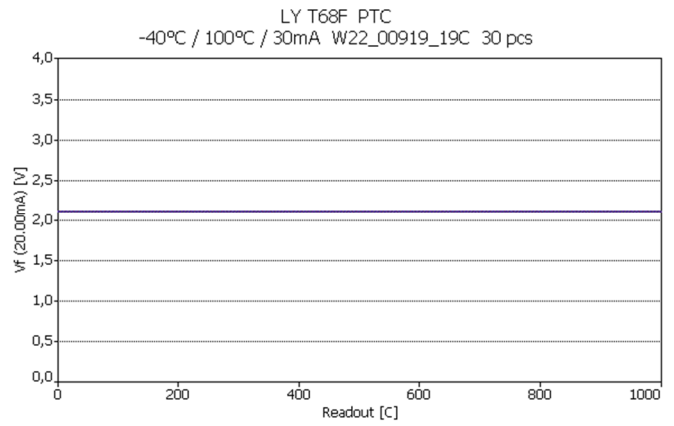
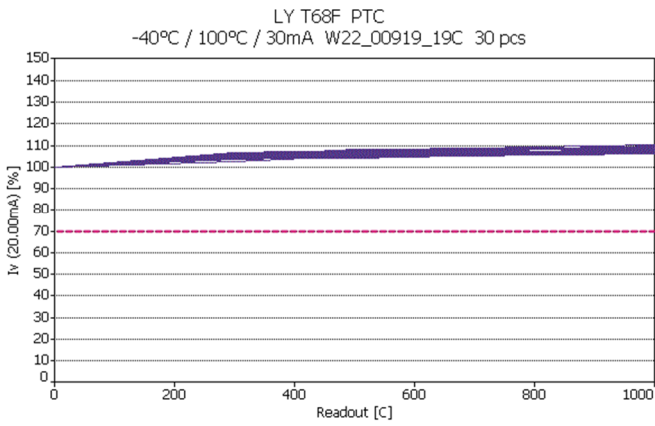

PTC -40°C/100°C; 30mA

LR T68F

Lot D

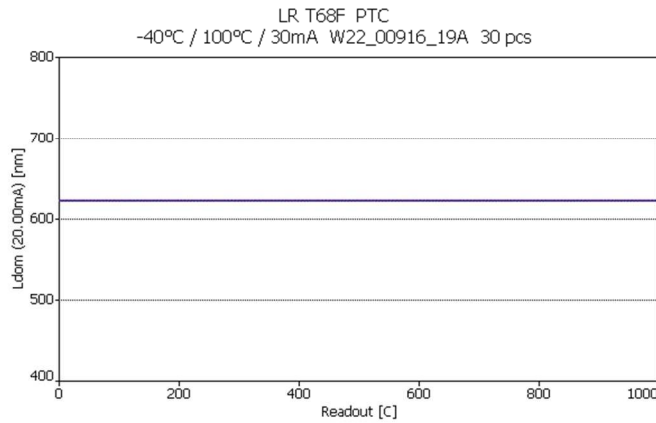
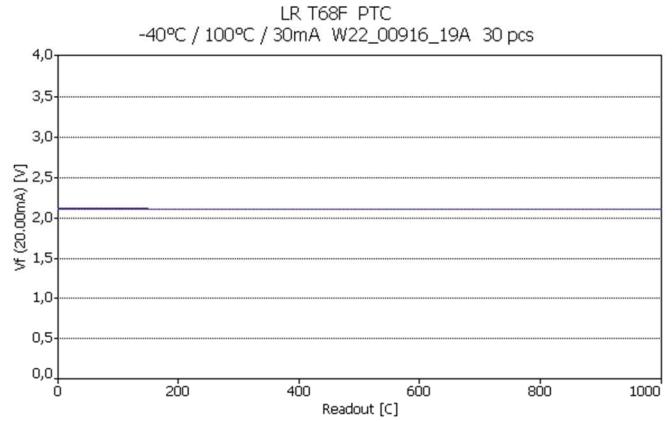
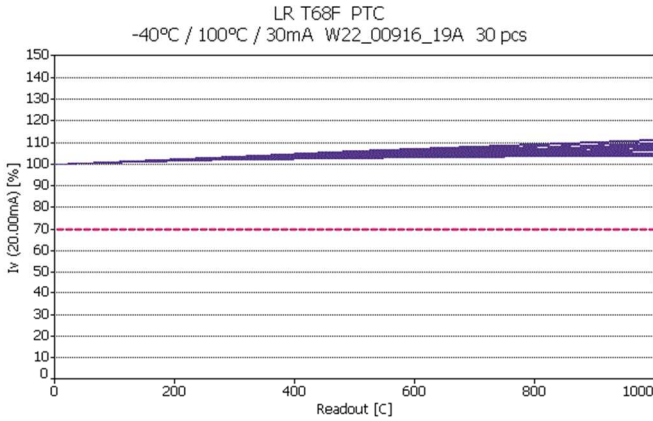

PTC -40°C/100°C; 30mA

LR T68F

Lot E - Control

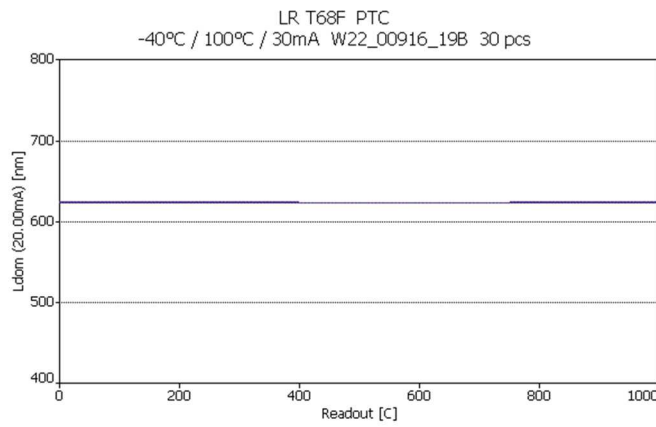
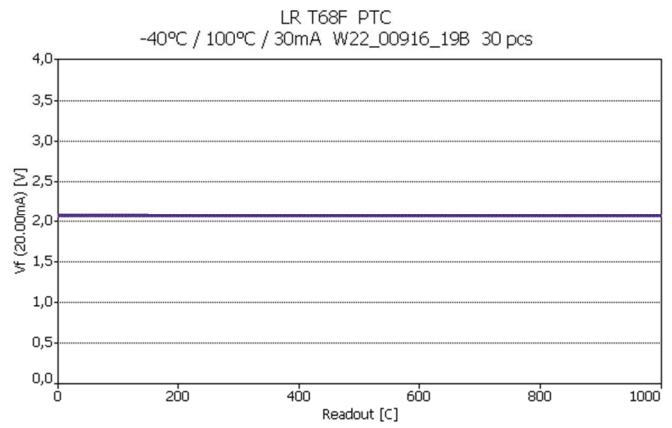
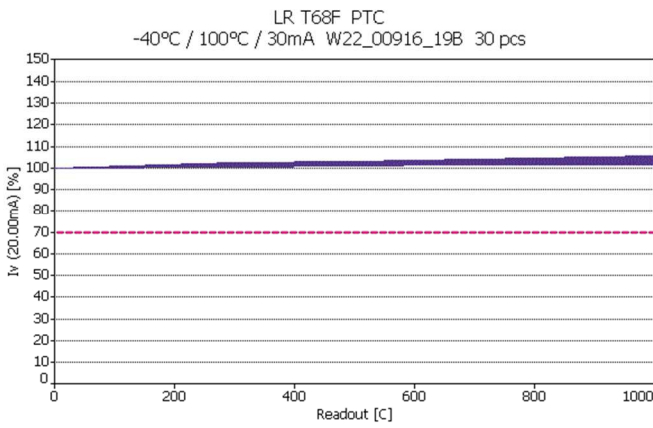

PLT 25°C/80mA;tp=0,1ms; D=3%

LY T68F

Lot A

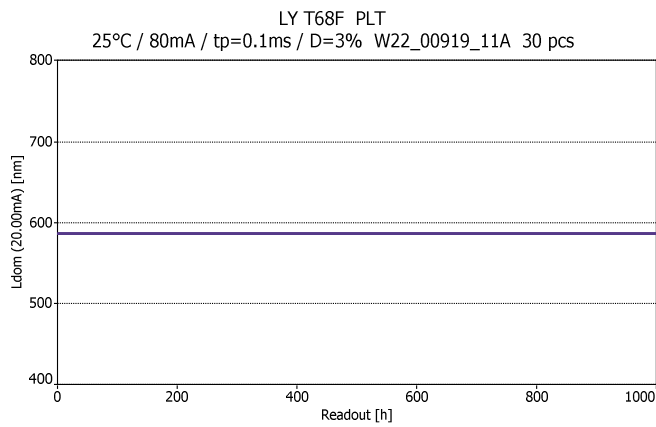
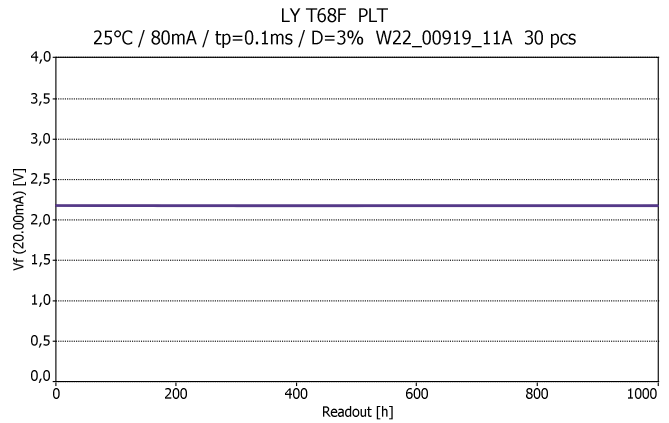
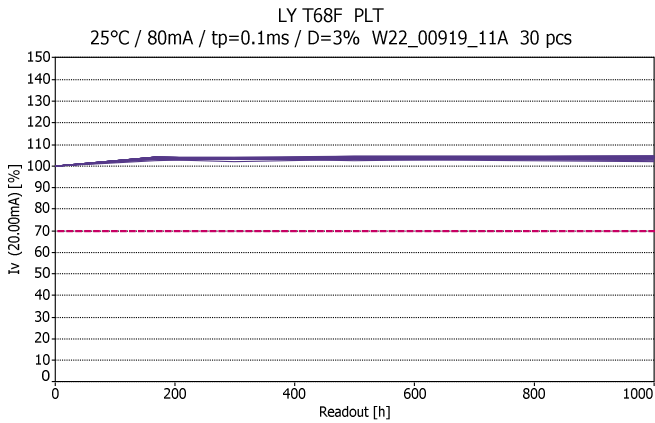

PLT 25°C/80mA;tp=0,1ms; D=3%

LY T68F

Lot B

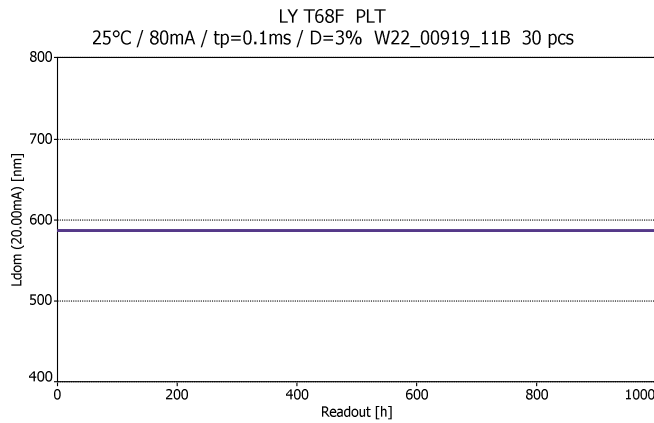
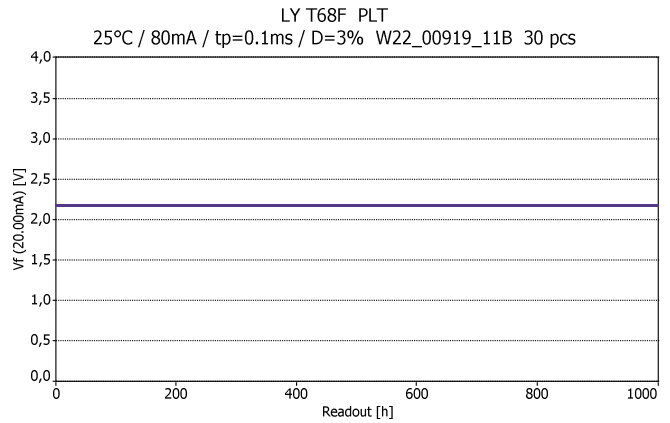
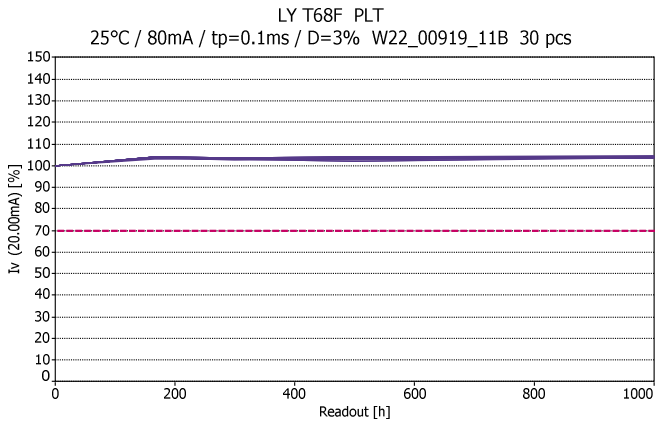

PLT 25°C/80mA;tp=0,1ms; D=3%

LY T68F

Lot C - Control

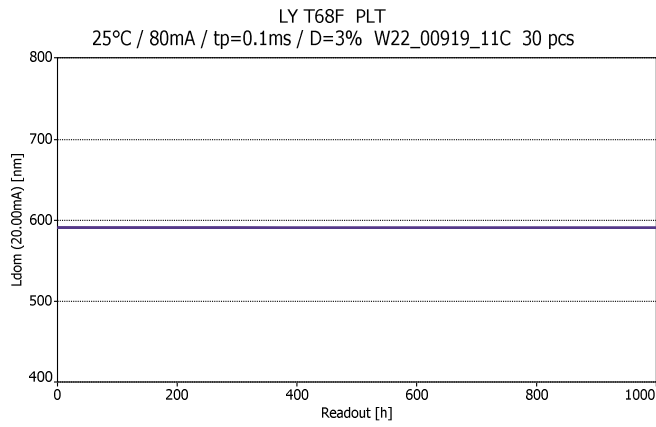
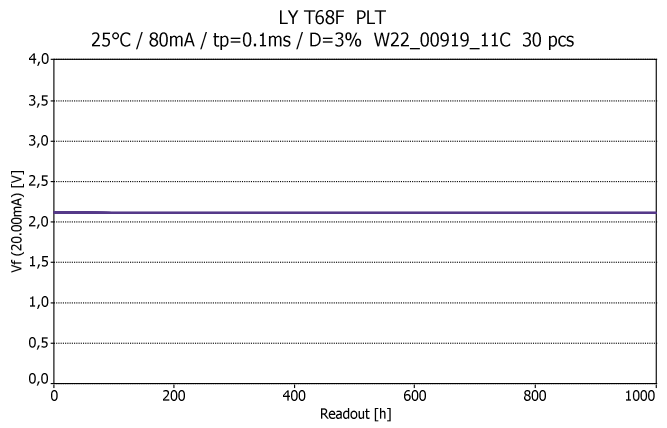
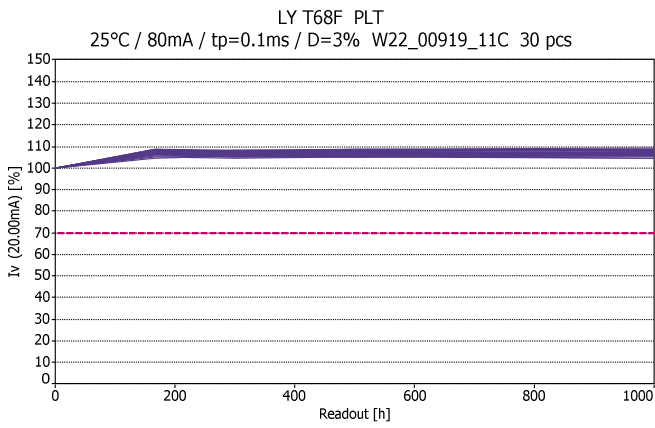

PLT 25°C/80mA;tp=0,1ms; D=3%

LR T68F

Lot D

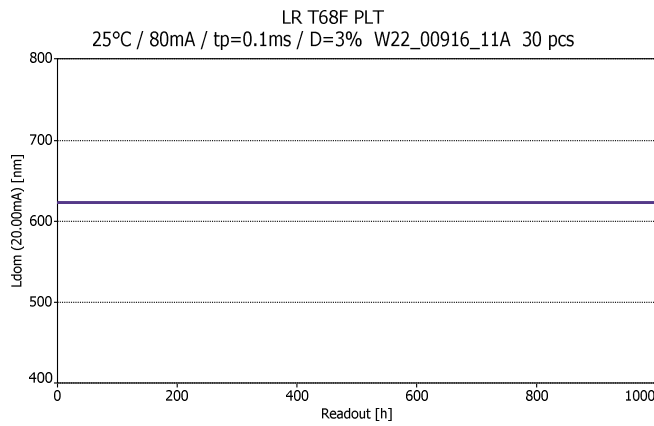
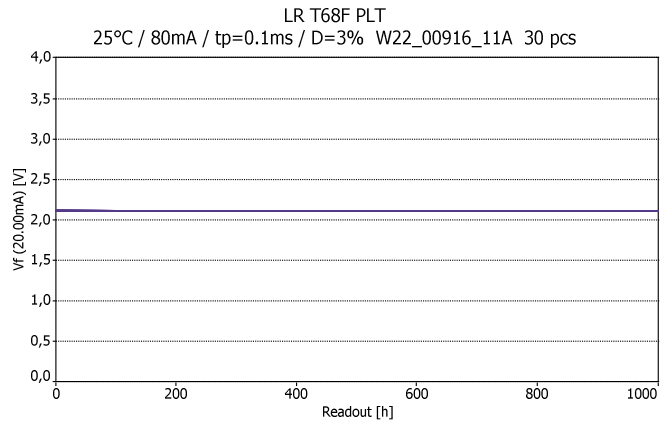
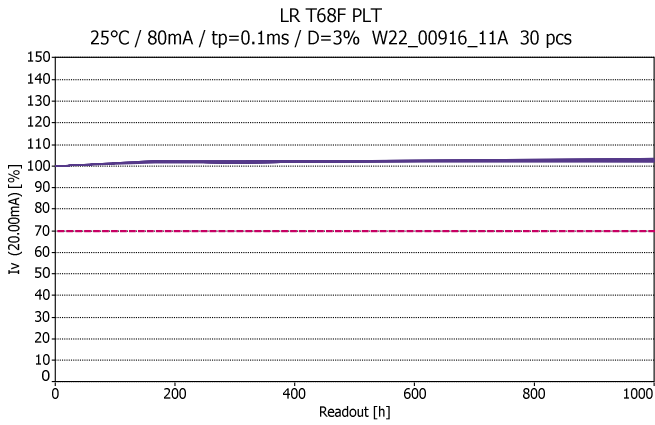

PLT 25°C/80mA;tp=0,1ms; D=3%

LR T68F

Lot E - Control

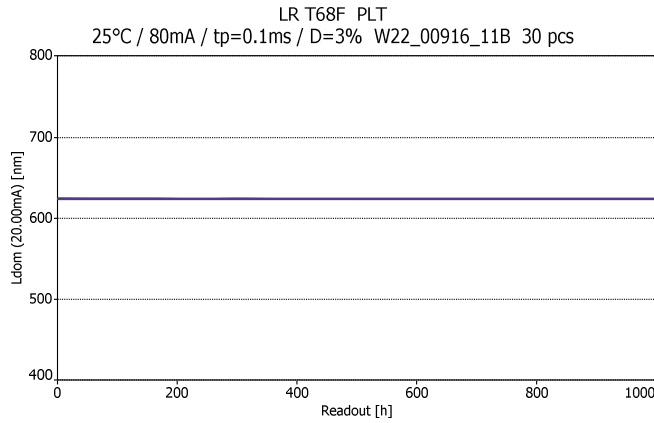
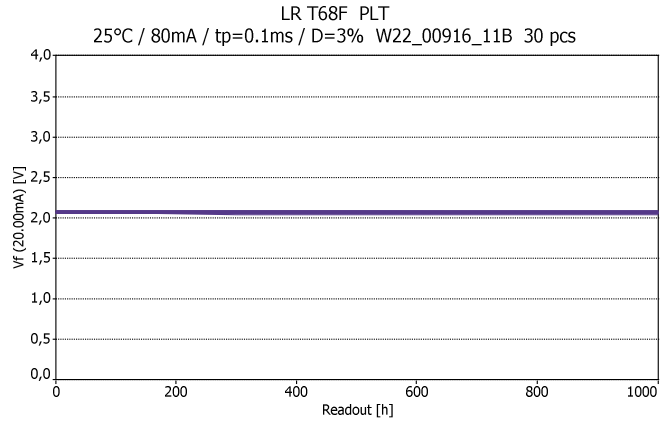
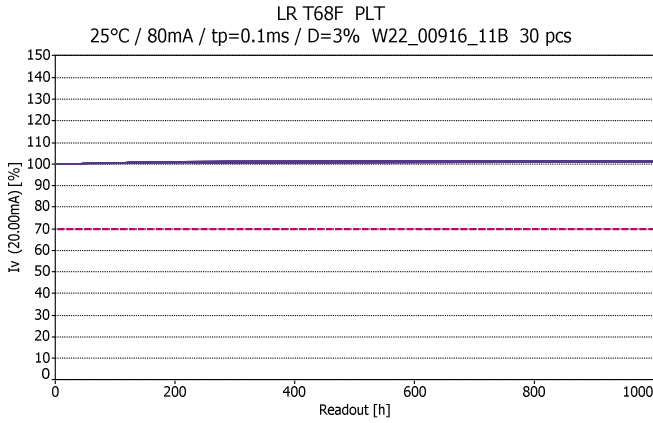

HTOL1 85°C/30mA

LY T68F

Lot A

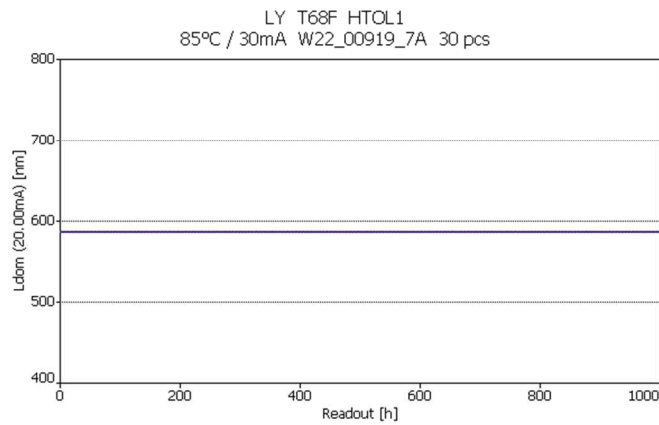
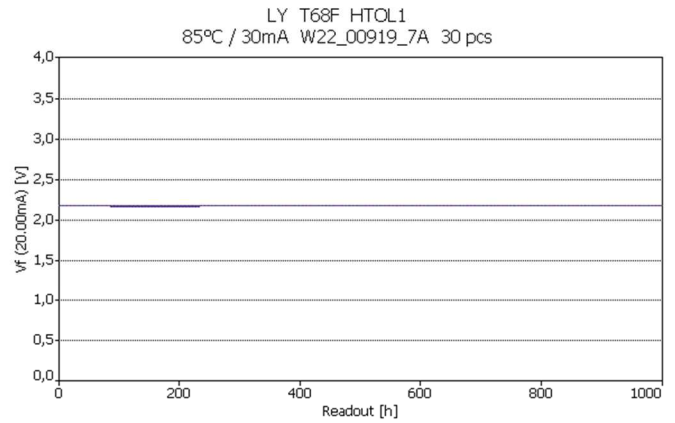
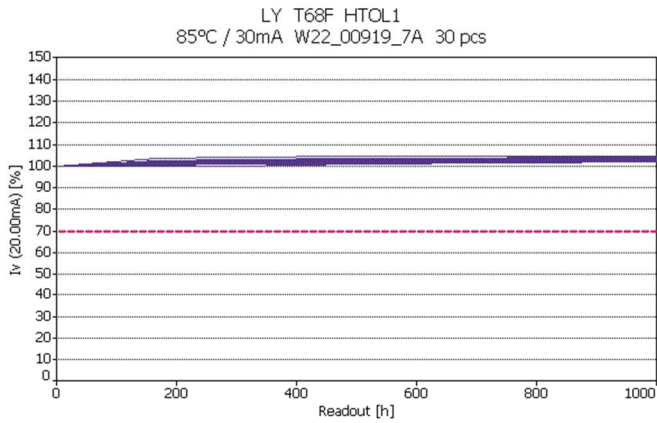

HTOL1 85°C/30mA

LY T68F

Lot B

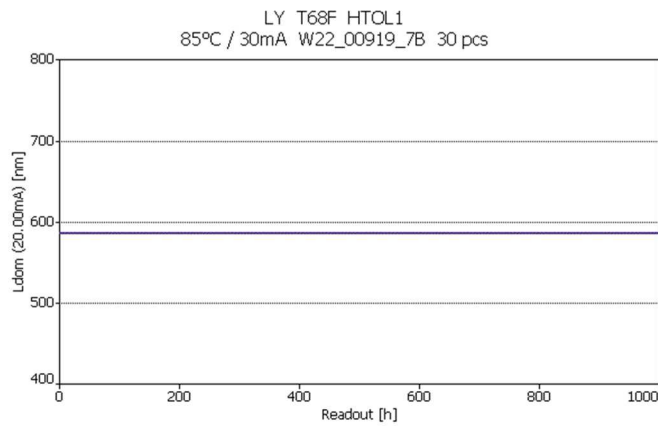
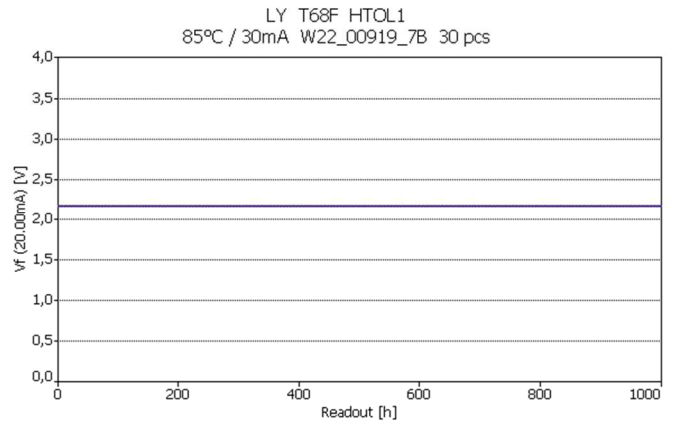
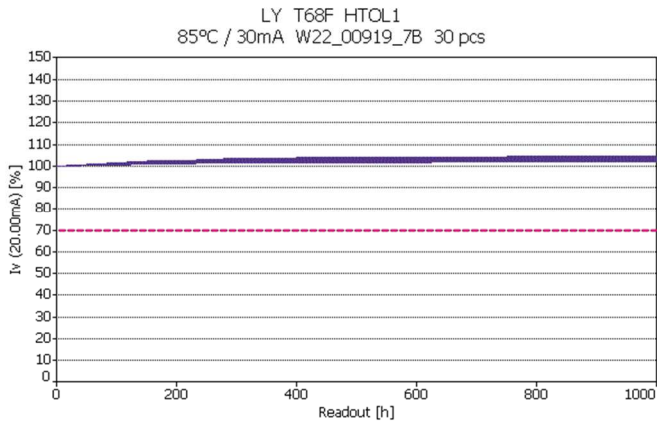

HTOL1 85°C/30mA

LY T68F

Lot C - Control

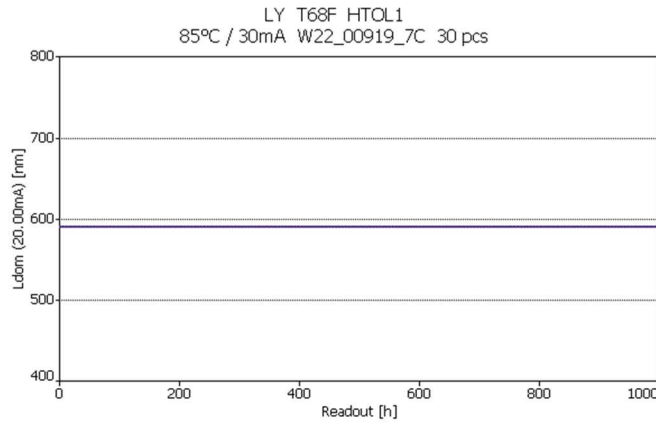
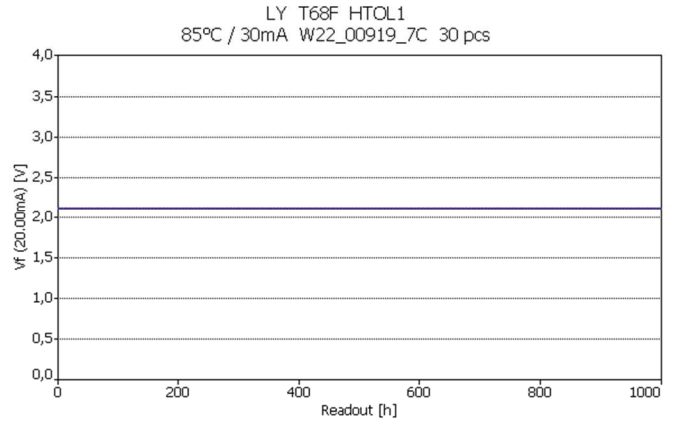
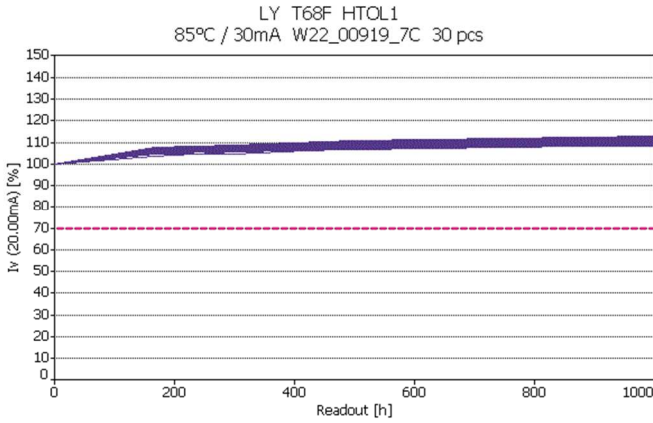

HTOL1 85°C/30mA

LR T68F

Lot D

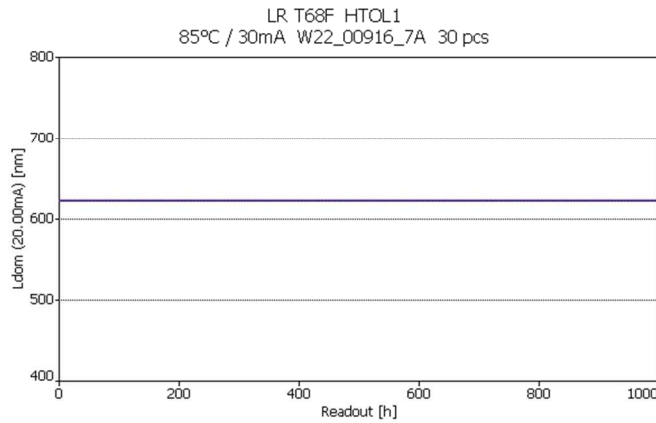
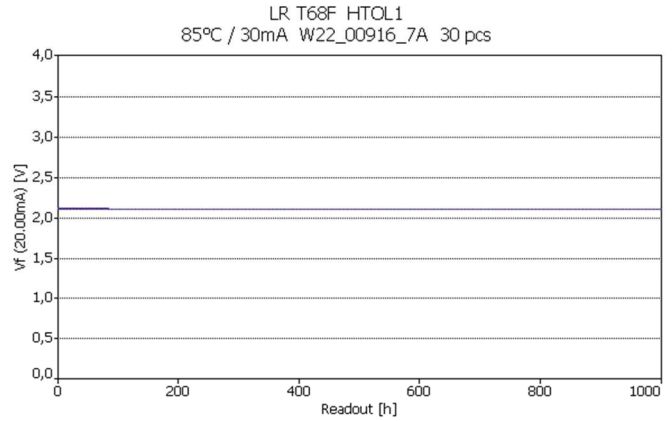
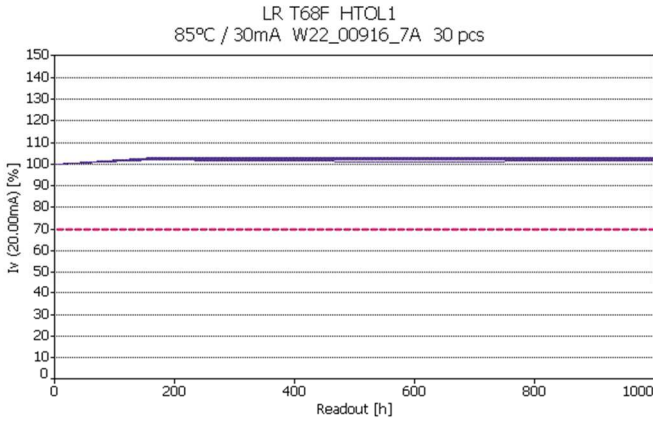

HTOL1 85°C/30mA

LR T68F

Lot E - Control

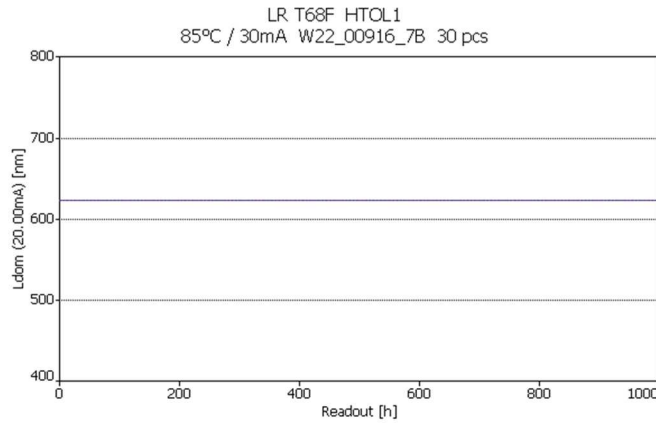
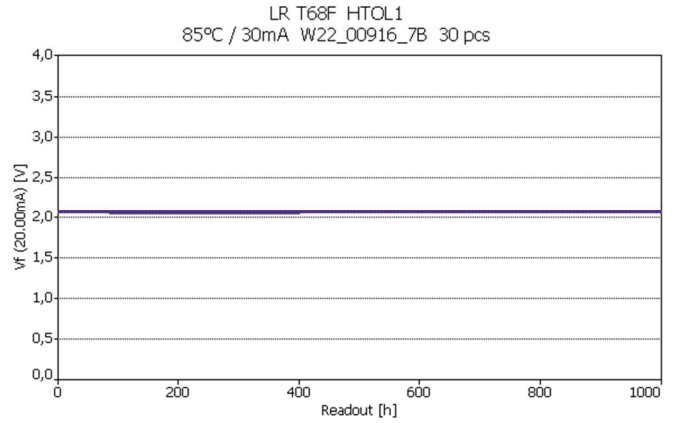
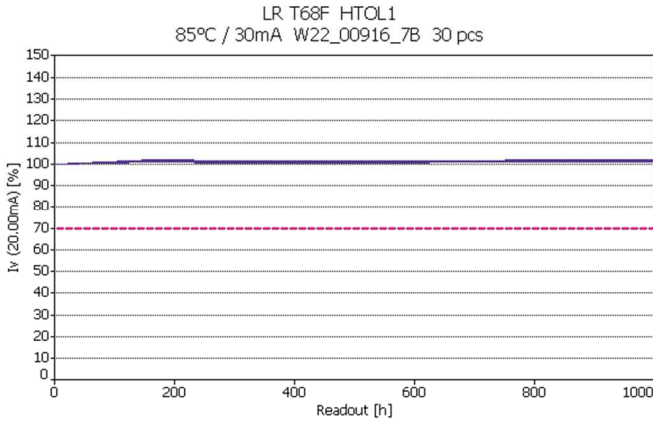

HTOL2 25°C/50mA

LY T68F

Lot A

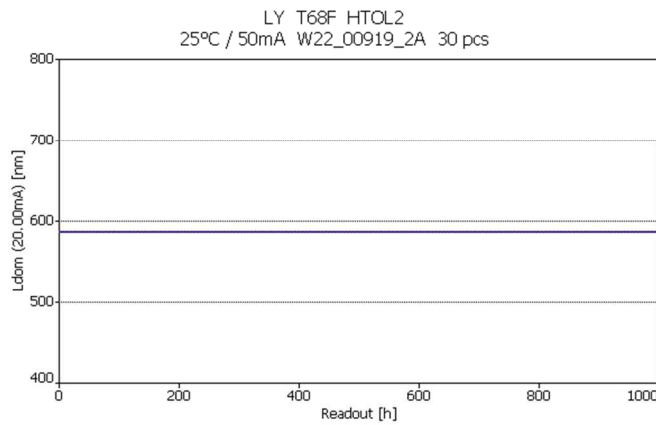
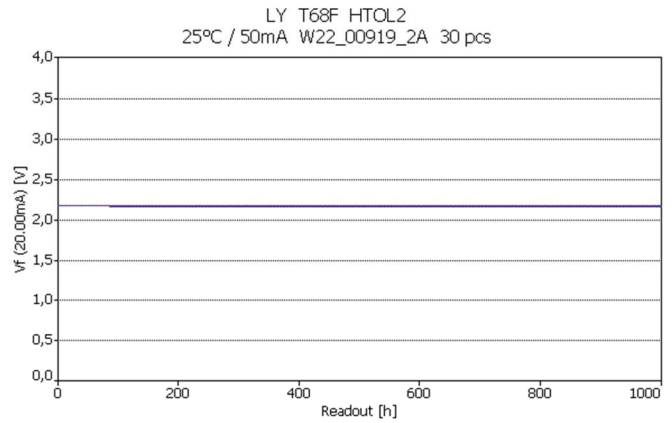
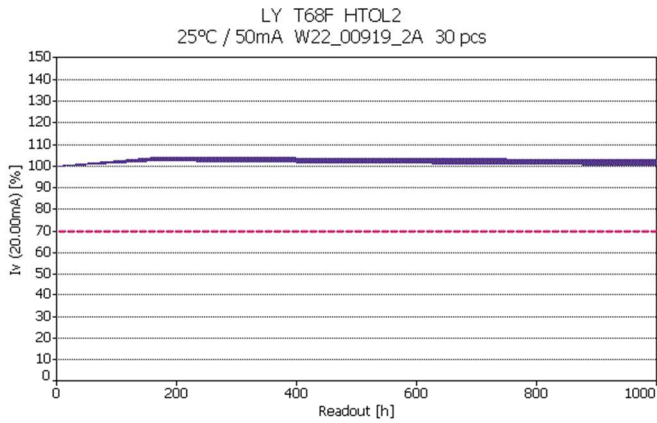

HTOL2 25°C/50mA

LY T68F

Lot B

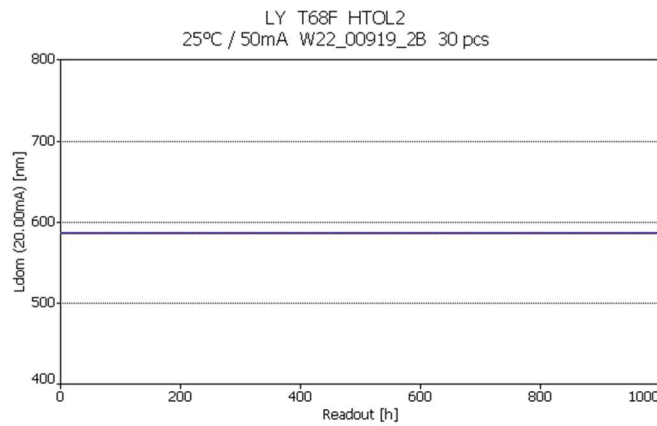
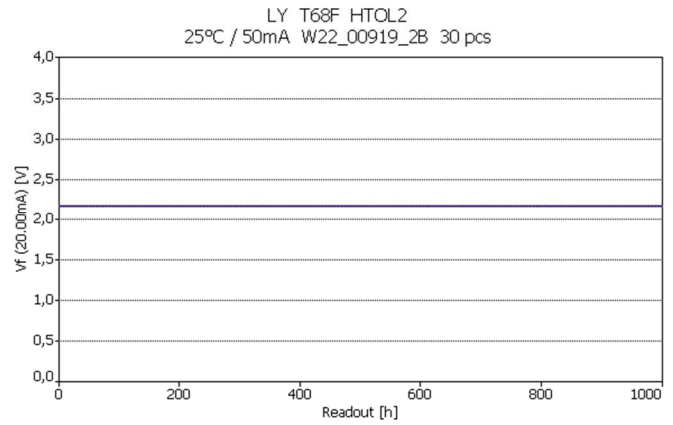
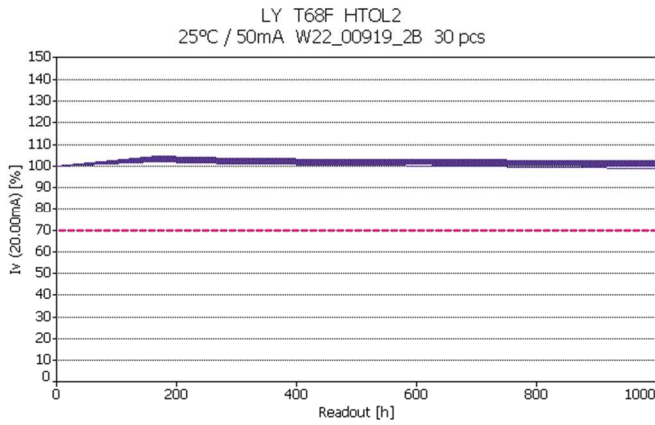

HTOL2 25°C/50mA

LY T68F

Lot C - Control

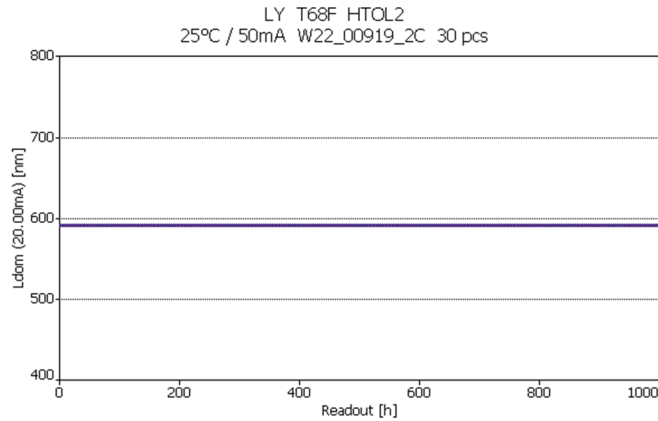
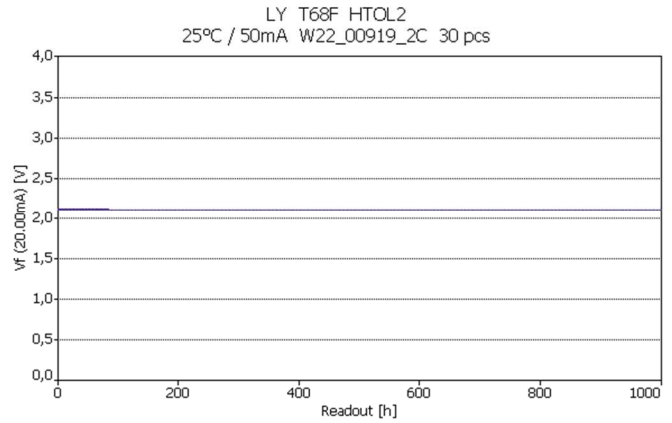
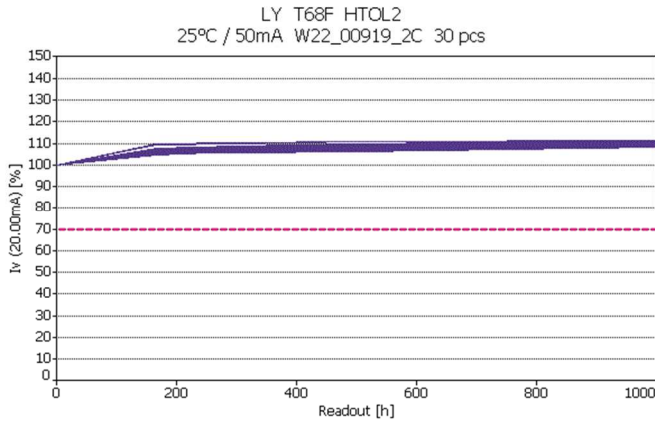

HTOL2 25°C/50mA

LR T68F

Lot D

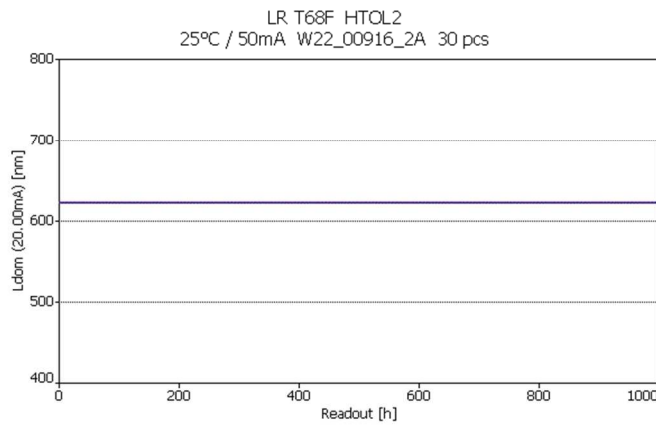
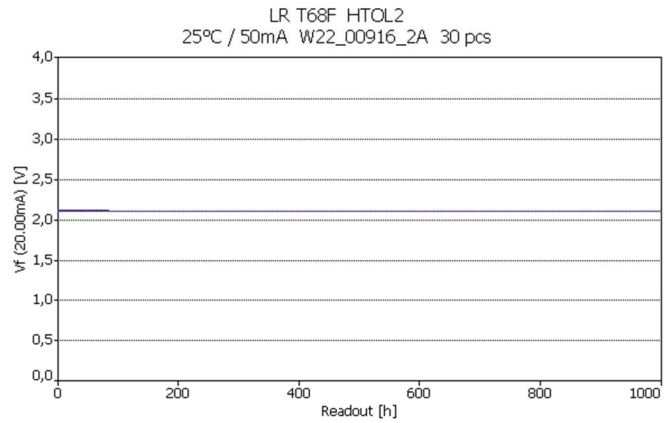
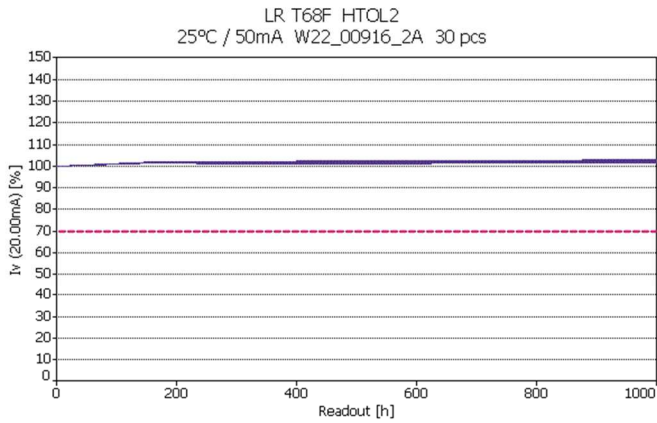

HTOL2 25°C/50mA

LR T68F

Lot E - Control

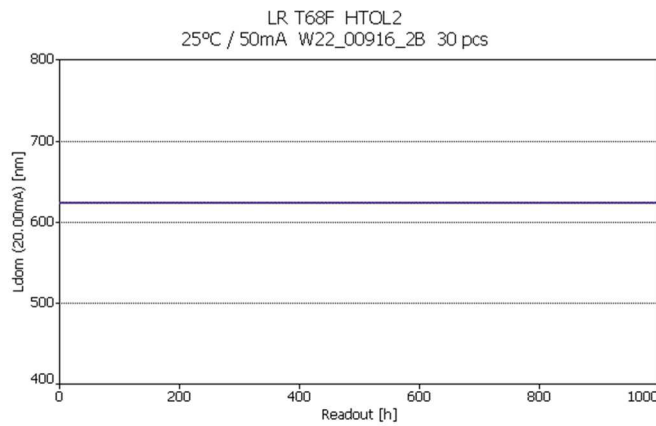
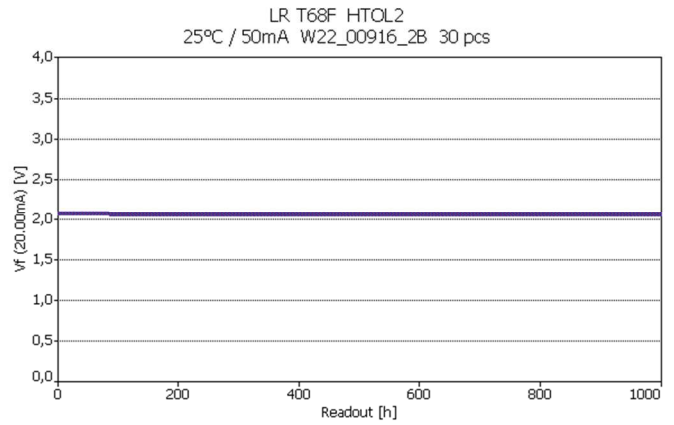
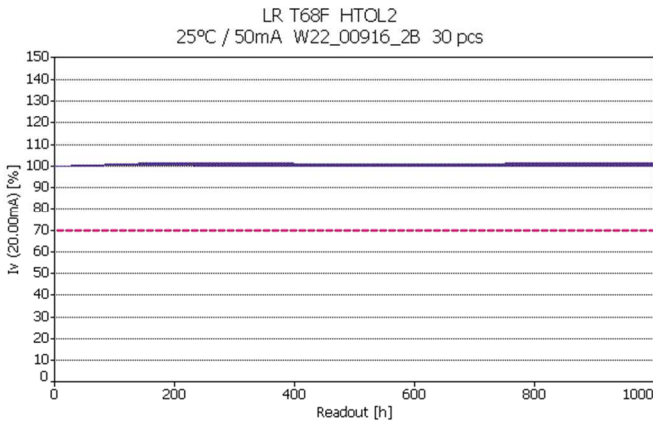

END OF DOCUMENT