

UM11524

First Field Verification Tool User manual

Rev. 1 — 24 February 2021

User manual

Document information

Information	Content
Keywords	SEN-SPI-BOX, FFV Tool
Abstract	FFV Tool User manual



Revision history

Rev	Date	Description
1	20210224	<ul style="list-style-type: none">Initial release

1 Introduction

This document describes how to use the SEN-SPI-BOX kit for NXP automotive sensor evaluation with the “NXP First Field Verification Tool” software.

The intent of this document is to get started, from the hardware configuration to the software manipulation, in order to communicate with NXP sensors and get interactive data.



Figure 1. NXP Sensor SPI/I²C Master Kit - SEN-SPI-BOX

2 Getting started

2.1 Kit contents/packing list

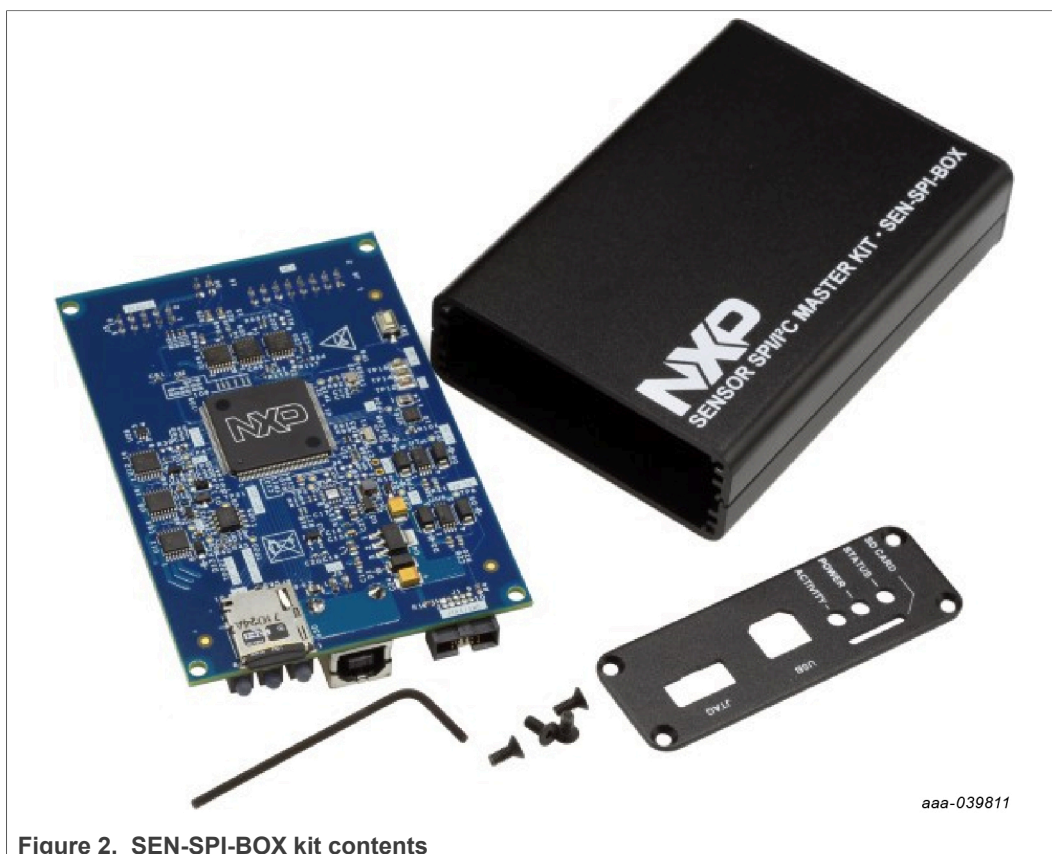

Figure 2. SEN-SPI-BOX kit contents

The SEN-SPI-BOX evaluation board contains:

- One Sensor SPI Master Kit (SEN-SPI-BOX)
- One USB Type A USB cable
- One NXP MDI ribbon cable (16-pin)
- One Beagle ribbon cable (10-pin)
- One debug cable
- One 8 GB microSD card
- One microSD to PC adapter

If DSI3 or PSI5 protocol is required, a SEN-DSI3-ADAPTER and a SEN-PSI5-ADAPTER may be ordered separately.

SEN-xxxx-ADAPTER kit contains:

- One SEN-xxxx-ADAPTER
- Two, 2-wire twisted cables

2.2 Finding kit resources and information on the NXP website

NXP Semiconductors provides online resources for this evaluation board and supported devices on <http://www.nxp.com>. The information page for the SEN-SPI-BOX evaluation board is at <http://nxp.com/SEN-SPI-BOX>. The information page provides overview information, documentation, software and tools, parametrics, ordering information and a Getting Started tab. The Getting Started tab provides quick-reference information applicable to using the SEN-SPI-BOX evaluation board, including the downloadable assets referenced in this document.

3 Hardware description

The NXP SEN-SPI-BOX kit provides a full-solution of built-in functionalities to communicate with any SPI/I²C sensor. The kit graphs real-time data, executes custom scripts and verifies sensor status. The board is a generic SPI/I²C evaluation board, compatible with some of the NXP sensor families such as FXLS9xxxx automotive digital accelerometers. The list of compatible sensors is non-exhaustive and may evolve in the future.

[Figure 3](#) shows how to couple the SEN-SPI-BOX with a SEN-GEN6-SKT board for the FXLS9xxxx evaluation.

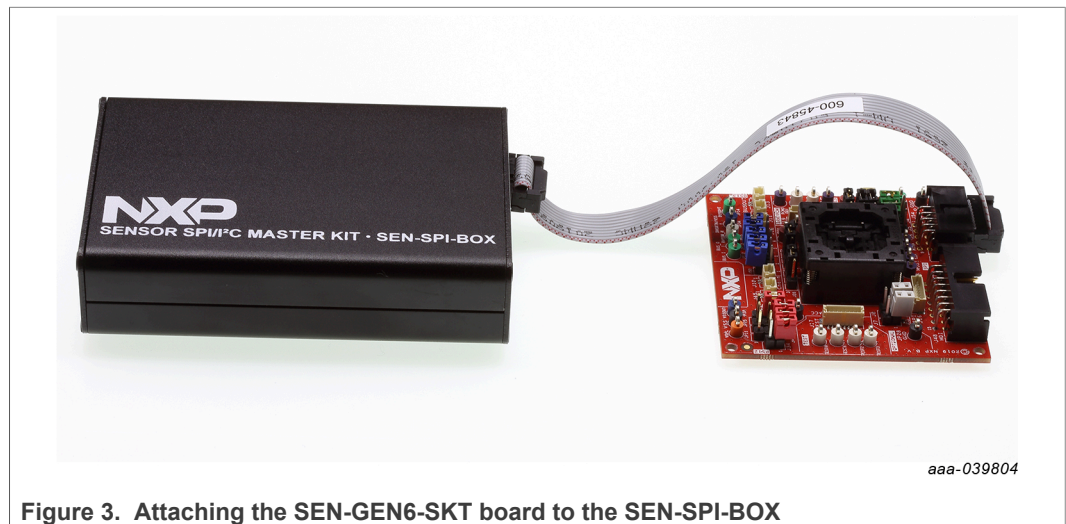

Figure 3. Attaching the SEN-GEN6-SKT board to the SEN-SPI-BOX

3.1 Kit overview

The kit contains an NXP SEN-SPI-BOX evaluation board, three different cables compatible with dedicated NXP sensor boards, a microSD card for built-in boot loading capability, and a USB Type-B cable to connect the kit to a computer.

The kit is powered by an NXP Kinetis® K64F Cortex M4 Microcontroller.



Figure 4. SEN-SPI-BOX overview

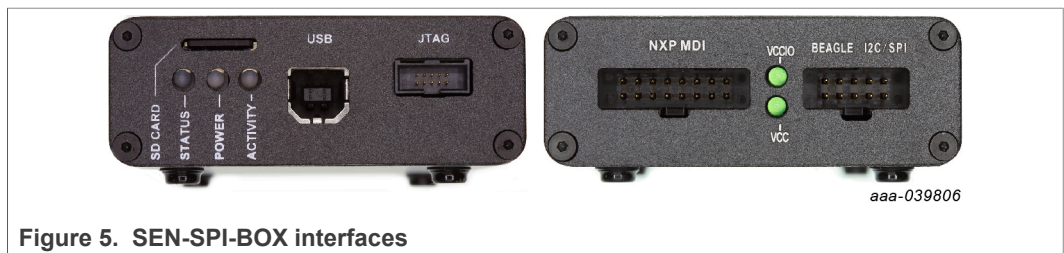

Figure 5. SEN-SPI-BOX interfaces

3.2 Pinout

The NXP MDI (16-pin) and Beagle (10-pin) connectors can be used with their own dedicated ribbon cable or with breadboard jumper wires.

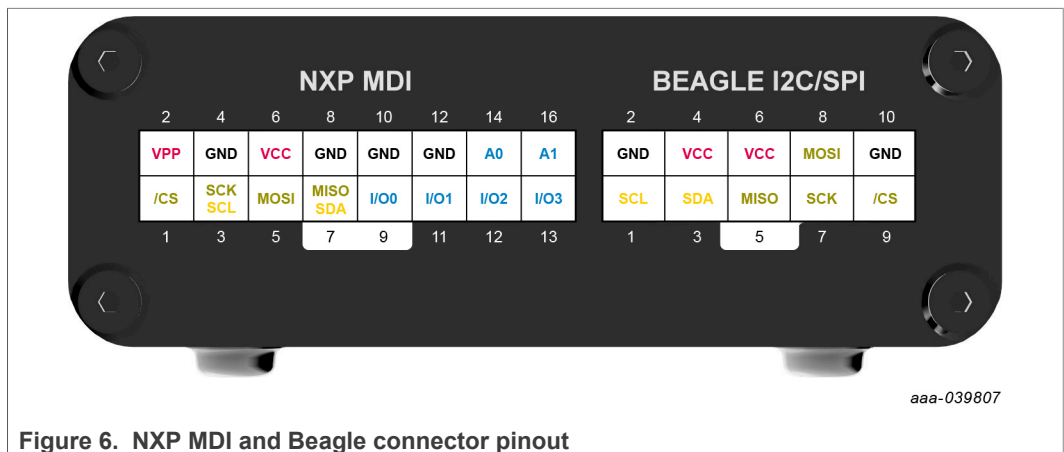

Figure 6. NXP MDI and Beagle connector pinout

3.2.1 NXP MDI connector

Table 1. NXP MDI connector pinout

Pin	Label	Description
6	VCC	Power supply: off, 3.3 V or 5 V
2	VPP	High-voltage supply: off, 10.5 V or 13.5 V
4,8,10,12	GND	Ground
1	/CS	SPI chip select
3	SCK/SCL	SPI serial clock / I ² C serial clock
5	MOSI	SPI output
7	MISO/SDA	SPI input / I ² C serial data
9, 11, 13, 15	I/Ox	Configurable input/output
14, 16	Ax	Analog input

3.2.2 Beagle connector

Table 2. Beagle connector pinout

Pin	Label	Description
4, 6	VCC	Power supply: off, 3.3 V or 5 V
2, 10	GND	Ground
9	/CS	SPI chip select
7	SCK	SPI serial clock
8	MOSI	SPI output
5	MISO	SPI input
1	SCL	I ² C serial clock
3	SDA	I ² C serial data

3.2.3 Beagle debug cable

To directly connect any sensor, use the debug cable (to be plugged into the Beagle connector).

Figure 7 identifies the debug cable pinout connections.

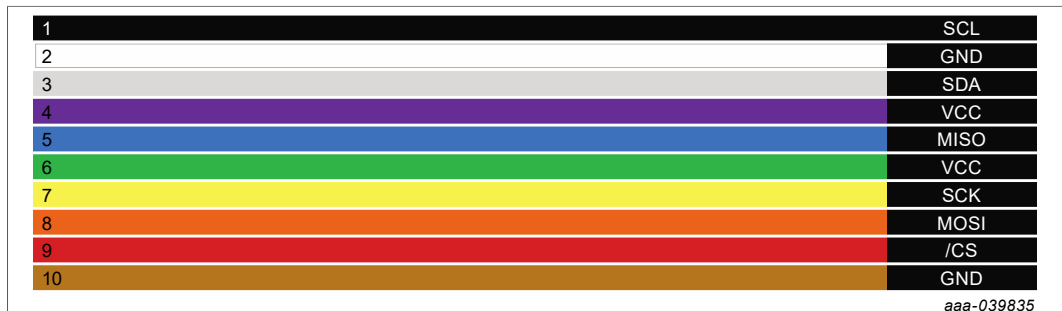

Figure 7. Debug cable pinouts

3.3 LED indicators

3.3.1 Rear view

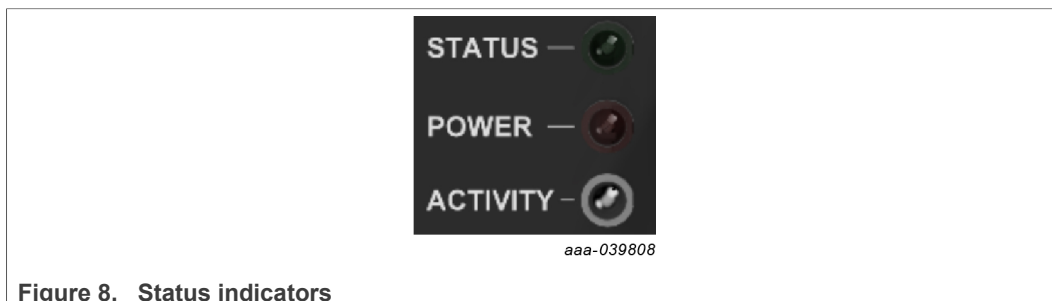

Figure 8. Status indicators

- Status: Blinks green if running, if red, something is wrong
- Power: Red when board is powered
- Activity: Fast blink when communicating with the software (red for input, green for output, orange when directional)

3.3.2 Front view



Figure 9. Front LED indicators

- VCCIO: Green if VCCIO is turned on
- VCC: Green if VCC is turned on

3.4 Block diagram

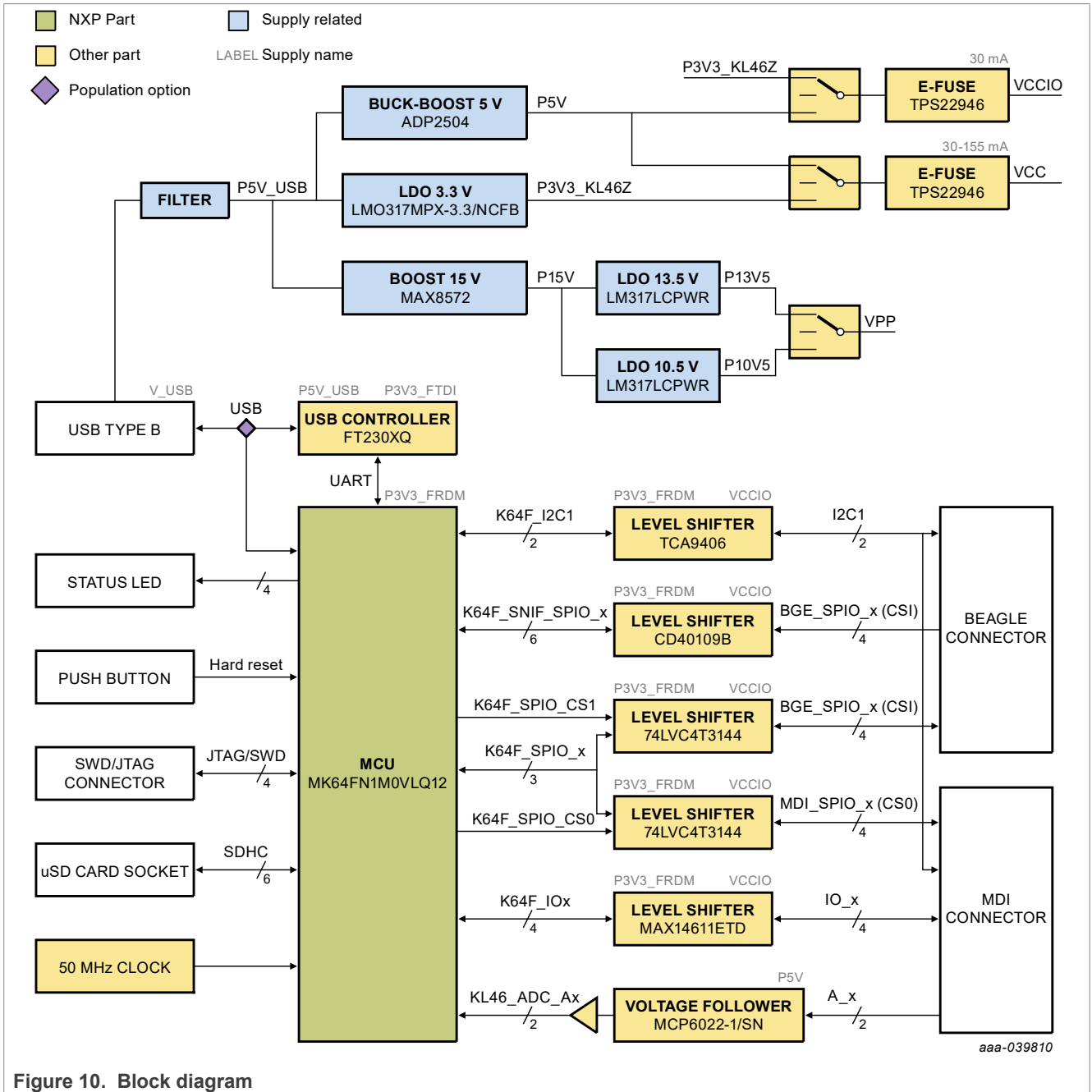

Figure 10. Block diagram

4 Setting up the FFV Tool kit

4.1 Software installation

4.1.1 Download software

Go to <http://www.nxp.com/SEN-SPI-BOX> to download the software.

4.1.2 System requirements

The computer system hosting the Sensor FFV Tool software and SEN-SPI-BOX hardware must meet the following requirements:

- Windows 10 (x86, x64). Although Windows Vista, 7 are anticipated to work as well, these systems have not been tested and are not supported.
- For each SEN-SPI-BOX, a USB (V3.0) port must be available on the host PC. NXP anticipates the SEN-SPI-BOX will work with USB V1.1 or V2.0 ports. However, NXP has not tested the SEN-SPI-BOX with USB V1.1 or V2.0 ports.
- The screen size shall be at least 1024 x 768 pixels. NXP does not recommend using screens with resolution smaller than 1024 x 768 pixels. Although the software runs on screens with lower resolution, the GUI and forms are less convenient to use.
- Software to display Adobe PDF documents is required to read the documentation and the data sheets.

4.1.3 Setup

Double-click the downloaded .msi file and follow the instructions.

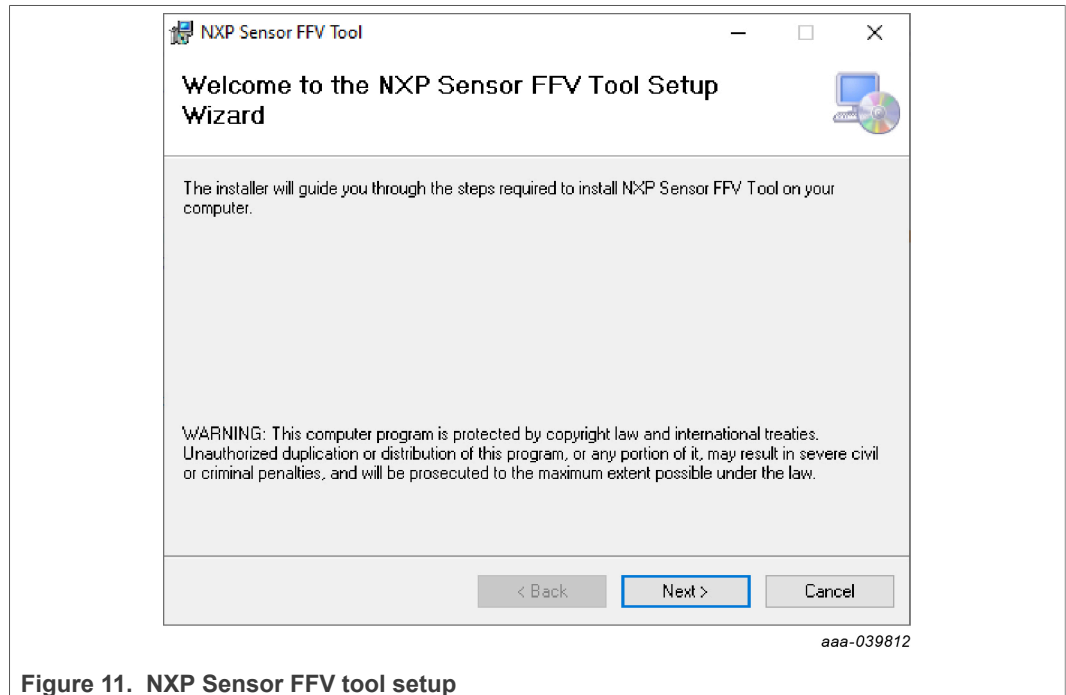

Figure 11. NXP Sensor FFV tool setup

NXP recommends using the default installation folder, however the installation location can be customized.

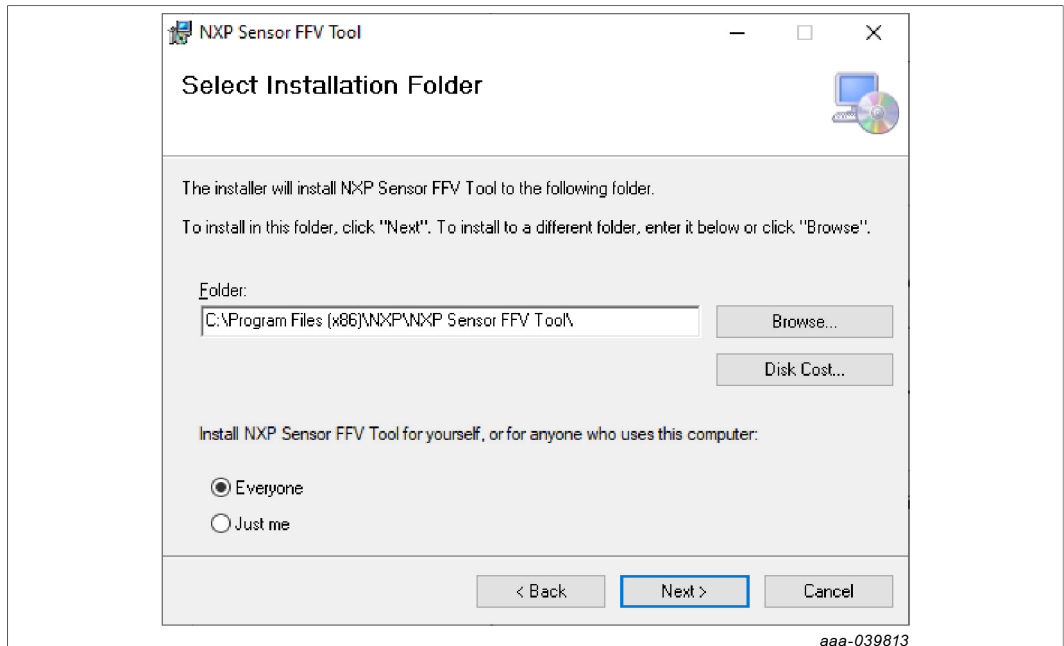

Figure 12. NXP Sensor FFV installation folder

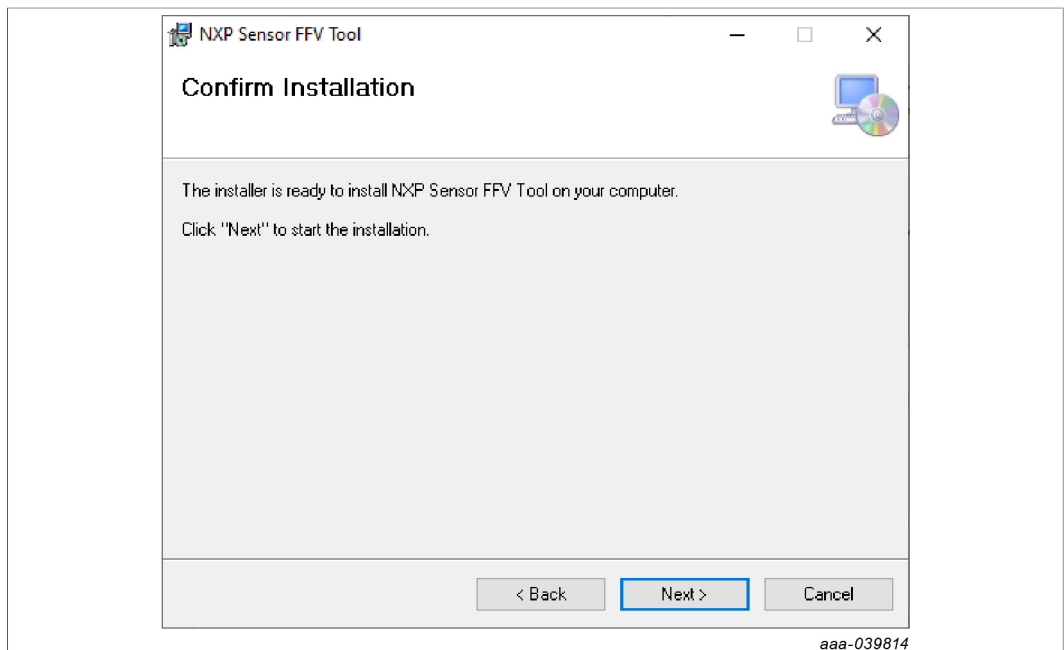

Figure 13. NXP Sensor FFV tool installation confirmation

4.2 Prepare the kit

4.2.1 Connect the kit

Connect the FFV kit via the USB Type-B cable included in the kit.



Figure 14. Connecting the kit via USB Type-B cable

A new USB design should appear in the Windows device manager as shown in [Figure 15](#). There is no need to install a specific driver because the FFV kit uses standard Windows COM port drivers (usbser.sys, hhdsrerial64.sys) already present in Windows-based computers.

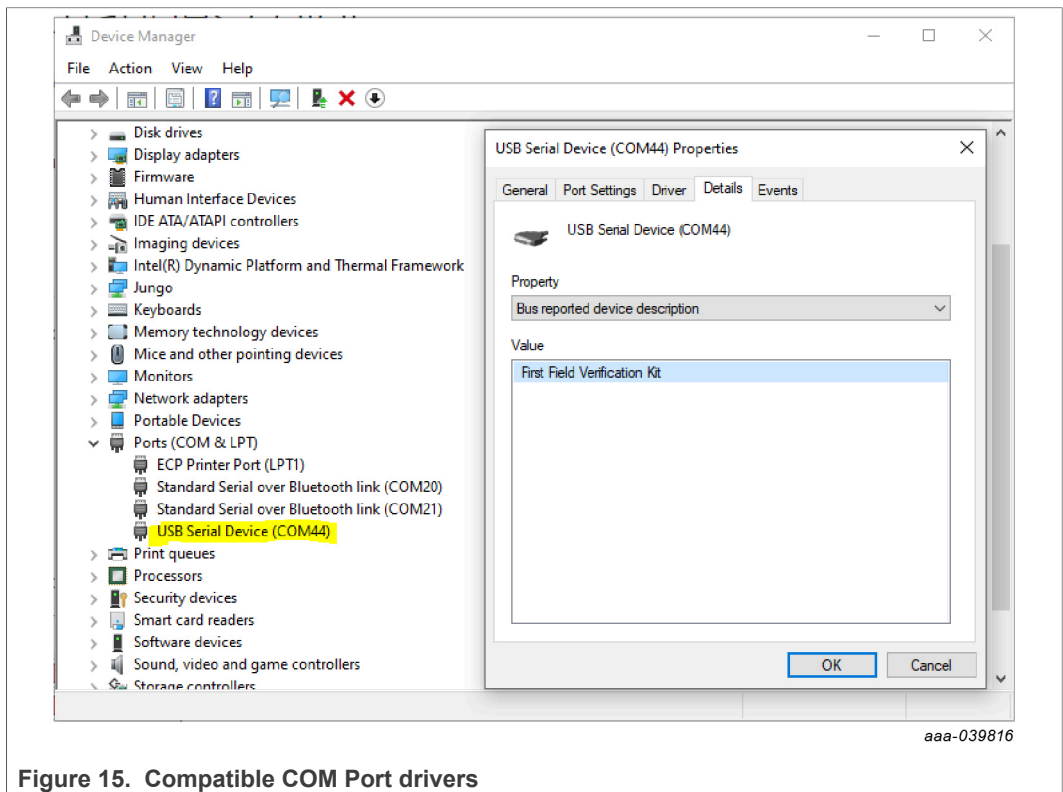

Figure 15. Compatible COM Port drivers

4.2.2 Launch the software

4.2.2.1 Start

Start the GUI through the launcher or double-click a .ffvpkg file (if .ffvpkg is used, skip [Section 4.2.2.2](#) and jump directly to step [Section 4.2.2.3](#))

4.2.2.2 Select a project

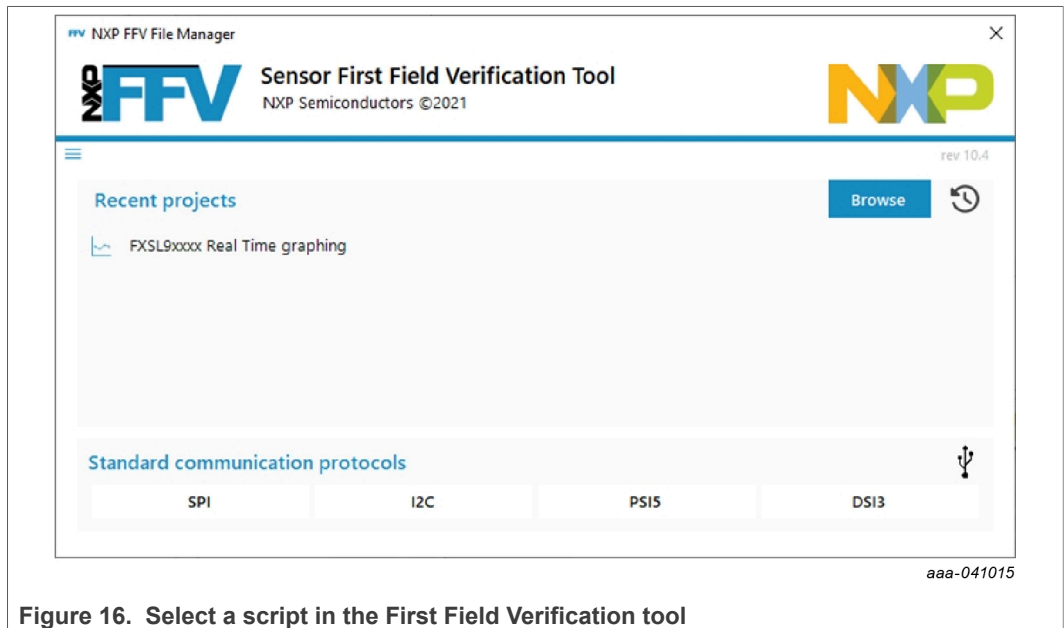

Figure 16. Select a script in the First Field Verification tool

There are several ways to open projects.

Previously Opened Project: Previously opened projects are listed in “Recent projects”. Double-click the “recent project” to reopen the project. To learn more, refer to [Section 6](#).



Figure 17. Open an existing project

NXP Compatible sensor without dedicated package file: The user has an NXP compatible sensor but does not have a dedicated package file. Click the menu bar and review the existing “Predefined sensor packages”. To learn more, refer to [Section 6](#).

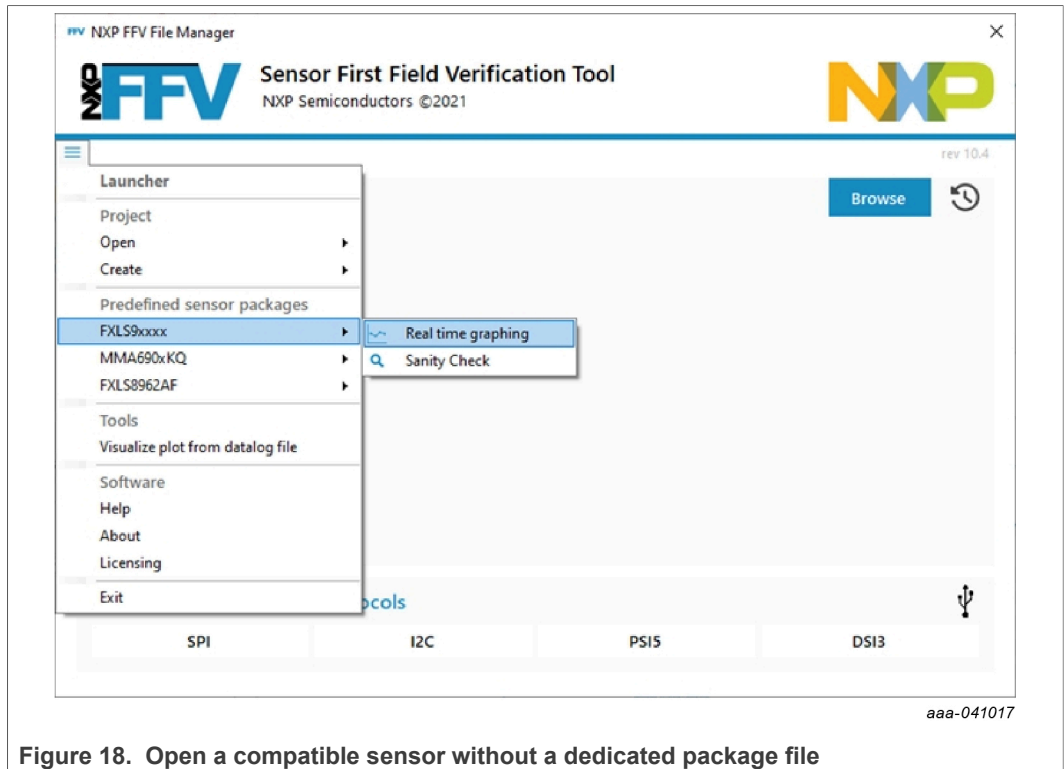

Figure 18. Open a compatible sensor without a dedicated package file

NXP .ffvpkg file: The user has an NXP-provided .ffvpkg file. Click the “Browse” button, select the file and open it. Alternately, drag and drop the file in “Recent projects” adding the file to the “recent projects” list. To learn more, refer to [Section 6](#).

Unsupported device or missing package to communicate with the device: The user has an unsupported device or lacks the necessary package to communicate with the sensor. In this case, use the “Standard communication protocols”. These protocols provide basic functions to communicate with SPI, I²C, PSI5, or DSI3 sensors. To learn more, refer to [Section 5](#).

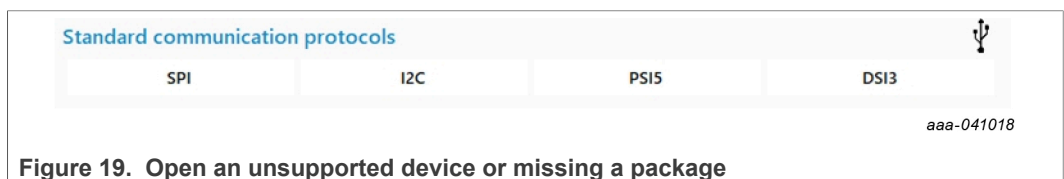

Figure 19. Open an unsupported device or missing a package

Note: *PSI5 and DSI3 protocols necessitate special hardware which is sold separately from the SEN-SPI-BOX kit. (SEN-PSI5-ADAPTER and SEN-DSI3-ADAPTER).*

4.2.2.3 FFV kit search

The software scans all the compatible devices. If this operation fails, ensure that everything is properly connected and retry.

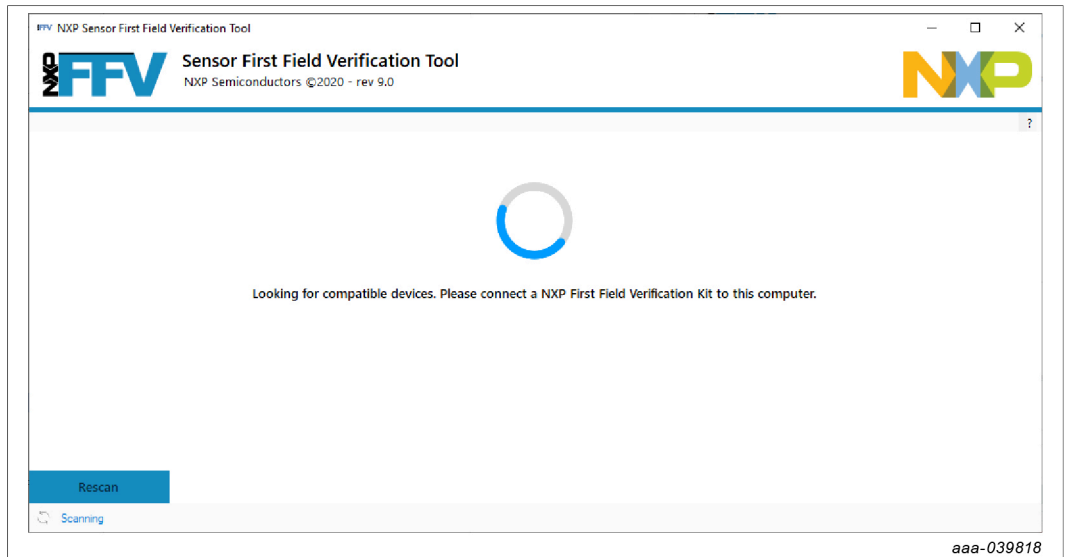

Figure 20. FFV compatible device scan

4.2.2.4 Enable the power supplies

After the software detects the kit, enable and select the voltage for the power supplies as needed.

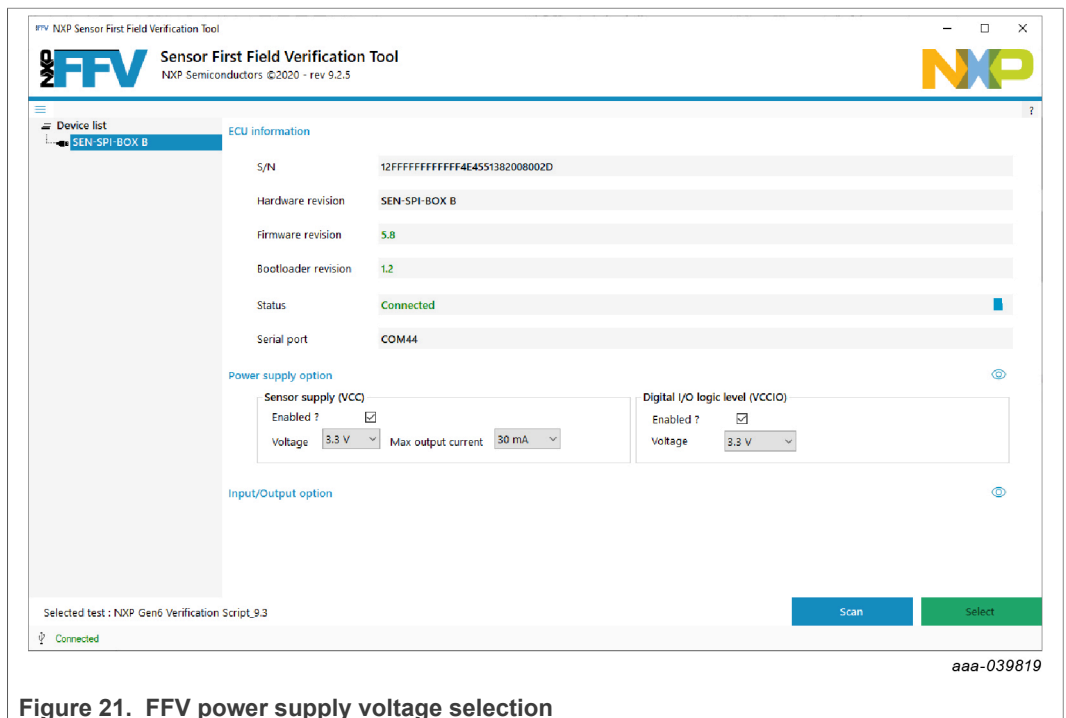

Figure 21. FFV power supply voltage selection

4.2.2.4.1 VCC

When using the FFV kit standalone (no MCU attached to the sensor nor external supply), enable the VCC supply.

If the sensor is already powered by an external source, disabled the option.

4.2.2.4.2 VCCIO

VCCIO is the logic voltage of the SPI and I²C interfaces. It must be set to a value compatible with the sensor VCC supply.

4.2.2.4.3 VPP

VPP is the high-voltage supply which could be used in specific cases. It must be carefully used and may damage the sensor if not used correctly.

5 Using standard communication protocols

The SEN-SPI-BOX supports natively SPI and I²C protocols.

To add PSI5 and/or DSI3 automotive protocol interfaces to the SEN-SPI-BOX, adapter boards may be purchased separately.

5.1 Native protocols

When SPI or I²C protocol is selected from the “Standard communication protocol” block, it opens as shown in [Figure 22](#).

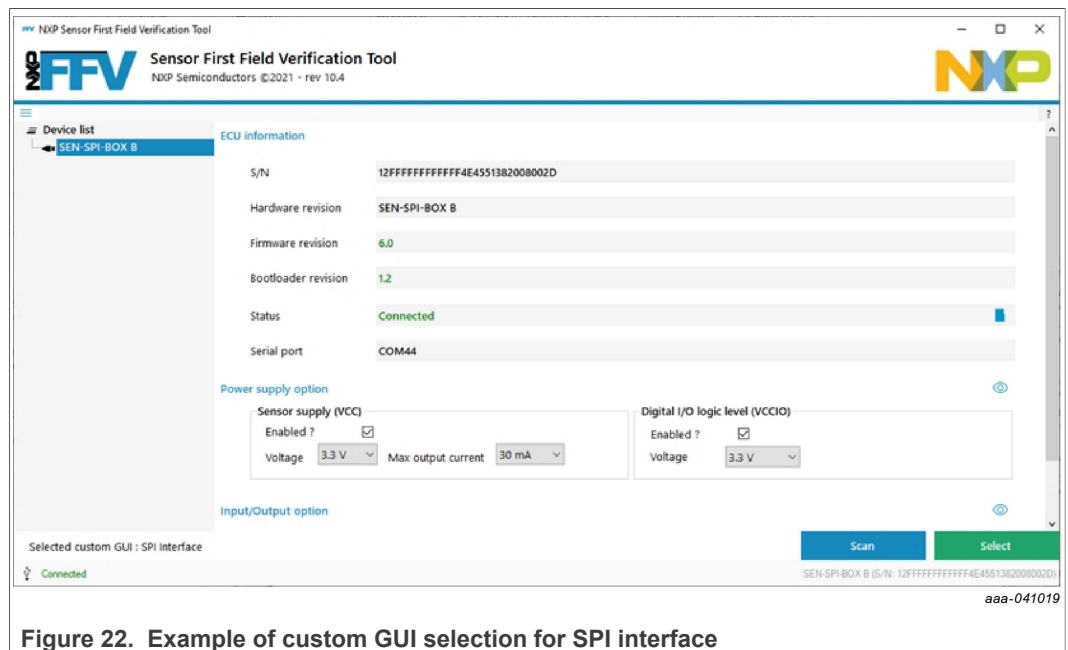

Figure 22. Example of custom GUI selection for SPI interface

Choose the power supplies as explained [Section 4.2.2.4](#). Select the SEN-SPI-BOX kit (green button bottom right).

Use the debug cable provided in the kit to connect the sensor with the SEN-SPI-BOX board.

Click on the "Select" button once everything is configured. The software opens the form corresponding to the selected protocol (SPI or I²C) as detailed in [Section 5.1.1](#) and [Section 5.1.2](#).

5.1.1 SPI

The SPI menu offers the necessary functions to transfer data. It supports frequencies up to 10 MHz and the four different SPI modes. Transfer width supports 8 to 32 bits data transfers. There are two selections for Chip Select that correspond to the NXP MDI and Beagle terminals.

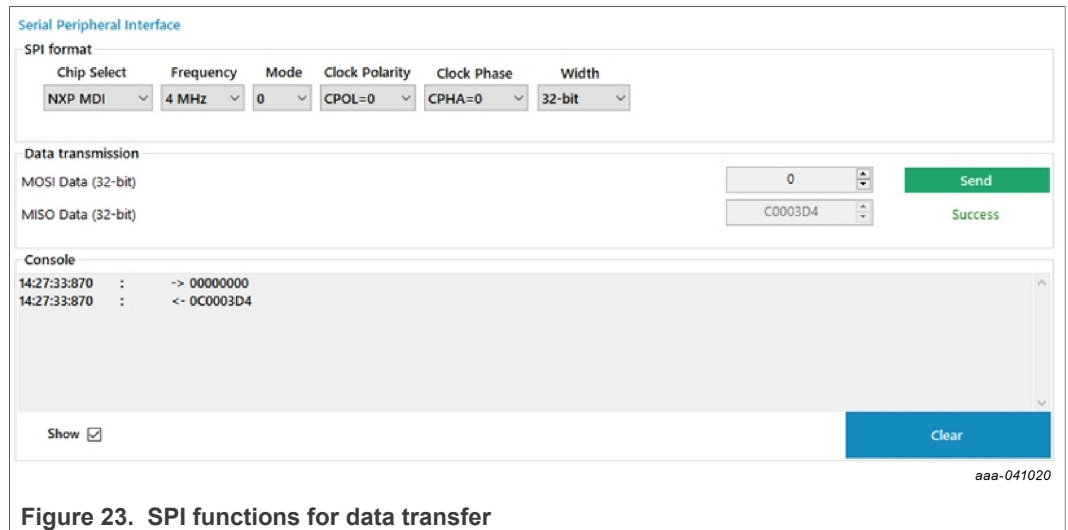

Figure 23. SPI functions for data transfer

Once the configuration set, data can be easily transferred using the “Send” button.

5.1.2 I²C

This I²C interface supports up to 64 byte data transfers.

Configure the 7-bit sensor address and the frequency of the bus (up to 1 MHz).

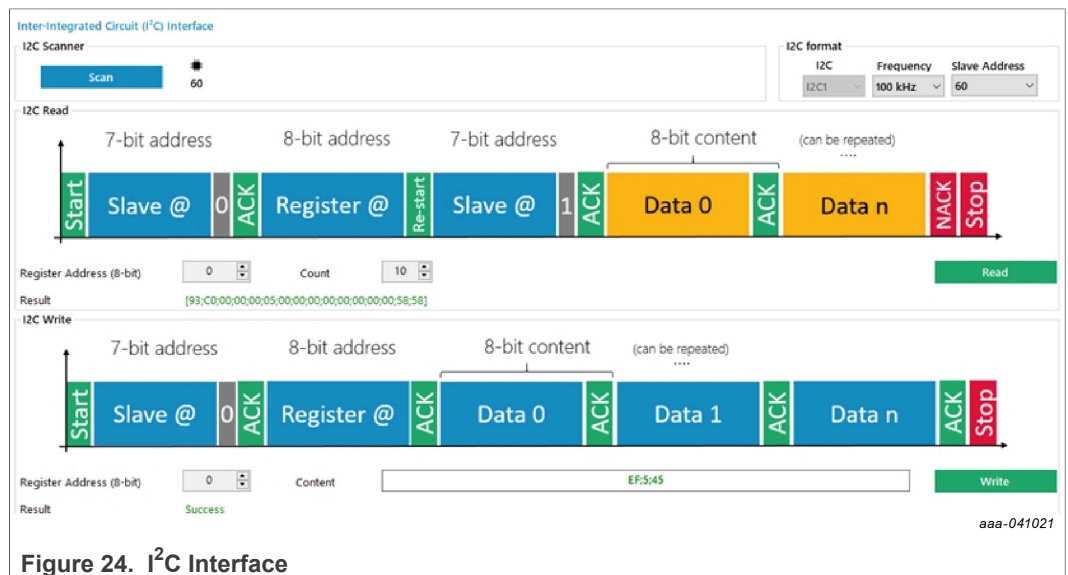

Figure 24. I²C Interface

5.1.2.1 I²C scanner

The SEN-SPI-BOX is able to scan for I²C sensor addresses. To see all compatible connected sensors, click the “Scan” button.

5.1.2.2 Read

Select a register start address and the number of data to read. The result is shown as an array of 8-bit data.

5.1.2.3 Write

Select a start register and write the value in hexadecimal. Separate multiple values using a semicolon (;).

5.2 Optional protocols

The selection of DSI3 or PSi5 protocol in the “Standard communication protocol” block necessitates a special adapter board (SEN-PSi5-ADAPTER or SEN-DSI3-ADAPTER) for each protocol.

1. Check and set the compatible power supply. Always refer to and set the power settings using the value printed on the bottom of the board. Table 3 provides a summary for convenience.

Table 3. DSI3/PSi5 adapter power settings summary

	SEN-DSI3-ADAPTER	SEN-PSi5-ADAPTER
VCC, VCCIO	5 V	3.3 V
VPP	13.5 V	10.5 V

2. Connect the adapter board on the SEN-SPI-BOX using the NXP MDI terminal. Components are on the top. Check the connector coding to avoid mistakes.
3. Click the Scan button.
4. Select the PSi5/DSI3 transceiver listed.

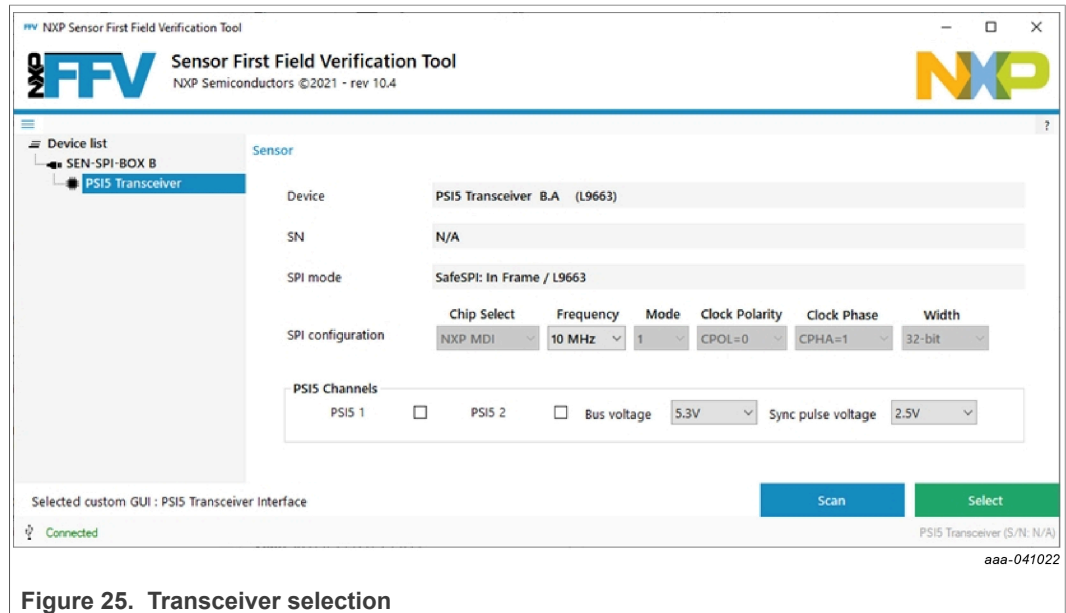

Figure 25. Transceiver selection

5.2.1 DSI3

Two DSI3 interfaces are available on the SEN-DSI3-ADAPTER board: DSI3 channel 0 and DSI3 channel 1.

To enable or disable the interface for each channel, use the “DSI3 channel enable” checkbox.

Enabling a channel automatically sends discovery pulses. Every compatible device present on the bus is assigned a unique physical address.

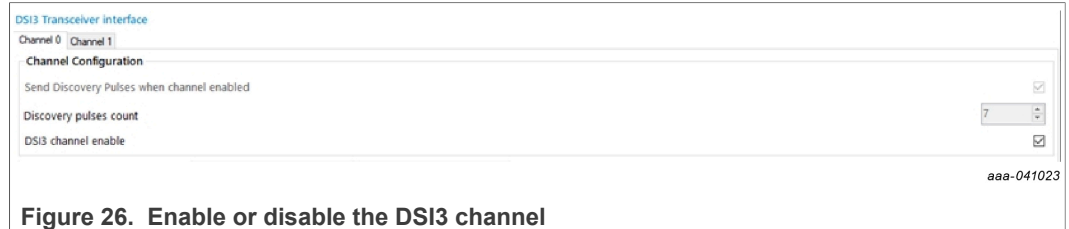

Figure 26. Enable or disable the DSI3 channel

To exit PDCM mode, the corresponding DSI3 channel must be disabled.

5.2.1.1 Command and response mode (CRM)

By default the transceiver boots in CRM mode. If a sensor is connected to the bus and owns a physical address, users may be able to send a CRM command.

The sensor manufacturer specifies the commands and the data to send.

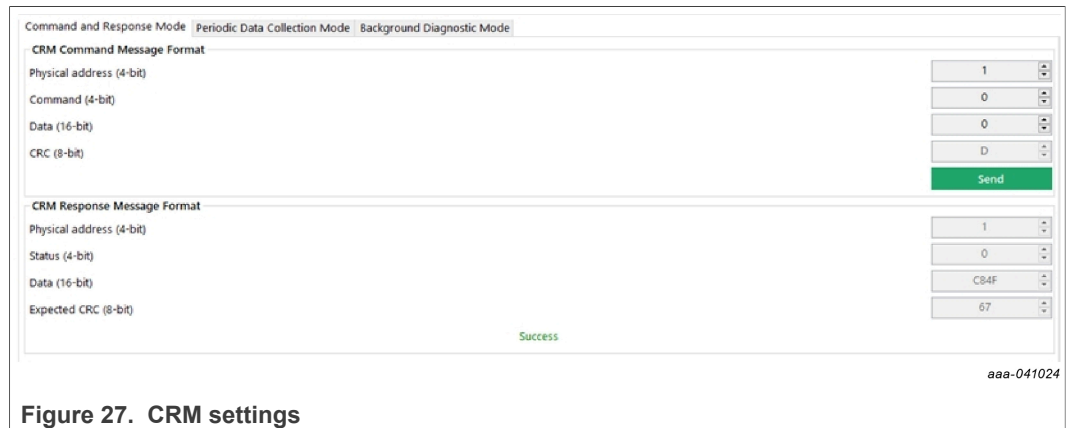

Figure 27. CRM settings

5.2.1.2 Periodic data collection mode (PDCM)

Once the sensor is configured using CRM commands, the user must set the DSI3 receiver correctly for PDCM operations.

1. Selected chip time (transceiver chip time must be identical to the chip time of the DSI3 sensor).
2. Associate source ID to timeslot. If a mismatch occurs between the frame source ID and the slot number, the mismatch raises an error.
3. Choose whether Broad Read Command (BRC) is sent every 500 µs or manually (when the user clicks the "Update" button).

The user can then switch the DSI3 transceiver to PDCM mode by clicking the “Enter” button. The transceiver stays in PCDM mode while the bus is powered.

To return to CRM mode, the user must power off, then power on, the associated channel to return to CRM mode.

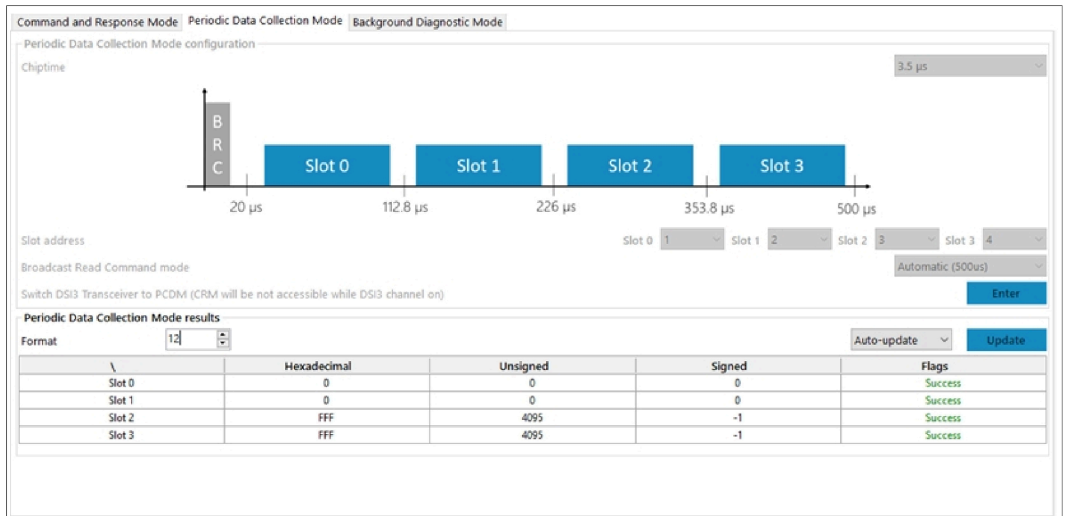

Figure 28. PDCM settings

5.2.1.3 Background diagnostic mode (BDM)

Background diagnostic mode is not supported.

5.2.2 PSI5

Two PSI5 interfaces are available on the SEN-PSI5-ADAPTER board: PSI5 channel 0 and PSI5 channel 1.

The interfaces are enabled/disabled using the “PSI5 channel enable” checkbox.

The interface only works for “Sensor to ECU” communication (ECU to Sensor communication is not supported yet).

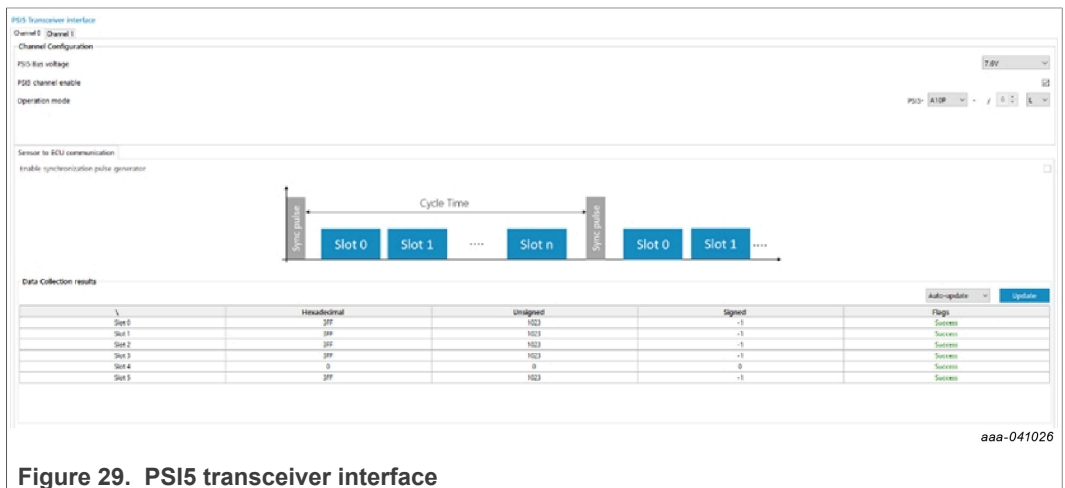

Figure 29. PSI5 transceiver interface

The operation mode must be selected according to the PSI5 sensor capability.

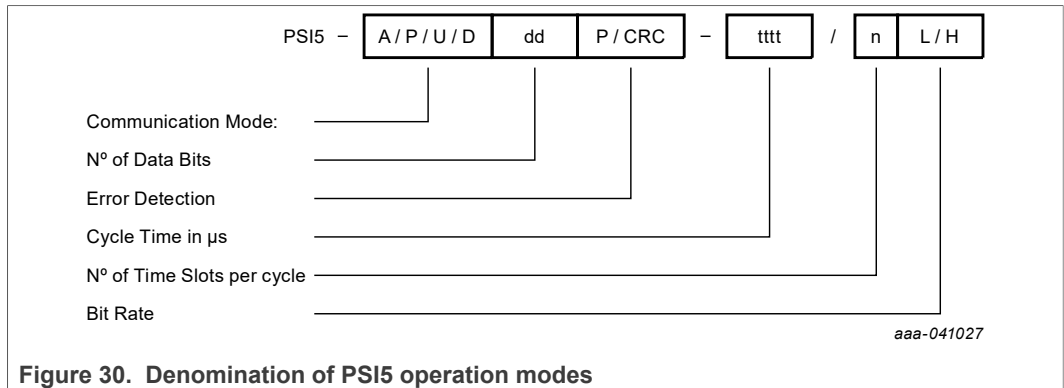

Figure 30. Denomination of PSI5 operation modes

PSI5 supports both synchronous (P) and asynchronous (A) modes. [Figure 30](#) provides a visual summary of the PSI5 operation modes and [Table 4](#) provides details for each field.

Table 4. PSI5 operation mode details

Field	Possible values
Communication mode	Synchronous: P Asynchronous: A
Number of data bits	16-bit: 16 10-bit: 10
Error detection	CRC: C Parity: P
Cycling time	200 μs to 8360 μs (32 μs step)
Number of slots per cycle	1 to 6
Bit rate	125 kbit/s: L 189 kbit/s: H

6 Using .ffvpkg or predefined sensor packages

6.1 Connect the sensor to the FFV kit

Plug the sensor to the Sensor FFV kit. If provided by NXP, use the NXP socket board, or connect your own board. The pinout is described in [Section 3.2](#).

6.2 Scan for sensor

In the software, press the “Scan” button.

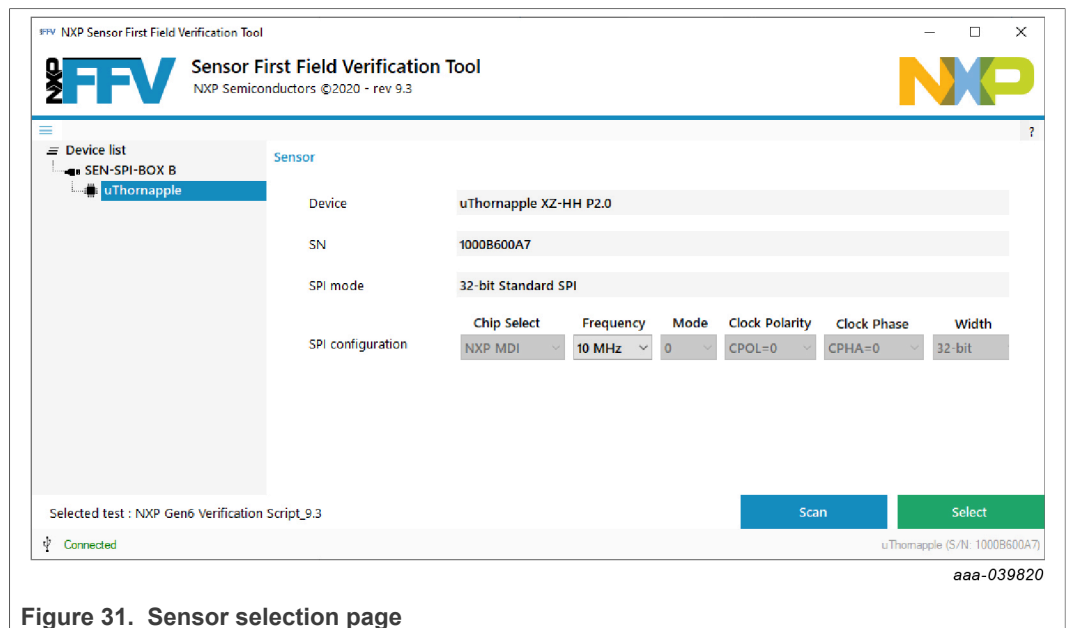

Figure 31. Sensor selection page

A list of the compatible sensors appears.

6.3 Configure the sensor

Select the sensor from the list and if available, configure the SPI/I²C settings.

Note: The new configuration is applied only when the "Select" button is activated.

6.3.1 Advanced window for advanced features

To open the advanced windows, right-click any compatible sensor.

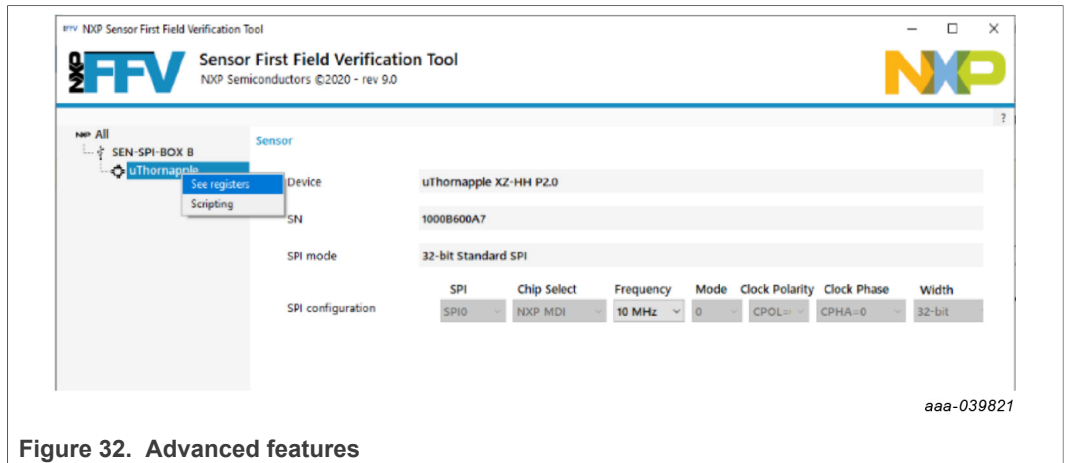

Figure 32. Advanced features

Note: This feature should be used with special care and is not synchronized with standard functions.

This capability means that users can overwrite the sensor register without seeing it in the other window if it is not updated.

Currently, there are two advanced forms:

- Register table: Quick and easy way to read and modify the sensor memory.
- Scripting: To configure the sensor, automate actions with a command list.

6.3.1.1 Register table

Figure 33 presents the values found in the registers of the sensor.

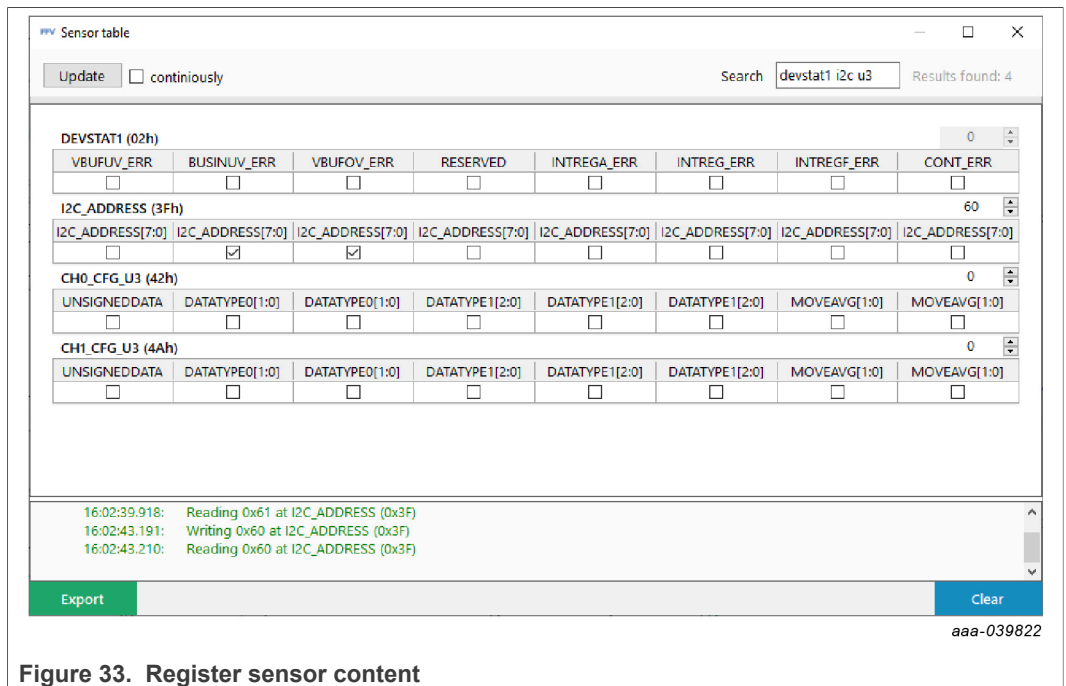

Figure 33. Register sensor content

The data presented in the sensor table, shown in Figure 33, is not real time and a mismatch could exist between the value in the table and the actual register value. The value is displayed in hexadecimal format.

Use filters to reduce the number of visible registers (address, register name, bit field name).

6.3.1.2 Custom script

In parallel, custom scripts can be executed if users want to automate some actions.

To learn how to write scripts, review [Section 6.5.3.1](#).

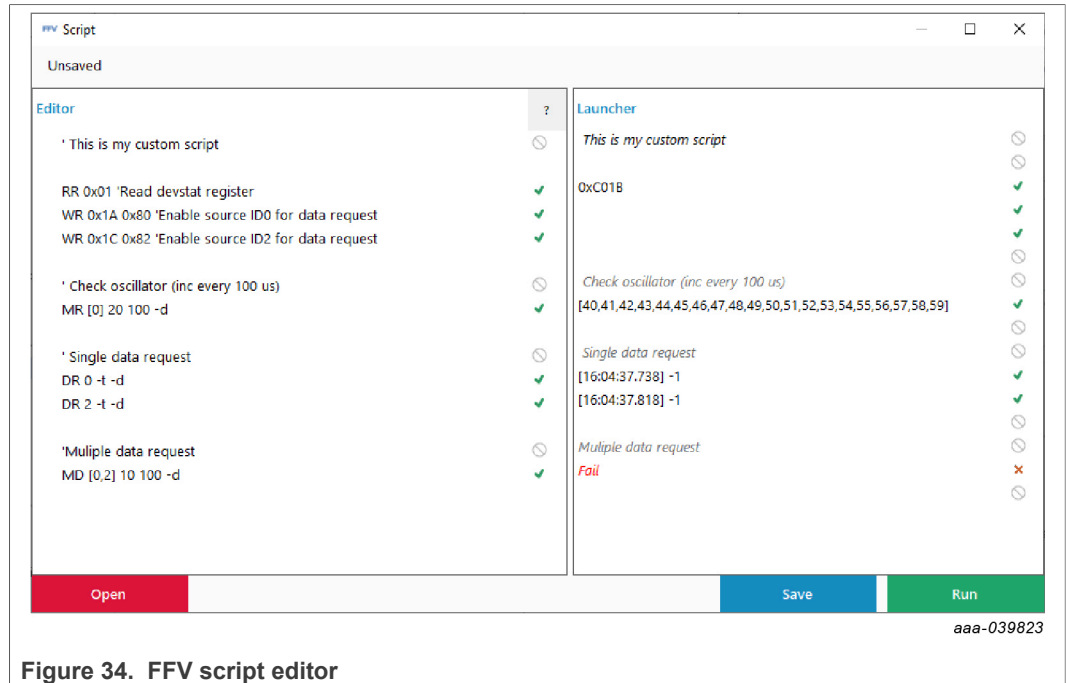

Figure 34. FFV script editor

6.4 Open the package

Press the "select" button to open the package content.

There are two types of .ffvpkg files:

- [Test File](#) (See the magnifier icon in [Figure 35](#).)
- [Datalogger File](#) (See the graphing icon in [Figure 35](#).)

Depending on the file, the correct form automatically opens.

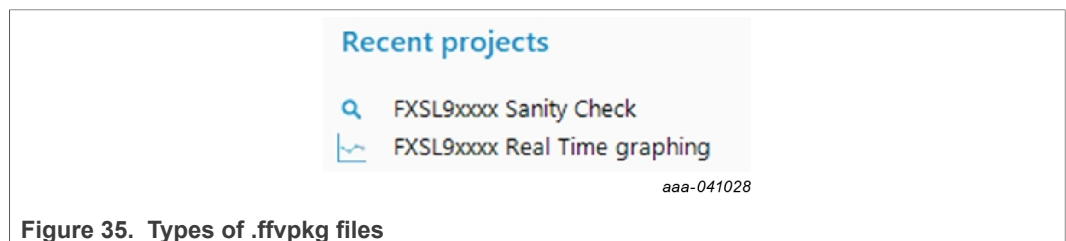

Figure 35. Types of .ffvpkg files

If using .ffvscript file, jump to [Section 6.5.3](#).

6.5 Use the package files

6.5.1 Test file

6.5.1.1 Configure the test

If available, press the wrench icon to change the test settings. Users can skip some tests by unchecking the test in the list.

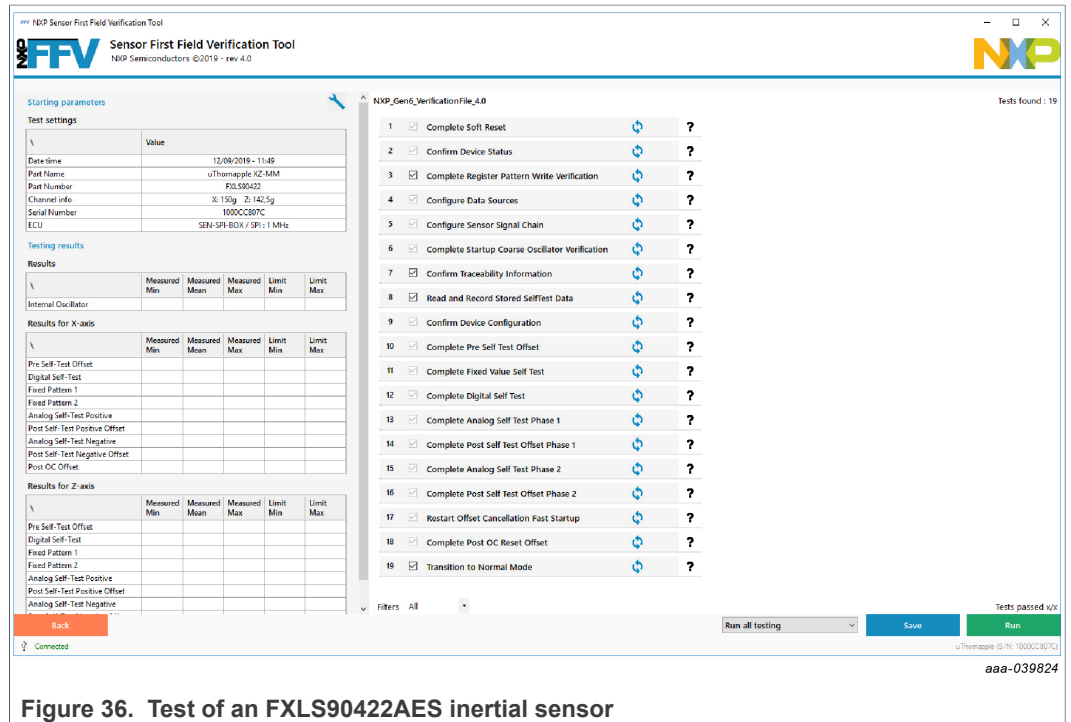

Figure 36. Test of an FXLS90422AES inertial sensor

6.5.1.2 Run the test

Once everything is configured, press the “Run” button. Wait while the sequence is being executed. To view the details of the selected test, click the folder icon.

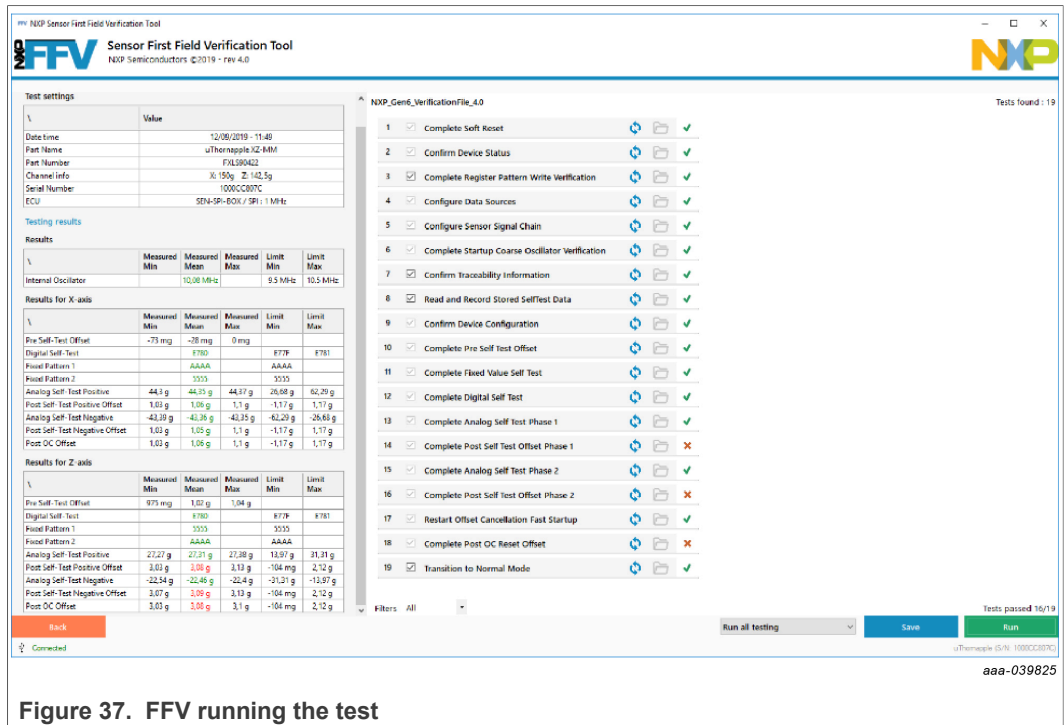

Figure 37. FFV running the test

When complete, export the test results by clicking “Save”. A “.ffvreport” file and a .pdf is generated. The results are visible later when opening the file.

Close the software.

6.5.1.3 Open a test report

Open a test report file by double-clicking a “.ffvreport” file or by launching the software and selecting the file from the window browser.

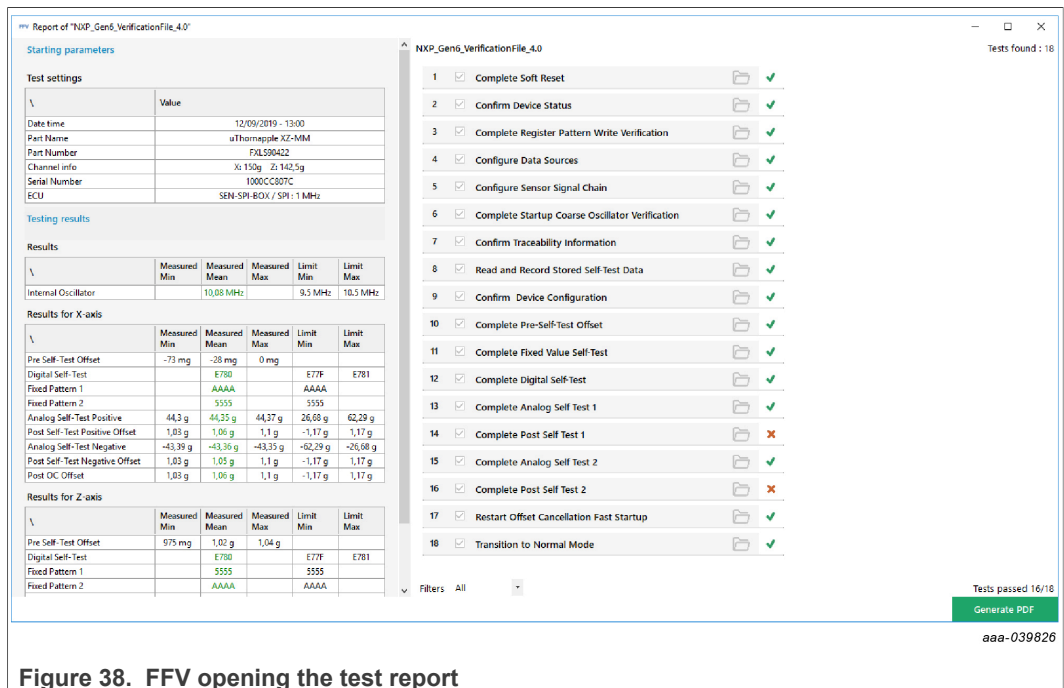

Figure 38. FFV opening the test report

This form is read-only. Re-executing any test from here is not possible.

6.5.1.4 Create a custom test file using C# .Net

Custom test files can be developed using Visual Studio IDE with C# .Net framework. Special documentation is available from the FFV software by clicking “Create advanced C# script” from the launcher.

6.5.2 Datalogger file

6.5.2.1 Configure the sensor

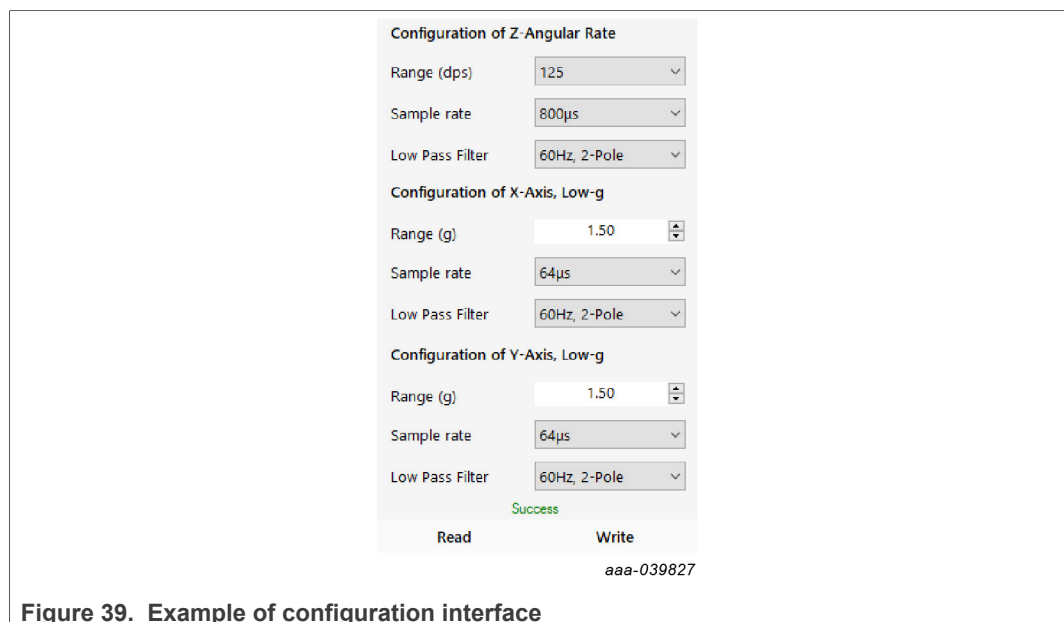

Figure 39. Example of configuration interface

The left panel offers many high-level settings the user may access to configure the sensor. Do not forget to apply the settings before starting any data stream.

This panel may display differently depending on the selected file/sensor.

6.5.2.2 Configure the streaming settings

The streaming panel is split in 3 different sub panels.

6.5.2.2.1 Stream settings

The Stream settings panel allows users to select:

- “Sampling time” between two data (make sure that the communication frequency is high enough to support the highest rate).
- “Count”: The number of samples to be collected (any non-number value is turned into infinite).
- “Acquisition time”: Not selectable. It just gives the result of “Count” x “Sampling Time”.
- “Unit in LSB”: Unchecked. Shows the plot with the standard units, else shows in LSB.
- “Start” / “Stop”: Launch/stop the stream.

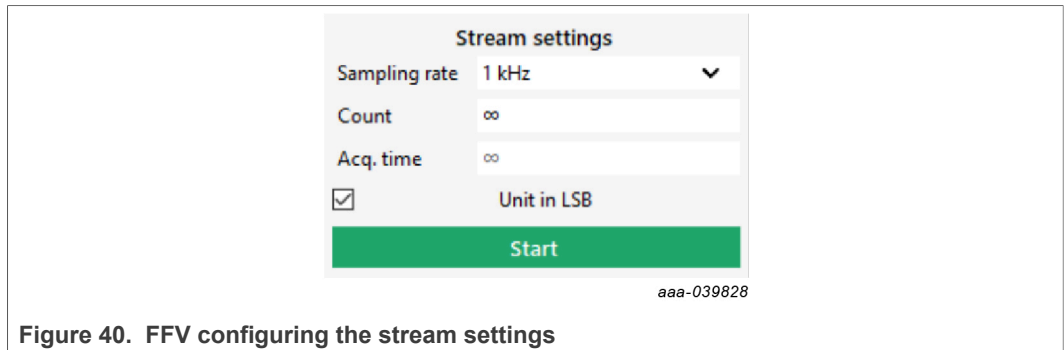

Figure 40. FFV configuring the stream settings

6.5.2.2.2 Stream info

The stream info panel displays status information about the data collection.

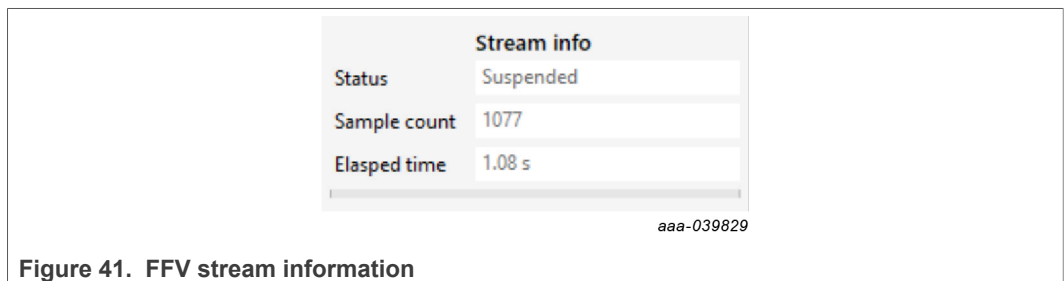

Figure 41. FFV stream information

6.5.2.2.3 Recording settings

The Recording settings panel allows the user to record the incoming data stream.

- **Output file:** The path of the record
- **Status:** Indicates whether a recording is taking place.
- **Recording time:** Displays how long the recording has been running.
- **Record / Stop:** Launches/Stops the record.

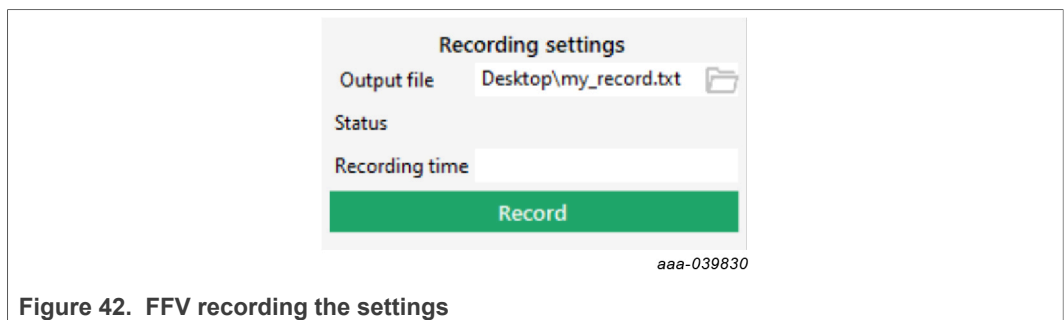

Figure 42. FFV recording the settings

6.5.2.2.4 Run the datalog

Once everything is configured, take advantage on the fast real-time data plotting.

6.5.3.1.1 Generic sensor commands (high-level)

- RR <address> [options]: Read register command.
- WR <address> <data> [options]: Write register command.
- DR <source ID> [options]: Sensor Data Request command (Auto-Safety sensor).

6.5.3.1.2 Generic advanced sensor commands (high-level)

- MR <address(es)> <multiplier> <delay> [options]: Multi read register command, real time.
 - address(es): Can be [@1, @2, @3] or range as [@1 - @3] (up to 1024 bytes).
 - multiplier: Repeat the address sequence.
 - delay: Time in μ s between each command. (up to 100 ms, check the bus speed compatibility).
- MD <source Id> <multiplier> <delay> [options]: Multi data-request register command, real time).
 - source Id: Can be [1, 2, 3] or range as [1 - 3].
 - multiplier: Repeat the source Id sequence.
 - delay: Time in μ s between each command. (up to 100 ms, check the bus speed compatibility).

6.5.3.1.3 Generic SPI commands (low level)

- S32 <data> [options]: 32-bit SPI transfer.
- S24 <data> [options]: 24-bit SPI transfer.
- S16 <data> [options]: 16-bit SPI transfer.
- S8 <data> [options]: 8-bit SPI transfer.

6.5.3.1.4 Generic I²C commands (low level)

Not supported yet.

6.5.3.1.5 Other commands (low level)

- SETV <channel> <voltage> [options]: Power supply command (*Special care is required when using this command. Applying an incorrect voltage may damage a sensor.*).
 - channel: VCC, VCCIO, or VPP.
 - voltage: (VCC, VCCIO) OFF, 3.3, 5 - (VPP) OFF, 10.5, 13.5.
- DELAY <time> [options]: Software delay command in milliseconds, not real time, only accurate for long timing.
- ': Comment.

6.5.3.1.6 Using [Options]

At the end of the command line, add a "-" followed by the option flag. The available flags are:

- -D: Output result in decimal rather than hex.
- -T: Print timestamp.

6.5.3.1.7 Examples

Table 5. Example script commands

Command	Command comment
rr 0x3e	'read address 3E in hexadecimal, result output is in hexadecimal.
rr 25 -t	'read register 25 (19 in hex), result output in hexadecimal, timestamp is displayed.
rr 0x12 -d	'read address 12 in hexadecimal, result output is in decimal.
wr 0x1A 0xAA	'write 0xAA in the register 0x1A.
wr 0x41 255	'write 0xFF in the register 0x41.
dr 0 -d -t	'data request channel 0 with timestamp and decimal output.
mr [0-5] 1 0	'read addresses from 0 to 5 once at the highest bus speed.
mr [0,1,2,3,4,5] 1 0	'same as above.
mr 0 20 100 -d	'read register at address 0 20 times every 100 μ s with a decimal display.
md 0 5 100	'data request for channel 0, 5 times every 100 μ s.
md [0,1] 10 200 -d	'data request channel 0 and 1, 20 times every 200 ms, decimal display.

7 Legal information

7.1 Definitions

Draft — A draft status on a document indicates that the content is still under internal review and subject to formal approval, which may result in modifications or additions. NXP Semiconductors does not give any representations or warranties as to the accuracy or completeness of information included in a draft version of a document and shall have no liability for the consequences of use of such information.

7.2 Disclaimers

Limited warranty and liability — Information in this document is believed to be accurate and reliable. However, NXP Semiconductors does not give any representations or warranties, expressed or implied, as to the accuracy or completeness of such information and shall have no liability for the consequences of use of such information. NXP Semiconductors takes no responsibility for the content in this document if provided by an information source outside of NXP Semiconductors. In no event shall NXP Semiconductors be liable for any indirect, incidental, punitive, special or consequential damages (including - without limitation - lost profits, lost savings, business interruption, costs related to the removal or replacement of any products or rework charges) whether or not such damages are based on tort (including negligence), warranty, breach of contract or any other legal theory. Notwithstanding any damages that customer might incur for any reason whatsoever, NXP Semiconductors' aggregate and cumulative liability towards customer for the products described herein shall be limited in accordance with the Terms and conditions of commercial sale of NXP Semiconductors.

Right to make changes — NXP Semiconductors reserves the right to make changes to information published in this document, including without limitation specifications and product descriptions, at any time and without notice. This document supersedes and replaces all information supplied prior to the publication hereof.

Suitability for use — NXP Semiconductors products are not designed, authorized or warranted to be suitable for use in life support, life-critical or safety-critical systems or equipment, nor in applications where failure or malfunction of an NXP Semiconductors product can reasonably be expected to result in personal injury, death or severe property or environmental damage. NXP Semiconductors and its suppliers accept no liability for inclusion and/or use of NXP Semiconductors products in such equipment or applications and therefore such inclusion and/or use is at the customer's own risk.

Applications — Applications that are described herein for any of these products are for illustrative purposes only. NXP Semiconductors makes no representation or warranty that such applications will be suitable for the specified use without further testing or modification. Customers are responsible for the design and operation of their applications and products using NXP Semiconductors products, and NXP Semiconductors accepts no liability for any assistance with applications or customer product design. It is customer's sole responsibility to determine whether the NXP Semiconductors product is suitable and fit for the customer's applications and products planned, as well as for the planned application and use of customer's third party customer(s). Customers should provide appropriate design and operating safeguards to minimize the risks associated with their applications and products. NXP Semiconductors does not accept any liability related to any default, damage, costs or problem which is based on any weakness or default in the customer's applications or products, or

the application or use by customer's third party customer(s). Customer is responsible for doing all necessary testing for the customer's applications and products using NXP Semiconductors products in order to avoid a default of the applications and the products or of the application or use by customer's third party customer(s). NXP does not accept any liability in this respect.

Export control — This document as well as the item(s) described herein may be subject to export control regulations. Export might require a prior authorization from competent authorities.

Evaluation products — This product is provided on an "as is" and "with all faults" basis for evaluation purposes only. NXP Semiconductors, its affiliates and their suppliers expressly disclaim all warranties, whether express, implied or statutory, including but not limited to the implied warranties of non-infringement, merchantability and fitness for a particular purpose. The entire risk as to the quality, or arising out of the use or performance, of this product remains with customer. In no event shall NXP Semiconductors, its affiliates or their suppliers be liable to customer for any special, indirect, consequential, punitive or incidental damages (including without limitation damages for loss of business, business interruption, loss of use, loss of data or information, and the like) arising out of the use of or inability to use the product, whether or not based on tort (including negligence), strict liability, breach of contract, breach of warranty or any other theory, even if advised of the possibility of such damages. Notwithstanding any damages that customer might incur for any reason whatsoever (including without limitation, all damages referenced above and all direct or general damages), the entire liability of NXP Semiconductors, its affiliates and their suppliers and customer's exclusive remedy for all of the foregoing shall be limited to actual damages incurred by customer based on reasonable reliance up to the greater of the amount actually paid by customer for the product or five dollars (US\$5.00). The foregoing limitations, exclusions and disclaimers shall apply to the maximum extent permitted by applicable law, even if any remedy fails of its essential purpose.

Translations — A non-English (translated) version of a document is for reference only. The English version shall prevail in case of any discrepancy between the translated and English versions.

Security — Customer understands that all NXP products may be subject to unidentified or documented vulnerabilities. Customer is responsible for the design and operation of its applications and products throughout their lifecycles to reduce the effect of these vulnerabilities on customer's applications and products. Customer's responsibility also extends to other open and/or proprietary technologies supported by NXP products for use in customer's applications. NXP accepts no liability for any vulnerability. Customer should regularly check security updates from NXP and follow up appropriately. Customer shall select products with security features that best meet rules, regulations, and standards of the intended application and make the ultimate design decisions regarding its products and is solely responsible for compliance with all legal, regulatory, and security related requirements concerning its products, regardless of any information or support that may be provided by NXP. NXP has a Product Security Incident Response Team (PSIRT) (reachable at PSIRT@nxp.com) that manages the investigation, reporting, and solution release to security vulnerabilities of NXP products.

7.3 Trademarks

Notice: All referenced brands, product names, service names and trademarks are the property of their respective owners.

NXP — wordmark and logo are trademarks of NXP B.V.

Tables

Tab. 1.	NXP MDI connector pinout	7	Tab. 4.	PSI5 operation mode details	21
Tab. 2.	Beagle connector pinout	7	Tab. 5.	Example script commands	31
Tab. 3.	DSI3/PSI5 adapter power settings summary	18			

Figures

Fig. 1.	NXP Sensor SPI/I2C Master Kit - SEN-SPI- BOX	3	Fig. 21.	FFV power supply voltage selection	15
Fig. 2.	SEN-SPI-BOX kit contents	4	Fig. 22.	Example of custom GUI selection for SPI interface	16
Fig. 3.	Attaching the SEN-GEN6-SKT board to the SEN-SPI-BOX	5	Fig. 23.	SPI functions for data transfer	17
Fig. 4.	SEN-SPI-BOX overview	6	Fig. 24.	I2C Interface	17
Fig. 5.	SEN-SPI-BOX interfaces	6	Fig. 25.	Transceiver selection	18
Fig. 6.	NXP MDI and Beagle connector pinout	6	Fig. 26.	Enable or disable the DSI3 channel	19
Fig. 7.	Debug cable pinouts	7	Fig. 27.	CRM settings	19
Fig. 8.	Status indicators	8	Fig. 28.	PDCM settings	20
Fig. 9.	Front LED indicators	8	Fig. 29.	PSI5 transceiver interface	20
Fig. 10.	Block diagram	9	Fig. 30.	Denomination of PSI5 operation modes	21
Fig. 11.	NXP Sensor FFV tool setup	10	Fig. 31.	Sensor selection page	22
Fig. 12.	NXP Sensor FFV installation folder	11	Fig. 32.	Advanced features	23
Fig. 13.	NXP Sensor FFV tool installation confirmation	11	Fig. 33.	Register sensor content	23
Fig. 14.	Connecting the kit via USB Type-B cable	12	Fig. 34.	FFV script editor	24
Fig. 15.	Compatible COM Port drivers	12	Fig. 35.	Types of .ffvpkg files	24
Fig. 16.	Select a script in the First Field Verification tool	13	Fig. 36.	Test of an FXLS90422AES inertial sensor	25
Fig. 17.	Open an existing project	13	Fig. 37.	FFV running the test	26
Fig. 18.	Open a compatible sensor without a dedicated package file	14	Fig. 38.	FFV opening the test report	26
Fig. 19.	Open an unsupported device or missing a package	14	Fig. 39.	Example of configuration interface	27
Fig. 20.	FFV compatible device scan	15	Fig. 40.	FFV configuring the stream settings	28
			Fig. 41.	FFV stream information	28
			Fig. 42.	FFV recording the settings	28
			Fig. 43.	Real-time graphing example	29
			Fig. 44.	FFV creating customized scripts	29

Contents

1	Introduction	3	6.5.1.3	Open a test report	26
2	Getting started	4	6.5.1.4	Create a custom test file using C# .Net	27
2.1	Kit contents/packing list	4	6.5.2	Datalogger file	27
2.2	Finding kit resources and information on the NXP website	5	6.5.2.1	Configure the sensor	27
3	Hardware description	5	6.5.2.2	Configure the streaming settings	27
3.1	Kit overview	5	6.5.3	Script file	29
3.2	Pinout	6	6.5.3.1	Create custom scripts	29
3.2.1	NXP MDI connector	7	7	Legal information	32
3.2.2	Beagle connector	7			
3.2.3	Beagle debug cable	7			
3.3	LED indicators	8			
3.3.1	Rear view	8			
3.3.2	Front view	8			
3.4	Block diagram	9			
4	Setting up the FFV Tool kit	10			
4.1	Software installation	10			
4.1.1	Download software	10			
4.1.2	System requirements	10			
4.1.3	Setup	10			
4.2	Prepare the kit	11			
4.2.1	Connect the kit	11			
4.2.2	Launch the software	12			
4.2.2.1	Start	12			
4.2.2.2	Select a project	13			
4.2.2.3	FFV kit search	14			
4.2.2.4	Enable the power supplies	15			
5	Using standard communication protocols	16			
5.1	Native protocols	16			
5.1.1	SPI	17			
5.1.2	I2C	17			
5.1.2.1	I2C scanner	17			
5.1.2.2	Read	18			
5.1.2.3	Write	18			
5.2	Optional protocols	18			
5.2.1	DSI3	18			
5.2.1.1	Command and response mode (CRM)	19			
5.2.1.2	Periodic data collection mode (PDCM)	19			
5.2.1.3	Background diagnostic mode (BDM)	20			
5.2.2	PSI5	20			
6	Using .ffvpkg or predefined sensor packages	22			
6.1	Connect the sensor to the FFV kit	22			
6.2	Scan for sensor	22			
6.3	Configure the sensor	22			
6.3.1	Advanced window for advanced features	22			
6.3.1.1	Register table	23			
6.3.1.2	Custom script	24			
6.4	Open the package	24			
6.5	Use the package files	25			
6.5.1	Test file	25			
6.5.1.1	Configure the test	25			
6.5.1.2	Run the test	25			

Please be aware that important notices concerning this document and the product(s) described herein, have been included in section 'Legal information'.