

EPC9166

12 V Input, 48 V/500 W Output Dual Phase Synchronous Boost Converter Evaluation Board Quick Start Guide

Using EPC2218 Enhancement Mode eGaN[®] FET

Revision 1.0

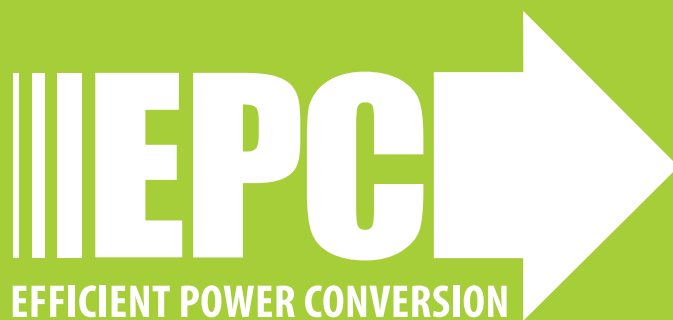

DESCRIPTION

The EPC9166 is a 500 W 12 V to 48 V synchronous Boost converter using eGaN® FET. EPC9166 is designed with **EPC2218** enhancement mode eGaN® FET and ISL81807 two phase analog boost controller with integrated eGaN drivers. EPC9166 main features:

- High efficiency: >96.5% with 12 V input and 48 V output
- Switching frequency: 500 kHz
- Reconfigurable output voltage: 36 V, 48 V, 60 V
- Analog controller with integrated gate driver optimized for eGaN® FET
- Other functions:
 - o Soft start
 - o UVLO
 - o Over-current protection
 - o Power good output



EPC9166 board

REGULATORY INFORMATION

This power module is for evaluation purposes only. It is not a full-featured power module and cannot be used in final products. No EMI test was conducted. It is not FCC approved.

Table 1: Electrical Characteristics (T_A = 25°C)

Symbol	Parameter	Conditions	Min	Typ	Max	Units
V _{IN}	Input voltage		9	12	28	V
V _{UV,Rise}	Input UVLO turn on voltage, rising edge			8.3		
V _{UV,Fall}	Input UVLO turn on voltage, falling edge			7.5		
V _{OUT}	Output voltage		36	48	60	mV
ΔV _{OUT}	Output voltage ripple	Peak to peak			500	
I _{OUT}	Output Current	V _{IN} = 12 V, V _{OUT} = 36 V			16 ^[1]	
		V _{IN} = 12 V, V _{OUT} = 48 V			11 ^[1]	
		V _{IN} = 12 V, V _{OUT} = 60 V			8 ^[1]	
f _s	Switching frequency	Mode = CCM		490		kHz

^[1] The maximum current capability is dependent on thermal conditions. The maximum current shown here is for 1000 LFM or greater. If testing with less than 1000 LFM cooling, the FET temperature should be monitored to ensure the maximum temperature does not exceed the rating in the datasheet.

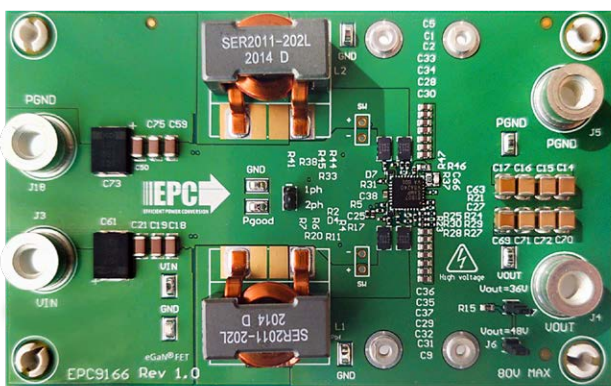

EPC9166 top view

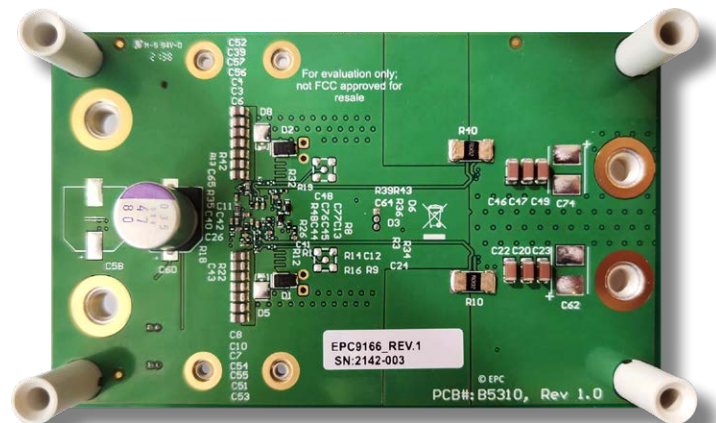

EPC9166 bottom view

CUSTOM CIRCUIT CONFIGURATIONS

Output voltage settings

The EPC9166 output voltage can be configured by table 2.

Table 2: Output voltage settings

Output Voltage	J6	J7
60 V	Open	Open
48 V (default)	Install	Open
36 V	Open	Install

QUICK START PROCEDURE

The demonstration board EPC9166 is easy to set up to evaluate the performance of the EPC2218 eGaN FETs and directly drive from the controller IC. Refer to figure 1 for proper connect and measurement setup and follow the procedure below:

1. Configure the jumpers for phase mode the output voltage setting per figure 1 and table 2. The phase mode jumper J8 sets the 180° phase shift between the two phases in its default location (1). The output voltage is set by jumper J6 and J7 and the default location (2) sets the output voltage at 48 V.
2. With power off, connect the input power supply between VIN (J3) and GND (J18). A shunt can be inserted to measure input current.
3. With power off, connect a programmable load as needed between VOUT (J4) and GND (J5) as shown in figure 1.
4. Turn on the supply voltage to 12 V and **keep the load OFF**. The converter will not start up until the input voltage is above 9 V. The converter is not designed to start up with large load.
5. Check the output voltage is regulated to 48 V to make sure the board is functional. If 48 V is not observed, please carefully re-examine the circuit connections.
6. Activate the programmable load and set to the desired current ensuring the maximum current does not exceed the maximum ratings.
7. Once operational, adjust the bus voltage and load current within the allowed operating range and observe the output switching behavior. For measuring switch node waveforms, please use probes without ground lead and measure as close to the FET. An unpopulated two pin connector is designed for easy measurement. **Please note polarity.**
8. For shutdown, please follow steps in reverse. For custom configuration please refer the custom configuration section.

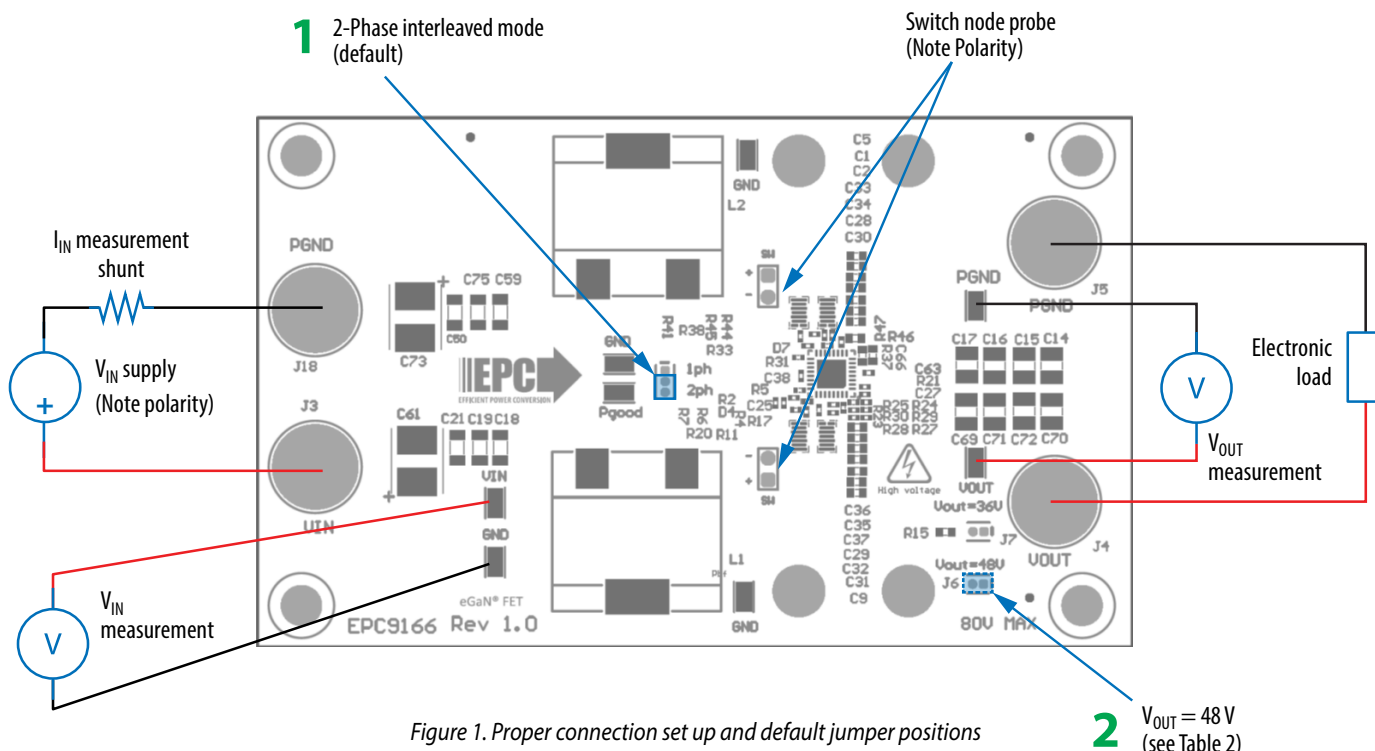

Figure 1. Proper connection set up and default jumper positions

ELECTRICAL PERFORMANCE

Typical efficiency and power loss

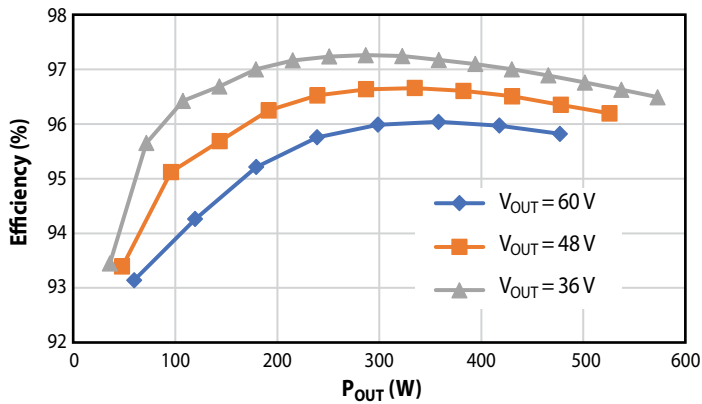

Figure 2 (a): Typical efficiency for different output voltage (12 V input, 1000 LFM air flow)

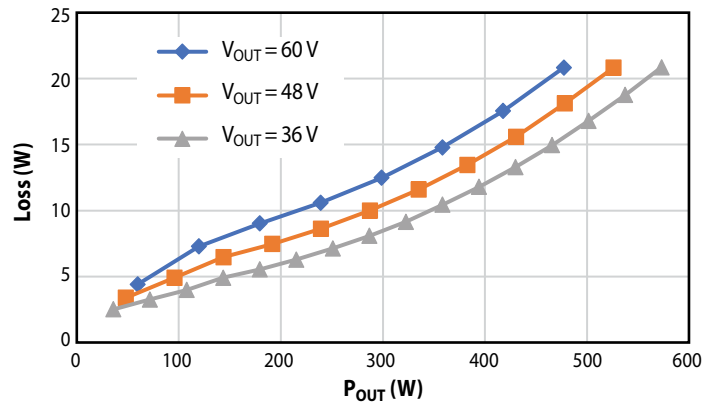

Figure 2(b): Typical losses for different output voltage (12 V input, 1000 LFM air flow)

Typical output voltage ripple

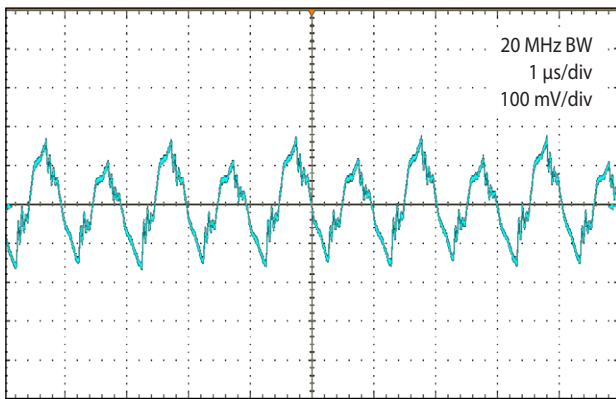

Figure 3: Typical output voltage ripple: $V_{IN} = 12$ V, $V_{OUT} = 48$ V, $I_{OUT} = 10$ A

Typical transient response

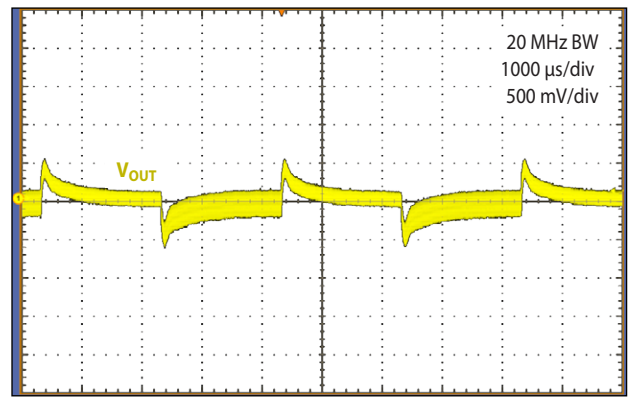

Figure 4: Typical transient response: $V_{IN} = 12$ V, $V_{OUT} = 48$ V, output 5 A to 10 A, $di/dt = 2$ A/μs

Typical soft start waveforms

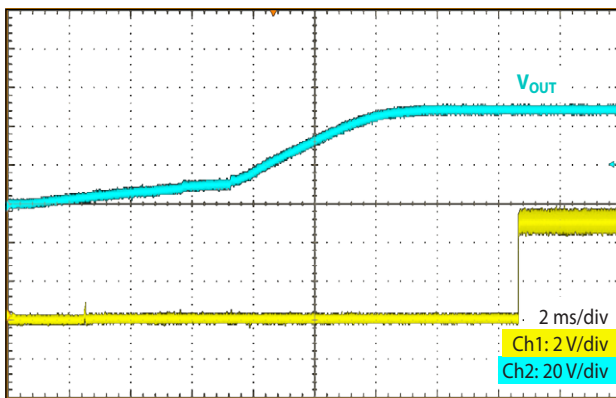

Figure 5: Soft Start waveform: $V_{IN} = 12$ V, $V_{OUT} = 48$ V

Typical load regulation

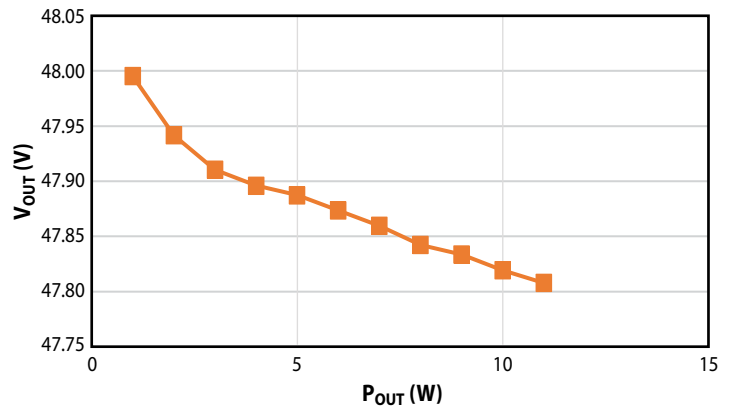

Figure 6: Typical load regulation: $V_{IN} = 12$ V, $V_{OUT} = 48$ V

Typical switch node waveform

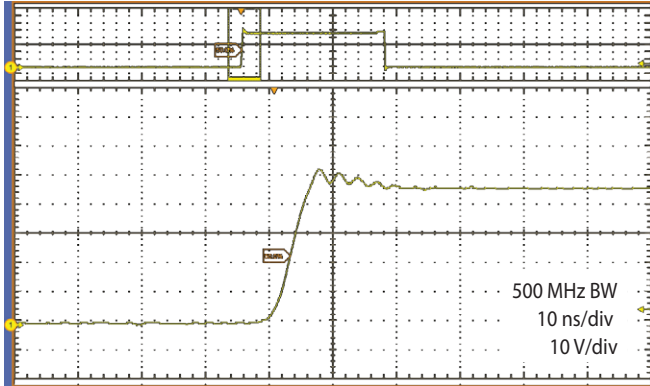

Figure 7(a): Typical switch node waveform (rising edge):
 $V_{IN} = 12\text{ V}$, $V_{OUT} = 48\text{ V}$, $I_{OUT} = 5\text{ A}$

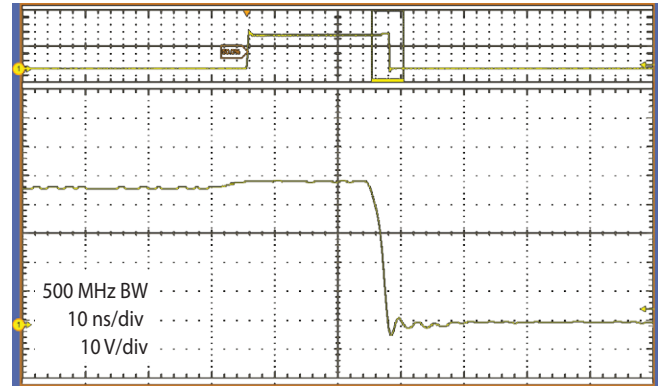

Figure 7(b): Typical switch node waveform (falling edge):
 $V_{IN} = 12\text{ V}$, $V_{OUT} = 48\text{ V}$, $I_{OUT} = 5\text{ A}$

Typical thermal performance

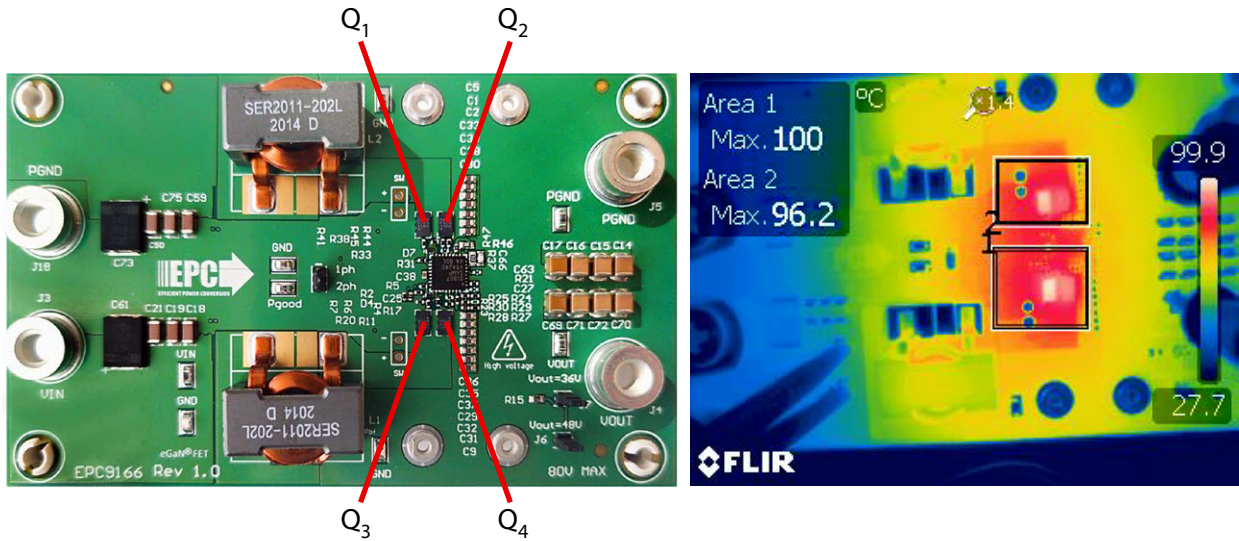

Figure 8: Typical thermal performance:
 $V_{IN} = 12\text{ V}$, $V_{OUT} = 48\text{ V}$, $I_{OUT} = 10\text{ A}$, 400 LFM air flow

Input UVLO adjustment

The input UVLO threshold voltage can be set by R6 and R7 as shown in Figure 9. The default values of V_{uv} are listed in table 1. If needed, a new UVLO voltage and hysteresis can be set by changing R6 and R7 using equation (1) and (2). Please refer to [ISL81807 datasheet](#) for more information.

$$V_{uvrise} = \frac{1.8(R6+R7) - 2.8 \times 10^{-6} R6R7}{R7} \quad (1)$$

$$V_{uvfall} = \frac{1.8(R6+R7) - 6.8 \times 10^{-6} R6R7}{R7} \quad (2)$$

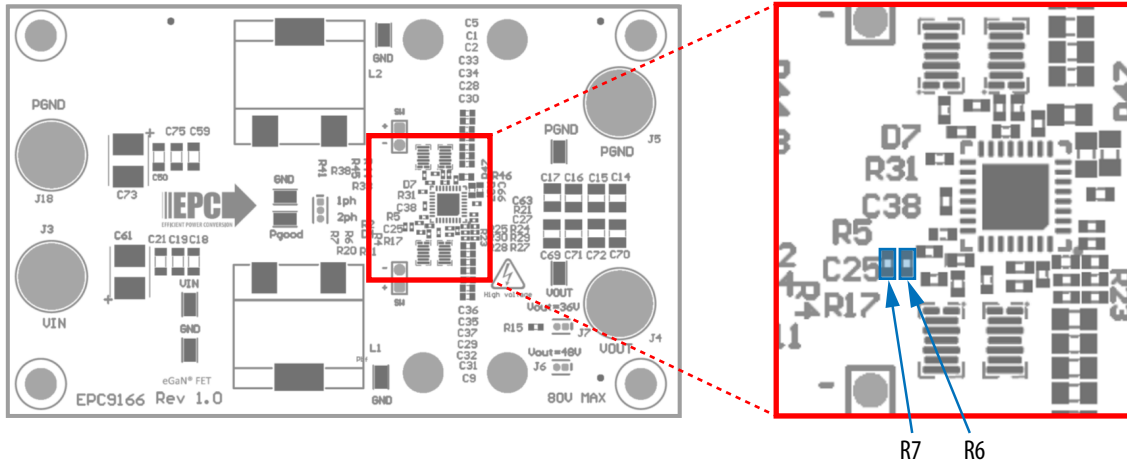

Figure 9: EPC9166 ULVO settings: location of R6 & R7

Switching frequency adjustment

The switching frequency is set by the value of R35 with the frequency given in equation (3). The default frequency is 500 kHz. The location of R35 is shown in Fig 10. Refer to [ISL81807 datasheet](#) for more information.

$$f_s \text{ (MHz)} \approx \frac{34 \text{ (MHz)}}{R35 \text{ (k}\Omega)} \quad (3)$$

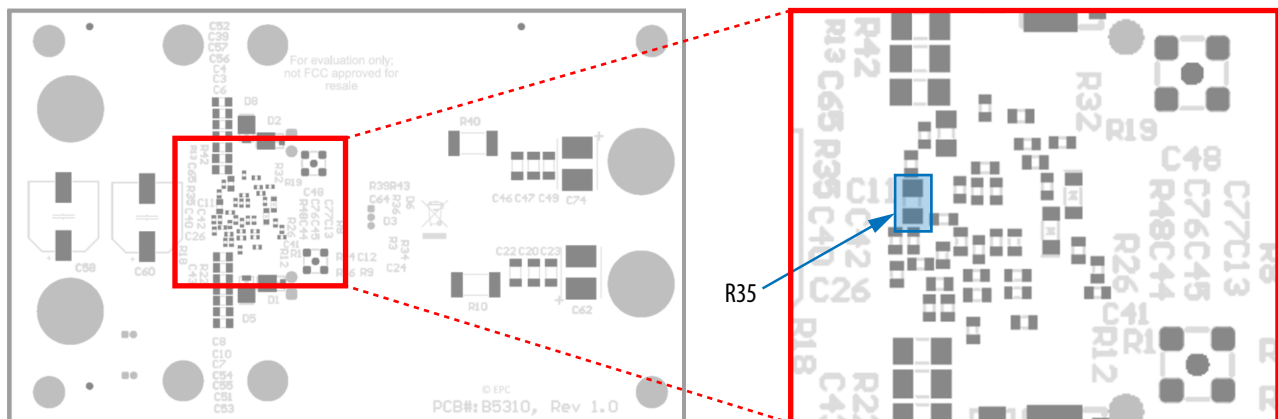

Figure 10: EPC9166 frequency setting: location of R35

THERMAL MANAGEMENT (Optional)

The EPC9166 is intended for bench evaluation at room ambient temperatures and under forced air convection cooling. The addition of heatsink along with forced air cooling is not required but can significantly improve the heat dissipation from the FETs from the top side and increase the current capacity of these devices. A TIM is required between the FETs and the heatsink. The choice of TIM needs to consider the following characteristics:

The EPC9166 board is equipped with four mechanical spacers (S1, S2, S3, S4) that can be used to easily attach a standard eighth-brick converter heatsink as shown in figure 11, and only requires a thermal interface material (TIM), a heatsink, and screws.

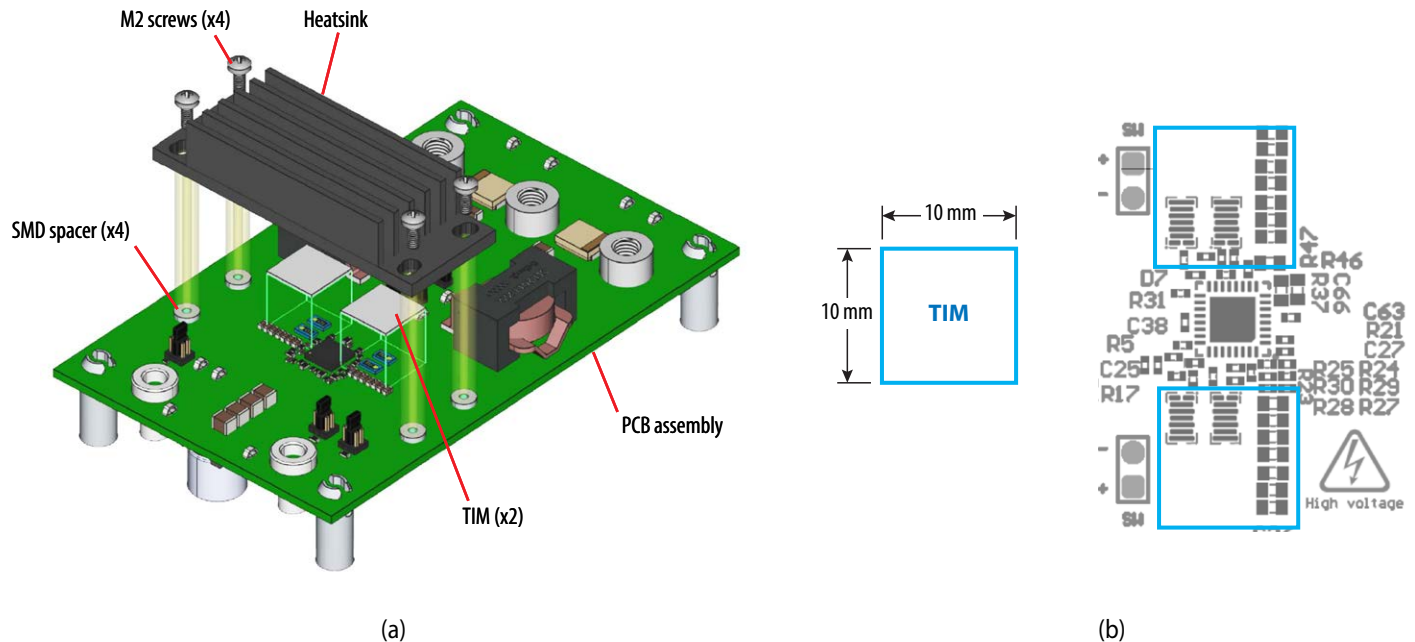

Figure 11: Exploded 3D assembly of heat sink installment (a) and dimensions and locations of TIM material (b)

The following heat sink is recommended for EPC9166:

- Wakefield P/N : 567-45AB

A TIM is required between the FETs and the heatsink. The choice of TIM needs to consider the following characteristics:

- **Mechanical compliance** – During the attachment of the heat spreader, the TIM underneath is compressed from its original thickness to the vertical gap distance between the spacers and the FETs. This volume compression exerts a force on the FETs. A maximum compression of 2:1 is recommended for maximum thermal performance and to constrain the mechanical force which maximizes thermal mechanical reliability.
- **Electrical insulation** – The backside of the eGaN FET is a silicon substrate that is connected to source and thus the upper FET in a half-bridge configuration is connected to the switch-node. To prevent short-circuiting the switch-node to the grounded thermal solution, the TIM must be of high dielectric strength to provide adequate electrical insulation in addition to its thermal properties.
- **Thermal performance** – The choice of thermal interface material will affect the thermal performance of the thermal solution. Higher thermal conductivity materials is preferred to provide higher thermal conductance at the interface.

EPC recommends the following thermal interface materials (TIM) for EPC9166:

- **t-Global** P/N: TG-A1780 X 0.5 mm (highest conductivity of 17.8 W/m·K)
- **t-Global** P/N: TG-A620 X 0.5 mm (moderate conductivity of 6.2 W/m·K)

NOTE. The EPC9166 development board does not have any current or thermal protection on board.

For more information regarding the thermal performance of EPC eGaN FETs, please consult: D. Reusch and J. Glaser, *DC-DC Converter Handbook, a supplement to GaN Transistors for Efficient Power Conversion*, First Edition, Power Conversion Publications, 2015.

MECHANICAL SPECIFICATIONS

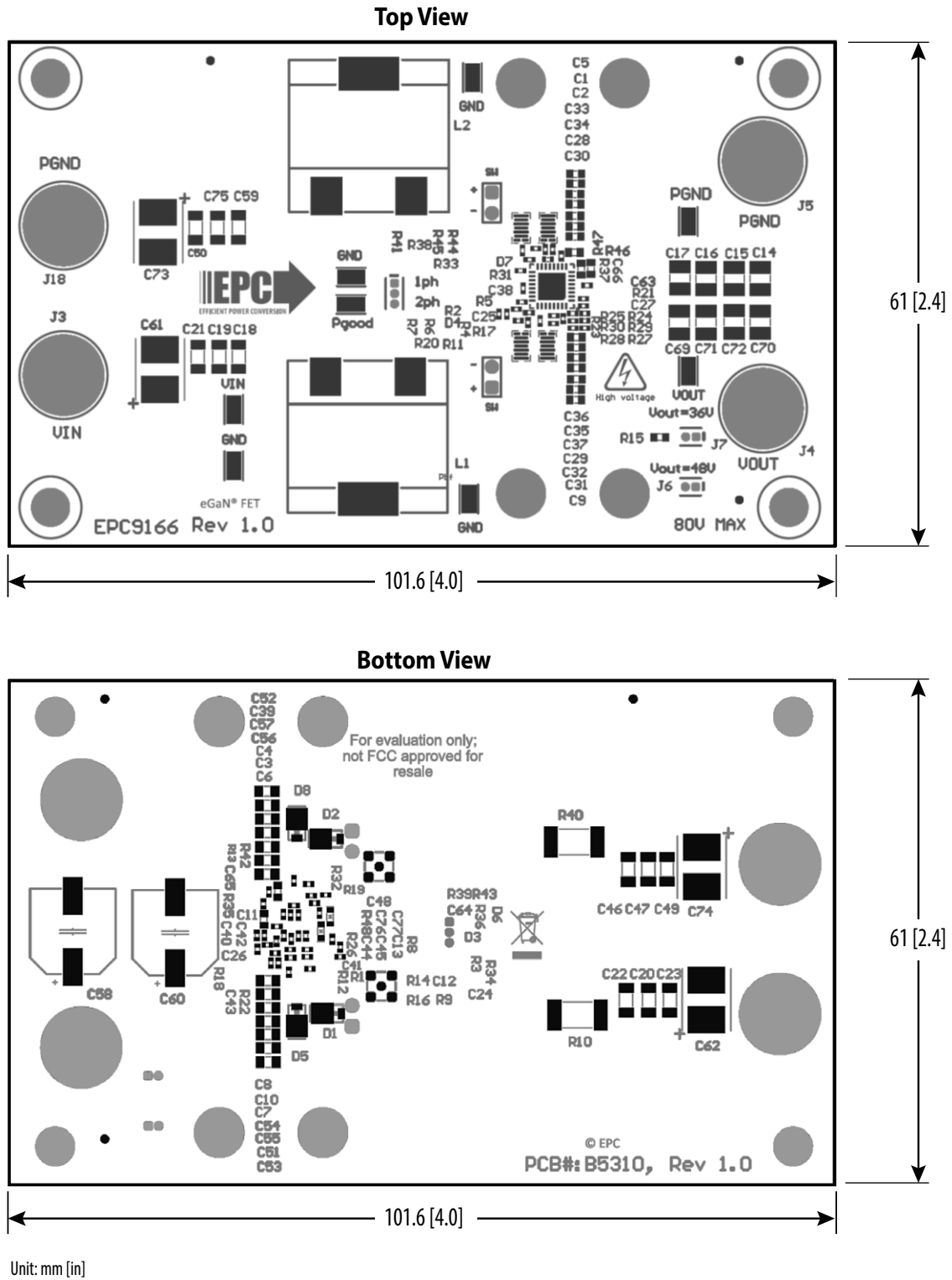

Figure 12: Mechanical dimensions

Table 3: Bill of Materials

Item	Qty	Reference	Part Description	Manufacturer	Part #
1	14	C1, C2, C5, C9, C28, C29, C30, C31, C32, C33, C34, C35, C36, C37	CAP CER 0.22 μ F 100 V X7S 0603	Taiyo Yuden	HMK107C7224KAHTE
2	14	C3, C4, C6, C7, C8, C10, C39, C51, C52, C53, C54, C55, C56, C57	CAP CER 1 μ F 100 V X7S 0805	TDK	C2012X7S2A105K125AB
3	2	C11, C38	CAP CER 10 μ F 10 V X5R 0402	Samsung	CL05A106MP8NUB8
4	2	C12, C64	CAP CER 0.1 μ F 25 V X7R 0402	TDK	C1005X7R1E104K050BB
5	8	C14, C15, C16, C17, C69, C70, C71, C72	CAP CER 10 μ F 100 V X7S 1210	Murata	GRM32EC72A106KE05L
6	12	C18, C19, C20, C21, C22, C23, C46, C47, C49, C50, C59, C75	CAP CER 22 μ F 35 V JB 1206	TDK	C3216JB1V226M160AC
7	1	C24	CAP CER 10000 PF 25 V X7R 0402	KEMET	C0402C103K3RACTU
8	1	C26	CAP CER 0.033 μ F 50 V X7R 0402	TDK	C1005X7R1H333K050BB
9	1	C40	CAP CER 0.047 μ F 50 V X7R 0402	TDK	C1005X7R1H473K050BB
10	1	C41	CAP CER 1000 PF 50 V X7R 0402	Yageo	CC0402KRX7R9BB102
11	1	C42	CAP CER 220PF 100 V C0G 0402	TDK	C1005C0G2A221J050BA
12	5	C44, C45, C65, C76, C77	CAP CER 10000 PF 50 V X7R 0402	KEMET	C0402C103K5RACTU
13	1	C58	CAP ALUM 47 μ F 20% 80 V SMD	Panasonic	805XV47M
14	1	C60	CAP ALUM 47 μ F 20% 80 V SMD	Panasonic	805XV47M
15	2	C61, C73	CAP TANT POLY 100 μ F 35 V 2924	KEMET	T523H107M035APE070
16	2	C62, C74	CAP TANT POLY 100 μ F 35 V 2924	KEMET	T523H107M035APE070
17	1	C66	CAP CER 820PF 50 V C0G/NP0 0603	KEMET	C0603C821J5GACTU
18	2	D1, D2	DIODE SCHOTTKY 100V 2A DO220AA	Vishay	SS2PH10-M3
19	2	D3, D6	DIODE GEN PURP 80V 200mA SC79-2	Infineon	BAS1602VH6327XTSA1
20	2	D4, D7	DIODE ZENER 5.1V 250 mW 2DFN	Diodes Inc.	BZT52C5V1LP-7
21	4	J3, J4, J5, J18	RedCube M5	Würth	7466005R
22	2	J6, J7	Header Male 50mil 1 row, 2 pos., Thru Vert.	Sullins	GRPB021VWVN-RC
23	1	J8	Header Male 50mil 1 row, 3 pos., Thru Vert.	Sullins	GRPB031VWVN-RC
24	3	JP1, JP2, JP3	50mil Jumper Black withHandle	Harwin Inc	M50-2000005
25	2	L1, L2	2 μ H, \pm 20%, 1.34 m Ω , 40A	CoilCraft	SER2011-202MLB
26	4	Q1, Q2, Q3, Q4	100 V 60 A 3.2 m Ω	EPC	EPC2218
27	1	R2	RES 4.7 Ω 1% 1/16 W 0402	Stackpole	RMCF0402FT4R70
28	3	R3, R4, R38,R41,R11	RES SMD 0 Ω JUMPER 1/10 W 0402	Panasonic	ERJ-2GE0R00X
29	2	R5, R31	RES SMD 10 Ω 1% 1/10 W 0402	Panasonic	ERJ-2RKF10R0X
30	2	R6, R28	RES 200 K Ω 1% 1/10 W 0402 SMD	Panasonic	ERJ-U02F2003X
31	1	R7	RES 51K Ω 1% 1/16 W 0402	stackpole	RMCF0402FT51K0
32	4	R8, R36	RES 2.05 Ω 1% 1/16 W 0402	Stackpole	RMCF0402FT2R0
33	2	R10, R40	RES 0.002 Ω 1% 2W 2512	Bourns	CRE2512-FZ-R002E-2
34	2	R13, R34	RES SMD 10K Ω 5% 1/16 W 0402	Yageo	RC0402JR-0710KL
35	1	R15	RES SMD 10K Ω 5% 1/10 W 0603	Yageo	RC0603JR-0710KL
36	4	R16, R17, R44, R45	RES SMD 1 Ω 1% 1/16 W 0402	ROHM	MCR01MRT1JR0
37	3	R20, R22, R43	RES SMD 5.6K Ω 1% 1/10 W 0402	Panasonic	ERJ-2RKF5601X
38	1	R21	RES SMD 10K Ω 1% 1/10 W 0402	Panasonic	ERJ-2RKF1002X
39	1	R23	RES SMD 18K Ω 0.1% 1/16 W 0402	Panasonic	ERA-2AEB183X
40	1	R24	RES SMD 47K Ω 0.1% 1/16 W 0402	Yageo	AT0402BRE0747KL
41	1	R25	RES SMD 27K Ω 0.1% 1/16 W 0402	Yageo	ERA-2AEB273X
42	1	R26	RES SMD 1K Ω 1% 1/10 W 0402	Panasonic	ERJ-2RKF1001X
43	1	R27	91 k Ω s \pm 0.1% 0.063 W, 1/16 W Chip Resistor 0402 (1005 Metric) - Thin Film	Yageo	RT0402BRD0791KL
44	1	R29	RES 33 K Ω 0.1% 1/10 W 0402	Vishay	TNPW040233K0BEED
45	1	R30	RES SMD 75K Ω 0.1% 1/16 W 0402	Yageo	RT0402BRE0775KL
46	1	R35	RES SMD 68K Ω 0.1% 1/10 W 0603	Yageo	RT0603BRD0768KL
47	1	R37	RES SMD 2.7K Ω 0.1% 1/10 W 0603	Yageo	ERA-3AEB272V
48	2	R42, R46	RES SMD 49.9K Ω 1% 1/10 W 0603	Yageo	RC0603FR-0749K9L
49	1	R47	RES 36 K Ω 1% 1/10 W 0402 SMD	Panasonic	ERJ-U02F3602X
50	1	R48	RES SMD 100K Ω 1% 1/16 W 0402	Yageo	RT0402FRE07100KL

Table 3: Bill of Materials (continued)

Item	Qty	Reference	Part Description	Manufacturer	Part #
51	4	SO1, SO2, SO3, SO4	BRD SPT SNAP FIT SCREW MNT 5/8"	Keystone	8834
52	4	SO5, SO6, SO7, SO8	Round Standoff Threaded M2x0.4 Steel 0.039" (1.00 mm)	Würth	9774010243R
53	8	TP1, TP2, TP4, TP5, TP9, TP10, TP11, TP12	HookUP SMD	Keystone	5015
54	1	U1	80 V 2-phase boost Controller with Drivers	Renesas	ISL81807

Table 4: Optional Components

Item	Qty	Reference	Part Description	Manufacturer	Part #
1	2	J2, J15	MMCX Jack SMD Vert.	Molex	734152063
2	2	D5, D8	DIODE SCHOTTKY 100 V 2 A DO220AA	Vishay	SS2PH10-M3
3	1	HS1	8thB Heatsink 55x21x11mm Horz. Fin	Wakefield	567-45AB
4	2	R1,R19	Jumper	Panasonic	ERJ-2GE0R00X

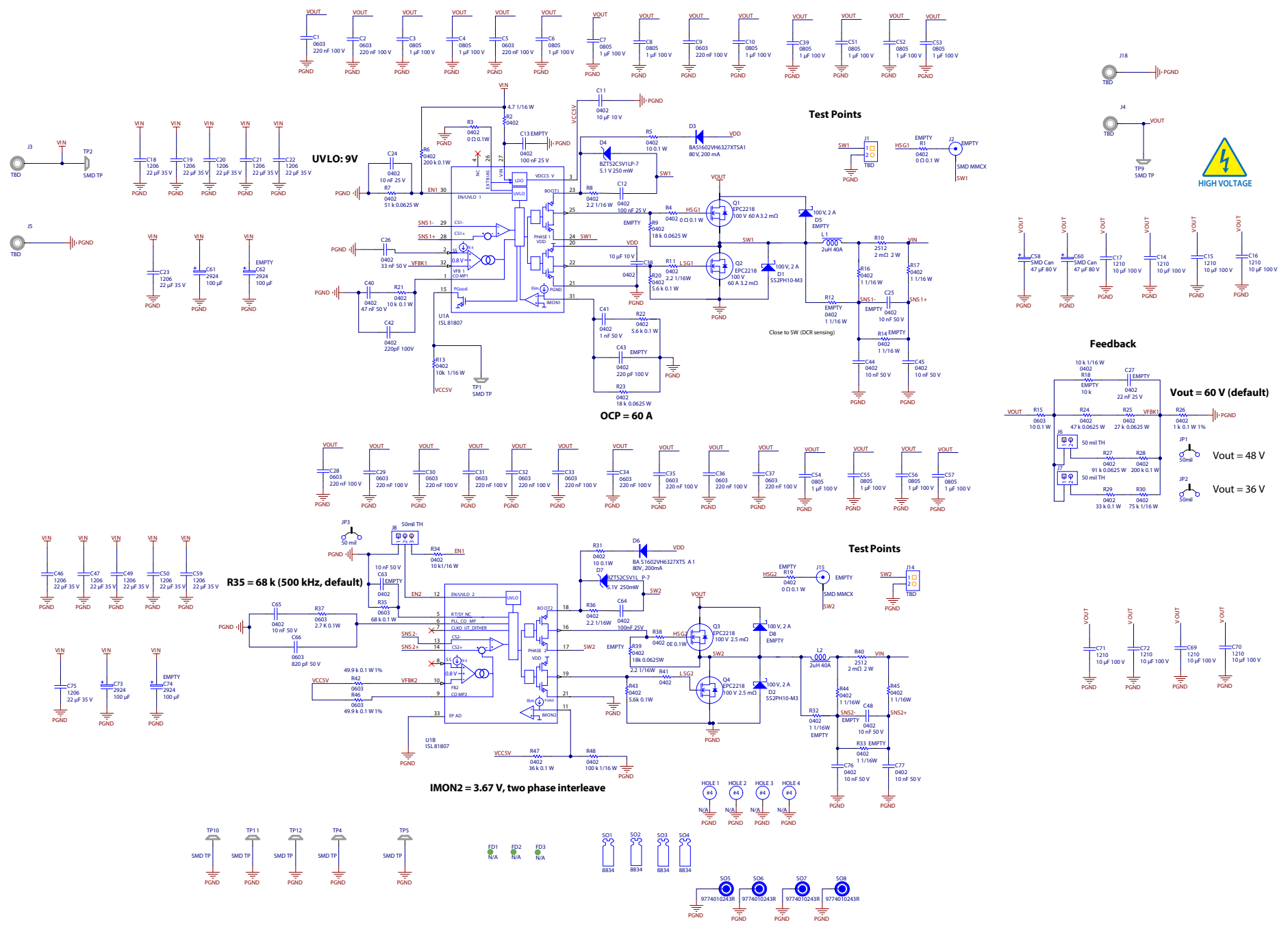

Figure 13: EPC9166 main schematic

For More Information:

Please contact info@epc-co.com
or your local sales representative

Visit our website:
www.epc-co.com

Sign-up to receive
EPC updates at
bit.ly/EPCupdates
or text "EPC" to 22828



EPC Products are distributed through Digi-Key.
www.digikey.com

Demonstration Board Notification

The EPC9166 board is intended for product evaluation purposes only. It is not intended for commercial use nor is it FCC approved for resale. Replace components on the Evaluation Board only with those parts shown on the parts list (or Bill of Materials) in the Quick Start Guide. Contact an authorized EPC representative with any questions. This board is intended to be used by certified professionals, in a lab environment, following proper safety procedures. Use at your own risk.

As an evaluation tool, this board is not designed for compliance with the European Union directive on electromagnetic compatibility or any other such directives or regulations. As board builds are at times subject to product availability, it is possible that boards may contain components or assembly materials that are not RoHS compliant. Efficient Power Conversion Corporation (EPC) makes no guarantee that the purchased board is 100% RoHS compliant.

The Evaluation board (or kit) is for demonstration purposes only and neither the Board nor this Quick Start Guide constitute a sales contract or create any kind of warranty, whether express or implied, as to the applications or products involved.

Disclaimer: EPC reserves the right at any time, without notice, to make changes to any products described herein to improve reliability, function, or design. EPC does not assume any liability arising out of the application or use of any product or circuit described herein; neither does it convey any license under its patent rights, or other intellectual property whatsoever, nor the rights of others.