

MAX17129/MAX17149

Low-Cost, 6-String WLED Drivers with Quick-PWM Step-Up Converter

General Description

The MAX17129/MAX17149 are high-efficiency drivers for white LEDs. They are designed for small- to medium-sized LCDs that employ an array of LEDs as the light source. An internal switch step-up controller with Quick-PWM™ drives the LED array, which can be configured for up to 6 strings in parallel and either 11 LEDs (MAX17129) or 6 LEDs in series (MAX17149) per string. Each string is terminated with a ballast that achieves $\pm 2\%$ current-regulation accuracy, ensuring even LED brightness and provides an adjustable 10mA to 45mA full-scale LED current. The devices have a wide input voltage range of 6V to 26V. The MAX17129 integrates an LDO to simplify applications that have a single high-voltage supply. The devices also feature a low-input-voltage mode for applications that have a 3V to 5.5V supply voltage.

The devices support both PWM and hybrid dimming mode. In PWM dimming mode, the external PWM signal directly controls the brightness of LEDs. The dimming frequency ranges from 100Hz to 25kHz with 400ns minimum on-time. In hybrid dimming mode, the LED current amplitude can be adjusted to 25% of full-scale LED current to improve system efficiency when brightness is low.

The devices have multiple features to protect the controller from fault conditions. Separate voltage-feedback loops limit the output voltage to safe operation. The open- and short-LED detection shuts down the faulty string while keeping other strings operating normally.

The devices feature cycle-by-cycle current limit on the internal switch to provide consistent operation and soft-start capability. If the devices are in current-limit condition, the step-up converter is latched off after an internal timer expires. A thermal-shutdown circuit provides another level of protection and prevents ICs from damage.

The ICs' step-up controller features an internal 0.25 Ω (typ), 48V (max) power MOSFET with lossless current sense and accurate cycle-by-cycle current limit. The Quick-PWM control architecture provides fast load-transient response without requiring an external loop compensation component, simplifies the external circuitry, and saves board area. The Quick-PWM control scheme has constant off-time and adjustable pseudo-fixed frequency, which enables a wide variety of applications that can trade off component size for operating frequency. Low feedback voltage at each LED string (275mV typ at 20mA LED current) helps reduce power loss and improve efficiency.

The ICs are available in a 16-pin, thin QFN package with 0.5mm lead spacing. The package is 3mm x 3mm with a maximum thickness of 0.8mm for ultra-thin LCD panel design.

Features

- Independently Controlled Dual Paths
- 3V to 26V Input Supply Voltage
- Up to Six Parallel Strings of Multiple Series-Connected LEDs
- Step-Up Regulator with Quick-PWM Control Scheme
- Two-Level Selectable Switching Frequency
- 0.25 Ω Internal HV Power MOSFET (48V max)
- Low String Feedback Voltage: 275mV at 20mA LED Current
- Full-Scale LED Current Adjustable from 10mA to 45mA
- $\pm 2\%$ Current-Regulation Accuracy Between Strings
- Support PWM and Hybrid Dimming Mode
- 100:1 Dimming Ratio
- 100Hz to 25kHz Dimming Frequency for PWM Dimming Mode
- Open- and Short-LED Protection
- Output-Overvoltage Protection
- Small 16-Pin, 3mm x 3mm Thin QFN Package

Applications

- Notebook, Subnotebook, and Tablet Computer Displays
- Handy Terminals

Ordering Information

PART	TEMP RANGE	PIN-PACKAGE
MAX17129ETE +	-40°C to +85°C	16 Thin QFN-EP*
MAX17149ETE+	-40°C to +85°C	16 Thin QFN-EP*

+Denotes lead(Pb)-free/RoHS-compliant package.

*EP = Exposed pad.

Simplified Operating Circuit appears at end of data sheet.

Quick-PWM is a trademark of Maxim Integrated Products, Inc.

Absolute Maximum Ratings

FSEL, IN, BRT, EN to GND-0.3V to +28V
 FB₋, LX, OVP to PGND.....-0.3V to +48V
 PGND to GND.....-0.3V to +0.3V
 V_{CC} to GND.....-0.3V to +6V
 ISET to GND..... -0.3V to V_{CC} + 0.3V
 LX Switch Continuous RMS Current.....1.6A
 Continuous Power Dissipation (T_A = +70°C)
 16-Pin Thin QFN (derate 14.7mW/°C above +70°C)..1176mW

Operating Temperature Range.....-40°C to +85°C
 Junction Temperature.....+150°C
 Storage Temperature Range.....-60°C to +150°C
 ESD
 HBM.....±2kV
 MM.....±200V
 Lead Temperature (soldering, 10s).....+300°C
 Soldering Temperature (reflow).....+260°C

Stresses beyond those listed under "Absolute Maximum Ratings" may cause permanent damage to the device. These are stress ratings only, and functional operation of the device at these or any other conditions beyond those indicated in the operational sections of the specifications is not implied. Exposure to absolute maximum rating conditions for extended periods may affect device reliability.

Electrical Characteristics

(Circuit of Figure 1. V_{IN} = 12V, R_{ISET} = 100kΩ, T_A = 0°C to +85°C, unless otherwise noted. Typical values are at T_A = +25°C.) (Note 1)

PARAMETER	CONDITIONS	MIN	TYP	MAX	UNITS
IN Input Voltage Range	IN not connected to V _{CC}	6		26	V
	IN connected to V _{CC}	3.0		5.5	
IN Standby Current	V _{EN} = 3V, V _{IN} = 26V, no external loads		3.2	4	mA
	V _{EN} = 0V, V _{IN} = 26V		0.1	5	µA
V _{CC} Output Voltage	V _{EN} = 3V, 0 < I _{VCC} < 10mA	3.6	3.8	4.0	V
V _{CC} Current Limit	V _{CC} is forced to 3.5V; IN not connected to V _{CC}	15	30	45	mA
V _{CC} UVLO Threshold	Rising edge, typical hysteresis = 100mV	2.75	2.8	2.85	V
IN UVLO Threshold	Rising edge, typical hysteresis = 100mV; IN not connected to V _{CC}	5.5	5.75	5.9	V
STEP-UP CONVERTER					
LX On-Resistance	100mA from LX to PGND		250	500	mΩ
LX Leakage Current	V _{LX} = 40V, T _A = +25°C		0.05	1	µA
Off-Time	FSEL = GND, V _{IN} = 12V, V _{OVP} = 22V	450	500	550	ns
	FSEL = V _{CC} , V _{IN} = 12V, V _{OVP} = 22V	900	1000	1100	
LX Peak Current Limit	Duty cycle = 75%	2.5	3	3.5	A
Minimum On-Time			50		ns
Minimum Output Regulation Voltage	MAX17129 only	15	16.5	18	V
	MAX17149 only	6.8	8.3	9.8	V
Maximum Output Regulation Voltage	MAX17129 only	41.5	43	44.5	V
	MAX17149 only	23.9	25.4	26.9	V
INPUT LEAKAGE/BIAS CURRENTS					
EN Bias Current	0.3V < V _{EN} < 3.5V, T _A = +25°C			6	µA
	4.1V < V _{EN} < 26V, T _A = +25°C			110	
BRT Bias Current	0.3V < V _{BRT} < 3.5V, T _A = +25°C			15	µA
	4.1V < V _{BRT} < 26V, T _A = +25°C			2000	
EN Input Impedance		750	1500		kΩ
OVP Input Current	MAX17129 only; V _{OVP} = 40V, V _{FB} = 0.75V		15	50	µA
	MAX17149 only; V _{OVP} = 20V, V _{FB} = 0.75V		7.5	25	µA
FSEL Bias Current	0.3V < V _{FSEL} < 3.5V, T _A = +25°C			6	µA
	4.1V < V _{FSEL} < 26V, T _A = +25°C			2000	

Electrical Characteristics (continued)(Circuit of Figure 1. $V_{IN} = 12V$, $R_{ISET} = 100k\Omega$, $T_A = 0^\circ C$ to $+85^\circ C$, unless otherwise noted. Typical values are at $T_A = +25^\circ C$.) (Note 1)

PARAMETER	CONDITIONS	MIN	TYP	MAX	UNITS
LED CURRENT SOURCE					
ISET Resistance Range		44		250	k Ω
Full-Scale FB_ Output Current	$R_{ISET} = 44.44k\Omega$	43.3	45	47.7	mA
	$R_{ISET} = 66.66k\Omega$	29.1	30	30.9	
	$R_{ISET} = 100k\Omega$	19.4	20	20.6	
	$R_{ISET} = 133.33k\Omega$	14.55	15	15.45	
	$R_{ISET} = 200k\Omega$	9.65	10	10.35	
	$R_{ISET} = 100k\Omega$, hybrid dimming mode	4.4	5	5.6	
	$R_{ISET} = 250k\Omega$, hybrid dimming mode	1.4	2	2.6	
ISET Output Voltage		1.225	1.250	1.275	V
Current Regulation Between Strings	$I_{FB} = 30mA$	-1.5		+1.5	%
	$I_{FB} = 20mA$	-2.0		+2.0	
	$I_{FB} = 15mA$	-2.0		+2.0	
	$I_{FB} = 10mA$	-2.75		+2.75	
	$I_{FB} = 5mA$, hybrid dimming mode	-6.0		+6.0	
	$I_{FB} = 2mA$, hybrid dimming mode	-15.0		+15.0	
Minimum FB_ Regulation Voltage	$R_{ISET} = 66.66k\Omega$, 100% duty cycle		375	550	mV
	$R_{ISET} = 100k\Omega$, 100% duty cycle		275	365	
	$R_{ISET} = 133.33k\Omega$, 100% duty cycle		200	275	
	$R_{ISET} = 200k\Omega$, 100% duty cycle		125	200	
FB_ On-Resistance	$V_{FB} = 50mV$			20	Ω
FB_ Leakage Current	$V_{FB} = 28V$, $T_A = +25^\circ C$, $EN = 0V$, $V_{OVP} = 28V$		0.05	1	μA
	$V_{FB} = 40V$, $T_A = +25^\circ C$, $EN = 0V$, $V_{OVP} = 40V$		2.5	5	
FB_ On-Time		300			ns
BRT Input High Level		2.1			V
BRT Input Low Level				0.8	V
BRT Dimming Frequency		0.1		25	kHz
EN Input High Level	MAX17129/MAX17149 enabled, PWM dimming mode	2.1			V
	MAX17129/MAX17149 enabled, hybrid dimming mode	1.4		1.8	
EN Input Low Level				0.8	V
FAULT PROTECTION					
OVP Overvoltage	Rising edge, hysteresis = 1.8V	44.1	45.1	46.1	V
FB_ Check LED Source Current		0.60	0.665	0.73	mA
FB_ Check LED Time	Sequence for 6 channels		1		ms
FB_ Open LED Threshold			500	700	mV
FB_ Overvoltage Threshold		6.7	8.0	9.6	V
Thermal-Shutdown Threshold	(Note 2)		+160		$^\circ C$
Thermal-Shutdown Hysteresis	(Note 2)		15		$^\circ C$
BOOST FREQUENCY SELECTION FSEL					
FSEL Input High Level	Select $f_{SW} = 500kHz$	2.1			V
FSEL Input Low Level	Select $f_{SW} = 1000kHz$			0.8	V

Electrical Characteristics

(Circuit of Figure 1. $V_{IN} = 12V$, $R_{ISET} = 100k\Omega$, $T_A = -40^{\circ}C$ to $+85^{\circ}C$, unless otherwise noted.) (Note 1)

PARAMETER	CONDITIONS	MIN	TYP	MAX	UNITS
IN Input Voltage Range	IN not connected to V_{CC}	6		26	V
	IN = V_{CC}	3		5.5	
IN Quiescent Current	$V_{EN} = 3V$, $V_{IN} = 26V$, no external loads			4	mA
	$V_{EN} = 0V$, $V_{IN} = 26V$			5	μA
V_{CC} Output Voltage	$V_{EN} = 3V$, $0 < I_{VCC} < 10mA$	3.6		4.0	V
V_{CC} Current Limit	V_{CC} is forced to 3.5V; IN not connected to V_{CC}	15		45	mA
V_{CC} UVLO Threshold	Rising edge, typical hysteresis = 100mV	2.75		2.85	V
IN UVLO Threshold	Rising edge, typical hysteresis = 100mV; IN not connected to V_{CC}	5.5		5.9	V
STEP-UP CONVERTER					
LX On-Resistance	100mA from LX to PGND			500	m Ω
LX Leakage Current	$V_{LX} = 40V$, $T_A = +25^{\circ}C$			1	μA
Off-Time	FSEL = GND $V_{IN} = 12V$, $V_{OVP} = 22V$	450		550	ns
	FSEL = V_{CC} , $V_{IN} = 12V$, $V_{OVP} = 22V$	900		1100	
LX Peak Current Limit	Duty cycle = 75%	2.5		3.65	A
Minimum Output Regulation Voltage	MAX17129 only	15		18	V
	MAX17149 only	6.8		9.8	V
Maximum Output Regulation Voltage	MAX17129 only	41.5		44.5	V
	MAX17149 only	23.9		26.9	V
INPUT LEAKAGE/BIAS CURRENTS					
EN Bias Current	$0.3V < V_{EN} < 3.5V$, $T_A = +25^{\circ}C$			6	μA
	$4.1V < V_{EN} < 26V$, $T_A = +25^{\circ}C$			110	
BRT Bias Current	$0.3V < V_{BRT} < 3.5V$, $T_A = +25^{\circ}C$			15	μA
	$4.1V < V_{BRT} < 26V$, $T_A = +25^{\circ}C$			2000	
EN Input Impedance		750			k Ω
OVP Input Current	MAX17129 only; $V_{OVP} = 40V$, $T_A = +25^{\circ}C$, $V_{FB} = 0.75V$			50	μA
	MAX17149 only; $V_{OVP} = 20V$, $T_A = +25^{\circ}C$, $V_{FB} = 0.75V$			25	
FSEL Bias Current	$0.3V < V_{FSEL} < 3.5V$			6	μA
	$4.1V < V_{FSEL} < 26V$			2000	
LED CURRENT SOURCE					
ISET Resistance Range		44		250	k Ω
Full-Scale FB_ Output Current	$R_{ISET} = 44.44k\Omega$	43.3		47.7	mA
	$R_{ISET} = 66.66k\Omega$	29.1		30.9	
	$R_{ISET} = 100k\Omega$	19.4		20.6	
	$R_{ISET} = 133.33k\Omega$	14.55		15.45	
	$R_{ISET} = 200k\Omega$	9.65		10.35	
	$R_{ISET} = 100k\Omega$, hybrid dimming mode	4.4		5.6	
	$R_{ISET} = 250k\Omega$, hybrid dimming mode	1.4		2.6	
ISET Output Voltage		1.225		1.275	V

Electrical Characteristics (continued)(Circuit of Figure 1. $V_{IN} = 12V$, $R_{ISET} = 100k\Omega$, $T_A = -40^\circ C$ to $+85^\circ C$, unless otherwise noted.) (Note 1)

PARAMETER	CONDITIONS	MIN	TYP	MAX	UNITS
Current Regulation Between Strings	$I_{FB_} = 30mA$	-1.5		+1.5	%
	$I_{FB_} = 20mA$	-2.0		+2.0	
	$I_{FB_} = 15mA$	-2.0		+2.0	
	$I_{FB_} = 10mA$	-2.75		+2.75	
	$I_{FB_} = 5mA$, hybrid dimming mode	-6.0		+6.0	
	$I_{FB_} = 2mA$, hybrid dimming mode	-15.0		+15.0	
Minimum FB_ Regulation Voltage	$R_{ISET} = 66.66k\Omega$, 100% duty cycle			550	mV
	$R_{ISET} = 100k\Omega$, 100% duty cycle			365	
	$R_{ISET} = 133.33k\Omega$, 100% duty cycle			275	
	$R_{ISET} = 200k\Omega$, 100% duty cycle			200	
FB_ On-Resistance	$V_{FB_} = 50mV$			20	Ω
FB_ Leakage Current	$V_{FB_} = 28V$, $T_A = +25^\circ C$, EN = GND, $V_{OVP} = 28V$			1	μA
	$V_{FB_} = 40V$, $T_A = +25^\circ C$, EN = GND, $V_{OVP} = 40V$			5	
FB_ On-Time		300			ns
BRT Input High Level		2.1			V
BRT Input Low Level				0.8	V
BRT Dimming Frequency		0.1		25	kHz
EN Input High Level	MAX17129/MAX17149 enabled, PWM dimming mode	2.1			V
	MAX17129/MAX17149 enabled, hybrid dimming mode	1.4		1.8	
EN Input Low Level				0.8	V
FAULT PROTECTION					
OVP Overvoltage	Rising edge, hysteresis = 1.8V	44.1		46.1	V
FB_ Check LED Source Current		0.60		0.73	mA
FB_ Open LED Threshold				700	mV
FB_ Overvoltage Threshold		6.7		9.7	V
BOOST FREQUENCY SELECTION FSEL					
FSEL Input High Level	Select $f_{SW} = 500kHz$	2.1			V
FSEL Input Low Level	Select $f_{SW} = 1000kHz$			0.8	V

Note 1: All devices are 100% production tested at $T_A = +25^\circ C$. Limits over temperature are guaranteed by design.**Note 2:** Specifications are guaranteed by design, not production tested.

Typical Operating Characteristics

(Circuit of Figure 1. $V_{IN} = 12V$, $T_A = +25^{\circ}C$, unless otherwise noted.)

BOOST CONVERTER EFFICIENCY vs. INPUT VOLTAGE
 ($V_{OUT} = 31.8V/I_{OUT} = 120mA$,
 BRIGHTNESS = 100%)

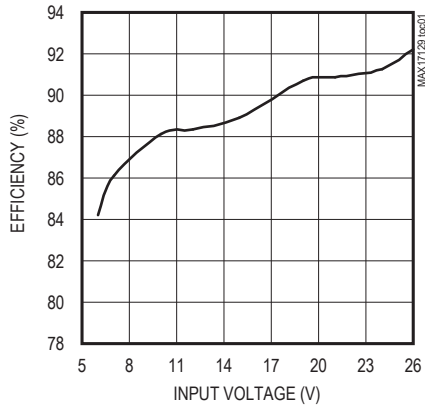

BOOST CONVERTER EFFICIENCY vs. BRIGHTNESS
 ($V_{IN} = 12V$, $V_{OUT} = 31.8V/I_{OUT} = 120mA$
 AT 100%)

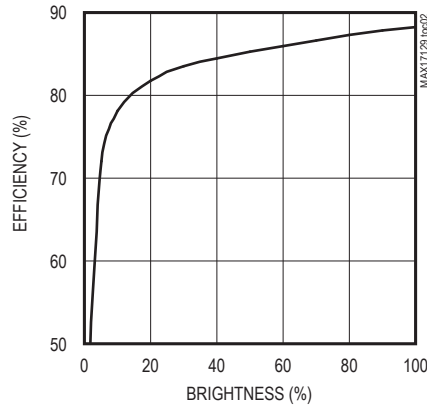

LED CURRENT vs. BRIGHTNESS SETTING

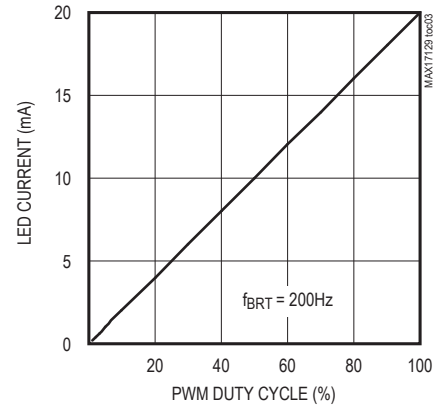

LED CURRENT ($I_{LED} = 20mA$ AT 100% BRIGHTNESS) vs. INPUT VOLTAGE

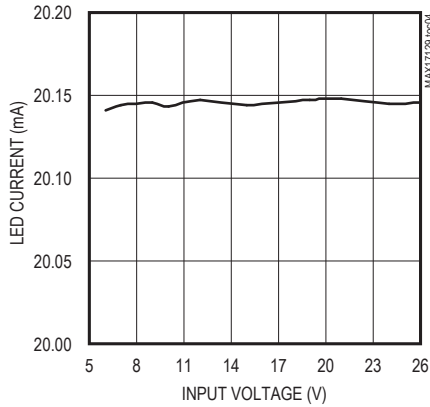

LED CURRENT ($I_{LED} = 20mA$ AT 10% BRIGHTNESS) vs. INPUT VOLTAGE

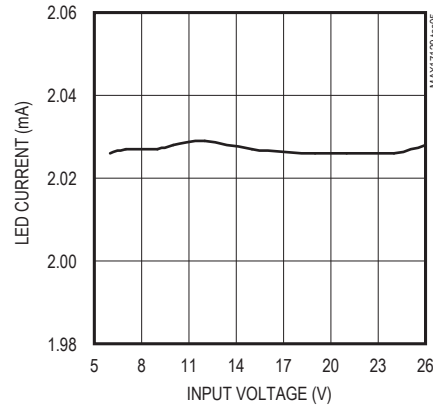

IN QUIESCENT CURRENT vs. IN VOLTAGE

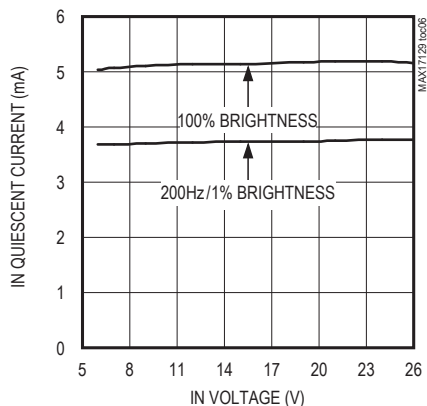

STARTUP WAVEFORMS (BRIGHTNESS = 100%)

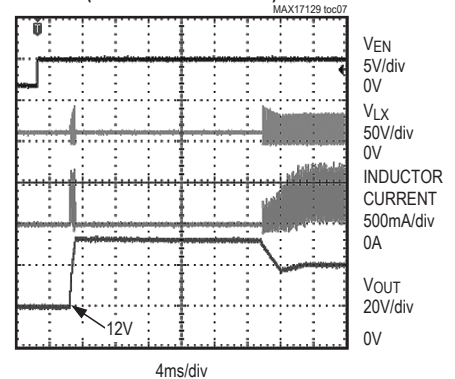

Typical Operating Characteristics (continued)

(Circuit of Figure 1. $V_{IN} = 12V$, $T_A = +25^\circ C$, unless otherwise noted.)

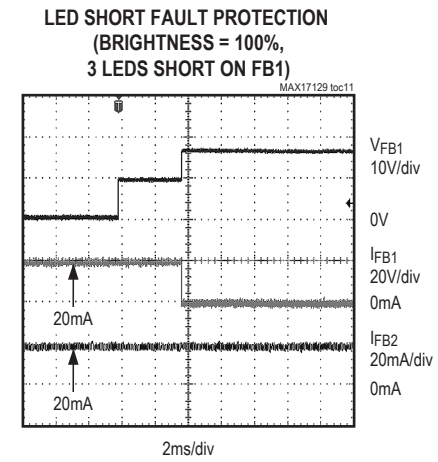
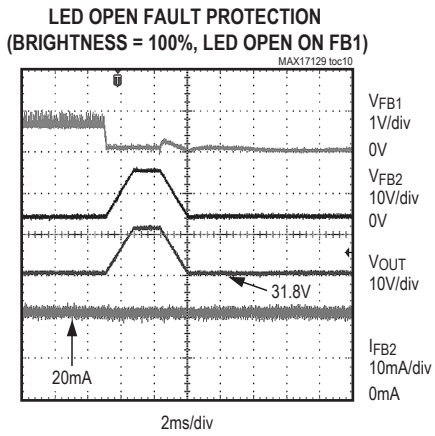
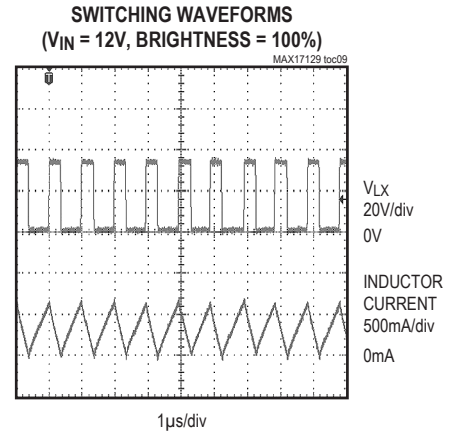
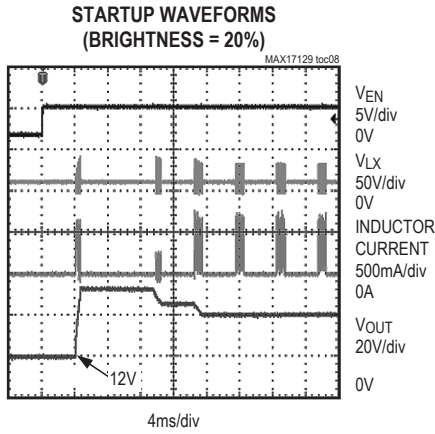

Typical Operating Characteristics (continued)

(Circuit of Figure 1. $V_{IN} = 12V$, $T_A = +25^\circ C$, unless otherwise noted.)

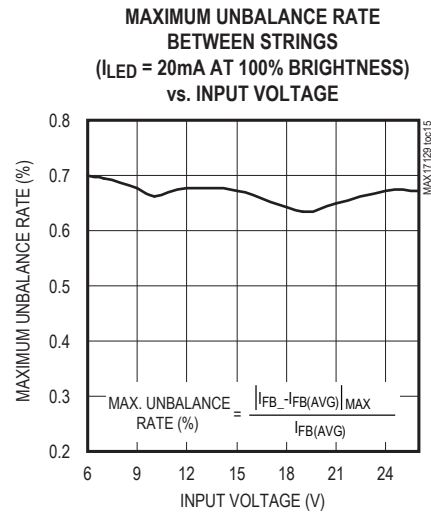
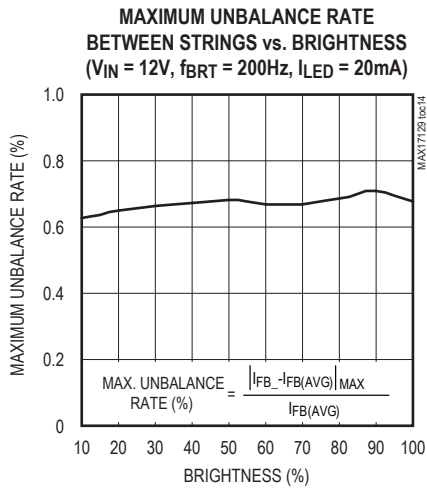
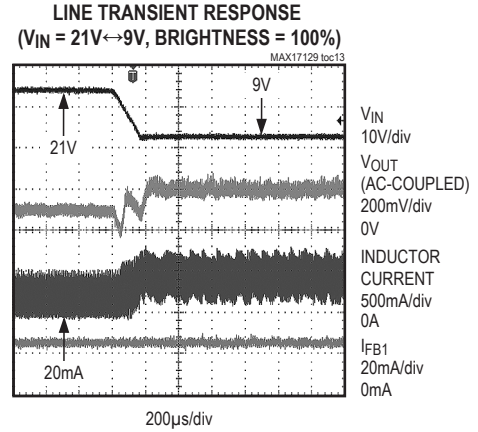
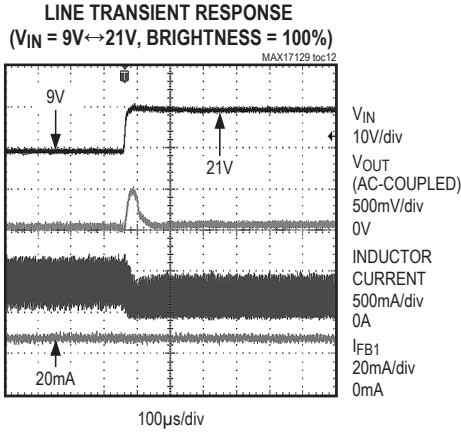

Pin Configuration

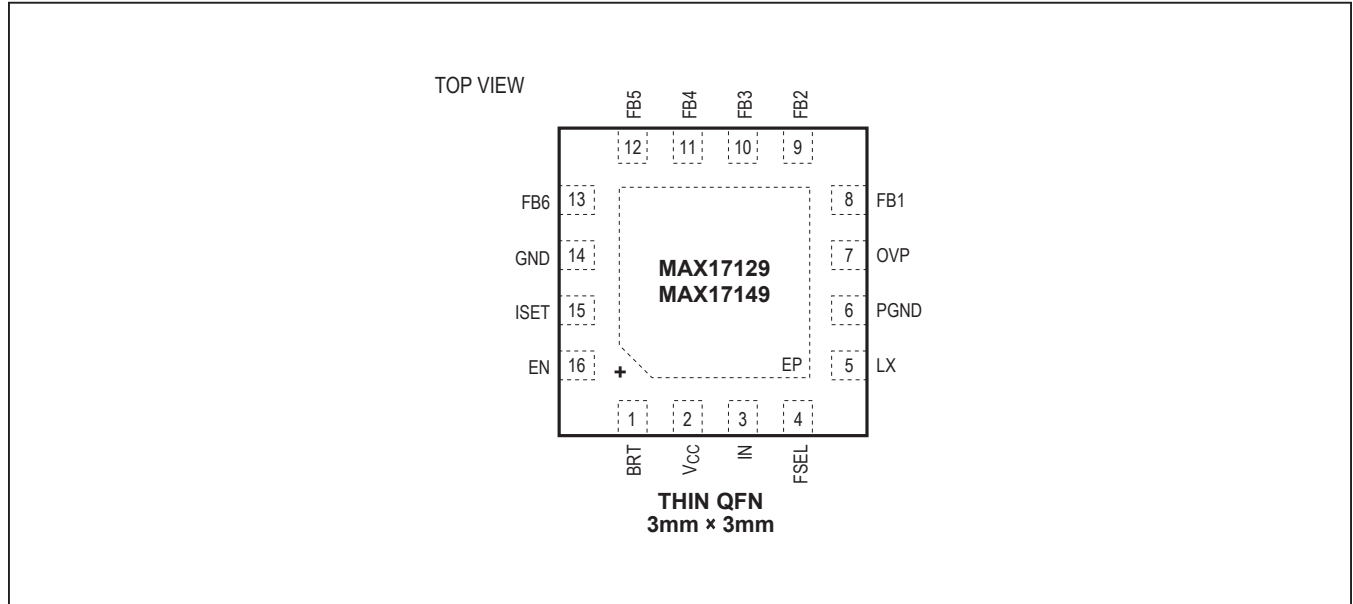

Pin Description

PIN	NAME	FUNCTION
1	BRT	PWM Signal Input. This PWM signal controls the LED brightness by turning the LED current sources on or off.
2	V _{CC}	Internal LDO Output. V _{CC} provides bias supply to the devices. V _{CC} is generated by internal LDO. Connect a minimum 1μF capacitor from V _{CC} to GND. All power outputs are disabled until V _{CC} exceeds its UVLO threshold. See the <i>Input Supply Voltage Configuration and UVLO</i> section for supply configurations for the ICs.
3	IN	Supply Input. Connect IN to the system input supply voltage and bypass IN to GND with a minimum 0.1μF ceramic capacitor. The ICs are disabled if V _{IN} falls below its UVLO threshold. The devices can extend the operating range down to 3.0V if IN and V _{CC} are tied together. See the <i>Input Supply Voltage Configuration and UVLO</i> section.
4	FSEL	Step-Up Converter Switching Frequency Selection Input. Connect to V _{CC} with a 10kΩ resistor to set 500kHz, or connect to GND to set 1MHz.
5	LX	Step-Up Regulator Switching Node. Connect inductor and output diode here and minimize trace area for lowest EMI.
6	PGND	Power Ground
7	OVP	Boost Output Voltage-Sensing Input. This voltage is used for overvoltage protection.
8	FB1	Current-Balancer Output. LED string cathode connection. FB1 is the open-drain output of an internal regulator, which controls current through FB1. FB1 can sink up to 45mA. If unused, connect FB1 to GND or leave high impedance.
9	FB2	Current-Balancer Output. LED string cathode connection. FB2 is the open-drain output of an internal regulator, which controls current through FB2. FB2 can sink up to 45mA. If unused, connect FB2 to GND or leave high impedance.

Pin Description (continued)

PIN	NAME	FUNCTION
10	FB3	Current-Balancer Output. LED string cathode connection. FB3 is the open-drain output of an internal regulator, which controls current through FB3. FB3 can sink up to 45mA. If unused, connect FB3 to GND or leave high impedance.
11	FB4	Current-Balancer Output. LED string cathode connection. FB4 is the open-drain output of an internal regulator, which controls current through FB4. FB4 can sink up to 45mA. If unused, connect FB4 to GND or leave high impedance.
12	FB5	Current-Balancer Output. LED string cathode connection. FB5 is the open-drain output of an internal regulator, which controls current through FB5. FB5 can sink up to 45mA. If unused, connect FB5 to GND or leave high impedance.
13	FB6	Current-Balancer Output. LED string cathode connection. FB6 is the open-drain output of an internal regulator, which controls current through FB6. FB6 can sink up to 45mA. If unused, connect FB6 to GND or leave high impedance.
14	GND	Analog Ground. Connect to ISET resistor ground as close as possible.
15	ISET	Full-Scale LED Current-Adjustment Pin. The resistance from ISET to GND controls the full-scale current in each LED string: $I_{LED_FS} = 20mA \times 100k\Omega / R_{ISET}$ The acceptable resistance range is $44.44k\Omega < R_{ISET} < 200k\Omega$, which corresponds to full-scale LED current of $45mA > I_{LED_FS} > 10mA$.
16	EN	Enable and Dimming Mode Selection Input. Pull EN higher than 2.1V to enable the device, and lower than 0.8V to disable the device. When V_{EN} is higher than 2.1V, direct PWM mode is selected; when V_{EN} is between 1.4V and 1.8V, hybrid dimming mode is selected. While selecting hybrid dimming mode, the device first needs to be enabled.
—	EP	Exposed Backside Pad. Solder to the circuit board ground plane with sufficient copper connection to ensure low thermal resistance. See the <i>PCB Layout Guidelines</i> section.

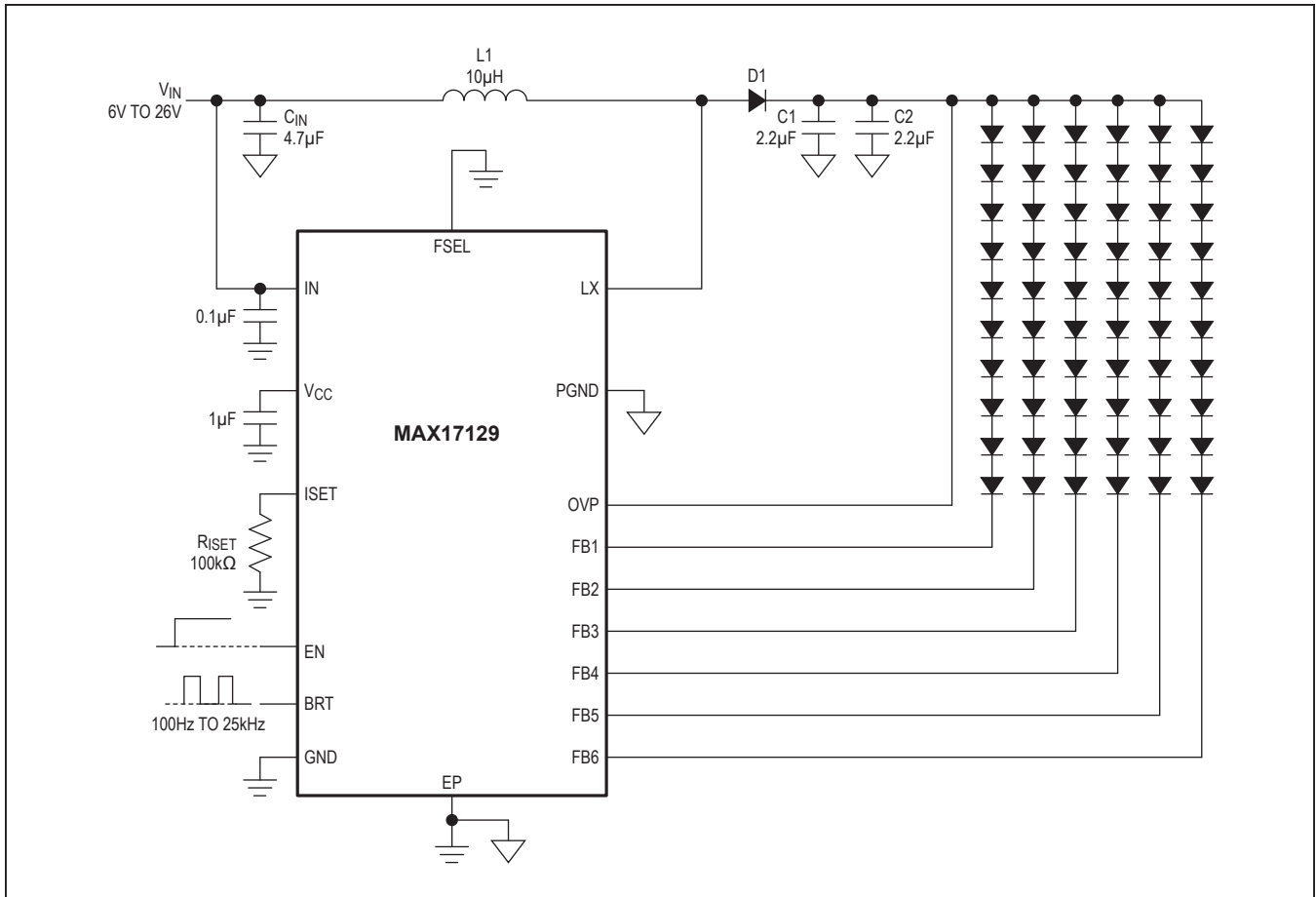

Figure 1. MAX17129 Typical Operating Circuit

Table 1. Component List

DESIGNATION	DESCRIPTION
C _{IN}	4.7µF ±10%, 25V X5R ceramic capacitor (1206) Murata GRM319R61E475KA12D
C1, C2	2.2µF ±20%, 50V X7R ceramic capacitors (1206) Murata GRM31CR71H225K
D1	2A, 40V Schottky diode (M-flat) Toshiba CMS11
L1	10µH, 1.5A, H = 1.2mm VLP6812T-100M1R5
White LED	3.2V (typ), 3.5V (max) at 20mA Nichia NSSW008C

Typical Operating Circuit

The MAX17129 typical operating circuit is shown in Figure 1. Table 1 lists some recommended components, and Table 2 lists the contact information for component suppliers.

Table 2. Component Suppliers

SUPPLIER	PHONE	WEBSITE
Murata Electronics North America, Inc.	770-436-1300	www.murata.com
Nichia Corp.	248-352-6575	www.nichia.com
Sumida Corp.	847-545-6700	www.sumida.com
Toshiba America Electronic Components, Inc.	949-623-2900	www.toshiba.com/taec
Vishay	402-563-6866	www.vishay.com

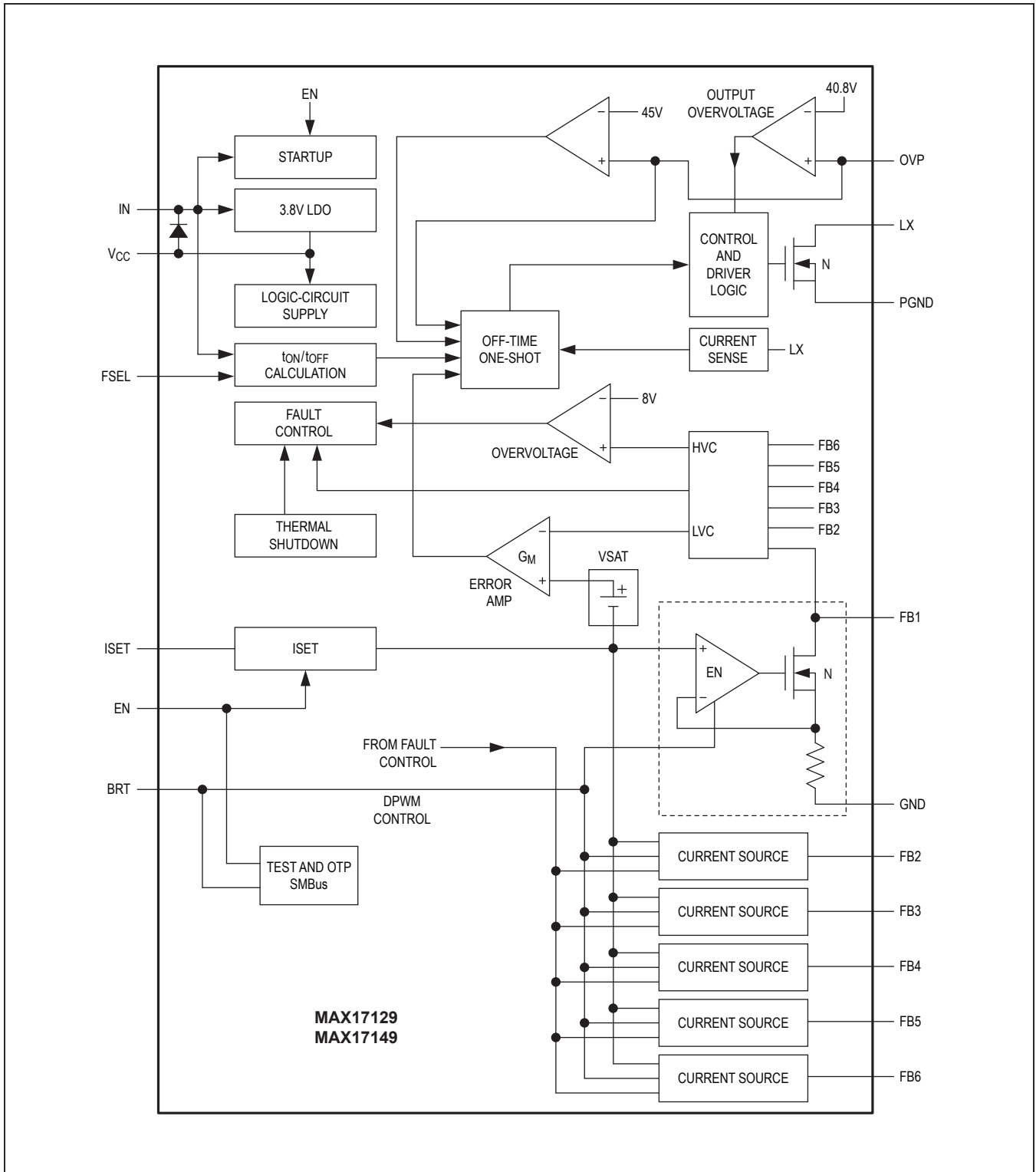

Figure 2. Functional Diagram

Detailed Description

The MAX17129/MAX17149 are high-efficiency drivers for arrays of white LEDs. They contain a Quick-PWM step-up controller, a 3.8V linear regulator, PWM dimming control circuit, internal power MOSFET, and six regulated current sources. Figure 2 shows the devices' functional diagram.

When enabled, the step-up controller boosts the output voltage to provide sufficient headroom for the current sources to regulate their respective string currents. The devices feature adjustable pseudo-fixed frequency, which allows trade-offs between external component size and operating efficiency.

Both devices have a wide input voltage range, from 6V to 26V; when IN and V_{CC} are tied together, the range is extended to the 3V to 5.5V range.

Both devices can implement two different brightness-control methods: PWM dimming and hybrid dimming. When in direct PWM mode, the LED brightness is controlled by the frequency and duty cycle of the square-wave signal applied on the BRT pin. When in hybrid dimming mode, the amplitude of LED current is adjusted to 25% of the full-scale value, which is set by the resistor from the ISET pin to GND.

The devices have multiple features to protect the controller from faulty conditions. A separate feedback loop limits the output voltage in all circumstances. The devices monitor each FB_n voltage during the operation. If one or more strings are open, the corresponding FB_n voltages are pulled below 700mV (max) and the OVP output is forced to increase over the overvoltage threshold; once the open fault is detected, the respective current sources are also disabled. When one or more LEDs are shorted and the related FB_n voltage exceeds 8V, short fault is detected and the respective current source is disabled. When in LED open or short conditions, only the faulty string is disabled while other strings can still operate normally.

The devices also feature other kinds of fault protections, which are overcurrent, output overvoltage, and thermal shutdown. The cycle-by-cycle current limit is to provide consistent operation and soft-start protection; when in overcurrent condition, the devices latch off after a 0.8ms typical (at full brightness) overcurrent-fault timer expires. An output overvoltage protection prevents the devices from switching when the output exceeds a threshold voltage; a thermal-shutdown circuit prevents the devices from excessive power dissipation.

Quick-PWM Step-Up Controller

The step-up converter is a Quick-PWM type for good performance. The Quick-PWM control architecture is a pseudo-fixed-frequency, constant-off-time, current-mode regulator. The control algorithm is simple: the internal switch off-time is determined solely by a one-shot whose period is inversely proportional to output voltage, and directly proportional to input voltage. Figure 4 shows the functional diagram with Quick-PWM control architecture. The off-time one-shot triggers when the error comparator goes low, the inductor current is below the current-limit threshold, and the minimum on-time one-shot times out.

Once the step-up starts up, the output voltage is regulated by selecting the minimum FB voltage between the detected active current-balancer outputs and comparing it to the OVP divider. The soft-start mechanism is inserted to provide a controlled current profile during step-up startup phases.

Off-Time One-Shot

The Quick-PWM core contains a fast, low-jitter, adjustable one-shot that sets the internal MOSFETs off-time. The one-shot varies the off-time in response to the input and feedback voltages. The internal switch off-time is inversely proportional to the output voltage (V_{OVP}), and proportional to the input voltage (V_{IN}):

$$t_{\text{OFF}} = \frac{V_{\text{IN}}}{V_{\text{OVP}} \times K}$$

where the switching period (K) is set by the FSEL pin.

This algorithm results in a nearly constant switching frequency and balanced inductor currents despite the lack of a fixed-frequency clock generator. The benefits of a near-constant switching frequency are two-fold: first, the frequency can be selected to avoid noise-sensitive regions; second, the inductor ripple-current operating point remains relatively constant, resulting in easy design methodology and predictable output-voltage ripple. The off-time one-shots have good accuracy at the operating points specified in the *Electrical Characteristics* table. Off-times translate only roughly to switching frequencies.

The off-times guaranteed in the *Electrical Characteristics* table are influenced by internal switching delays. Resistive losses, including the inductor, internal MOSFET, the forward voltage of the output diode, output capacitor ESR, and PCB copper losses in the output and ground tend to raise the switching frequency at higher output currents.

The actual switching frequency can be approximated by:

$$f_s = \frac{1}{T_{OFF}} \times \frac{V_{IN} - I_{IN} \times R_{DSON}}{V_{OVP} + V_D - I_{IN} \times R_{DSON}}$$

where:

V_D is the forward voltage of the output diode.

R_{DSON} is the on-resistance of the internal MOSFET.

The switching frequency is adjustable by changing the off-time at each supply turn-on cycle. As mentioned above, it is implemented by changing the voltage level of the FSEL pin.

High-frequency operation optimizes the regulator for the smallest component size at the expense of efficiency due

to increased switching losses. Low-frequency operation offers the best overall efficiency but requires larger components and PCB area.

Input Supply Voltage Configuration and UVLO

The devices include an internal low-dropout linear regulator (V_{CC}) and are disabled until V_{CC} exceeds the UVLO threshold. The hysteresis on UVLO is approximately 100mV. When V_{IN} is higher than 6V with EN high, this linear regulator generates a 3.8V supply to power the internal PWM controller, control logic, and MOSFET driver. The V_{CC} voltage drops to 0V with EN low. When the V_{CC} and IN pins are connected together, the devices can operate in a low input-voltage range from 3V to 5.5V.

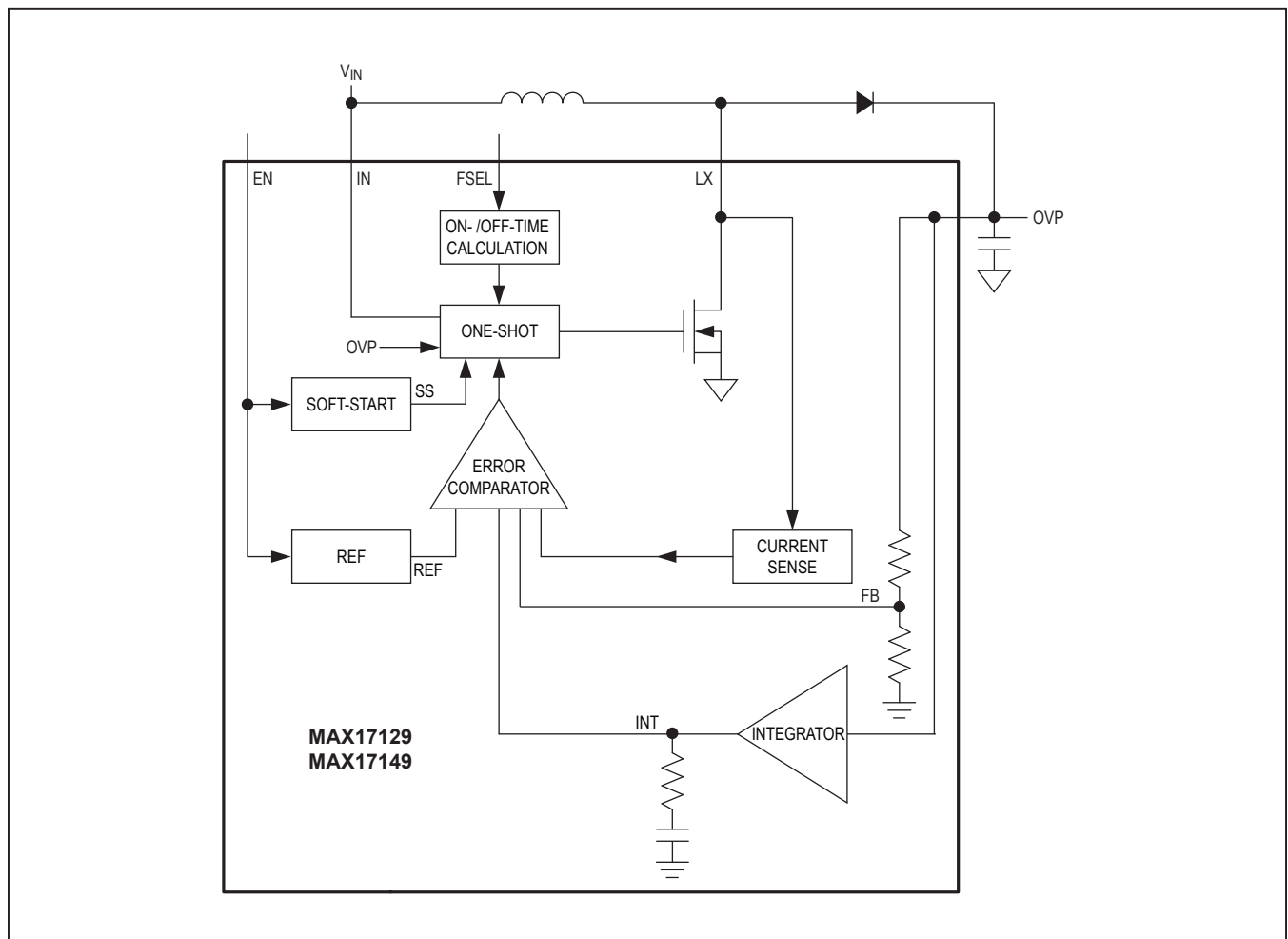

Figure 4. MAX17129/MAX17149 Quick-PWM Control Functional Diagram

Figure 5 shows possible supply connection configurations for the devices. The V_{CC} pin should be bypassed to GND with a minimum $1\mu\text{F}$ ceramic capacitor.

Startup

At startup, the devices perform an LED check by pulling up each FB_- pin with a current source to determine whether a string of LEDs are connected. If an FB_- pin is not connected with LEDs, it is disabled. The process takes approximately 1ms; then the current sources are turned on.

Shutdown

The devices can be placed into shutdown by pulling the EN pin low; when in shutdown mode, the current consumption is $5\mu\text{A}$ max. In the devices, the V_{CC} voltage drops to 0V with EN low.

Overvoltage Protection

To protect the step-up regulator when the load is open, or the output voltage becomes excessive for any reason, the devices feature a dedicated overvoltage-feedback input by monitoring the output (OVP). There are two thresholds for OVP and they provide careful protections. When the OVP voltage exceeds the 43V (typ) for the MAX17129 or 25.4V for the MAX17149, an overvoltage flag is set to enable the open-string detection. When the OVP voltage exceeds 45.2V (typ), the internal power MOSFET stops switching. This step-up regulator switch is reenabled after the V_{OVP} drops 1.8V (typ hysteresis) below the protection threshold. This overvoltage-protection feature ensures the step-up regulator fail-safe operation when the LED strings are disconnected from the output. Considering overvoltage threshold and minimum output-regulation voltage, the MAX17149 is suitable for 3–6 LEDs per string and the MAX17129 is suitable for 6–11 LEDs per string.

Overcurrent Protection

When in overcurrent condition, the devices latch off after a fault timer expires. If running at full brightness, the timeout is approximately 0.8ms (typ). If dimming, this timeout is dependent on the dimming frequency and duty cycle: the sum of the on-time cycles, during which the device is in overcurrent condition, must be 0.8ms (typ) for the timeout to expire.

LED Current Sources

Maintaining uniform LED brightness and dimming capability is critical for backlight applications. The ICs are equipped with a bank of six matched current sources. These specialized current sources are accurate within $\pm 3\%$ and match with each other within 2%. The LED full-scale current is set through the ISET pin ($10\text{mA} < I_{LED_FS} < 45\text{mA}$).

The minimum voltage drop across each current source is 275mV (typ) when the LED current is 20mA. The low-voltage drop helps reduce dissipation, while maintaining sufficient compliance to control the LED current within the required tolerances.

The LED current sources can be disabled by connecting the respective FB_- pin to GND before startup. When the devices are enabled, the controller scans settings for all FB_- pins. If an FB_- pin is not connected to GND, an internal circuit pulls this pin high, and the controller enables the corresponding current source to regulate the string current. If the FB_- pin is connected to GND, the controller disables the corresponding current regulator. The current regulator cannot be disabled by connecting the respective FB_- pin to GND after the IC is enabled.

All FB_- pins in use are combined to extract a lowest FB_- voltage (LVC) (see Figure 2). LVC is fed into the step-up regulator’s error amplifier and is used to set the output voltage.

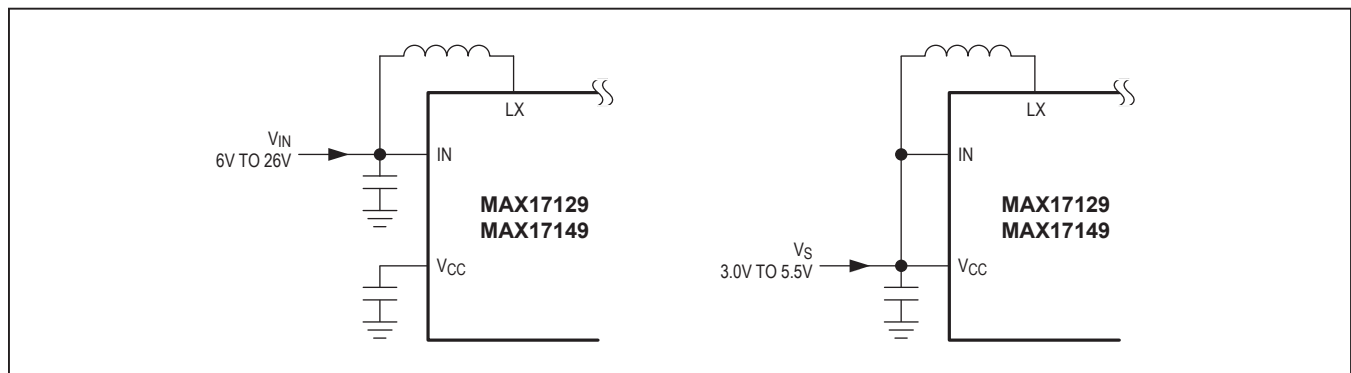

Figure 5. Supply Configurations for the MAX17129/MAX17149

Current-Source Fault Protection

An LED fault open/short is detected after the startup. When one or more strings fail after the startup, the corresponding current source is disabled. The remaining LED strings still operate normally.

LED Short and String Mismatch Protection

The devices can tolerate a slight mismatch between LED strings. When severe mismatches or WLED shorts occur, the FB_ voltages are uneven because of mismatched voltage drop across strings. When FB_ voltage is higher than 8V (typ) after LED turn-on, an LED short is detected. The remaining LED strings can still operate normally.

Open Current-Source Protection

The devices' step-up regulator output voltage is regulated according to the minimum FB_ voltages on all the strings in use. If one or more strings are open, the respective FB_ pins are pulled to ground. For any FB_ lower than 700mV (max), the corresponding current source is disabled. The remaining LED strings can still operate normally. If all strings in use are open, the devices shut the step-up regulator down.

PWM Dimming Control

The devices perform brightness control with the BRT input signal. The current in the LEDs follows the duty cycle and frequency of the BRT signal. The dimming frequency can be from 0.1kHz to 25kHz.

Full-Scale LED Current

The full-scale LED current (I_{LED_FS}) is set by the resistor connected from ISET to GND and:

$$I_{LED_FS} = \frac{20mA \times 100k\Omega}{R_{ISET}}$$

The acceptable resistance range for ISET is $44.44k\Omega < R_{ISET} < 200k\Omega$, which corresponds to a full-scale LED current of $45mA > I_{LED_FS} > 10mA$.

Hybrid Dimming Mode

The devices can implement hybrid dimming by controlling the voltage on the EN pin (between 1.4V and 1.8V) after the device is enabled. In hybrid dimming mode, the LED current is 25% of the full-scale current set by the resistor on the ISET pin. The purpose of this hybrid dimming operation is to improve system efficiency by reducing the current in the LEDs, therefore reducing the forward drop in them.

Thermal Shutdown

The devices include a thermal-protection circuit. When the junction temperature exceeds $T_J = +160^\circ C$

(typ), a thermal sensor immediately activates the fault protection, which shuts down the step-up regulator and all current sources, allowing the devices to cool down. Once the devices cool down by approximately $15^\circ C$, the ICs start up automatically. The thermal-overload protection protects the devices in the event of fault conditions. For continuous operation, do not exceed the absolute maximum junction temperature rating of $T_J = +150^\circ C$.

Design Procedure

All the devices' designs should be prototyped and tested prior to production.

External component value choice is primarily dictated by the output voltage and the maximum load current, as well as maximum and minimum input voltages. Begin by selecting an inductor value. Once the inductor is known, choose the diode and capacitors.

Inductor Selection

The inductance, peak current rating, series resistance, and physical size should all be considered when selecting an inductor. These factors affect the converter's operating mode, efficiency, maximum output-load capability, transient response time, output-voltage ripple, and cost.

The maximum output current, input voltage, output voltage, and switching frequency determine the inductor value. Very high inductance minimizes the current ripple, and therefore reduces the peak current, which decreases core losses in the inductor and I^2R losses in the entire power path. However, large inductor values also require more energy storage and more turns of wire, which increase physical size and I^2R copper losses. Low inductor values decrease the physical size but increase the current ripple and peak current. Finding the best inductor involves compromises among circuit efficiency, inductor size, and cost.

In choosing an inductor, the first step is to determine the operating mode: continuous-conduction mode (CCM) or discontinuous-conduction mode (DCM). When CCM is chosen, the ripple current and peak current of the inductor can be minimized. If a small-size inductor is required, DCM can be chosen. In DCM, the inductor value and size can be minimized but the inductor ripple current and peak current are higher than those in CCM. The controller can be stable, but there is a maximum inductor value requirement to ensure the DCM operating mode. The equations used here include a constant LIR, which is the ratio of the inductor peak-to-peak ripple current to the average DC inductor current at the full-load current. The controller operates in DCM when LIR is higher than 2.0,

and it works in CCM when LIR is lower than 2.0. The best trade-off between inductor size and converter efficiency for step-up regulators generally has an LIR between 0.3 and 0.5; however, depending on the AC characteristics of the inductor core material and ratio of inductor resistance to other power-path resistances, the best LIR can shift up or down. If the inductor resistance is relatively high, more ripples can be accepted to reduce the number of required turns and increase the wire diameter. If the inductor resistance is relatively low, increasing inductance to lower the peak current can reduce losses throughout the power path. If extremely thin high-resistance inductors are used, as is common for LCD panel applications, an LIR higher than 2.0 can be chosen for DCM operating mode.

Once a physical inductor is chosen, higher and lower values of the inductor should be evaluated for efficiency improvements in typical operating regions. The detailed design procedure for CCM can be described as:

Calculate the approximate inductor value using the typical input voltage (V_{IN}), the maximum output current ($I_{OUT(MAX)}$), the expected efficiency (η_{TYP}) taken from an appropriate curve in the *Typical Operating Characteristics*, and an estimate of LIR based on the above discussion:

$$I_{IN(DC,MAX)} = \frac{I_{OUT(MAX)} \times V_{OUT}}{V_{IN(MIN)} \times \eta_{MIN}}$$

Choose an available inductor value from an appropriate inductor family. Calculate the maximum DC input current at the minimum input voltage $V_{IN(MIN)}$, using conservation of energy and the expected efficiency at that operating point (η_{MIN}) taken from an appropriate curve in the *Typical Operating Characteristics*:

Calculate the ripple current at that operating point and the peak current required for the inductor:

$$I_{RIPPLE} = \frac{V_{IN(MIN)} \times (V_{OUT(MAX)} - V_{IN(MIN)})}{L_{CCM} \times V_{OUT(MAX)} \times f_{SW}}$$

$$I_{PEAK_CCM} = I_{IN(DC,MAX)} + \frac{I_{RIPPLE}}{2}$$

When DCM operating mode is chosen to minimize the inductor value, the calculations are different from those above in CCM operating mode. The maximum inductor value for DCM (or the minimum inductor value for CCM) is calculated with the following equation:

$$L_{DCM(MAX)} = \left(1 - \frac{V_{IN(MIN)}}{V_{OUT(MAX)}}\right) \times \frac{V_{IN(MIN)}^2 \times \eta}{2 \times f_{SW} \times V_{OUT(MAX)} \times I_{OUT(MAX)}}$$

The peak inductor current in DCM is calculated with the following equation:

$$I_{PEAK_DCM} = \sqrt{\frac{I_{OUT(MAX)} \times 2 \times (V_{OUT(MAX)} - V_{IN(MIN)})}{L_{DCM} \times f_{SW} \times \eta}}$$

The inductor's saturation current rating should exceed I_{PEAK} and the inductor's DC current rating should exceed $I_{IN(DC,MAX)}$. For good efficiency, choose an inductor with less than 0.1Ω series resistance.

Considering the circuit with six 10-LED strings and 20mA LED full-scale current, the maximum load current ($I_{OUT(MAX)}$) is 120mA with a 32V output and a minimal input voltage of 7V.

Choosing a CCM operating mode with LIR = 0.8 at 1MHz and estimating efficiency of 85% at this operating point:

$$L_{CCM} = \left(\frac{7V}{32V}\right)^2 \left(\frac{32V - 7V}{120mA \times 1MHz}\right) \left(\frac{0.85}{0.8}\right) = 10.59\mu H$$

A $10\mu H$ inductor is chosen and the peak inductor current at minimum input voltage is calculated as follows:

$$I_{PEAK_CCM} = \frac{120mA \times 32V}{7V \times 0.85} + \frac{7V \times (32V - 7V)}{2 \times 10\mu H \times 32V \times 1MHz} = 0.92A$$

Alternatively, choose a DCM operating mode by using lower inductance and estimating efficiency of 85% at this operating point. Since DCM has higher peak inductor current at lower input, it causes current limit when the parameters are not chosen properly. Considering the case with six 10-LED strings and 20mA LED full-scale current to prevent excessive switch current from causing current limit:

$$L_{DCM(MAX)} = \left(1 - \frac{7V}{32V}\right) \times \frac{(7V)^2 \times 0.85}{2 \times 1MHz \times 32V \times 120mA} = 4.24\mu H$$

A 3.3μH inductor is chosen. The peak inductor current at minimum input voltage is calculated as follows:

$$I_{PEAK_DCM} = \sqrt{\frac{120\text{mA} \times 2 \times 32\text{V} \times (32\text{V} - 7\text{V})}{3.3\mu\text{H} \times 1\text{MHz} \times 0.85 \times (32\text{V})}} = 1.46\text{A}$$

Output Capacitor Selection

The total output-voltage ripple has two components: the capacitive ripple caused by the charging and discharging on the output capacitor, and the ohmic ripple due to the capacitor's equivalent series resistance (ESR):

$$V_{RIPPLE} = V_{RIPPLE(C)} + V_{RIPPLE(ESR)}$$

$$V_{RIPPLE(C)} \approx \frac{I_{OUT(MAX)}}{C_{OUT}} \left(\frac{V_{OUT(MAX)} - V_{IN(MIN)}}{V_{OUT(MAX)} \times f_{SW}} \right)$$

and:

$$V_{RIPPLE(ESR)} \approx I_{PEAK} \times R_{ESR(COUT)}$$

where I_{PEAK} is the peak inductor current (see the *Inductor Selection* section).

The output-voltage ripple voltage should be low enough for the FB_ current-source regulation. The ripple voltage should be less than 200mV_{P-P}. For ceramic capacitors, the output-voltage ripple is typically dominated by $V_{RIPPLE(C)}$. The voltage rating and temperature characteristics of the output capacitor must also be considered.

Rectifier Diode Selection

The devices' high switching frequency demands a high-speed rectifier. Schottky diodes are recommended for most applications because of their fast recovery time and low forward voltage. The diode should be rated to handle the output voltage and the peak switch current. Make sure that the diode's peak current rating is at least I_{PEAK} calculated in the *Inductor Selection* section and that its breakdown voltage exceeds the output voltage.

Input Capacitor Selection

The input capacitor (C_{IN}) filters the current peaks drawn from the input supply and reduces noise injection into the ICs. A 4.7μF ceramic capacitor is used in the

Typical Operating Circuit (Figure 1) because of the high source impedance seen in typical lab setups. Actual applications usually have much lower source impedance since the step-up regulator often runs directly from the output of another regulated supply. In some applications, C_{IN} can be reduced below the values used in the *Typical Operating Circuit*. Ensure a low-noise supply at IN by using adequate C_{IN} , especially when running at low IN voltage. Alternatively, greater voltage variation can be tolerated on C_{IN} if IN is decoupled from C_{IN} using an RC lowpass filter.

LED Selection and Bias

The series/parallel configuration of the LED load and the full-scale bias current have a significant effect on regulator performance. LED characteristics vary significantly from manufacturer to manufacturer. Consult the respective LED data sheets to determine the range of output voltages for a given brightness and LED current. In general, brightness increases as a function of bias current. This suggests that the number of LEDs could be decreased if higher bias current is chosen; however, a high current increases LED temperature and reduces operating life. Improvements in LED technology are resulting in devices with lower forward voltage while increasing the bias current and light output.

LED manufacturers specify the LED color at a given LED current. With lower LED current, the color of the emitted light tends to shift toward the blue range of the spectrum. A blue bias is often acceptable for business applications but not for high-image-quality applications such as DVD players. DPWM dimming is a viable solution for reducing power dissipation while maintaining LED color integrity. Careful attention should be paid to switching noise to avoid other display quality problems.

Using fewer LEDs in a string improves step-up converter efficiency, and lowers breakdown voltage requirements of the external MOSFET and diode. The minimum number of LEDs in series should always be greater than the maximum input voltage. If the diode voltage drop is lower than the maximum input voltage, the voltage drop across the current-sense inputs (FB_) increases and causes excess heating in the IC. Between 8 and 12 LEDs in series are ideal for input voltages up to 20V.

Applications Information

LED V_{FB} Variation

The forward voltage of each white LED may vary up to 25% from part to part and the accumulated voltage difference in each string equates to additional power loss within the devices. For the best efficiency, the voltage difference between strings should be minimized. The difference between lowest voltage string and highest voltage string should be less than 8V (typ); otherwise, the internal LED short-protection circuit disables the high FB_{-} voltage string.

FB_{-} Pin Maximum Voltage

The current through each FB_{-} pin is controlled only during the step-up converter's on-time. During the converter off-time, the current sources are turned off. The output voltage does not discharge and stays high. The devices disable the FB current source, which the string shorts. In this case, the step-up converter's output voltage is always applied to the disabled FB_{-} pin. The FB_{-} pin can withstand 48V.

PCB Layout Guidelines

Careful PCB layout is important for proper operation. Use the following guidelines for good PCB layout:

- 1) Minimize the area of high current-switching loop of the rectifier diode, internal MOSFET, and output capacitor to avoid excessive switching noise.
- 2) Connect high-current input and output components with short and wide connections. The high-current input loop goes from the positive terminal of the input

capacitor to the inductor, to the internal MOSFET, then to the input capacitor's negative terminal. The high-current output loop is from the positive terminal of the input capacitor to the inductor, to the rectifier diode, to the positive terminal of the output capacitors, reconnecting between the output capacitor and input capacitor ground terminals. Avoid using vias in the high-current paths. If vias are unavoidable, use multiple vias in parallel to reduce resistance and inductance.

- 3) Create a ground island (PGND) consisting of the input and output capacitor ground. Connect all these together with short, wide traces or a small ground plane. Maximizing the width of the power ground traces improves efficiency and reduces output-voltage ripple and noise spikes. Create an analog ground island (GND) consisting of ISET, IN, V_{CC} connections, and the devices' exposed backside pad. Connect the GND and PGND islands by connecting the GND pins directly to the exposed backside pad. Make no other connections between these separate ground planes.
- 4) Place the IN pin and V_{CC} pin bypass capacitors as close as possible to the device. The ground connection of the bypass capacitors should be connected directly to the GND pins with a wide trace.
- 5) Minimize the size of the LX node while keeping it wide and short. If possible, avoid running the LX node from one side of the PCB to the other. Use DC traces as shield if necessary.

Refer to the MAX17129/MAX17149 evaluation kit for an example of proper board layout.

Simplified Operating Circuit

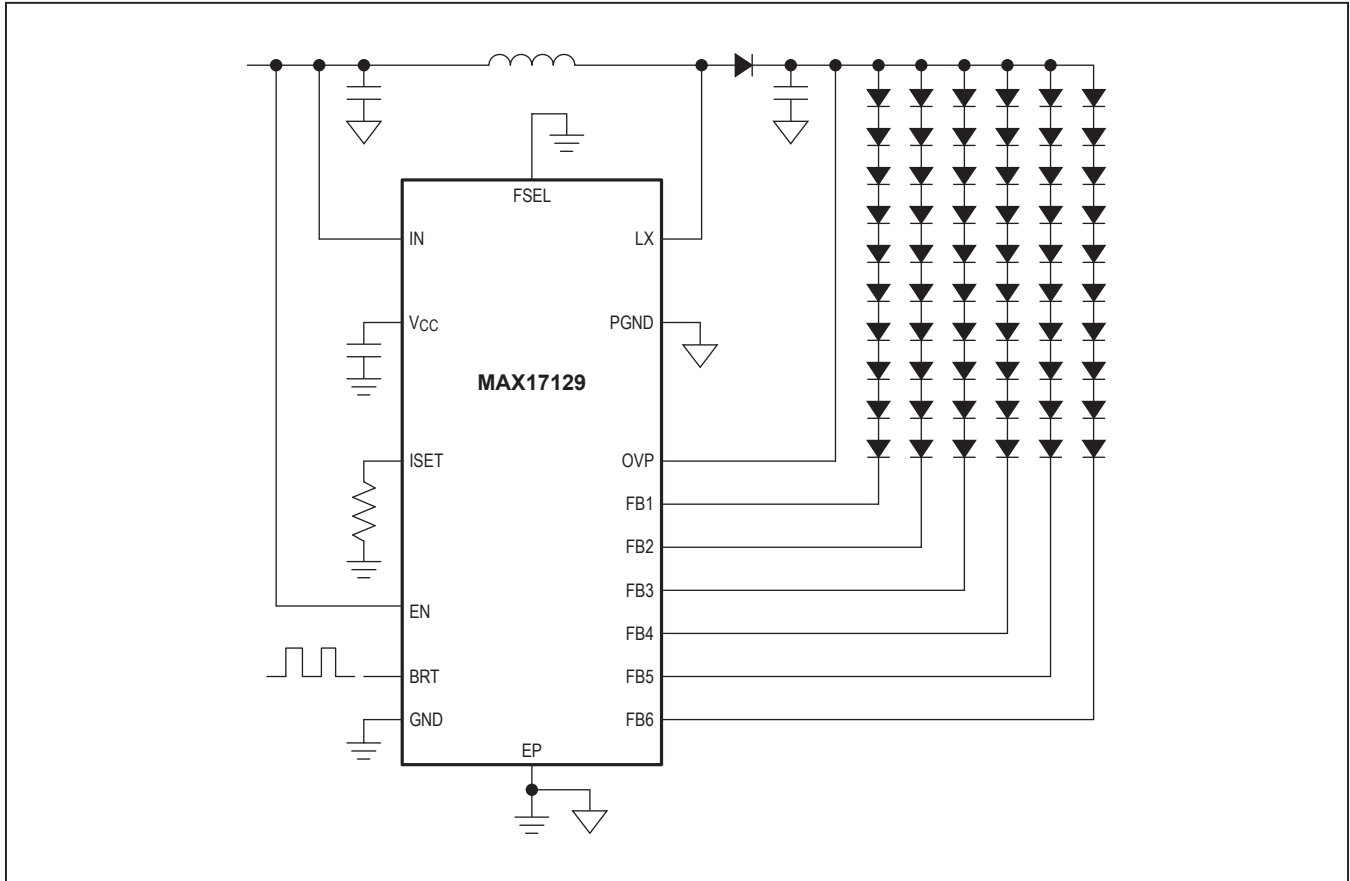

Chip Information

PROCESS: BiCMOS

Package Information

For the latest package outline information and land patterns (footprints), go to www.maximintegrated.com/packages. Note that a "+", "#", or "-" in the package code indicates RoHS status only. Package drawings may show a different suffix character, but the drawing pertains to the package regardless of RoHS status.

PACKAGE TYPE	PACKAGE CODE	OUTLINE NO.	LAND PATTERN NO.
16 TQFN-EP	T1633+5	21-0136	90-0032

Revision History

REVISION NUMBER	REVISION DATE	DESCRIPTION	PAGES CHANGED
0	12/10	Initial release	—
1	9/11	Updated die specifications	1–6, 8, 9, 12–15, 17
2	11/14	No <i>IV</i> OPNs in <i>Ordering Information</i> ; removed automotive reference from <i>Applications</i> section	1

For pricing, delivery, and ordering information, please contact Maxim Direct at 1-888-629-4642, or visit Maxim Integrated's website at www.maximintegrated.com.

Maxim Integrated cannot assume responsibility for use of any circuitry other than circuitry entirely embodied in a Maxim Integrated product. No circuit patent licenses are implied. Maxim Integrated reserves the right to change the circuitry and specifications without notice at any time. The parametric values (min and max limits) shown in the Electrical Characteristics table are guaranteed. Other parametric values quoted in this data sheet are provided for guidance.