

**PLEASE CHECK WWW.MOLEX.COM FOR LATEST PART INFORMATION**

**Part Number:** [5022502791](#)  
**Status:** **Active**  
**Overview:** FFC-FPC (SMT)  
**Description:** 0.30mm Pitch Easy-On BackFlip Type FPC Connector, Right Angle, Surface Mount, Dual Contact Style, 0.90mm Mated Height, 27 Circuits

**Documents:**

[3D Model](#) [Packaging Specification SPK-502250-001-001 \(PDF\)](#)  
[Drawing \(PDF\)](#) [RoHS Certificate of Compliance \(PDF\)](#)  
[Product Specification PS-502250-001-001 \(PDF\)](#)

**General**

Product Family	FFC/FPC Connectors
Series	<a href="#">502250</a>
Comments	Black Actuator
Overview	<a href="#">FFC-FPC (SMT)</a>
Product Name	Easy-On
UPC	800756887845

**Physical**

Circuits (Loaded)	27
Color - Resin	Natural
Contact Position	Dual
Durability (mating cycles max)	10
Entry Angle	90° Angle
Mated Height	0.90mm
Material - Metal	Copper Alloy
Material - Plating Mating	Gold
Material - Plating Termination	Gold
Material - Resin	Liquid Crystal Polymer
Net Weight	66.634/mg
Number of Rows	1
Orientation	Right Angle
PCB Locator	No
PCB Retention	Yes
Packaging Type	Embossed Tape on Reel
Pitch - Mating Interface	0.30mm
Polarized to PCB	Yes
Stackable	No
Temperature Range - Operating	-40°C to +105°C
Termination Interface: Style	Surface Mount
Wire/Cable Type	FPC only

**Electrical**

Current - Maximum per Contact	0.2A
Voltage - Maximum	50V AC (RMS)/DC

**Material Info**

**Reference - Drawing Numbers**

Packaging Specification	SPK-502250-001-001
Product Specification	PS-502250-001-001
Sales Drawing	5022500000-000, 5022501000-000

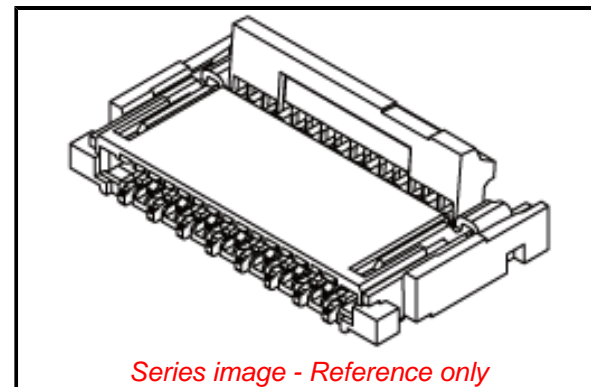

*Series image - Reference only*

**EU ELV**

**Not Relevant**

**EU RoHS**

**Compliant**

**REACH SVHC**

Not Contained Per -  
ED/30/2017 (7 July  
2017)

**Halogen-Free**

**Status**

**Not Low-Halogen**

**Need more information on product environmental compliance?**

Email [productcompliance@molex.com](mailto:productcompliance@molex.com)  
Please visit the [Contact Us](#) section for any non-product compliance questions.

China ROHS	Green Image
ELV	Not Relevant
RoHS Phthalates	Not Contained

**Search Parts in this Series**

[502250 Series](#)