

**PLUG MATED TO R/A RECEPTACLE  
MATED PROFILE**

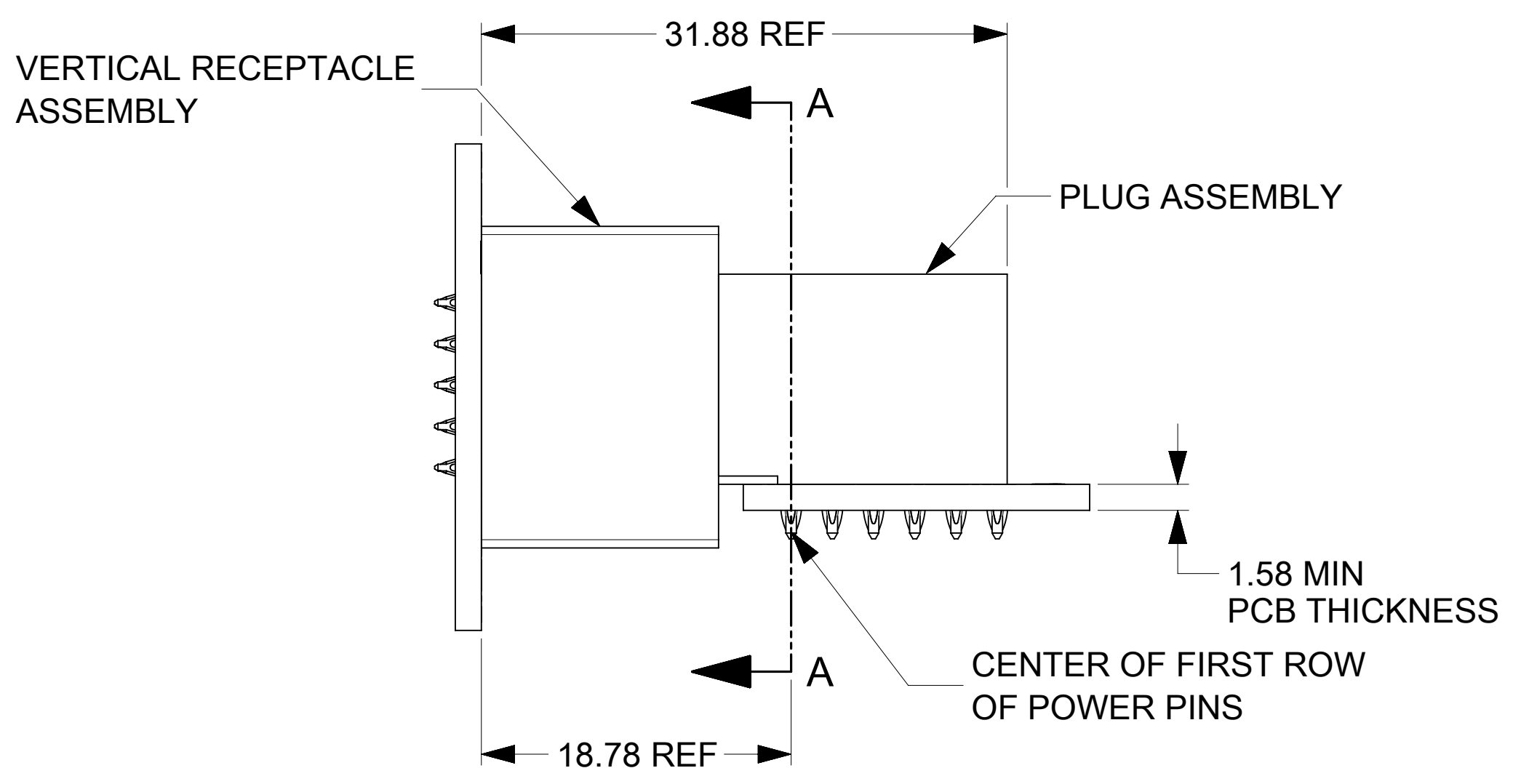

**PLUG MATED TO VERTICAL RECEPTACLE  
MATED PROFILE**

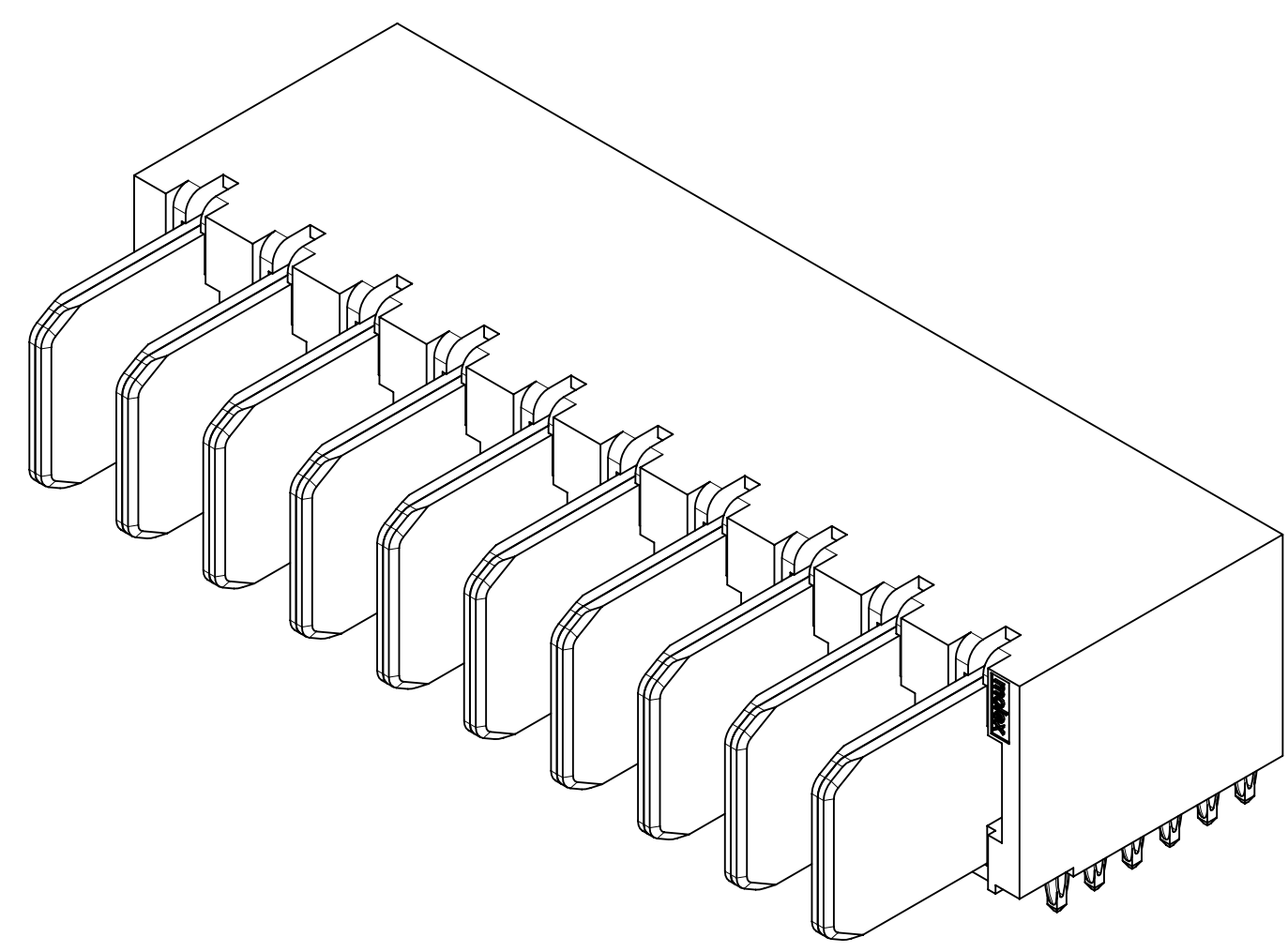
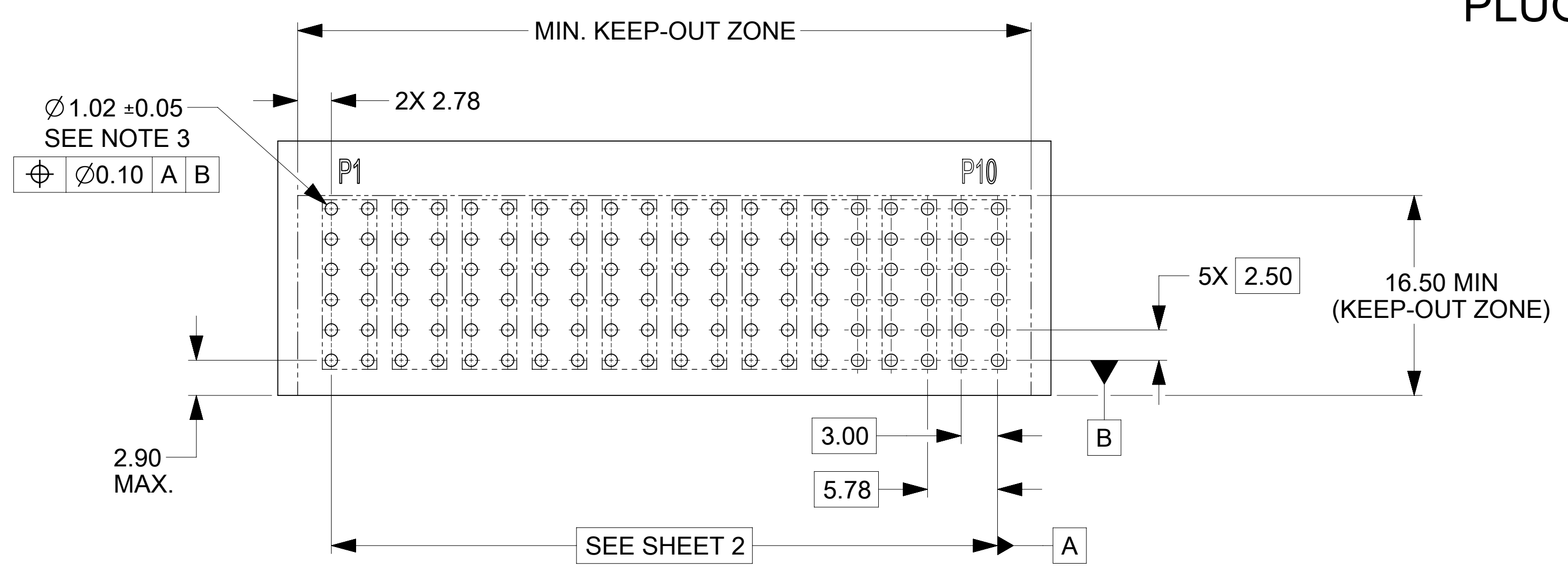
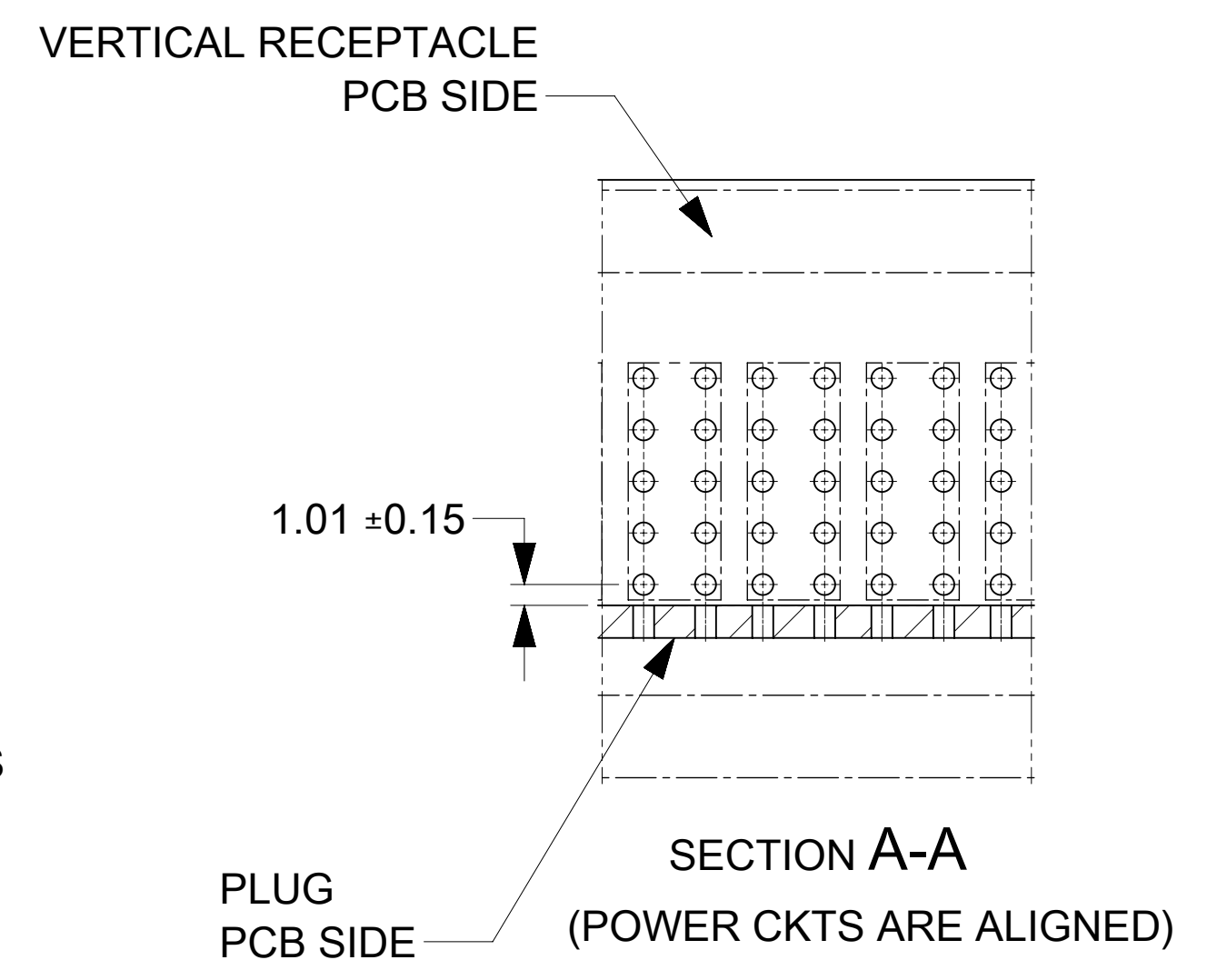

**RECOMMENDED PCB LAYOUT AND KEEP-OUT ZONE**

- NOTES:**
- MATERIAL:**
    - HOUSINGS: LCP UL94, V-0, COLOR : BLACK
    - TERMINALS: HIGH CONDUCTIVITY COPPER ALLOY
    - PLATING: 1.27  $\mu\text{m}$  (50  $\mu\text{in}$ ) NICKEL OVERALL WITH 2.54  $\mu\text{m}$  (100  $\mu\text{in}$ ) SELECTIVE TIN ON TAILS AND 0.762  $\mu\text{m}$  (30  $\mu\text{in}$ ) SELECTIVE GOLD ON CONTACT AREA
  - PACKAGING:** ASSEMBLIES TO BE TRAY PACKED PER PACKAGING SPEC: 2141130010-PK.
  - PLATED THRU HOLE SIZE,** REFER TO PRODUCT SPEC. FOR DETAILS.
  - PRODUCT SPEC:** 2141130000-PS.
  - PRODUCT TO MEET** RoHS REQUIREMENTS.
  - PLUG ASSEMBLY MATES TO MOLEX RECEPTACLES** 219563XXXX-SD AND 219564XXXX-SD, SEE DRAWINGS FOR DETAILS.
  - TAIL DESIGN:** COMPLIANT PIN.
  - POWER TERMINALS ARE LUBRICATED.**
  - APPLICATION SPECIFICATION:** 2141130000-AS (FOR COMPLIANT TAILS ONLY).

THIS DRAWING CONTAINS INFORMATION THAT IS PROPRIETARY TO MOLEX ELECTRONIC TECHNOLOGIES, LLC AND SHOULD NOT BE USED WITHOUT WRITTEN PERMISSION										
DIMENSION UNITS	SCALE	CURRENT REV DESC:								
mm	3:1									
GENERAL TOLERANCES (UNLESS SPECIFIED)										
ANGULAR TOL	± °									
4 PLACES	±									
3 PLACES	±									
2 PLACES	± 0.25									
1 PLACE	± 0.3									
0 PLACES	±									
DRAFT WHERE APPLICABLE MUST REMAIN WITHIN DIMENSIONS		THIRD ANGLE PROJECTION	DRAWING	SERIES	MATERIAL NUMBER	CUSTOMER	SHEET NUMBER			
			D-SIZE	219562	SEE CHART		1 OF 2			
		EC NO: 745288		2023/03/21						
		DRWN: LZABJANOVSKI		2023/04/10						
		CHK'D: JAYK1		2023/04/10						
		APPR: JAYK1		2023/04/10						
		INITIAL REVISION:		2022/03/29						
		DRWN: LZABJANOVSKI		2022/08/04						
		APPR: BPISZCZOR		2022/08/04						
						DOCUMENT NUMBER		DOC TYPE	DOC PART	REVISION
						2195629003-SD		PSD	000	A1

PART NUMBER	CONFIGURATION	QUANTITY PER CARTON (DU)
219562-0031	1P	656

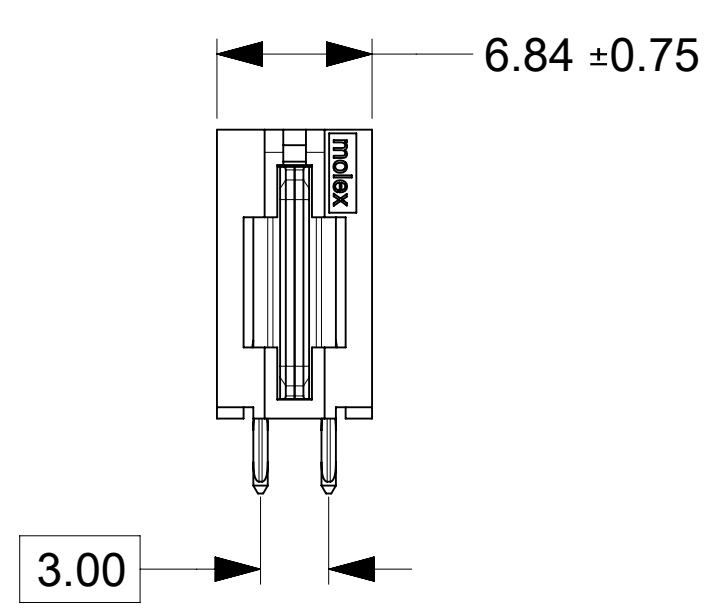

PART NUMBER	CONFIGURATION	QUANTITY PER CARTON (DU)
219562-0032	2P	352

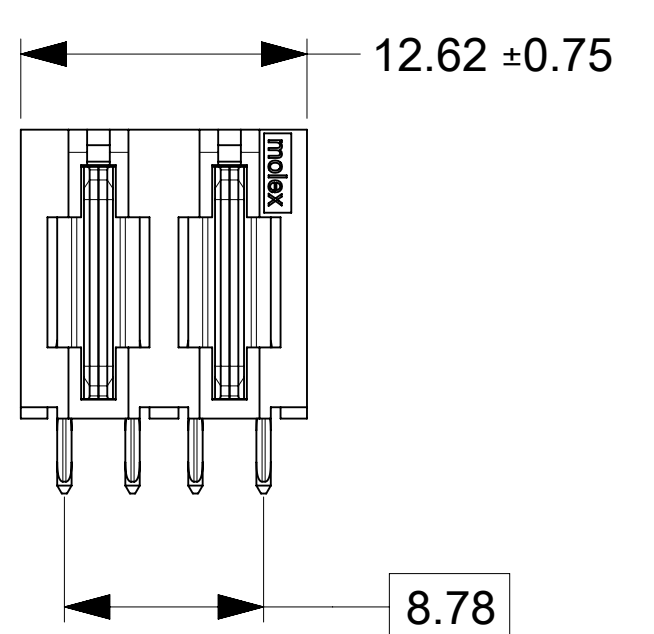

PART NUMBER	CONFIGURATION	QUANTITY PER CARTON (DU)
219562-0033	3P	240

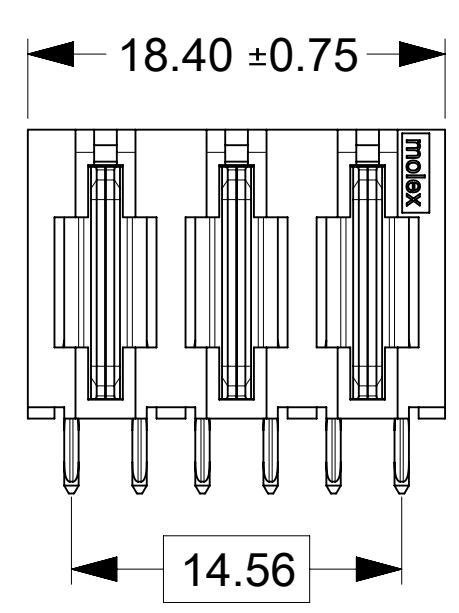

PART NUMBER	CONFIGURATION	QUANTITY PER CARTON (DU)
219562-0034	4P	176

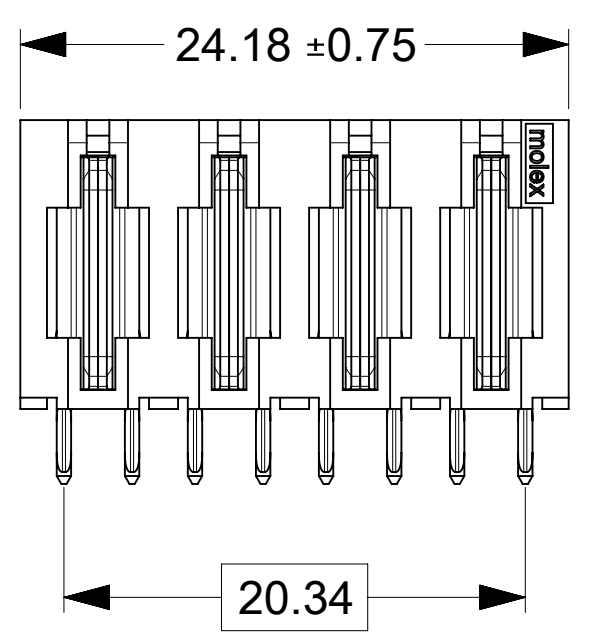

PART NUMBER	CONFIGURATION	QUANTITY PER CARTON (DU)
219562-0035	5P	144

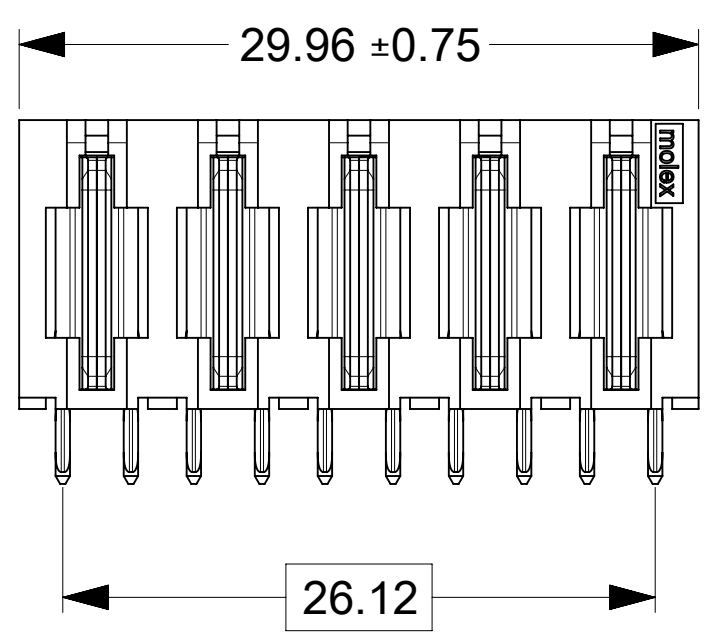

PART NUMBER	CONFIGURATION	QUANTITY PER CARTON (DU)
219562-0036	6P	112

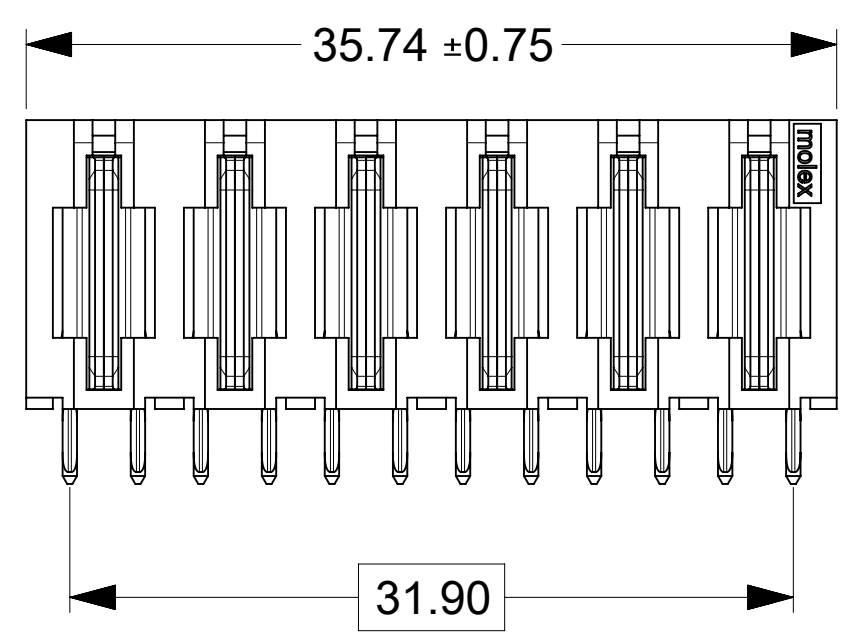

PART NUMBER	CONFIGURATION	QUANTITY PER CARTON (DU)
219562-0037	7P	96

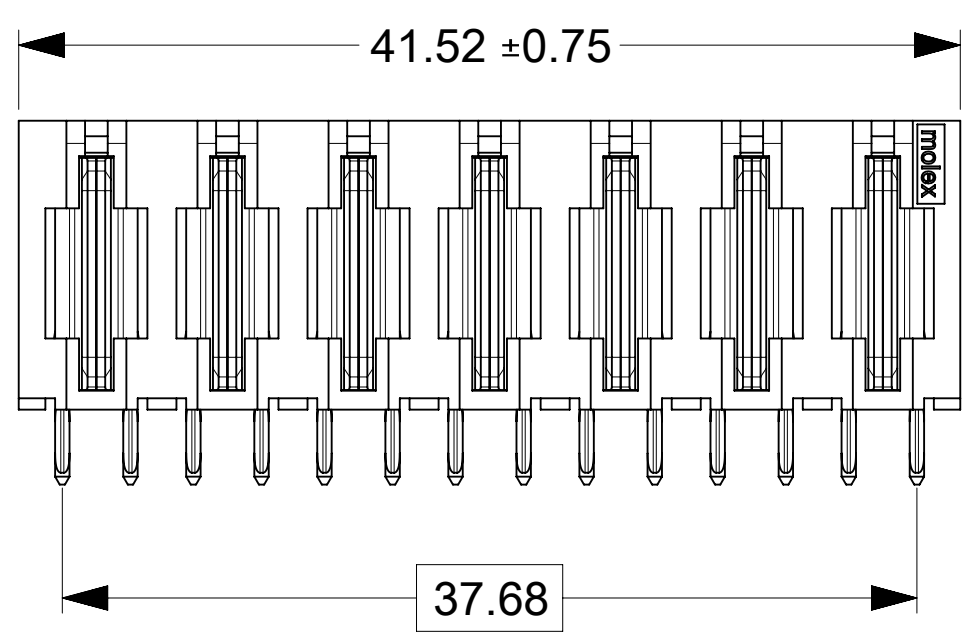

PART NUMBER	CONFIGURATION	QUANTITY PER CARTON (DU)
219562-0038	8P	96

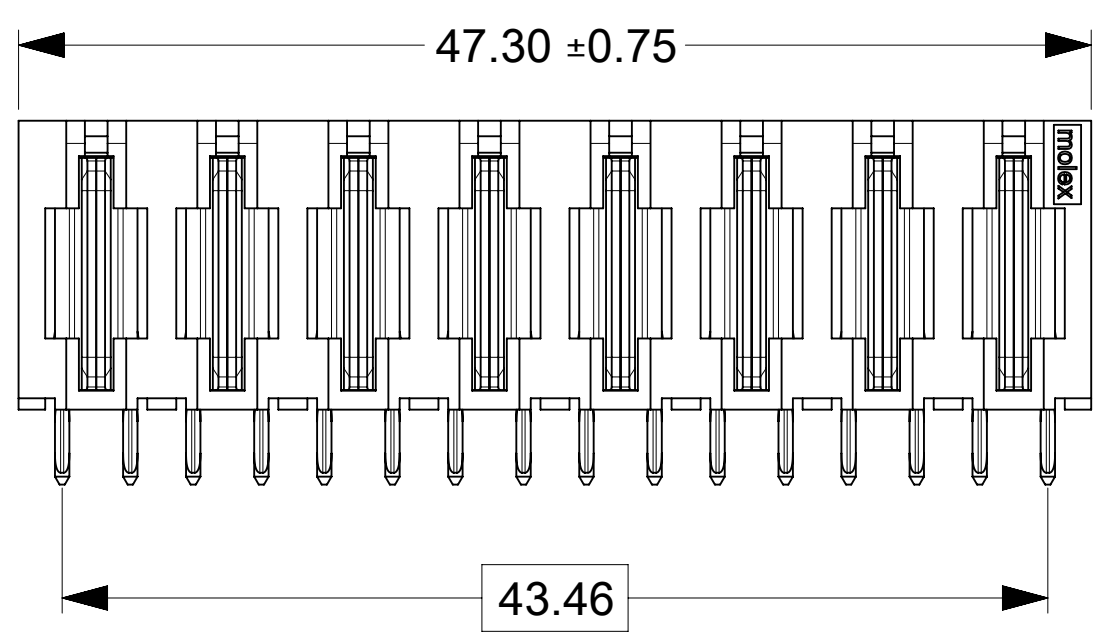

PART NUMBER	CONFIGURATION	QUANTITY PER CARTON (DU)
219562-0039	9P	80

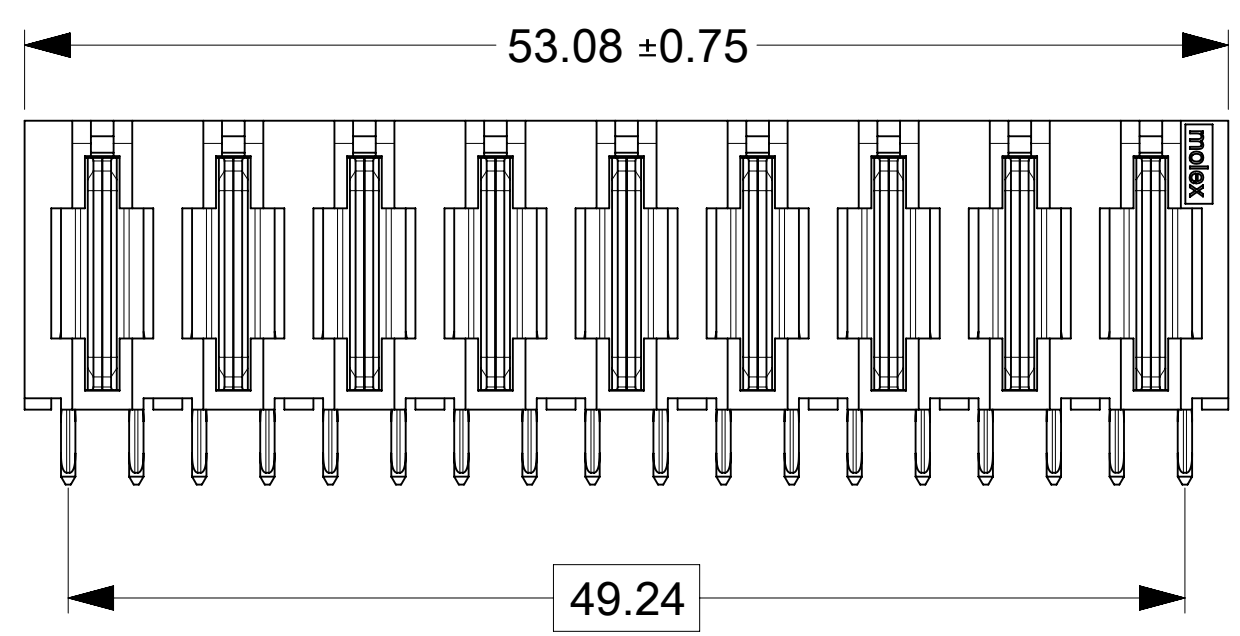

PART NUMBER	CONFIGURATION	QUANTITY PER CARTON (DU)
219562-0040	10P	64

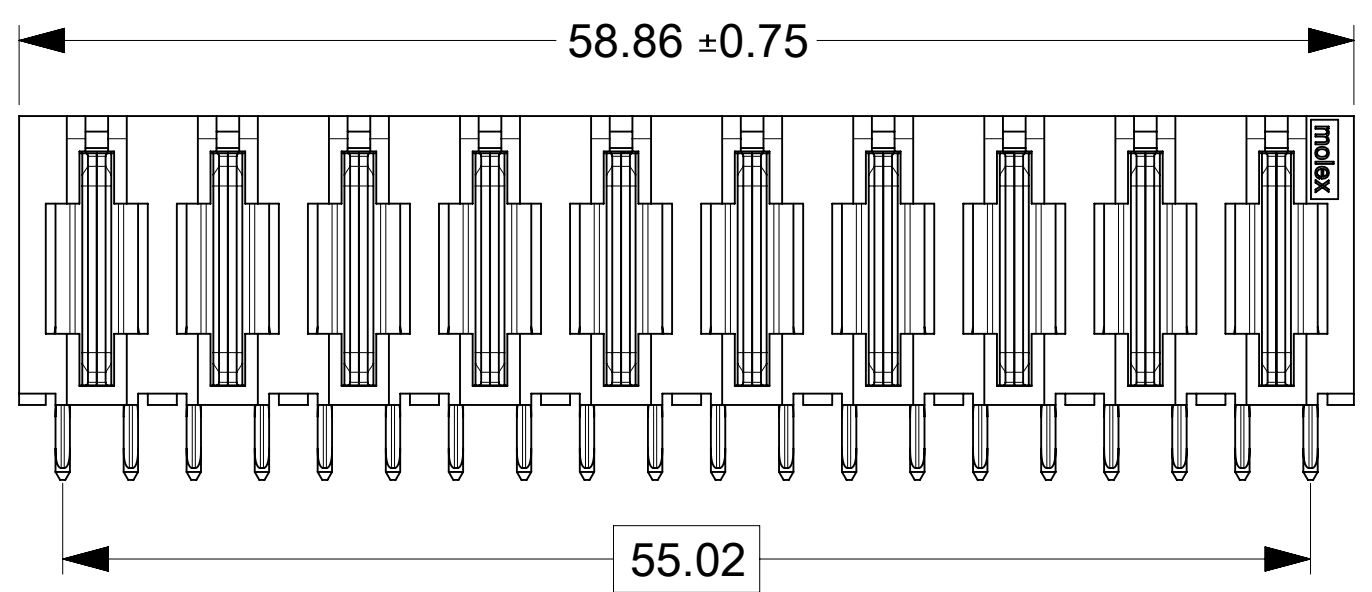

THIS DRAWING CONTAINS INFORMATION THAT IS PROPRIETARY TO MOLEX ELECTRONIC TECHNOLOGIES, LLC AND SHOULD NOT BE USED WITHOUT WRITTEN PERMISSION

DIMENSION UNITS	SCALE	CURRENT REV DESC:	
mm	3:1		
GENERAL TOLERANCES (UNLESS SPECIFIED)			
ANGULAR TOL	±	°	
4 PLACES	±		
3 PLACES	±		
2 PLACES	±	0.25	
1 PLACE	±	0.3	
0 PLACES	±		
DRAFT WHERE APPLICABLE MUST REMAIN WITHIN DIMENSIONS		THIRD ANGLE PROJECTION	DRAWING
			<b>D-SIZE</b>
		SERIES	MATERIAL NUMBER
		219562	SEE CHART
		CUSTOMER	SHEET NUMBER
			2 OF 2

# molex

GUARDIAN HD RA PLUG POWER ONLY  
UNGUIDED PF

PRODUCT CUSTOMER DRAWING

DOCUMENT NUMBER	DOC TYPE	DOC PART	REVISION
2195629003-SD	PSD	000	A1

DOCUMENT STATUS	P1	RELEASE DATE	2023/04/11	17:04:40
-----------------	----	--------------	------------	----------