

10 9 8 7 6 5 4 3 2 1

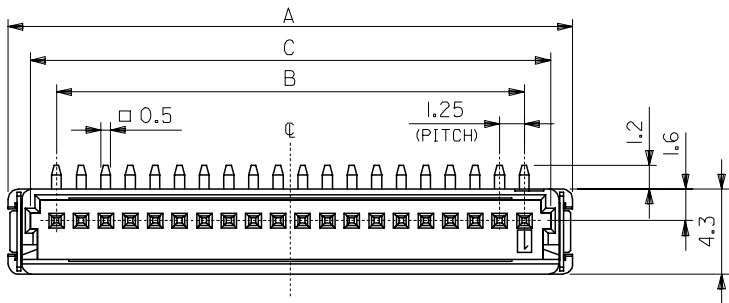

番号 NO.	名称 NAME	原料 MATERIAL	数量 QTY	仕上げ FINISH
①	ウエハー WAFER	ナイロン NYLON	1	UL94V-0
②	ピン PIN	黄銅 BRASS	N	全体錫メッキ PRE-TINNED
③	フィッティングネール FITTING NAIL	黄銅 BRASS	2	錫メッキ TIN PLATING

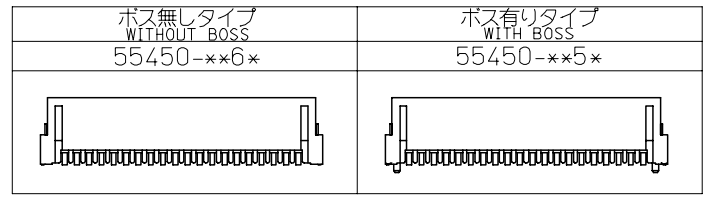

54596-***
リセプトフルアセンブリ
REC. ASS'Y

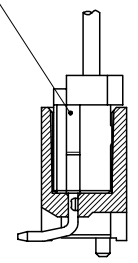

嵌合図
MATING REC.

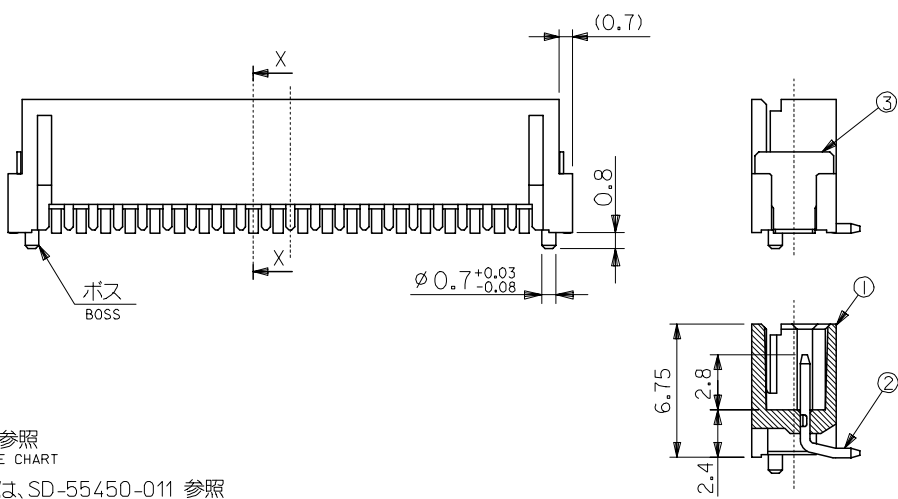

断面 X-X
SECTION X-X

27.05	26.25	26.4	23.75	28.65	20	55450-20**
25.8	25	25.15	22.5	27.4	19	-19**
24.55	23.75	23.9	21.25	26.15	18	-18**
23.3	22.5	22.65	20	24.9	17	-17**
22.05	21.25	21.4	18.75	23.65	16	-16**
20.8	20	20.15	17.5	22.4	15	-15**
19.55	18.75	18.9	16.25	21.15	14	-14**
18.3	17.5	17.65	15	19.9	13	-13**
17.05	16.25	16.4	13.75	18.65	12	-12**
15.8	15	15.15	12.5	17.4	11	-11**
14.55	13.75	13.9	11.25	16.15	10	-10**
13.3	12.5	12.65	10	14.9	9	-09**
12.05	11.25	11.4	8.75	13.65	8	-08**
10.8	10	10.15	7.5	12.4	7	-07**
9.55	8.75	8.9	6.25	11.15	6	-06**
8.3	7.5	7.65	5	9.9	5	-05**
7.05	6.25	6.4	3.75	8.65	4	-04**
5.8	5	5.15	2.5	7.4	3	-03**
4.55	3.75	3.9	1.25	6.15	2	55450-02**
E	D	C	B	A	極数 CIRCUIT SIZE	△ 製品番号 MATERIAL NO.

注) NOTES

1. 原料および仕上げ: 表参照
MATERIAL AND FINISH: SEE CHART
2. インボス梱包品の詳細は、SD-55450-011 参照
REFER TO THE SD-55450-011 FOR THE EMBOSSED PACKAGING.
3. 端子平坦度は 0.15 MA X. とする。
COPLANALITY TO BE 0.15 MAX.

△ 製品番号
MATERIAL NO.

55450-****

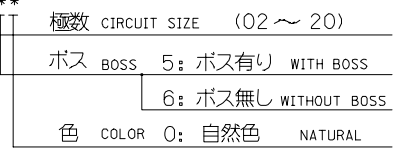

5. 本製品は 55450-**10/**30/**70/**80 の鉛フリー品である。
THIS PRODUCT IS LEAD FREE OF 55450-**10/**30/**70/**80.

REVISED EC NO: J2007-0566 DRWN: OTANI CHKD: NUKITA APPR: NUKITA	DESCRIPTION	GENERAL TOLERANCES (UNLESS SPECIFIED)		DIMENSION STYLE MM ONLY		SCALE 4:1	DESIGN UNITS METRIC	THIRD ANGLE PROJECTION	
		10 UNDER	±0.2	DRAWN BY N. AIDA	DATE '05/02/01	TITLE MINI M12 1-ROW SMT WAFER ASS'Y (TIN) -LEAD FREE-		MOLEX INCORPORATED	
10 OVER 30 UNDER	±0.25	CHECKED BY K. TOJO	DATE '05/02/01	APPROVED BY N. UKITA		DATE '05/02/01	MATERIAL NO. SEE CHART		
30 OVER	±0.3	ANGULAR ±3 °		DRAFT WHERE APPLICABLE MUST REMAIN WITHIN DIMENSIONS		DOCUMENT NO. SD-55450-010		SHEET NO. 1 OF 2	
A	REV	THIS DRAWING CONTAINS INFORMATION THAT IS PROPRIETARY TO MOLEX INCORPORATED AND SHOULD NOT BE USED WITHOUT WRITTEN PERMISSION							

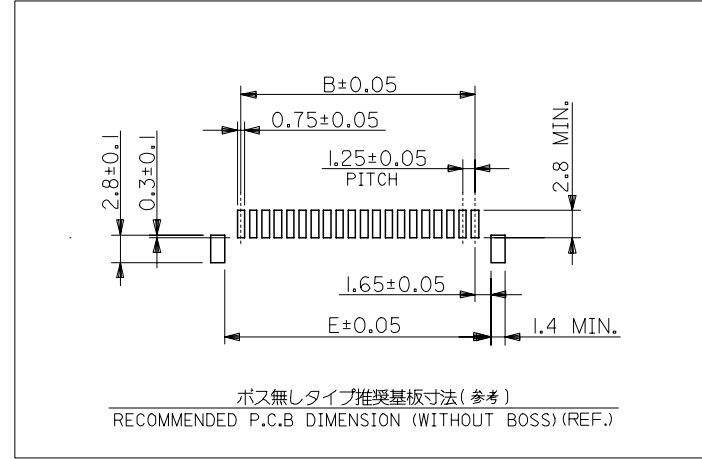
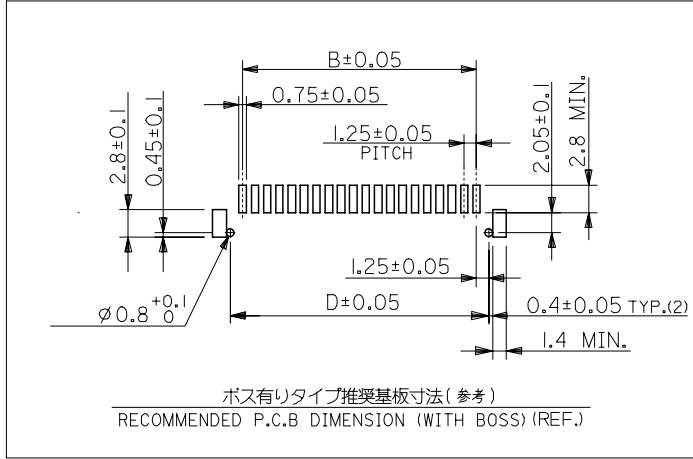

REVISED EC NO: J2007-0566 DRWN: OTANI 2006/09/01 CHK: NUKITA 2006/09/05 APPR: NUKITA 2006/09/08	GENERAL TOLERANCES (UNLESS SPECIFIED)		DIMENSION STYLE MM ONLY		SCALE 4:1	DESIGN UNITS METRIC	THIRD ANGLE PROJECTION	
	10 UNDER	±0.2	DRAWN BY N.AIDA	DATE '05/02/01	TITLE MINI M12 1-ROW SMT WAFER ASS'Y (TIN) -LEAD FREE-			
	10 OVER 30 UNDER	±0.25	CHECKED BY K.TOJO	DATE '05/02/01				
	30 OVER	±0.3	APPROVED BY N.NUKITA	DATE '05/02/01	MOLEX INCORPORATED			
	ANGULAR	±3 °	MATERIAL NO.	DOCUMENT NO. SD-55450-010				
DRAFT WHERE APPLICABLE MUST REMAIN WITHIN DIMENSIONS		SIZE A3	THIS DRAWING CONTAINS INFORMATION THAT IS PROPRIETARY TO MOLEX INCORPORATED AND SHOULD NOT BE USED WITHOUT WRITTEN PERMISSION					