

# KAS-33100-0004 “MUSKIE” MICROPHONE EVALUATION KIT

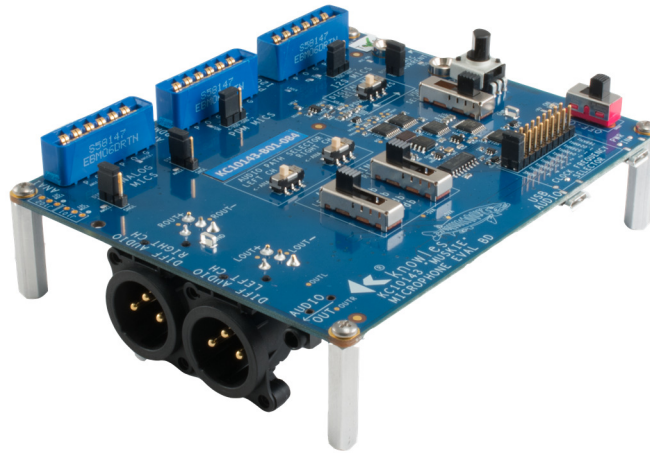

Figure 1: KC10143 Muskie Assembly

## KIT DESCRIPTION

The KAS-33100-0004 Muskie microphone evaluation kit allows for simple and easy evaluation of Knowles SiSonic™ MEMS microphones.

- Evaluate two input channels of audio from multiple MEMS microphone types.
- Microphone types include single and differential Analog MEMS microphones, Digital PDM MEMS microphones, and Digital I2S MEMS microphones.
- Wide dynamic range (varies with microphone types and audio path).
- Selectable Clock Frequencies, Voltages, and Gains.
- Multiple Audio Outputs – XLR, 3.5mm Headset Jack, USB Audio.

## SIMPLE QUICK START

1. Place suitable microphone assembly correctly into socket.
2. Select audio path and audio signal level.
3. Select Mic voltage and digital clock (if applicable).
4. Connect desired output (XLR, Headset, or USB).
5. Connect USB Cable and turn Power On.

## KIT CONTENTS

- KC10143-xxx Muskie Evaluation Board (Note: xxx denotes assembly revision number)
- USB A to USB Micro cable power cable
- KCA2733 Flex Adapter Assembly (3 Total)

**Note: The evaluation kit requires assembled MEMS microphones. Usable assemblies include microphones mounted to “flex” circuit cards or coupon boards. The kit does NOT include assembled Knowles MEMS microphones. Microphone assemblies are available separately from a Knowles distributor.**

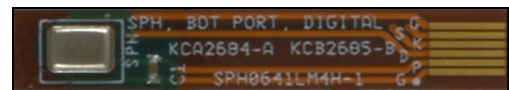

Figure 2: Mic on Flex Assembly Example

For additional Muskie evaluation kit information, electrical documentation, or flex circuit assembly information visit the Knowles website. <https://www.knowles.com/subdepartment/evaluation-kits/dpt-microphones/subdpt-sisonic-surface-mount-mems>.

The Muskie evaluation kit is for the evaluation of the Knowles Electronics' line of MEMS microphones. In some instances the eval kit may limit overall microphone performance.

**THE KITS' INTENDED USE IS TO SUPPORT R&D ACTIVITIES, AND IS NOT INTENDED FOR QUALIFICATION OR PRODUCTION TEST USE.**



## BLOCK DIAGRAM

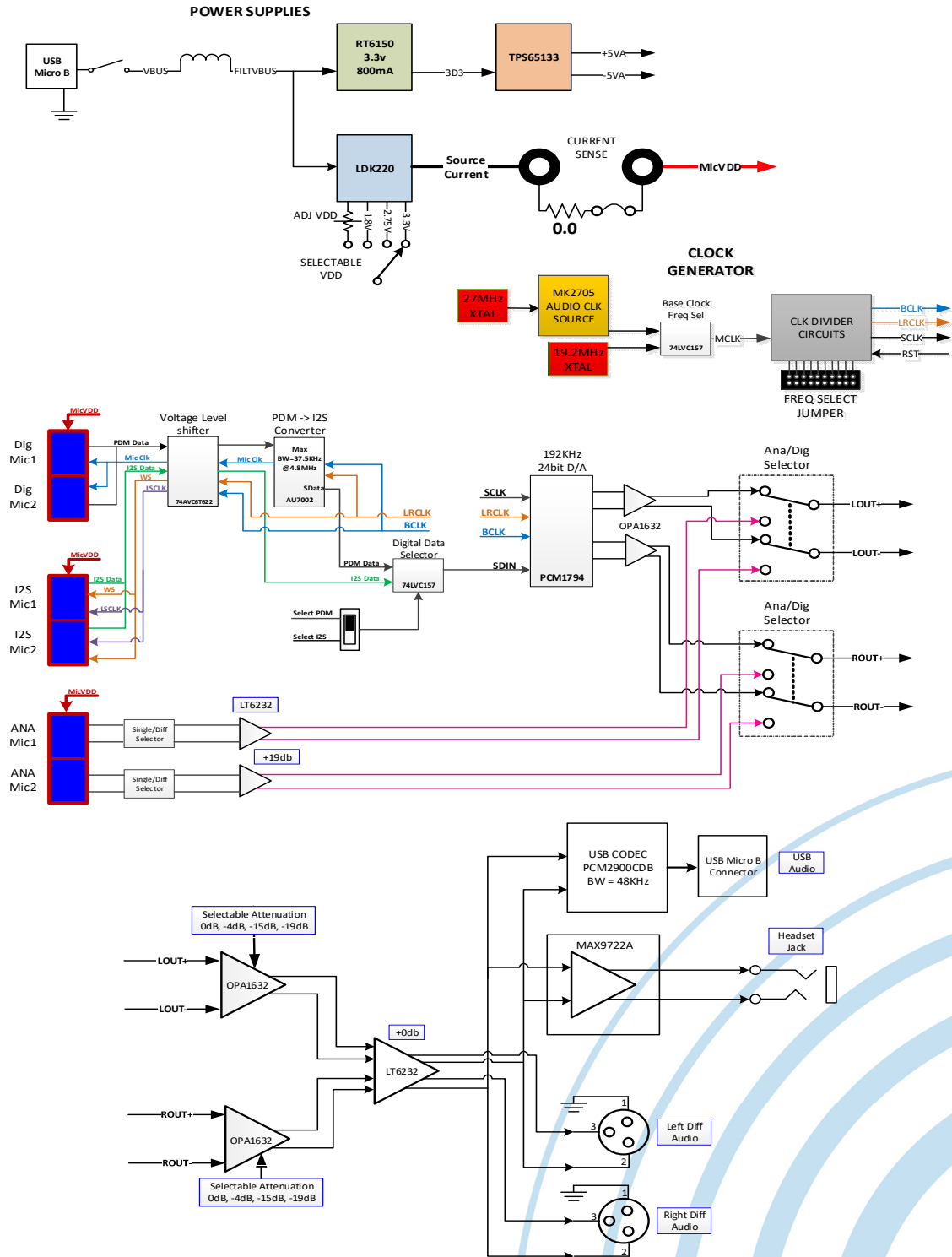

Figure 3: KC10143 Muskie Board Block Diagram



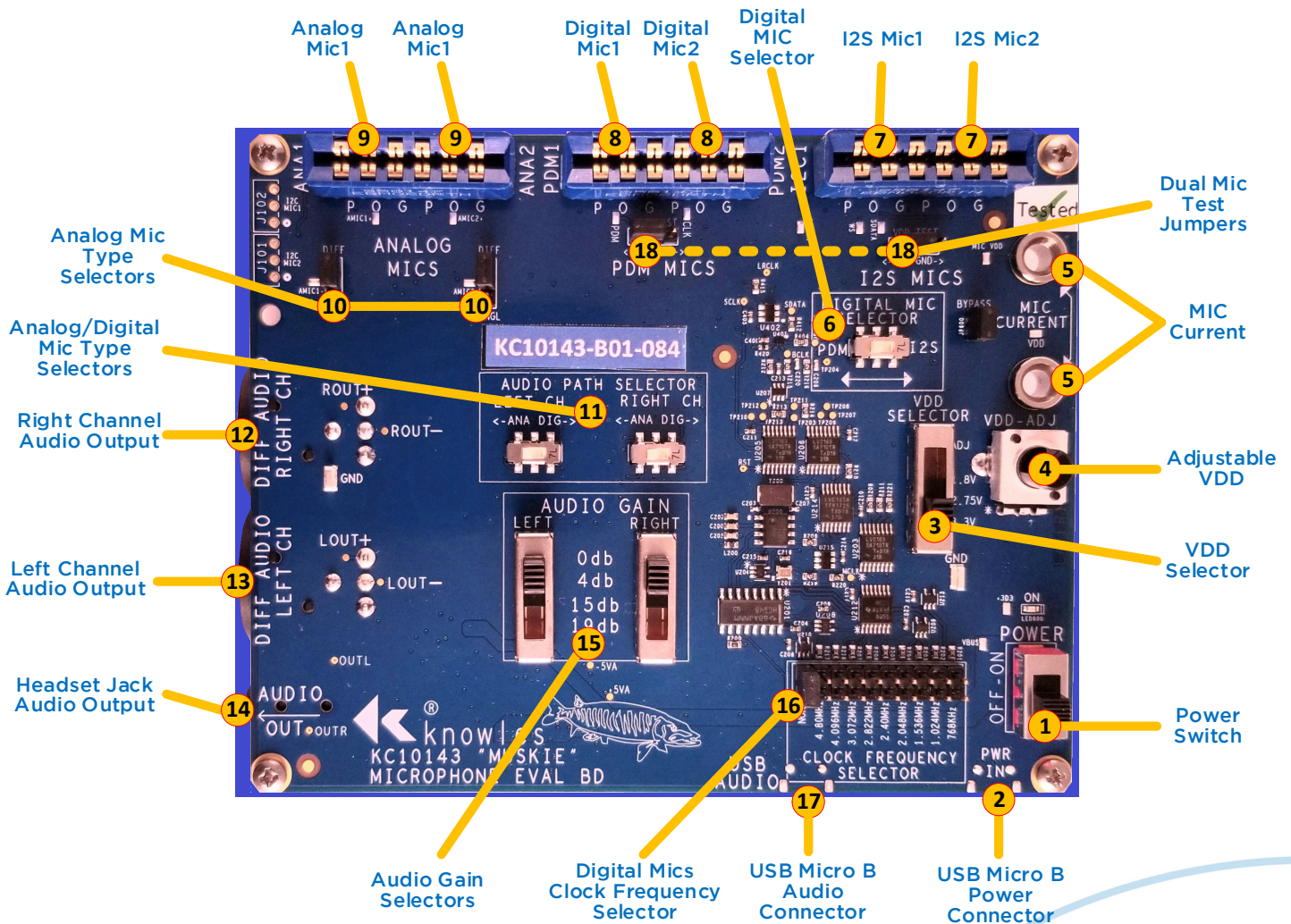

Figure 4: KC10143 Muskie Functional Description

## FUNCTIONAL DESCRIPTION

### 1. Main Power Switch

Slide switch. When placed in the ON position will enable the internal voltage regulators and support circuitry. If all internal supplies power up correctly the POWER GOOD LED will turn on.

### 2. USB connector for main power.

USB Micro B connector. Source power for Muskie board. Knowles recommends using a USB based battery similar to Insignia model # MB5202B for supplying clean power to kit.

### 3. Microphone VDD Selector

Slide switch allows microphone voltage selection. Supports common microphone voltages, +3.3V, +2.75V, and +1.8V. The ADJ selection generates unique VDD voltages.

### 4. Adjustable VDD

Setting the VDD SELECTOR to ADJ enables the VDD-ADJ

potentiometer to generate a custom VDD voltage. The adjustable voltage range is from ~+1.6V to ~+3.65V. Refer to microphone specifications for acceptable input voltages.

### 5. MIC Current Jacks

Banana jack compatible, for measuring current using an external current meter. Note: remove jumper labeled BYPASS to enable.

### 6. Digital MIC Selector

Sets signal path for digital microphones. Select between PDM digital and I2S digital.



**7. I2S Digital Mic Connector**

The socket connector can accommodate a maximum of two coupons. Orient the flex adapter board (KCA2733) to align the “P O G” markings with the “P O G” markings on the Muskie board.

**8. PDM Digital Mic Connector**

The socket connector can accommodate a maximum of two coupons. Orient the flex adapter board (KCA2733) to align the “P O G” markings with the “P O G” markings on the Muskie board.

**9. Analog Mic Connector**

The socket connector can accommodate a maximum of two coupons. Orient the flex adapter board (KCA2733) to align the “P O G” markings with the “P O G” markings on the Muskie board.

**10. Analog Mic Type Selection Jumper**

Select between Analog Differential Mic and Analog Single ended Mic. Left jumper is selector for ANA1 connector socket. Right jumper is selector for ANA2 connector socket.

**11. Analog/Digital Mic Type Selector**

Select independently left and right channels between analog or digital microphone paths.

**12. Right Channel Audio Output**

Right channel differential analog audio output. Audio is output thru a male XLR connector with the following pinouts.  
 Pin 1 – GND  
 Pin 2 – Right channel positive audio signal  
 Pin 3 – Right channel negative audio signal

**13. Left Channel Audio Output**

Left channel differential analog audio output. Audio is output thru a male XLR connector with the following pinouts.  
 Pin 1 – GND  
 Pin 2 – Left channel positive audio signal  
 Pin 3 – Left channel negative audio signal

**14. Headset Audio Output Jack**

3.5mm standard analog headset jack passing stereo audio.

**15. Audio Level Selectors**

Independent left and right channel gain/attenuation settings.

**16. Digital Mics Clock Frequency Selector**

PDM/I2S system clock generator. Select between nine useable digital microphone frequencies.

- 768KHz
- 1.024MHz
- 1.536MHz
- 2.048MHz
- 2.4MHz
- 2.822MHz
- 3.072MHz
- 4.096MHz
- 4.8MHz

NONE – Disables the clock generator circuit.

**17. USB Audio Connector**

USB Micro B connector for steaming USB audio to a PC. The Muskie board uses a generic Windows 7 USB audio driver. No external software driver installation necessary. When connected and powered the device will appear as an USB Audio Codec under the Recording tab of the Sound window.

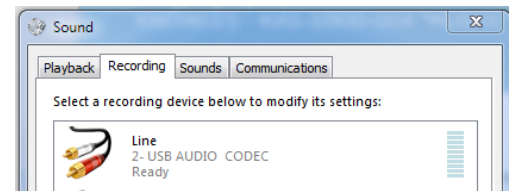

Figure 5: PC Sound Window

**18. Dual Mic Test Jumpers**

PDM2 and I2S2 sockets VDD pin can be set to VDD or GND, independent of PDM1 or I2S1 sockets. Used for stereo Mic VDD testing.



## FLEX ADAPTER (KCA2733)

The KCA2733 flex adapter assembly is comprised of

- One KCB2734 printed circuit board.
- One 0.1µF 10% bypass capacitor.
- One AVX Corp 8 position connector  
Part# 046288008000846+.

Insert the flex microphone into the KCA2733 flex adapter. Flex board is inserted with copper contacts face down. Lock the flex into the adapter by closing the connector.

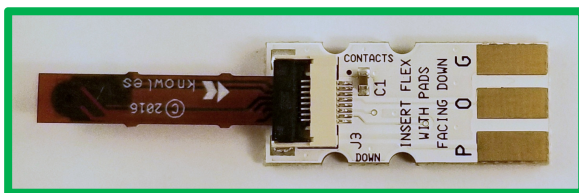

Figure 6: Flex adapter - correct installation of bottom port mic

Note: Flex adapter board's correct insertion orientation.

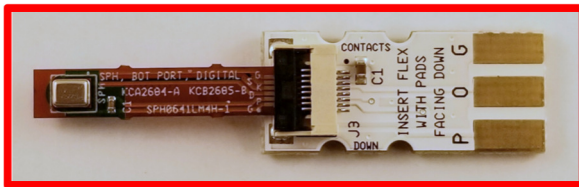

Figure 7: Flex adapter - incorrect installation of bottom port mic

Note: Incorrect flex insertion. The flex PCB traces should NOT be visible.

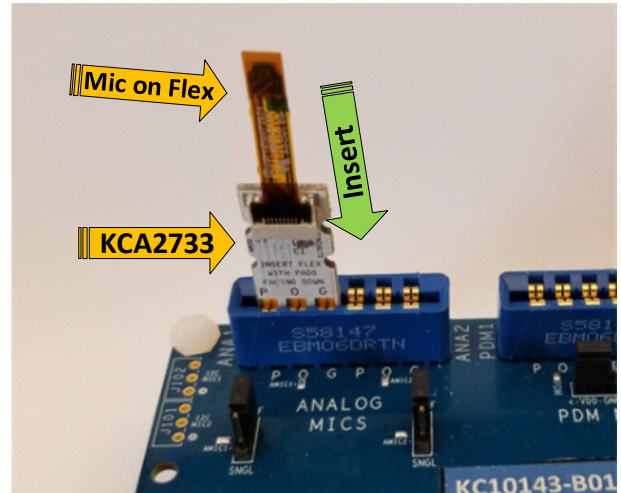

Figure 8: Correct Flex Adapter Insertion into Muskie board

Note: P O G text on flex adapter aligns with P O G text on Muskie board.

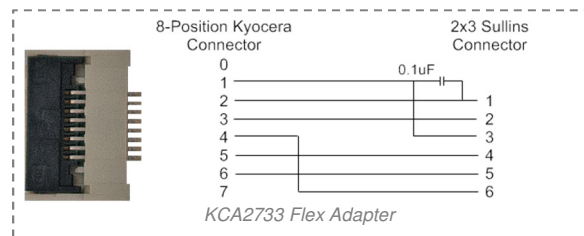

Figure 9: Flex adapter schematic

Refer to Knowles application note AN18 for additional flex/coupon information. AN18 is available at the Knowles website.

<https://www.knowles.com/subdepartment/evaluation-kits/dpt-microphones/subdpt-sisonic-surface-mount-mems>



## TAKING CURRENT MEASUREMENTS

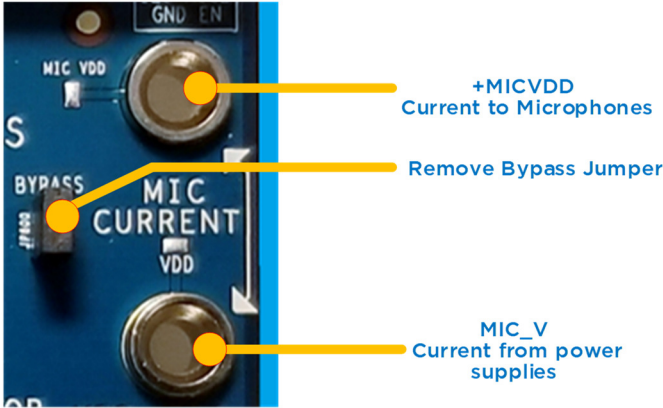

Figure 10: MIC Current Setup

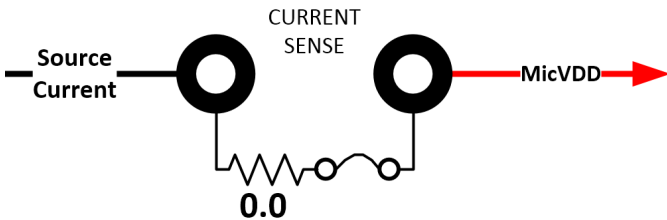

Figure 11: Current sense electrical circuit

- Attach current measuring equipment across the Mic Current terminals.**  
 The terminal located closest to the top of the board is +MICVDD. The other terminal is the power supply source current.

### Remove the BYPASS jumper to enable.

Note: The +MICVDD signal is bussed across all Muskie board microphone connectors. The current measured will be a total of all microphones connected.

## USB AUDIO PATH SETUP

The Muskie board uses a Stereo Audio Codec with USB Interface. The USB controller uses standard Windows/Mac USB audio drivers.

Windows - To verify the USB audio path is functioning connect USB cable from Muskie board USB Audio connector to PC. Slide Muskie board power switch to ON. From the PC, open Control Panel → Hardware and Sound → Sound.

Click on the Recording tab and verify the USB AUDIO CODEC appears.

The bar graph on the right will indicate audio detection when a suitable microphone is plugged in and configured correctly.

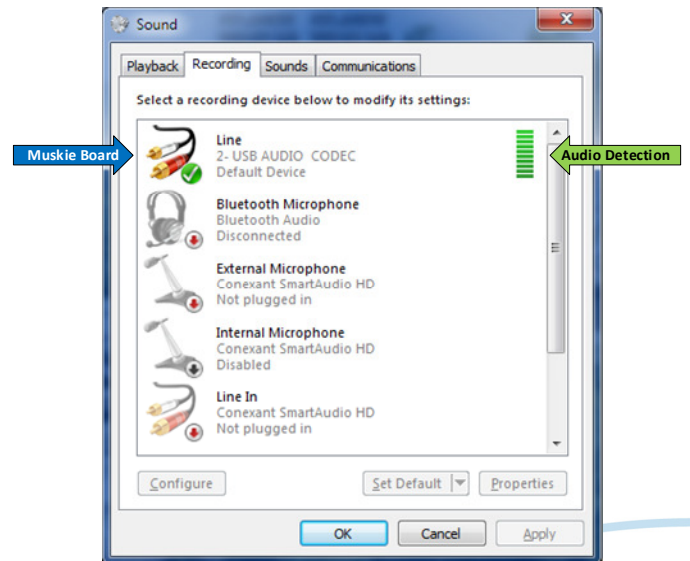

## QUICK START SETTINGS FOR ANALOG MICROPHONES

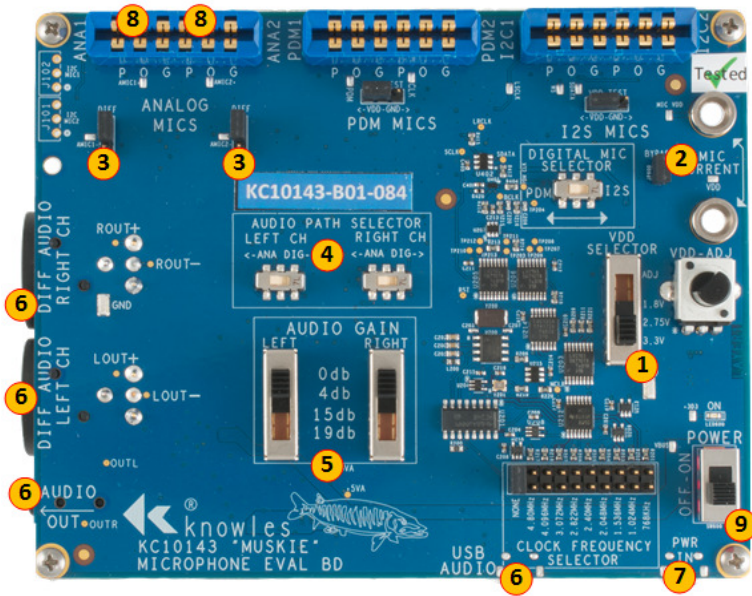

Figure 13: Analog Microphone Setup

The KC10143 Muskie board supports both single ended and differential microphones. Microphone types may be mixed.

1. Set VDD voltage level.
2. Verify Microphone Current Bypass jumper installed. Alternatively see section on Taking Current Measurements.
3. Set analog microphone type. The left jumper posts set microphone type for ANA1 socket. The right jumper posts set microphone type for ANA2 socket. Mixing microphone types is allowed (i.e. 1- Diff Mic, 1-Single ended Mic).
4. Set Audio Path selector to ANA for the corresponding socket.
5. Set signal gain.
6. Make connection to desired audio output. All audio output paths (XLR, Headset, USB) pass audio simultaneously.
7. Insert a suitable 5V power source into USB Power In connector.
8. Insert microphones into socket using the correct orientation. (Align P O G markings)
9. Set power switch to ON.

### Magnitude Response Analog Input - XLR Output

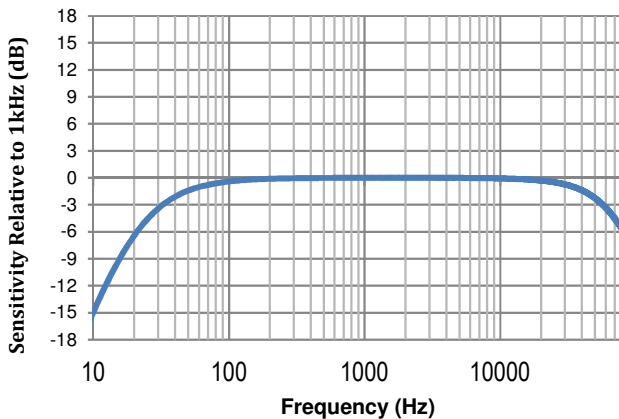

Figure 14: Analog Input – XLR Output

### Magnitude Response Analog Input-Headset Output

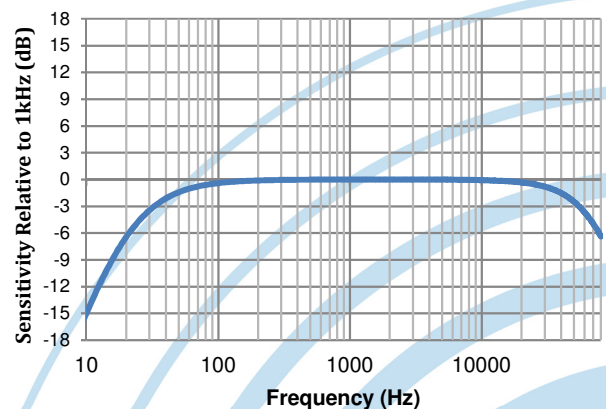

Figure 15: Analog Input – Headset Jack Output



## QUICK START SETTINGS FOR PDM DIGITAL MICROPHONES

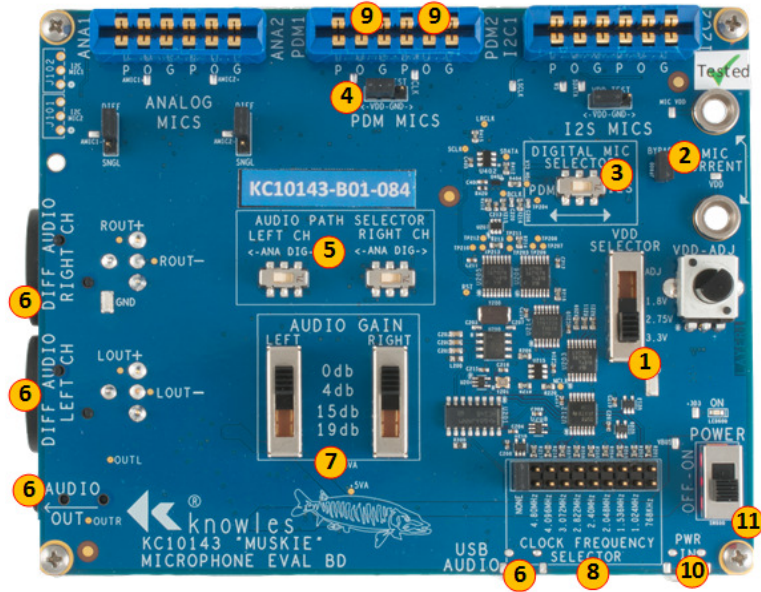

Figure 16: PDM Microphone Setup

The KC10143 Muskie board supports both mono and stereo digital microphone configurations. Microphone types may be mixed.

1. Set VDD voltage level.
2. Verify Microphone Current Bypass jumper installed. Alternatively see section on Taking Current Measurements.
3. Set Digital Mic Selector switch to PDM.
4. Install Mic2 VDD Test Jumper to VDD (default setting).
5. Set Audio Path selector to DIG for the corresponding socket.
6. Make connection to desired audio output. All audio output paths (XLR, Headset, USB) pass audio simultaneously.
7. Set signal gain.
8. Install jumper for desired PDM clock frequency.
9. Insert microphones into socket using the correct orientation.
10. Insert a suitable 5V power source into USB Power In connector.
11. Set power switch to ON

### Magnitude Response PDM Input - XLR Output

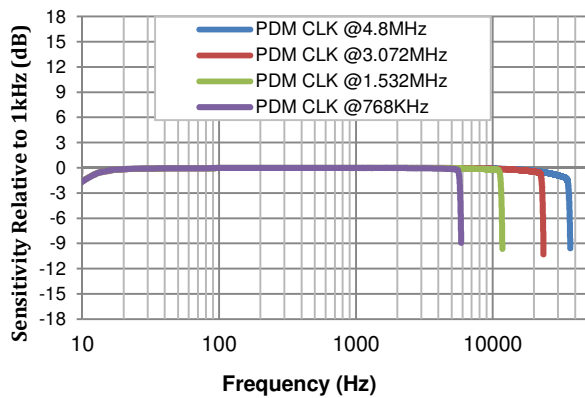

Figure 17: PDM Input – XLR Output

### Magnitude Response PDM Input-Headset Output

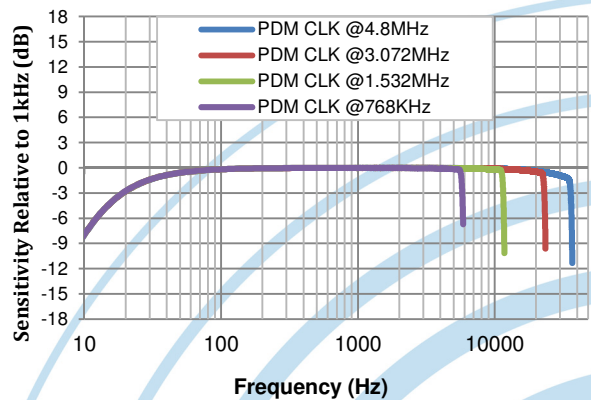

Figure 18: PDM Input – Headset Jack Output





## QUICK START SETTINGS FOR I2S MICROPHONES

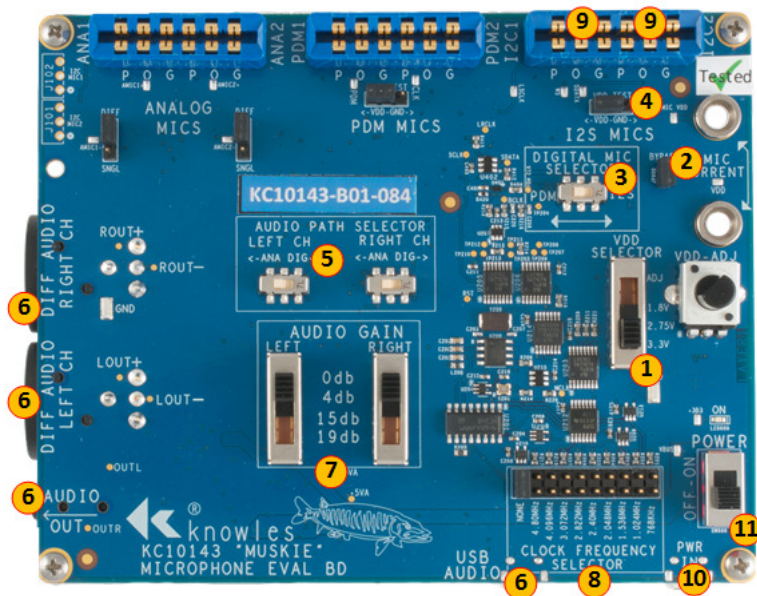

Figure 19: I2S Microphone Setup

1. Set VDD voltage level.
2. Verify Microphone Current Bypass jumper installed. Alternatively see section on Taking Current Measurements.
3. Set Digital Mic Selector switch to I2S.
4. Install VDD Test Jumper to VDD (default setting).
5. Set Audio Path selector to DIG for the corresponding socket.
6. Make connection to desired audio output. All audio output paths (XLR, Headset, USB) pass audio simultaneously.
7. Set signal gain.
8. Install jumper for desired I2S clock frequency.
9. Insert microphones into socket using the correct orientation.
10. Insert a suitable 5V power source into USB Power In connector.
11. Set power switch to ON.

The KC10143 Muskie board supports both mono and stereo digital microphone configurations. Microphone types may be mixed.

### Magnitude Response I2S Input – XLR Output

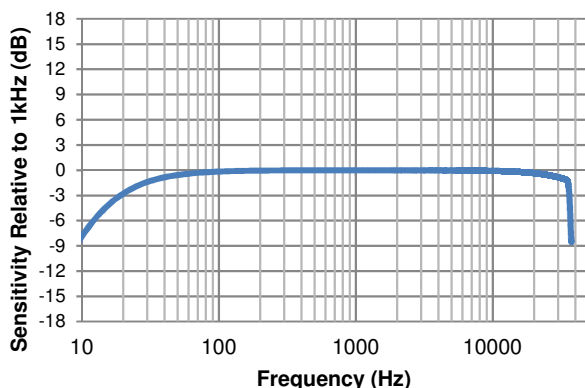

Figure 20: I2S Input – XLR Output

### Magnitude Response I2S Input-Headset Output

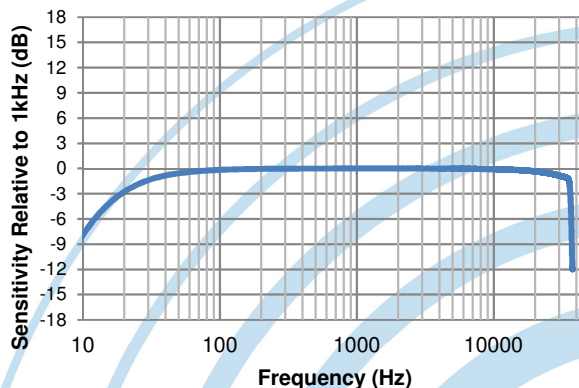
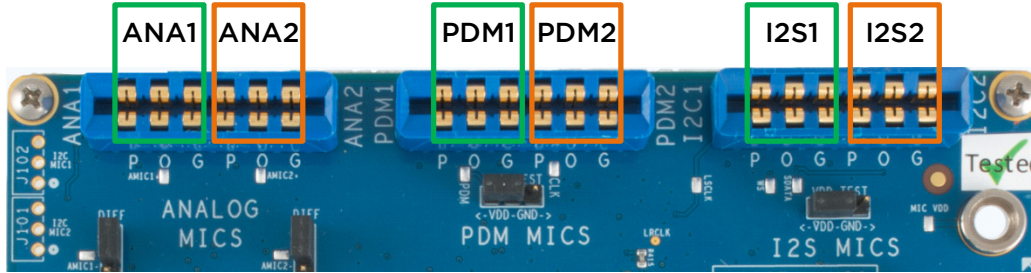

Figure 21: I2S Input – Headset Jack Output



TYPICAL CHARACTERISTICS - OPERATING PERAMETERS



Microphone Compatibility Mapping									
Mic Types	Sullins Connector Socket						Path switch settings		
	ANA 1	ANA 2	PDM 1	PDM 2	I2S1	I2S2	Left Channel	Right Channel	Digital Mic Selector
Analog -Analog	✓	✓					ANA	ANA	N/A
Analog-PDM	✓			✓			ANA	DIG	PDM
Analog-I2S	✓					✓	ANA	DIG	I2C
Analog-PDM		✓	✓				DIG	ANA	PDM
Analog-I2S		✓			✓		DIG	ANA	I2C
PDM-PDM			✓	✓			DIG	DIG	PDM
I2S-I2S					✓	✓	DIG	DIG	I2C

Table 1: Microphone Mapping

Signal Path Throughput

Muskie Audio Signal Path Attenuation (Audio Gain switch set to 0db)		
Audio Type	Audio Path	Approximate Gain @ 1KHz
Analog Single or Differential	XLR	0db
PDM	XLR	-6db(Vrms/FS)
I2S	XLR	-0db(Vrms/FS)
Analog Single or Differential	Headset	-6db
PDM	Headset	-12db(Vrms/FS)
I2S	Headset	-6db(Vrms/FS)
Analog Single or Differential	USB	-34db
PDM	USB	-40db
I2S	USB	-34db

Table 2: Muskie Signal Path

Noise Floor (No Signal)

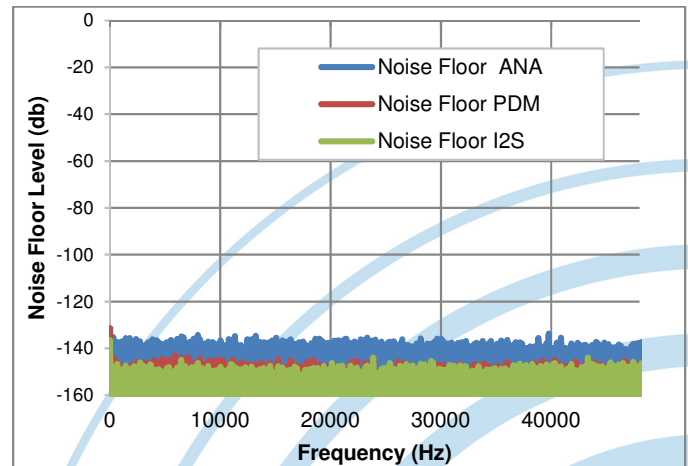

Figure 22: Noise Floor



**Muskie Test Conditions:**

Analog Microphone (Winfrey) connected and powered.  
 Digital Microphone (Cameron) connected and powered.  
 Gain setting = 0db.  
 MicVDD = 3.3V.  
 Output path = XLR  
 External audio source generating 1KHz or 40KHz tones.  
 Clock (if applicable) = 3.0724MHz

**Example: Analog microphone measurement of ambient (room) noise with 1KHz tone.**

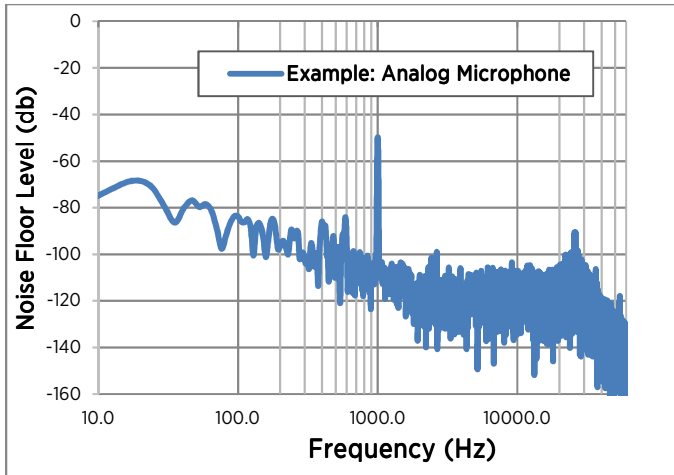

Figure 23: Analog Mic at ambient room with 1KHz signal applied

**Example: Analog ultrasonic microphone measurement of ambient (room) noise with 40KHz tone.**

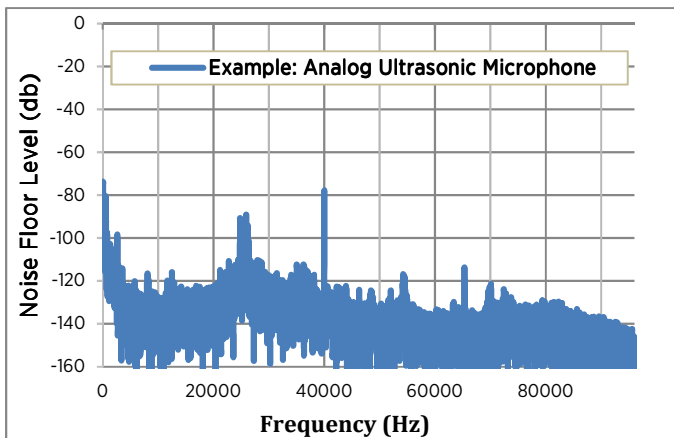

Figure 24: Analog Mic at ambient room with 40KHz signal applied

**Example: PDM microphone measurement of ambient (room), 3.072MHz Clock, and 1KHz tone.**

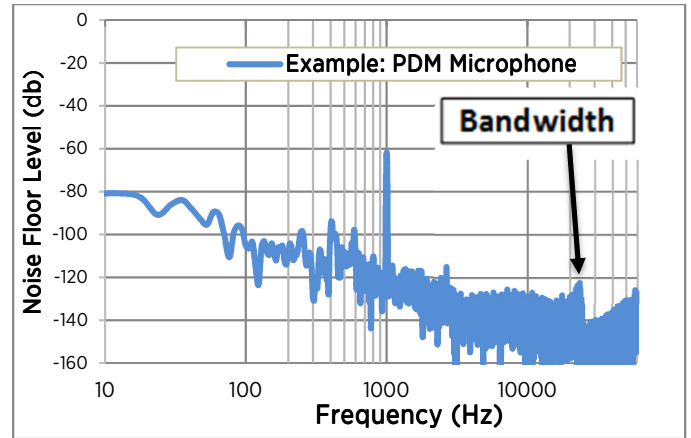

Figure 25: PDM Mic at ambient room with 1KHz signal applied

Note: PDM microphones will have a bandwidth limitation due to the ADAU7002 PDM to I2S converter IC. This limitation will vary with clock frequency.

**Example: PDM microphone measurement of ambient (room), 3.072MHz Clock, and 40KHz tone.**

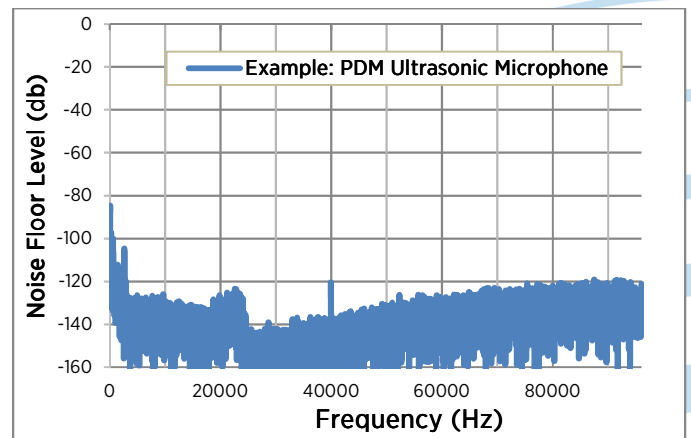

Figure 26: PDM Mic at ambient room with 1KHz signal applied



## INFORMATION

FOR FURTHER INFORMATION ON TECHNOLOGY, DELIVERY TERMS AND CONDITIONS AND PRICES, PLEASE CONTACT A KNOWLES REPRESENTATIVE.

© 2019, KNOWLES ELECTRONICS, LLC, ITASCA, IL USA. ALL RIGHTS RESERVED. KNOWLES AND THE LOGO ARE TRADEMARKS OF KNOWLES ELECTRONICS, LLC.

## DISCLAIMER

THE INFORMATION GIVEN IN THIS DOCUMENT SHALL IN NO EVENT BE REGARDED AS A GUARANTEE OF CONDITIONS OR CHARACTERISTICS. WITH RESPECT TO ANY EXAMPLES GIVEN HEREIN, ANY TYPICAL VALUES STATED HEREIN AND/OR ANY INFORMATION REGARDING THE APPLICATION OF THE DEVICE, KNOWLES ELECTRONICS, LLC HEREBY DISCLAIMS ANY AND ALL WARRANTIES AND LIABILITIES OF ANY KIND, INCLUDING WITHOUT LIMITATION WARRANTIES OF NON-INFRINGEMENT OF INTELLECTUAL PROPERTY RIGHTS OF ANY THIRD PARTY

## REVISION HISTORY

Revision	Description	Date
1	Initial Release	5/23/19
2	Block diagram update	6/28/19
3		
4		
5		