

SUMMARY

Wires

Low voltage 8



Image is for illustrative purpose only

Series 2P
Termination type Male crimp
IP rating 50
AWG wire size 30.00 - 22.00
Cable Ø 5.30 - 7.20 mm
Status active
Matching parts [CLB.M08.GYMG](#)

Download

[Request a quote](#)

[Eplan](#)

[Catalog](#)

TECHNICAL DETAILS

Mechanics

Shell Style/Model CA*: Straight plug with cable collet
Keying 3 keys (alpha=0, gamma=60; Plug: male contacts; Receptacle: female contacts)
Housing Material PSU (Polysulfone), gray
Weight 9.56 g

Performance

Configuration 2P.M08 : 8 Low V.
Insulator Y: PEEK for crimp contacts
Rated Current 10 Amps

Specifications

Test voltage (kV rms) Contact-contact: 1.5
Air clearance min.: 1.55 mm
Creepage distance min.: 1.55 mm

Others

Endurance (Shell): >1000 mating cycles
F ret (min): 150 N
F ret (max): 250 N

LEMO products and services are provided "as is". LEMO makes no warranties or representations with regard to LEMO product & services or use of them, express, implied or statutory, including for accuracy, completeness, or security. The user is fully responsible for his products and applications using LEMO components.

Steam sterilization: 20 times (with potting on rear connection)

DRAWINGS

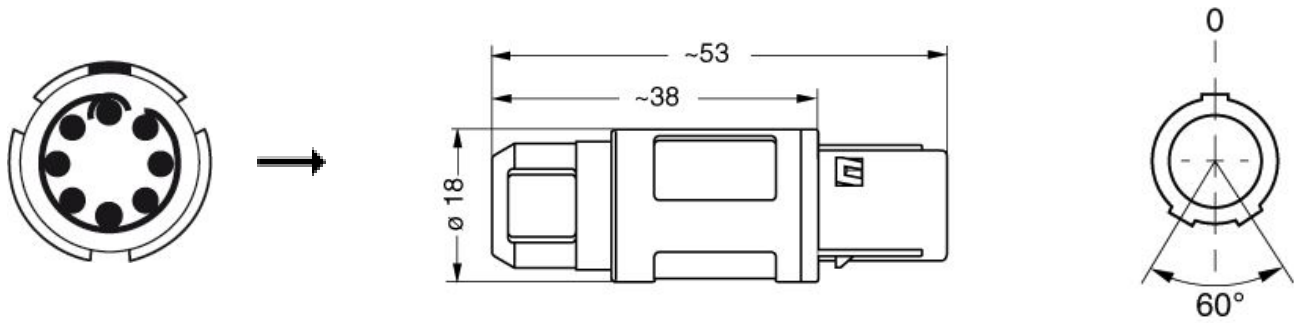

Dimensions

	A	L
mm.	18	53
in.	0,71	2,09

RECOMMENDED BY LEMO









Tools

Crimp Tool:	DPC.91.701.V
Crimp settings:	AWG/Selector = 20-22-24/6-5-5
Positionner:	DCE.91.092.BVC
Extractor:	DCF.91.090.2LT
Replacement contact:	FGG.2B.560.ZZC

Cables

CMN.08.T20.067PGZE		Grey	
CMN.08.T20.067PNZE			

LEMO products and services are provided "as is". LEMO makes no warranties or representations with regard to LEMO product & services or use of them, express, implied or statutory, including for accuracy, completeness, or security. The user is fully responsible for his products and applications using LEMO components.

CMN.08.T22.059QGC	TPR	Grey	
CMN.08.T22.059QGZE	TPR (medical)	Grey	
108220	PVC	Black	
16080	PVC	Grey	
180240	PVC	Black	
180260	PVC	Black	
280250	PVC	Grey	
335990	PVC	Black	
335991	PVC	Black	
42265	PVC	Yellow	
80140	PVC	Grey	

LEMO products and services are provided "as is". LEMO makes no warranties or representations with regard to LEMO product & services or use of them, express, implied or statutory, including for accuracy, completeness, or security. The user is fully responsible for his products and applications using LEMO components.