

Data sheet | Item number: 2022-106

1-conductor female connector; Push-in CAGE CLAMP®; 4 mm²; Pin spacing 5.2 mm; 6-pole; 4,00 mm²; gray

www.wago.com/2022-106

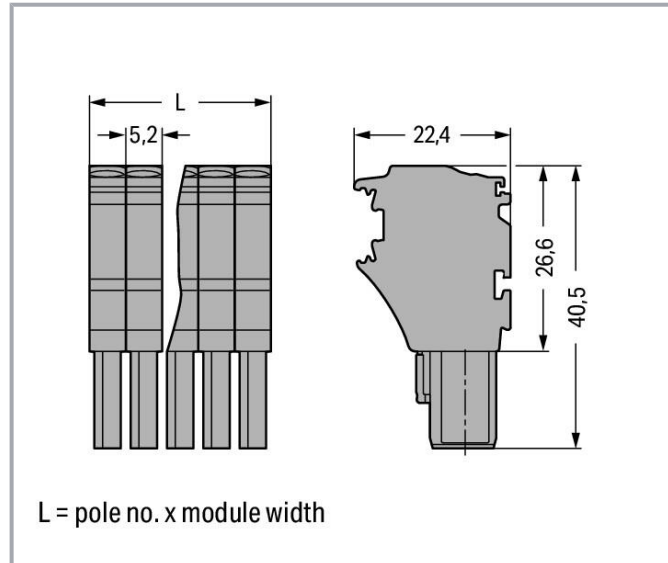
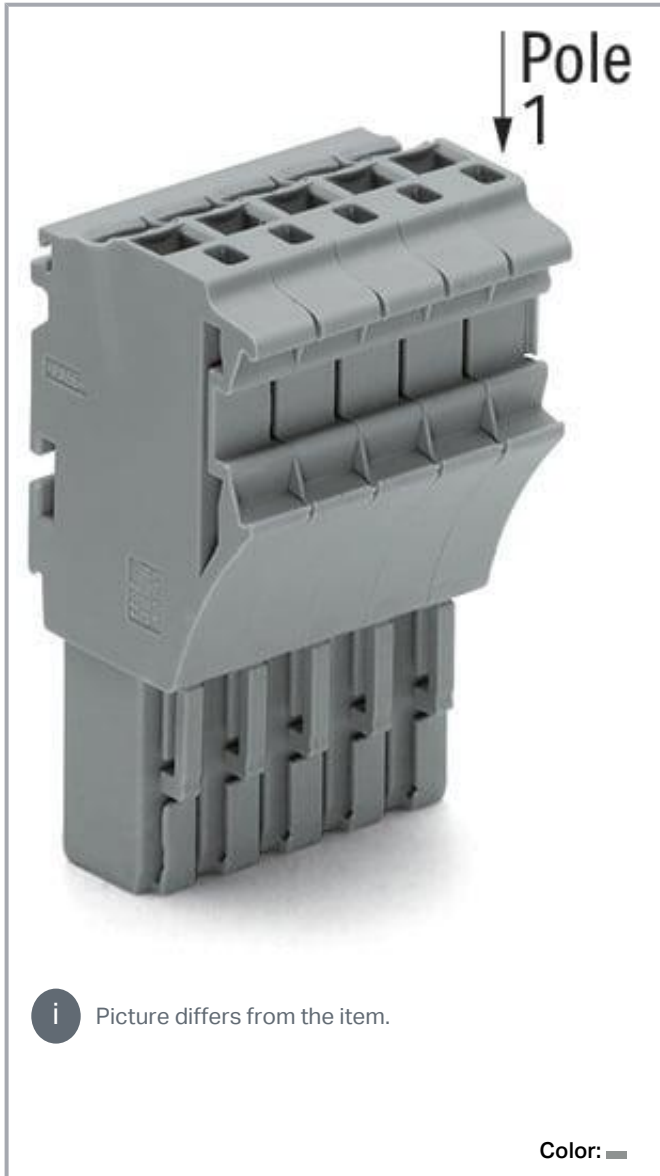

**Data
Notes**

Safety information

According to EN 61984, pluggable connectors without current

Subject to changes. Please also observe the further product documentation!

WAGO GmbH & Co. KG
Hansastr. 27
32423 Minden
Phone: +49571 887-0 | Fax: +49571 887-169
Email: info.de@wago.com | Web: www.wago.com

Do you have any questions about our products?
We are always happy to take your call at +49 (571) 887-44222.



interrupting capacity must not be mated or unmated when live or under load.

Electrical data

Ratings per IEC/EN

Ratings per	IEC/EN 61984
Nominal voltage (III/3)	690 V
Rated impulse voltage (III/3)	6 kV
Rated current	24 A
Current at conductor cross-section (max.) mm ²	32 A
Legend (ratings)	(III / 3) ≙ Overvoltage category III / Pollution degree 3

Ratings per UL 1059

Approvals per	UL 1059
Rated voltage UL (Use Group B)	600 V
Rated current UL (Use Group B)	20 A
Rated voltage UL (Use Group C)	600 V
Rated current UL (Use Group C)	20 A

Ratings per CSA

Approvals per	CSA 22.2 No 158
Rated voltage CSA (Use Group C)	600 V
Rated current CSA (Use Group C)	20 A

Connection data

Connection points	6
Total number of potentials	6

Connection 1

Connection technology	Push-in CAGE CLAMP®
Actuation type	Operating tool
Connectable conductor materials	Copper
Nominal cross-section	2.5 mm ²
Solid conductor	0.25 ... 4 mm ² / 22 ... 12 AWG
Solid conductor; push-in termination	0.75 ... 4 mm ² / 18 ... 12 AWG

Subject to changes. Please also observe the further product documentation!



Fine-stranded conductor	0.25 ... 4 mm ² / 22 ... 12 AWG
Fine-stranded conductor; with insulated ferrule	0.25 ... 2.5 mm ² / 22 ... 14 AWG
Fine-stranded conductor; with ferrule; push-in termination	1 ... 2.5 mm ² / 18 ... 14 AWG
Note (conductor cross-section)	Depending on the conductor characteristic, a conductor with a smaller cross-section can also be inserted via push-in termination.
Strip length	10 ... 12 mm / 0.39 ... 0.47 inches
Pole number	6
Wiring direction	Front-entry wiring

Physical data

Width	31.2 mm / 1.228 inches
Height	40.5 mm / 1.594 inches
Depth	22.4 mm / 0.882 inches
Module width	5.2 mm / 0.205 inches

Mechanical Data

Variable coding	Yes
Marking level	Side marking
Anti-rotation protection	Yes

Plug-in connection

Contact type (pluggable connector)	Female connector/socket
Connector (connection type)	for conductor
Mismating protection	No
Plugging without loss of pin spacing	Yes

Material Data

Note (material data)	Information on material specifications can be found here
Color	gray
Material group	I
Insulation material	Polyamide (PA66)
Flammability class per UL94	V0
Fire load	0.325 MJ
Weight	19.3 g

Subject to changes. Please also observe the further product documentation!

Environmental requirements

Processing temperature	-35 ... +85 °C
Continuous operating temperature	-60 ... +105 °C

Commercial data



eCl@ss 10.0	27-14-11-06
eCl@ss 9.0	27-14-11-06
ETIM 8.0	EC001284
ETIM 7.0	EC001284
PU (SPU)	50 pcs
Packaging type	Box
Country of origin	CN
GTIN	4050821242789
Customs tariff number	85366990990

Environmental Product Compliance

RoHS Compliance Status	Compliant, No Exemption
------------------------	-------------------------

Approvals / Certificates

General approvals

Logo	Approval	Additional Approval Text	Certificate name
	CSA DEKRA Certification B.V.	C22.2 No. 158	2437422
	KEMA/KEUR DEKRA Certification B.V.	EN 61984	71- 101560
	UL Underwriters Laboratories Inc.	UL 1059	E45172

Declarations of conformity and manufacturer's declarations

Logo	Approval	Additional Approval Text	Certificate name
	EU-Declaration of Conformity	-	-

Subject to changes. Please also observe the further product documentation!







WAGO GmbH & Co. KG



UK-Declaration of Conformity

WAGO GmbH & Co. KG



Approvals for marine applications

Logo	Approval	Additional Approval Text	Certificate name
	ABS American Bureau of Shipping	EN 60947	20- HG1941090- PDA
	BV Bureau Veritas S.A.	EN 60947	38586/B0 BV
	DNV GL Det Norske Veritas, Germanischer Lloyd	-	TAE00001V2
	LR Lloyds Register	EN 60947	91/20112 (E9)

Optional accessories

Locking levers

Locking system

	Item no.: 2022-151 Locking lever; gray	www.wago.com/2022-151
	Item no.: 2022-152 Locking lever; orange	www.wago.com/2022-152

Marking accessories

Marking strip

	Item no.: 2009-110 Marking strips; for Smart Printer; on reel; not stretchable; plain; snap-on type; white	www.wago.com/2009-110
--	--	--

Subject to changes. Please also observe the further product documentation!



Item no.: 210-831
Marking strips; on reel; 2.3 mm wide; plain; Self-adhesive; white

www.wago.com/210-831



Item no.: 210-833
Marking strips; 25 m on roll; 6 mm wide; plain; Self-adhesive; white

www.wago.com/210-833



Item no.: 210-834
Marking strips; on reel; 5 mm wide; plain; Self-adhesive; white

www.wago.com/210-834



Item no.: 210-832
Marking strips; on reel; 3 mm wide; plain; Self-adhesive; white

www.wago.com/210-832

Label



Item no.: 210-805
Labels; for Smart Printer; permanent adhesive; 6 x 15 mm; white

www.wago.com/210-805



Item no.: 210-805/000-002
Labels; for Smart Printer; permanent adhesive; 6 x 15 mm; yellow

www.wago.com/210-805/000-002

Marker



Item no.: 2009-115
WMB-Inline; for Smart Printer; 1500 pieces on roll; stretchable 5 - 5.2 mm; plain; snap-on type; white

www.wago.com/2009-115



Item no.: 793-5501
WMB marking card; as card; for terminal block width 5 - 17.5 mm; stretchable 5 - 5.2 mm; plain; snap-on type; white

www.wago.com/793-5501

Tool

Operating tool



Item no.: 210-720
Operating tool; Blade: 3.5 x 0.5 mm; with a partially insulated shaft; multicoloured

www.wago.com/210-720

Insulation stop

Insulation stop



Item no.: 2002-171
Insulation stop; 0.25 - 0.5 mm²; 5 pieces/strip; light gray

www.wago.com/2002-171



Item no.: 2002-172
Insulation stop; 0.75 - 1 mm²; 5 pieces/strip; dark gray

www.wago.com/2002-172

Strain relief

Strain relief plate

Subject to changes. Please also observe the further product documentation!

**Item no.: 734-329**

Strain relief plate; for female and male connectors; 25 mm wide; 1 part; gray

www.wago.com/734-329**Protective warning marker**

Cover

**Item no.: 2002-115**

Protective warning marker; for 5 terminal blocks; with high-voltage symbol, black; yellow

www.wago.com/2002-115**Ferrule**

Ferrule

	Item no.: 216-241 Ferrule; Sleeve for 0.5 mm ² / 20 AWG; insulated; electro-tin plated; electrolytic copper; gastight crimped; acc. to DIN 46228, Part 4/09.90; white	www.wago.com/216-241
	Item no.: 216-242 Ferrule; Sleeve for 0.75 mm ² / 18 AWG; insulated; electro-tin plated; electrolytic copper; gastight crimped; acc. to DIN 46228, Part 4/09.90; gray	www.wago.com/216-242
	Item no.: 216-243 Ferrule; Sleeve for 1 mm ² / AWG 18; insulated; electro-tin plated; electrolytic copper; gastight crimped; acc. to DIN 46228, Part 4/09.90; red	www.wago.com/216-243
	Item no.: 216-244 Ferrule; Sleeve for 1.5 mm ² / AWG 16; insulated; electro-tin plated; electrolytic copper; gastight crimped; acc. to DIN 46228, Part 4/09.90; black	www.wago.com/216-244
	Item no.: 216-263 Ferrule; Sleeve for 1 mm ² / AWG 18; insulated; electro-tin plated; electrolytic copper; gastight crimped; acc. to DIN 46228, Part 4/09.90; red	www.wago.com/216-263
	Item no.: 216-246 Ferrule; Sleeve for 2.5 mm ² / AWG 14; insulated; electro-tin plated; electrolytic copper; gastight crimped; acc. to DIN 46228, Part 4/09.90; blue	www.wago.com/216-246
	Item no.: 216-266 Ferrule; Sleeve for 2.5 mm ² / AWG 14; insulated; electro-tin plated; electrolytic copper; gastight crimped; acc. to DIN 46228, Part 4/09.90; blue	www.wago.com/216-266
	Item no.: 216-264 Ferrule; Sleeve for 1.5 mm ² / AWG 16; insulated; electro-tin plated; electrolytic copper; gastight crimped; acc. to DIN 46228, Part 4/09.90; black	www.wago.com/216-264
	Item no.: 216-284 Ferrule; Sleeve for 1.5 mm ² / AWG 16; insulated; electro-tin plated; electrolytic copper; gastight crimped; acc. to DIN 46228, Part 4/09.90; black	www.wago.com/216-284
	Item no.: 216-286 Ferrule; Sleeve for 2.5 mm ² / AWG 14; insulated; electro-tin plated; electrolytic copper; gastight crimped; acc. to DIN 46228, Part 4/09.90; blue	www.wago.com/216-286
	Item no.: 216-262 Ferrule; Sleeve for 0.75 mm ² / 18 AWG; insulated; electro-tin plated; electrolytic copper; gastight crimped; acc. to DIN 46228, Part 4/09.90; gray	www.wago.com/216-262

Subject to changes. Please also observe the further product documentation!



Downloads Documentation

Bid Text

2022-106 X81 - Datei	2019 May 16	xml 4.2 kB	Download
-------------------------	-------------	---------------	----------

2022-106 docx - Datei	2019 May 14	docx 15.6 kB	Download
--------------------------	-------------	-----------------	----------

Additional Information

Technical Section Technical explanations		pdf 2.2 MB	Download
---	--	---------------	----------

CAD/CAE-Data

CAD data

2D/3D Models 2022-106		URL	Download
-----------------------	--	-----	----------

CAE data

EPLAN Data Portal 2022-106		URL	Download
----------------------------	--	-----	----------

WSCAD Universe 2022-106		URL	Download
-------------------------	--	-----	----------

ZUKEN Portal 2022-106		URL	Download
-----------------------	--	-----	----------

Environmental Product Compliance

Compliance Search

Environmental Product Compliance 2022-106 1-conductor female connector; Push-in CAGE CLAMP®; 4 mm²; Pin spacing 5.2 mm; 6-pole; 4,00 mm²; gray		URL	Download
--	--	-----	----------

Installation Notes

Coding

Subject to changes. Please also observe the further product documentation!

WAGO GmbH & Co. KG
Hansastr. 27
32423 Minden
Phone: +49571 887-0 | Fax: +49571 887-169
Email: info.de@wago.com | Web: www.wago.com

Do you have any questions about our products?
We are always happy to take your call at +49 (571) 887-44222.

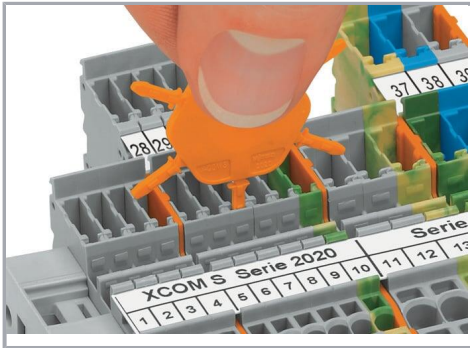

Insert coding pin into the corresponding slot and twist it off.



Coding a female plug: remove coding finger using a suitable tool.

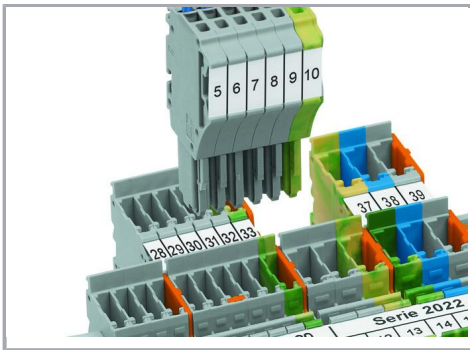

Insert coded female plug into X-COM®S-SYSTEM terminal block assembly.

Locking system

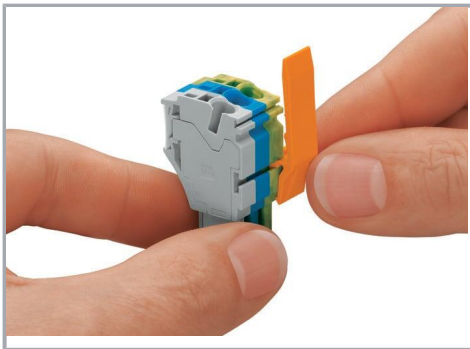

Slide the locking lever into position.

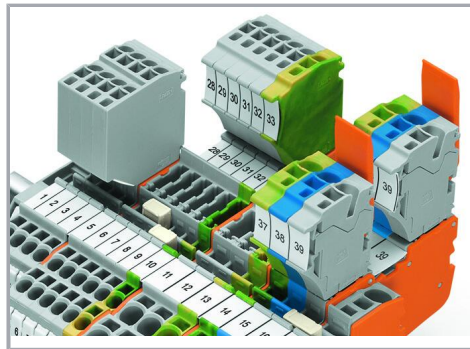

Female plugs can be individually locked.

Product family

Subject to changes. Please also observe the further product documentation!



X-COM S

Show all products from the family

Subject to changes. Please also observe the further product documentation!

WAGO GmbH & Co. KG
Hansastr. 27
32423 Minden
Phone: +49571 887-0 | Fax: +49571 887-169
Email: info.de@wago.com | Web: www.wago.com

Do you have any questions about our products?
We are always happy to take your call at +49 (571) 887-44222.