

Data sheet | Item number: 2001-1306

3-conductor through terminal block; 1.5 mm²; suitable for Ex e II applications; side and center marking; for DIN-rail 35 x 15 and 35 x 7.5; Push-in CAGE CLAMP®; 1,50 mm²; yellow

www.wago.com/2001-1306

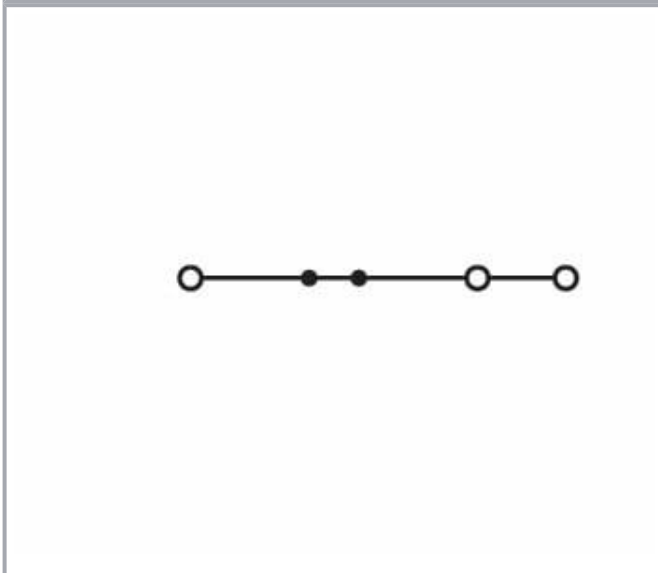
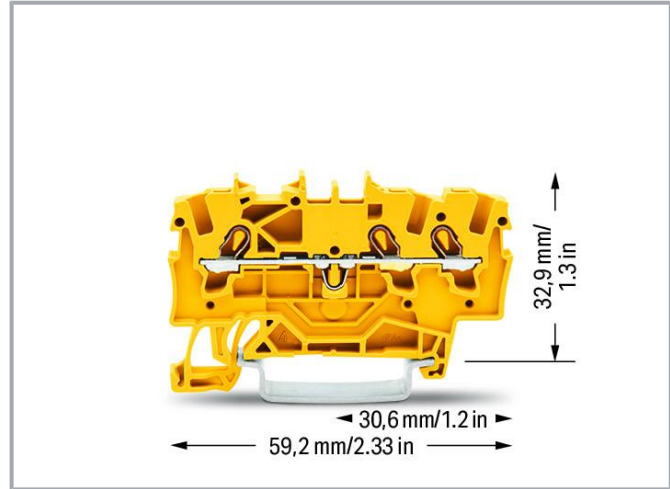
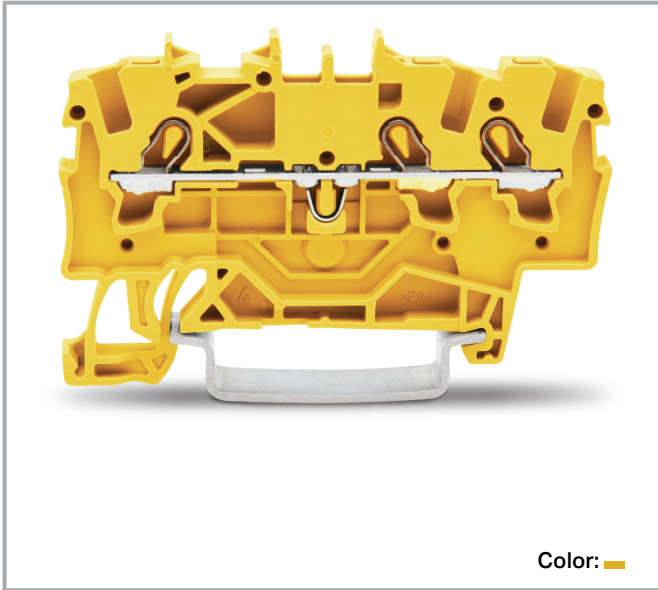

Color: 

Data

Electrical data

Subject to changes. Please also observe the further product documentation!

WAGO GmbH & Co. KG
Hansastr. 27
32423 Minden
Phone: +49571 887-0 | Fax: +49571 887-169
Email: info.de@wago.com | Web: www.wago.com

Do you have any questions about our products?
We are always happy to take your call at +49 (571) 887-44222.



Ratings per IEC/EN

| | |
|---|---|
| Ratings per | IEC/EN 60947-7-1 |
| Nominal voltage (III/3) | 800 V |
| Rated impulse voltage (III/3) | 8 kV |
| Rated current | 18 A |
| Current at conductor cross-section (max.) mm ² | 24 A |
| Legend (ratings) | (III / 3) $\hat{=}$ Overvoltage category III / Pollution degree 3 |

Ratings per UL 1059

| | |
|--------------------------------|---------|
| Approvals per | UL 1059 |
| Rated voltage UL (Use Group B) | 600 V |
| Rated current UL (Use Group B) | 15 A |
| Rated voltage UL (Use Group C) | 600 V |
| Rated current UL (Use Group C) | 15 A |

Ratings per CSA

| | |
|---------------------------------|-----------------|
| Approvals per | CSA 22.2 No 158 |
| Rated voltage CSA (Use Group B) | 600 V |
| Rated current CSA (Use Group B) | 15 A |
| Rated voltage CSA (Use Group C) | 600 V |
| Rated current CSA (Use Group C) | 15 A |

Ex information

| | |
|-------------------------------------|---|
| Reference hazardous areas | See application instructions in section "Knowledge and Downloads – Documentation – Additional Information: Technical Section; Technical Explications" |
| Ratings per | ATEX: PTB 05 ATEX 1094 U / IECEx: PTB 05.0034U (Ex eb IIC Gb) |
| Rated voltage EN (Ex e II) | 550 V |
| Rated current (Ex e II) | 17 A |
| Rated current (Ex e II) with jumper | 16 A |

Power loss

| | |
|--|----------------|
| Power loss, per pole (potential) | 0.593 W |
| Rated current I_N for specified power loss | 18 A |
| Resistance value for specified, current-dependent power loss | 0.002 Ω |

Subject to changes. Please also observe the further product documentation!



Connection data

| | |
|----------------------------|---|
| Connection points | 3 |
| Total number of potentials | 1 |
| Number of levels | 1 |
| Number of jumper slots | 2 |

Connection 1

| | |
|--|---|
| Connection technology | Push-in CAGE CLAMP® |
| Actuation type | Operating tool |
| Connectable conductor materials | Copper |
| Nominal cross-section | 1.5 mm ² |
| Solid conductor | 0.25 ... 2.5 mm ² / 22 ... 14 AWG |
| Solid conductor; push-in termination | 0.75 ... 2.5 mm ² / 18 ... 14 AWG |
| Fine-stranded conductor | 0.25 ... 2.5 mm ² / 22 ... 14 AWG |
| Fine-stranded conductor; with insulated ferrule | 0.25 ... 1.5 mm ² / 22 ... 16 AWG |
| Fine-stranded conductor; with ferrule; push-in termination | 0.75 ... 1.5 mm ² / 18 ... 16 AWG |
| Note (conductor cross-section) | Depending on the conductor characteristic, a conductor with a smaller cross-section can also be inserted via push-in termination. |
| Strip length | 9 ... 11 mm / 0.35 ... 0.43 inches |
| Wiring direction | Front-entry wiring |

Physical data

| | |
|-----------------------------------|------------------------|
| Width | 4.2 mm / 0.165 inches |
| Height | 59.2 mm / 2.33 inches |
| Depth from upper-edge of DIN-rail | 32.9 mm / 1.295 inches |

Mechanical Data

| | |
|---------------|---------------------|
| Mounting type | DIN-35 rail |
| Marking level | Center/side marking |

Material Data

| | |
|----------------------|--|
| Note (material data) | Information on material specifications can be found here |
| Color | yellow |
| Material group | I |

Subject to changes. Please also observe the further product documentation!

| | |
|-----------------------------|------------------|
| Insulation material | Polyamide (PA66) |
| Flammability class per UL94 | V0 |
| Fire load | 0.106 MJ |
| Weight | 4.3 g |

Environmental requirements

| | |
|----------------------------------|-----------------|
| Processing temperature | -35 ... +85 °C |
| Continuous operating temperature | -60 ... +105 °C |

Commercial data



| | |
|-----------------------|---------------|
| Product Group | 22 (TOPJOB S) |
| eCl@ss 10.0 | 27-14-11-20 |
| eCl@ss 9.0 | 27-14-11-20 |
| ETIM 8.0 | EC000897 |
| ETIM 7.0 | EC000897 |
| PU (SPU) | 100 pcs |
| Packaging type | box |
| Country of origin | DE |
| GTIN | 4045454537401 |
| Customs tariff number | 85369010000 |

Environmental Product Compliance



| | |
|------------------------|-------------------------|
| RoHS Compliance Status | Compliant, No Exemption |
|------------------------|-------------------------|

Approvals / Certificates

General approvals

| Logo | Approval | Additional Approval Text | Certificate name |
|--|---------------------------------|--------------------------|--|
|  | CCA DEKRA Certification B.V. | EN 60947 | NTR NL-7963 |
|  | CCC CNEX | GB/T 3836.3 | 2020312313000159 (Ex eb IIC Gb, Ex eb I Mb) |
|  | CSA DEKRA Certification B.V. | C22.2 No. 158 | 1645434 |



Subject to changes. Please also observe the further product documentation!

| | | | |
|--|--|----------|-----------|
|  | KEMA/KEUR DEKRA Certification B.V. | EN 60947 | 71-125954 |
|  | UL UL International Germany GmbH | UL 1059 | E45172 |

Declarations of conformity and manufacturer's declarations

| Logo | Approval | Additional Approval Text | Certificate name |
|---|---|--------------------------|------------------|
|  | EU-Declaration of Conformity WAGO GmbH & Co. KG | - | - |
|  | Railway WAGO GmbH & Co. KG | - | Railway Ready |
|  | UK-Declaration of Conformity WAGO GmbH & Co. KG | - | - |

Approvals for marine applications

| Logo | Approval | Additional Approval Text | Certificate name |
|--|---|--------------------------|------------------|
|  | ABS American Bureau of Shipping | EN 60947 | 20-HG1941090-PDA |
|  | BV Bureau Veritas S.A. | EN 60947 | 38586/B0 BV |
|  | DNV GL Det Norske Veritas, Germanischer Lloyd | - | TAE00001V2 |

Approvals for hazardous areas

| Logo | Approval | Additional Approval Text | Certificate name |
|------|----------|--------------------------|------------------|
|------|----------|--------------------------|------------------|

Subject to changes. Please also observe the further product documentation!

WAGO GmbH & Co. KG
 Hansastr. 27
 32423 Minden
 Phone: +49571 887-0 | Fax: +49571 887-169
 Email: info.de@wago.com | Web: www.wago.com

Do you have any questions about our products?
 We are always happy to take your call at +49 (571) 887-44222.

| | | | |
|---|--|----------------|--|
|  | AEx UL International Germany GmbH c/o Physikalisch Technische Bundesanstalt | UL 60079 | E185892 (AEx e II resp. Ex e II) |
|  | ATEX Physikalisch Technische Bundesanstalt (PTB) | EN 60079 | PTB 05 ATEX 1094 U (II 2 G Ex eb IIC Gb bzw. I M 2 Ex eb I Mb) |
|  | CCC CNEX | GB/T 3836.3 | 2020312313000159 (Ex eb IIC Gb, Ex eb I Mb) |
|  | EAC Brjansker Zertifizierungsstelle | TP TC 012/2011 | RU C-DE.AM02.B. 00127/19 (Ex e IIC Gb U) |
|  | IECEX Physikalisch Technische Bundesanstalt (PTB) | IEC 60079 | IECEX PTB 05. 0034 U (Ex eb IIC Gb or Ex eb I Mb) |
|  | INMETRO TÜV Rheinland do Brasil Ltda. | IEC 60079 | TÜV 12.1308 U |

Required accessories

End plate



End plate

| | | |
|--|--|--|
|  | Item no.: 2002-1391 End and intermediate plate; 0.8 mm thick; gray | www.wago.com/2002-1391 |
|  | Item no.: 2002-1392 End and intermediate plate; 0.8 mm thick; orange | www.wago.com/2002-1392 |



















Optional accessories

Jumpers

Jumper

| | | |
|--|--|--|
|  | Item no.: 210-123 Wire commoning chain; insulated; blue | www.wago.com/210-123 |
|  | Item no.: 2006-499 Step-down jumper; from 2006/2004 to 2004/2002/2001 series; from 2206/2204 to 2204/2202/2201 series; insulated; light gray | www.wago.com/2006-499 |

Subject to changes. Please also observe the further product documentation!

| | | |
|--|--|--|
|  | Item no.: 2001-402 Jumper; 2-way; insulated; light gray | www.wago.com/2001-402 |
|  | Item no.: 2001-403 Jumper; 3-way; insulated; light gray | www.wago.com/2001-403 |
|  | Item no.: 2001-405 Jumper; 5-way; insulated; light gray | www.wago.com/2001-405 |
|  | Item no.: 2001-406/020-000 Delta jumper; insulated; light gray | www.wago.com/2001-406/020-000 |
|  | Item no.: 2001-405/011-000 Star point jumper; 3-way; insulated; light gray | www.wago.com/2001-405/011-000 |
|  | Item no.: 2001-407 Jumper; 7-way; insulated; light gray | www.wago.com/2001-407 |
|  | Item no.: 2001-409 Jumper; 9-way; insulated; light gray | www.wago.com/2001-409 |
|  | Item no.: 2001-406 Jumper; 6-way; insulated; light gray | www.wago.com/2001-406 |
|  | Item no.: 2001-404 Jumper; 4-way; insulated; light gray | www.wago.com/2001-404 |
|  | Item no.: 2001-410 Jumper; 10-way; insulated; light gray | www.wago.com/2001-410 |
|  | Item no.: 2001-433 Jumper; from 1 to 3; insulated; light gray | www.wago.com/2001-433 |
|  | Item no.: 2001-435 Jumper; from 1 to 5; insulated; light gray | www.wago.com/2001-435 |
|  | Item no.: 2001-408 Jumper; 8-way; insulated; light gray | www.wago.com/2001-408 |
|  | Item no.: 2001-437 Jumper; from 1 to 7; insulated; light gray | www.wago.com/2001-437 |
|  | Item no.: 2001-436 Jumper; from 1 to 6; insulated; light gray | www.wago.com/2001-436 |
|  | Item no.: 2001-440 Jumper; from 1 to 10; insulated; light gray | www.wago.com/2001-440 |
|  | Item no.: 2001-438 Jumper; from 1 to 8; insulated; light gray | www.wago.com/2001-438 |
|  | Item no.: 2001-434 | |

Subject to changes. Please also observe the further product documentation!

Jumper; from 1 to 4; insulated; light gray

www.wago.com/2001-434**Item no.: 2001-439**

Jumper; from 1 to 9; insulated; light gray

www.wago.com/2001-439**Item no.: 210-103**

Wire commoning chain; insulated; black

www.wago.com/210-103**Marking accessories**

Marking strip

**Item no.: 2009-110**

Marking strips; for Smart Printer; on reel; not stretchable; plain; snap-on type; white

www.wago.com/2009-110

Marker

**Item no.: 2009-114/000-002**

WMB-Inline; for Smart Printer; 2000 pieces on roll; stretchable 4 - 4.2 mm; plain; snap-on type; yellow

www.wago.com/2009-114/000-002**Item no.: 2009-114/000-005**

WMB-Inline; for Smart Printer; 2000 pieces on roll; stretchable 4 - 4.2 mm; plain; snap-on type; red

www.wago.com/2009-114/000-005**Item no.: 2009-114/000-007**

WMB-Inline; for Smart Printer; 2000 pieces on roll; stretchable 4 - 4.2 mm; plain; snap-on type; gray

www.wago.com/2009-114/000-007**Item no.: 2009-114/000-023**

WMB-Inline; for Smart Printer; 2000 pieces on roll; stretchable 4 - 4.2 mm; plain; snap-on type; green

www.wago.com/2009-114/000-023**Item no.: 2009-114/000-006**

WMB-Inline; for Smart Printer; 2000 pieces on roll; stretchable 4 - 4.2 mm; plain; snap-on type; blue

www.wago.com/2009-114/000-006**Item no.: 2009-114/000-024**

WMB-Inline; for Smart Printer; 2000 pieces on roll; stretchable 4 - 4.2 mm; plain; snap-on type; violet

www.wago.com/2009-114/000-024**Item no.: 2009-114/000-012**

WMB-Inline; for Smart Printer; 2000 pieces on roll; stretchable 4 - 4.2 mm; plain; snap-on type; orange

www.wago.com/2009-114/000-012**Item no.: 2009-114**

WMB-Inline; for Smart Printer; 2000 pieces on roll; stretchable 4 - 4.2 mm; plain; snap-on type; white

www.wago.com/2009-114**Item no.: 793-4501/000-002**

WMB marking card; as card; stretchable 4 - 4.2 mm; plain; snap-on type; yellow

www.wago.com/793-4501/000-002

Subject to changes. Please also observe the further product documentation!

WAGO GmbH & Co. KG

Hansastr. 27

32423 Minden

Phone: +49571 887-0 | Fax: +49571 887-169

Email: info.de@wago.com | Web: www.wago.com

Do you have any questions about our products?

We are always happy to take your call at +49 (571) 887-44222.



Item no.: 793-4501/000-006
WMB marking card; as card; stretchable 4 - 4.2 mm; plain; snap-on type; blue

www.wago.com/793-4501/000-006



Item no.: 793-4501
WMB marking card; as card; stretchable 4 - 4.2 mm; plain; snap-on type; white

www.wago.com/793-4501



Item no.: 793-4501/000-023
WMB marking card; as card; stretchable 4 - 4.2 mm; plain; snap-on type; green

www.wago.com/793-4501/000-023



Item no.: 793-4501/000-024
WMB marking card; as card; stretchable 4 - 4.2 mm; plain; snap-on type; violet

www.wago.com/793-4501/000-024



Item no.: 793-4501/000-005
WMB marking card; as card; stretchable 4 - 4.2 mm; plain; snap-on type; red

www.wago.com/793-4501/000-005



Item no.: 793-4501/000-007
WMB marking card; as card; stretchable 4 - 4.2 mm; plain; snap-on type; gray

www.wago.com/793-4501/000-007



Item no.: 793-4501/000-012
WMB marking card; as card; stretchable 4 - 4.2 mm; plain; snap-on type; orange

www.wago.com/793-4501/000-012



Item no.: 793-4501/000-017
WMB marking card; as card; stretchable 4 - 4.2 mm; plain; snap-on type; light green

www.wago.com/793-4501/000-017

Tool

Operating tool



Item no.: 210-648
Operating tool; Blade: 2.5 x 0.4 mm; with a partially insulated shaft; angled; short

www.wago.com/210-648



Item no.: 210-647
Operating tool; Blade: 2.5 x 0.4 mm; with a partially insulated shaft; multicoloured

www.wago.com/210-647











Item no.: 210-719
Operating tool; Blade: 2.5 x 0.4 mm; with a partially insulated shaft

www.wago.com/210-719

Mounting

Cover carrier

Subject to changes. Please also observe the further product documentation!

| | | |
|--|--|--|
|  | Item no.: 709-169 Cover carrier; Type 3; gray | www.wago.com/709-169 |
| Cover | | |
|  | Item no.: 709-156 Cover; Type 3; suitable for cover carrier, type 3; 1 m long; transparent | www.wago.com/709-156 |
| Ferrule | | |
| Ferrule | | |
|  | Item no.: 216-241 Ferrule; Sleeve for 0.5 mm ² / 20 AWG; insulated; electro-tin plated; electrolytic copper; gastight crimped; acc. to DIN 46228, Part 4/09.90; white | www.wago.com/216-241 |
|  | Item no.: 216-242 Ferrule; Sleeve for 0.75 mm ² / 18 AWG; insulated; electro-tin plated; electrolytic copper; gastight crimped; acc. to DIN 46228, Part 4/09.90; gray | www.wago.com/216-242 |
|  | Item no.: 216-243 Ferrule; Sleeve for 1 mm ² / AWG 18; insulated; electro-tin plated; electrolytic copper; gastight crimped; acc. to DIN 46228, Part 4/09.90; red | www.wago.com/216-243 |
|  | Item no.: 216-244 Ferrule; Sleeve for 1.5 mm ² / AWG 16; insulated; electro-tin plated; electrolytic copper; gastight crimped; acc. to DIN 46228, Part 4/09.90; black | www.wago.com/216-244 |
| Carrier rail | | |
| Mounting accessories | | |
|  | Item no.: 210-197 Steel carrier rail; 35 x 15 mm; 1.5 mm thick; 2 m long; slotted; similar to EN 60715; silver-colored | www.wago.com/210-197 |
|  | Item no.: 210-198 Copper carrier rail; 35 x 15 mm; 2.3 mm thick; 2 m long; unslotted; according to EN 60715; copper-colored | www.wago.com/210-198 |
|  | Item no.: 210-113 Steel carrier rail; 35 x 7.5 mm; 1 mm thick; 2 m long; unslotted; according to EN 60715; silver-colored | www.wago.com/210-113 |
|  | Item no.: 210-118 Steel carrier rail; 35 x 15 mm; 2.3 mm thick; 2 m long; unslotted; according to EN 60715; silver-colored | www.wago.com/210-118 |
|  | Item no.: 210-112 Steel carrier rail; 35 x 7.5 mm; 1 mm thick; 2 m long; slotted; according to EN 60715; "Hole width 25 mm; silver-colored | www.wago.com/210-112 |
|  | Item no.: 210-114 Steel carrier rail; 35 x 15 mm; 1.5 mm thick; 2 m long; unslotted; similar to EN 60715; silver-colored | www.wago.com/210-114 |
|  | Item no.: 210-115 Steel carrier rail; 35 x 7.5 mm; 1 mm thick; 2 m long; slotted; according to EN 60715; "Hole width 18 mm; silver-colored | www.wago.com/210-115 |

Subject to changes. Please also observe the further product documentation!

**Item no.: 210-196**

Aluminum carrier rail; 35 x 8.2 mm; 1.6 mm thick; 2 m long; unslotted; similar to EN 60715; silver-colored

www.wago.com/210-196**Insulation stop**

Insulation stop

**Item no.: 2001-171**Insulation stop; 0.25 - 0.5 mm²; 5 pieces/strip; light graywww.wago.com/2001-171**Push-in type wire jumper**

Jumper

**Item no.: 2009-412**

Push-in type wire jumper; insulated; 60 mm long; black

www.wago.com/2009-412**Item no.: 2009-414**Push-in type wire jumper; 1.5 mm²; insulated; 110 mm long; blackwww.wago.com/2009-414**Item no.: 2009-416**Push-in type wire jumper; 1.5 mm²; insulated; 250 mm long; blackwww.wago.com/2009-416**Item no.: 2009-414/000-005**Push-in type wire jumper; 1.5 mm²; insulated; 110 mm long; blackwww.wago.com/2009-414/000-005**Item no.: 2009-414/000-006**

Push-in type wire jumper; insulated; 110 mm long; black

www.wago.com/2009-414/000-006**Testing and measuring**

Testing accessories

**Item no.: 2009-174**

Test plug adapter; for 4 mm Ø test plugs; for testing TOPJOB®S rail-mounted terminal blocks; gray

www.wago.com/2009-174**Item no.: 2009-182**Testing tap; for max. 2.5 mm²; tool-free connection for individual test wires 0.08 - 2.5 mm; graywww.wago.com/2009-182**Item no.: 2001-511**Modular TOPJOB®S connector; modular; for jumper contact slot; 1-pole; 1,50 mm²; graywww.wago.com/2001-511**Item no.: 2001-554**Modular TOPJOB®S connector; modular; for jumper contact slot; 4-pole; 1,50 mm²; graywww.wago.com/2001-554**Item no.: 2001-549**

Spacer module; modular; e.g., for bridging commoned terminal blocks; gray

www.wago.com/2001-549**Item no.: 2001-556**Modular TOPJOB®S connector; modular; for jumper contact slot; 6-pole; 1,50 mm²; graywww.wago.com/2001-556**Item no.: 2001-557**Modular TOPJOB®S connector; modular; for jumper contact slot; 7-pole; 1,50 mm²; graywww.wago.com/2001-557

Subject to changes. Please also observe the further product documentation!

WAGO GmbH & Co. KG

Hansastr. 27







32423 Minden

Phone: +49571 887-0 | Fax: +49571 887-169

Email: info.de@wago.com | Web: www.wago.com

Do you have any questions about our products?

We are always happy to take your call at +49 (571) 887-44222.

| | | |
|---|---|--|
|  | Item no.: 2001-553 Modular TOPJOB®S connector; modular; for jumper contact slot; 3-pole; 1,50 mm ² ; gray | www.wago.com/2001-553 |
|  | Item no.: 2001-552 Modular TOPJOB®S connector; modular; for jumper contact slot; 2-pole; 1,50 mm ² ; gray | www.wago.com/2001-552 |
|  | Item no.: 2001-558 Modular TOPJOB®S connector; modular; for jumper contact slot; 8-pole; 1,50 mm ² ; gray | www.wago.com/2001-558 |
|  | Item no.: 2001-560 Modular TOPJOB®S connector; modular; for jumper contact slot; 10-pole; 1,50 mm ² ; gray | www.wago.com/2001-560 |
|  | Item no.: 2001-555 Modular TOPJOB®S connector; modular; for jumper contact slot; 5-pole; 1,50 mm ² ; gray | www.wago.com/2001-555 |
|  | Item no.: 2001-559 Modular TOPJOB®S connector; modular; for jumper contact slot; 9-pole; 1,50 mm ² ; gray | www.wago.com/2001-559 |
| Protective warning marker | | |
| Cover | | |
|  | Item no.: 2001-115 Protective warning marker; for 5 terminal blocks; with high-voltage symbol, black; yellow | www.wago.com/2001-115 |

Downloads

Documentation

Bid Text

| | | | |
|---------------------------|-------------|-----------------|----------|
| 2001-1306 X81 - Datei | 2019 Feb 19 | xml 4.0 kB | Download |
| 2001-1306 docx - Datei | 2018 Aug 2 | docx 15.1 kB | Download |

Additional Information

| | | | |
|---|--|---------------|----------|
| Technical Section Technical explanations | | pdf 2.2 MB | Download |
|---|--|---------------|----------|

CAD/CAE-Data

CAE data

| | | | |
|-----------------------------|--|-----|----------|
| EPLAN Data Portal 2001-1306 | | URL | Download |
|-----------------------------|--|-----|----------|

WSCAD Universe 2001-1306

Subject to changes. Please also observe the further product documentation!

WAGO GmbH & Co. KG
Hansastr. 27
32423 Minden
Phone: +49571 887-0 | Fax: +49571 887-169
Email: info.de@wago.com | Web: www.wago.com

Do you have any questions about our products?
We are always happy to take your call at +49 (571) 887-44222.

| | | |
|------------------------|---------------------|--------------------------|
| | URL | Download |
| ZUKEN Portal 2001-1306 | URL | Download |
| CAD data | | |
| 2D/3D Models 2001-1306 | URL | Download |

Environmental Product Compliance

Compliance Search

| | | |
|---|---------------------|--------------------------|
| Environmental Product Compliance 2001-1306 | URL | Download |
| 3-conductor through terminal block; 1.5 mm ² ; suitable for Ex e II applications; side and center marking; for DIN-rail 35 x 15 and 35 x 7.5; Push-in CAGE CLAMP®; 1,50 mm ² ; yellow | | |

Installation Notes

Conductor termination

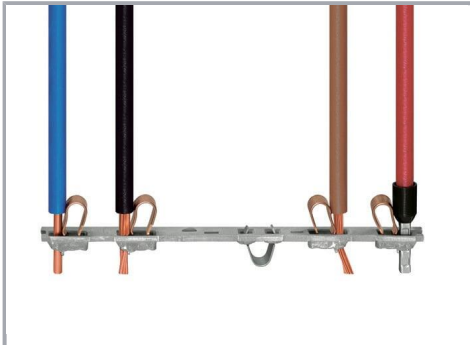

All conductor types at a glance

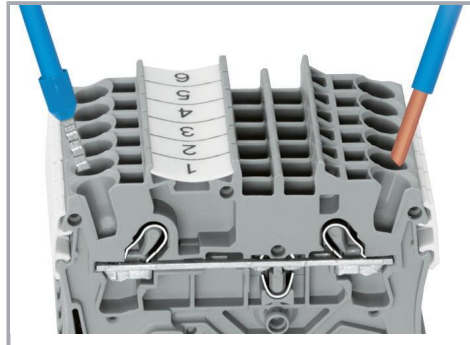

Push-in termination of solid and ferruled conductors

Subject to changes. Please also observe the further product documentation!

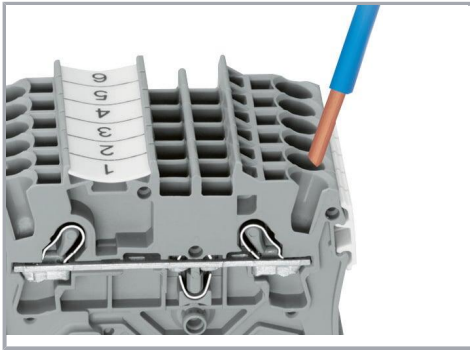

Inserting a conductor via push-in termination:

Solid conductors with cross-sections from either one size above, or up to two sizes below, the rated cross-section can be simply pushed in – no tools needed.

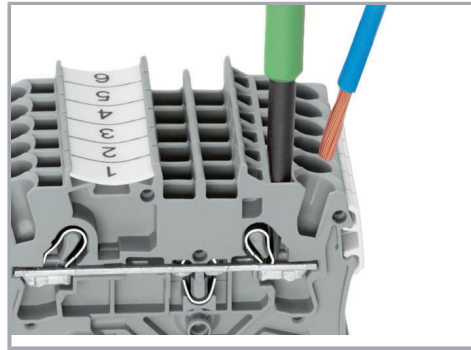

Inserting a conductor via operating tool:

Connecting fine-stranded conductors without ferrules, or small cross-sectional conductors that cannot be pushed in, is performed similarly to the original CAGE CLAMP® – just use an operating tool.

Advantage:

To open the clamp, the operating tool is inserted vertically. The conductor entry is less than 15 degrees for easier wiring.

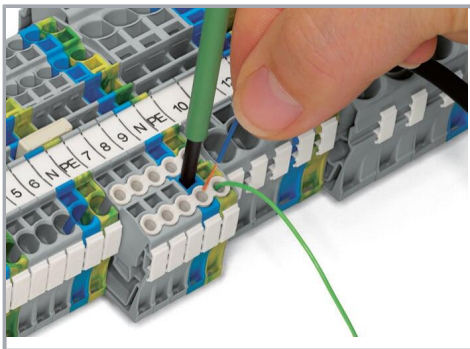

Conductor termination – insulation stop

Commoning

Subject to changes. Please also observe the further product documentation!

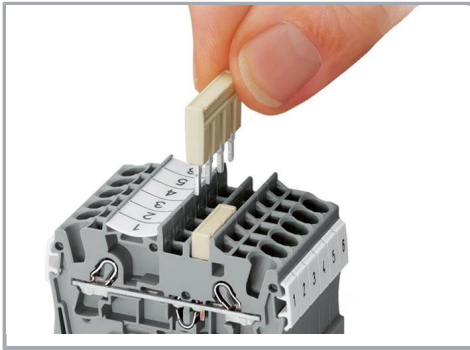

Insert push-in type jumper bar and push down until it hits backstop.

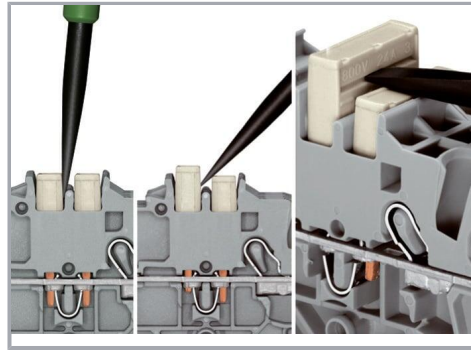

Removing a push-in type jumper bar:

Insert the operating tool between the jumper and partition wall of the dual jumper slots, then lift up the jumper.

Place the operating tool in the center of jumpers for up to five contacts (see above), or alternately on both sides for jumpers with more than five contacts.

Commoning

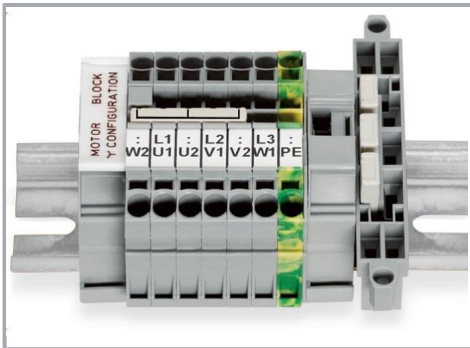

This star point jumper has been specially developed to create a "star point" and is used on motor terminal boards equipped with Rail-Mount Terminal Blocks TOPJOB® S.

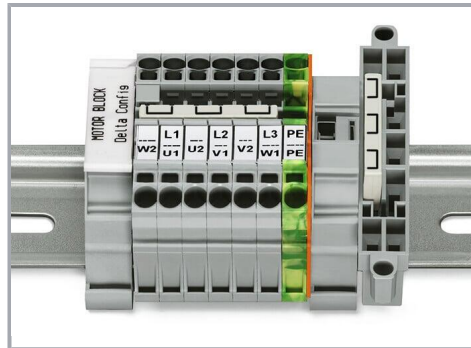

This delta jumper has been specially developed to create a delta configuration and is used on motor terminal boards equipped with rail-mount terminal blocks TOPJOB® S.

Subject to changes. Please also observe the further product documentation!

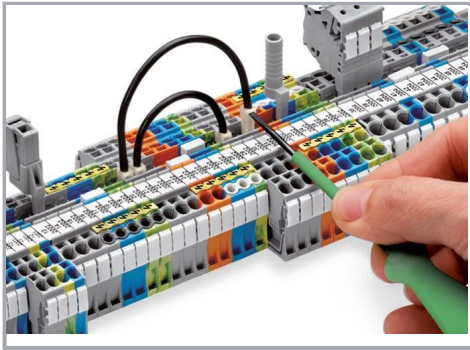

Push down the wire jumper until fully inserted. Lift the jumper with an operating tool for rewiring.

Commoning

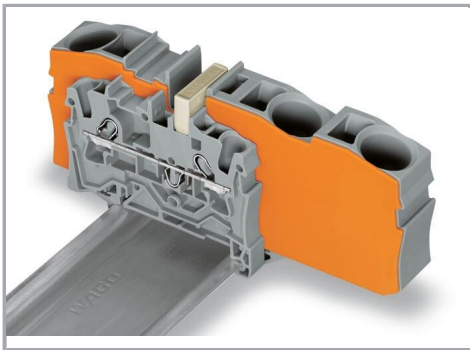

Step-down jumpers common terminal blocks of different sizes, without losing a conductor clamping point. This can be beneficial on long conductor runs where voltage drop can be a problem. A large conductor can be easily connected to smaller conductors at the distribution point.

Commoning may be made in either direction using the special thin end plate to cover the open side. Additional through terminal blocks having a smaller cross-section may be commoned using push-in type jumper bars.

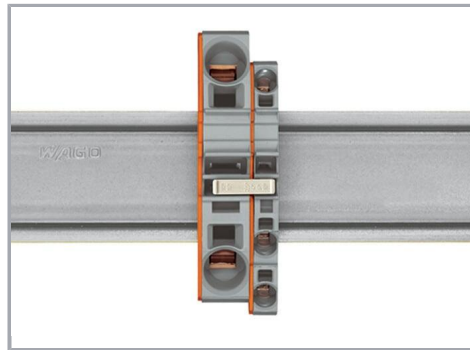

Using step-down jumpers, an end plate must be inserted between the terminal blocks to be commoned.

Subject to changes. Please also observe the further product documentation!



Step-down jumper (2006-499) commons 6 /4 mm² (10/12 AWG) terminal blocks (2006 /2004 Series) with 4/2.5/1.5 mm² (AWG 12/14 /16) terminal blocks (2004/2002/2001 Series).

Step-down jumper (2016-499) commons 16 /10 mm² (16/8 AWG) terminal blocks (2016 /2010 Series) with 10/6/4/2.5 mm² (8/10/12/14 AWG) terminal blocks (2010/2006/2004/2002 Series).

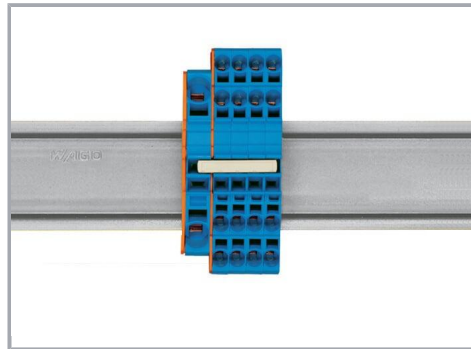
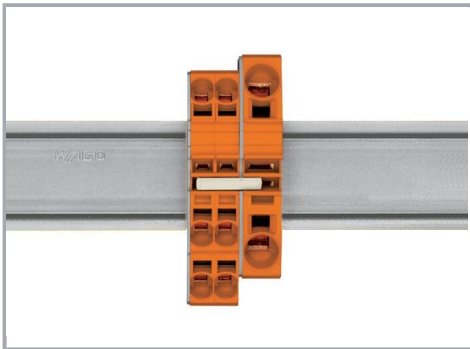

Stepping down via push-in type jumper bar:

Stepping down via push-in type jumper bar:

Commoning via open terminal side with end plate allows jumpering over two cross-section sizes for 16 mm² (6 AWG) and 10 mm² (8 AWG) and one cross-section size for 6/4/2.5 mm² (10 /12/14 AWG). An example: from 16 mm² (6 AWG) to 6 mm² (10 AWG) (see illustration above) or from 10 mm² (8 AWG) to 4 mm² (12 AWG).

Commoning via closed terminal side with end plate allows jumpering over two cross-section sizes, e.g., from 16 mm² (6 AWG) to 6 mm² (10 AWG) or from 6 mm² (10 AWG) to 2.5 mm² (14 AWG) (see illustration above).

Subject to changes. Please also observe the further product documentation!

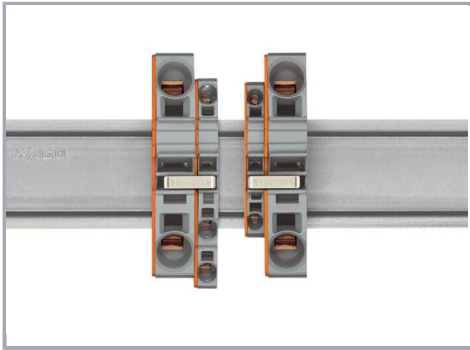

Note:

The total current of the outgoing circuits must not exceed the nominal current of the step-down jumper/push-in type jumper bar.

Testing

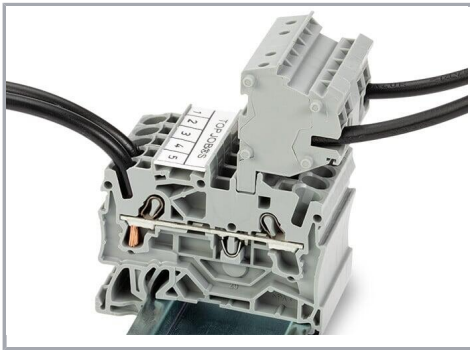

The modular TOPJOB® S connectors also connect conductors of the same size as the terminal blocks being used.

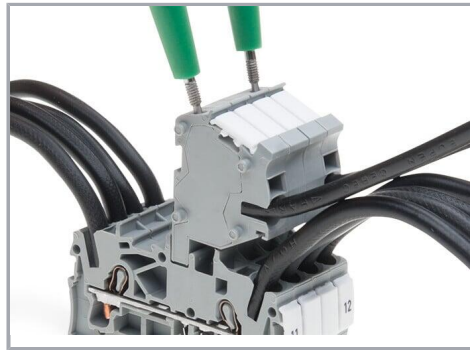

TOPJOB® S Connectors with a 2 mm Ø test socket for testing voltage via 2-pole voltage tester

Subject to changes. Please also observe the further product documentation!

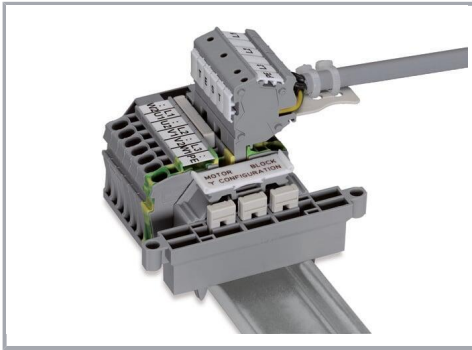

Rail-mount terminal block assembly for electric motor wiring

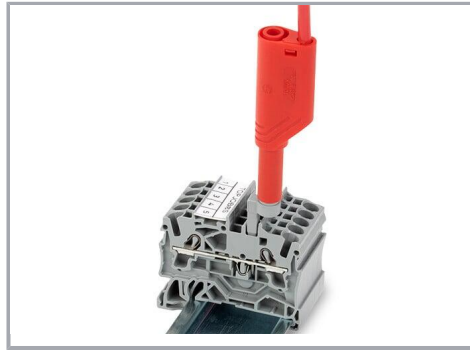

Test plug adapter (2009-174, CAT I) for 4 mm Ø plugs – compatible with 2000 to 2016 Series

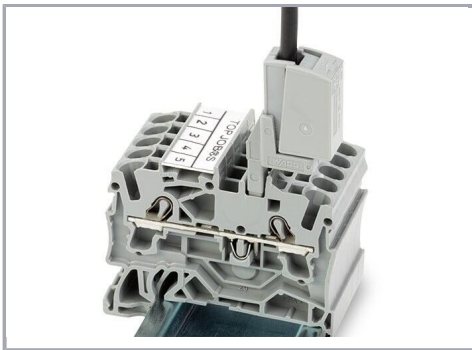

Testing tap (2009-182) for tool-free connection of test cables up to 2.5 mm² (12 AWG) – compatible with 2000 to 2016 Series

Marking

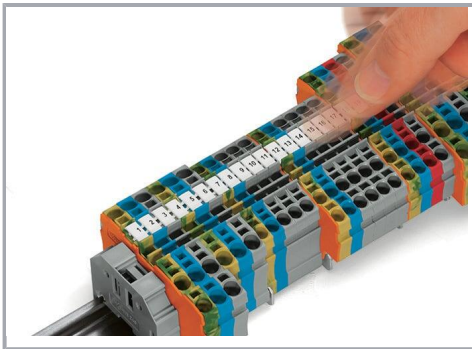

Snapping WMB Inline markers into marker slots.

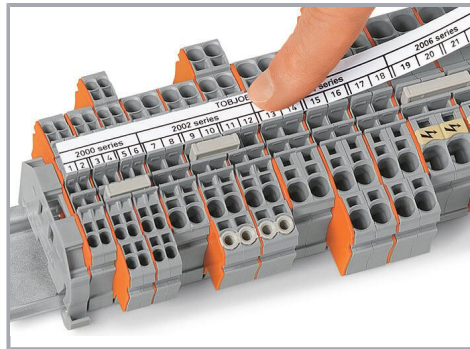

Subject to changes. Please also observe the further product documentation!



All through and ground conductor terminal blocks are suitable for Ex e II applications.

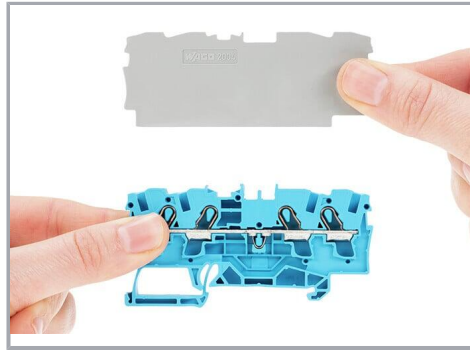

Separator plate for Ex e/Ex i applications

An end plate must be applied to the terminal block located directly behind an Ex e/Ex i separator plate.



Ex e II/Ex i terminal strip

Note:

The movable feet of terminal blocks and separator plates must face the same direction.



A separator plate is located between the Ex e II and Ex i terminal strip.

End plate

Ex e II terminal blocks

Separator plate for Ex e/Ex i applications

End plate

Ex i terminal blocks

According to EN 50020, a minimum distance of 50 mm must be kept between live parts of Ex e and Ex i circuits. The use of Ex e/Ex i separators is a space-saving solution when Ex e and Ex i terminal blocks are mounted on a common DIN-rail.

Product family

Subject to changes. Please also observe the further product documentation!



TOPJOB® S

TOPJOB® S: In various industrial applications and modern building installations, WAGO's wide and versatile range of rail-mount terminal blocks provides more than just reliable electrical connections.

[Show all products from the family](#)

Subject to changes. Please also observe the further product documentation!

WAGO GmbH & Co. KG
Hansastr. 27
32423 Minden
Phone: +49571 887-0 | Fax: +49571 887-169
Email: info.de@wago.com | Web: www.wago.com

Do you have any questions about our products?
We are always happy to take your call at +49 (571) 887-44222.