

DO NOT SCALE FROM THIS PRINT

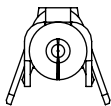

ALL DIMENSIONS ARE REFERENCE
(SEE T-1M74-X-XX-X FOR CONTROL PRINT)

T1M74-X-XX-X

SUPPLIED
-L: LOOSE
-R: REEL

PLATING SPECIFICATION
-F: FLASH SELECTIVE GOLD
-L: LIGHT SELECTIVE GOLD
-S: SELECTIVE GOLD

LEAD STYLE
-01: 26-30 AWG
-02: 20-24 AWG
-03: 28-30 AWG (PTFE/FEP)

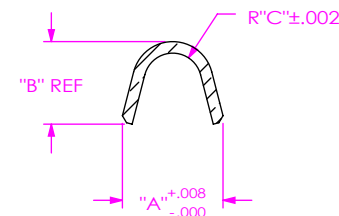
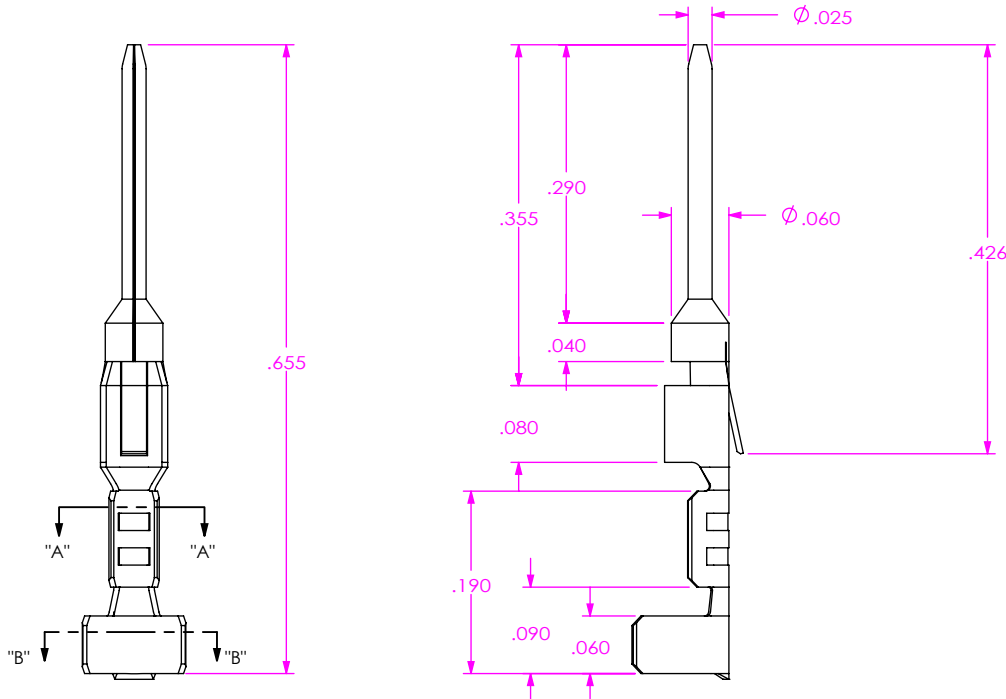

SECTION "A"-"A"
SCALE 10:1

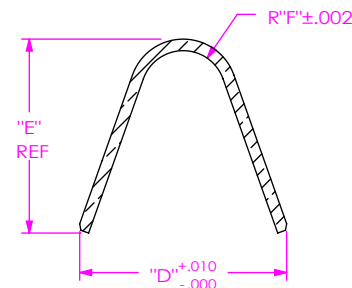

SECTION "B"-"B"
SCALE 10:1

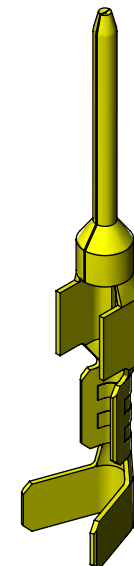

STYLE	"A"	"B"	"C"	"D"	"E"	"F"
-01	.052	.043	.015	.077	.071	.025
-02	.075	.065	.018	.108	.101	.030
-03	.052	.043	.015	.077	.055	.016

UNLESS OTHERWISE SPECIFIED, DIMENSIONS ARE IN INCHES.
TOLERANCES ARE:
DECIMALS ANGLES
.XX: $\pm .01$ 2°
.XXX: $\pm .005$
.XXXX: $\pm .0020$

PROPRIETARY NOTE
* THIS DOCUMENT CONTAINS CONFIDENTIAL AND PROPRIETARY INFORMATION AND ALL DESIGN, MANUFACTURING, REPRODUCTION, USE, PATENT RIGHTS AND SALES RIGHTS ARE EXPRESSLY RESERVED BY SAMTEC, INC. THIS DOCUMENT SHALL NOT BE DISCLOSED, IN WHOLE OR PART, TO ANY UNAUTHORIZED PERSON OR ENTITY NOR REPRODUCED, TRANSFERRED OR INCORPORATED IN ANY OTHER PROJECT IN ANY MANNER WITHOUT THE EXPRESS WRITTEN CONSENT OF SAMTEC, INC. *



520 PARK EAST BLVD, NEW ALBANY, IN 47150
PHONE: 812-944-6733 FAX: 812-948-5047
e-Mail: info@SAMTEC.com code: 55322

MATERIAL: DO NOT SCALE DRAWING SHEET SCALE: 2:1
PHOS BRONZE
THICKNESS: .0060 \pm .0003

DESCRIPTION:
.100" C.L. DISCRETE WIRE TERMINAL

DWG. NO. T1M74-X-XX-X

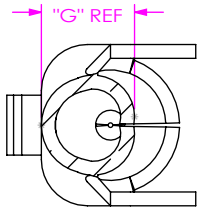

WIRE CRIMP
SCALE 16:1

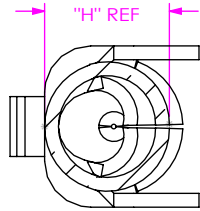

INSULATION CRIMP
SCALE 16:1

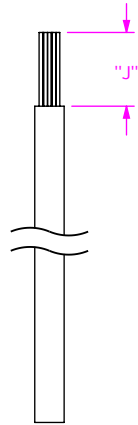

INSULATOR STRIP LENGTH

P/N	AWG	STRANDS / AWG	INSULATION OD	"G"	"H"	"J"	VESTIGE LENGTH	TAB LENGTH	PULL FORCE (LBS)
T-1M74-X-01-X	30	7/38	0.029-0.035	.0200	.045	.128	.0020	.0100	1.5
	28	7/36	0.032-0.038	.0210	.050	.128	.0020	.0100	2
	26	7/34	0.048-0.054	.0230	.055	.128	.0020	.0100	3
T-1M74-X-02-X	24	7/32	0.053-0.059	.0270	.070	.128	.0020	.0100	5
	24T	7/32	0.053-0.059	.0270	.075	.128	.0020	.0100	5
	22	7/30	0.059-0.065	.0310	.079	.128	.0020	.0100	8
	20	7/28	0.066-0.072	.0380	.083	.128	.0020	.0100	13
	20T	7/28	0.066-0.072	.0380	.076	.128	.0020	.0100	13
T-1M74-X-03-X	30T	7/36	0.029-0.035	.0200	.042	.128	.0020	.0100	1.5
	28T	7/36	0.032-0.038	.0220	.045	.128	.0020	.0100	2

REEL SPECIFICATIONS

PLATED T1M74 PARTS ARE TO BE UNWOUND THEN REWOUND AND COUNTED.
 15,300+100/-0 PCS POSITIONED AS SHOWN ON SAMTEC REEL WITH VIEWPORTS.
 LABELED T1M74 WITH APPROPRIATE PLATE CALL OUT AND LABEL PLACED AS SHOWN.
 MAXIMUM OF 2 SPLICES PER REEL, SPLICES ARE NOT TO BE CONNECTED.
 NUMBER OF SPLICES TO BE MARKED ON EACH REEL.
 REELED PARTS TO BE INTERLEAVED WITH PAPER BETWEEN EACH LAYER OF PARTS.
 SECURELY CONNECT INTERLEAF SPLICE.
 OUTER WRAP SHALL RECEIVE RB-24-1.00-P PROTECTIVE REEL BAND.

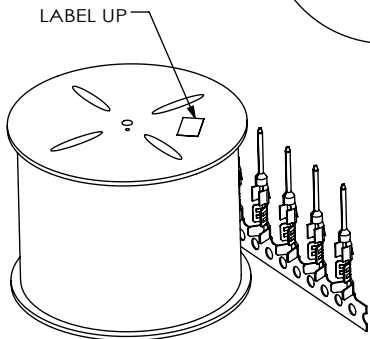
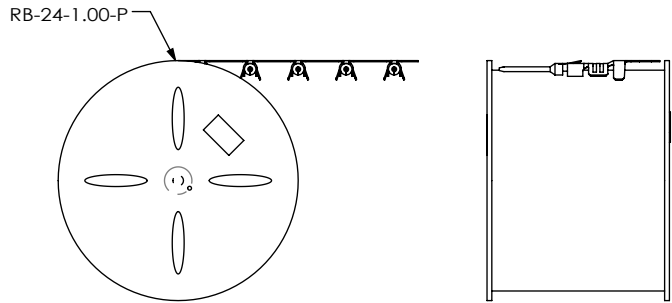

CARRIER SPECIFICATIONS

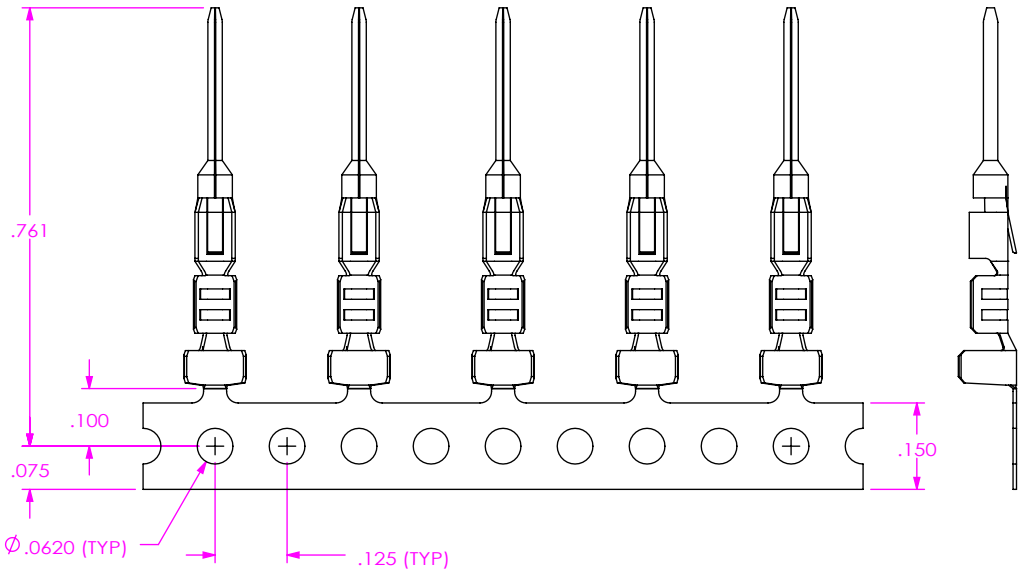

PROPRIETARY NOTE

THIS DOCUMENT CONTAINS CONFIDENTIAL AND PROPRIETARY INFORMATION AND ALL DESIGN, MANUFACTURING, REPRODUCTION, USE, PATENT RIGHTS AND SALES RIGHTS ARE EXPRESSLY RESERVED BY SAMTEC, INC. THIS DOCUMENT SHALL NOT BE DISCLOSED, IN WHOLE OR PART, TO ANY UNAUTHORIZED PERSON OR ENTITY NOR REPRODUCED, TRANSFERRED OR INCORPORATED IN ANY OTHER PROJECT IN ANY MANNER WITHOUT THE EXPRESS WRITTEN CONSENT OF SAMTEC, INC.

DO NOT SCALE DRAWING

SHEET SCALE: 4:1



520 PARK EAST BLVD, NEW ALBANY, IN 47150
 PHONE: 812-944-6733 FAX: 812-948-5047
 e-Mail: info@SAMTEC.com code: 55322

DESCRIPTION: .100" C.L. DISCRETE WIRE TERMINAL

DWG. NO. T1M74-X-XX-X

BY: VICKY Z 01/13/2010 SHEET 2 OF 2