

Data sheet | Item number: 885-106

Stud terminal block; lateral marker slots; for DIN-rail 35 x 15 and 35 x 7.5; 1 stud, M6; 35,00 mm²; gray

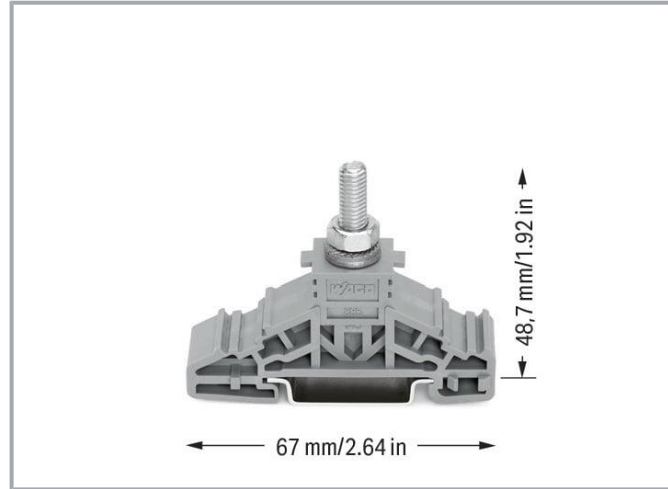

www.wago.com/885-106

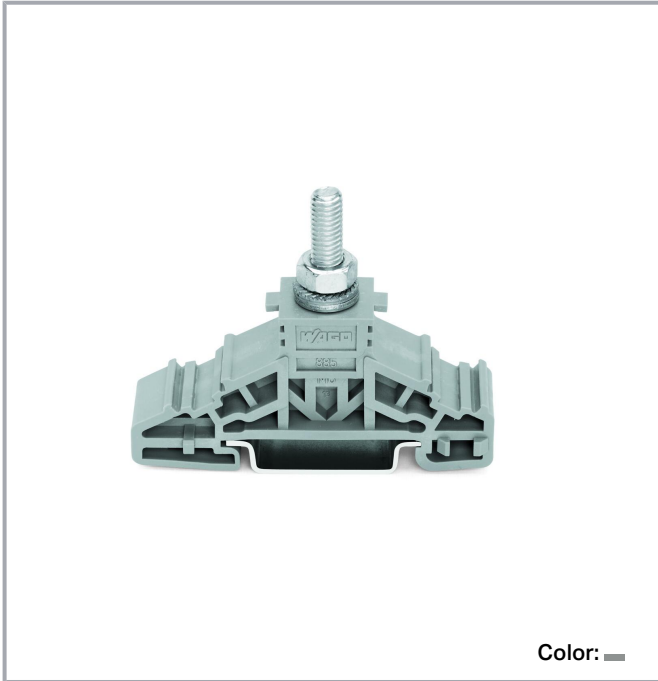

Data

Electrical data

Ratings per IEC/EN

Nominal voltage (III/3)	1000 V
Rated impulse voltage (III/3)	8 kV
Rated current	125 A
Legend (ratings)	(III / 3) ≙ Overvoltage category III / Pollution degree 3

Ratings per UL 1059

Approvals per	UL 1059
---------------	---------

Ratings per CSA

Approvals per	CSA 22.2 No 158
---------------	-----------------

Subject to changes. Please also observe the further product documentation!

WAGO GmbH & Co. KG
Hansastr. 27
32423 Minden
Phone: +49571 887-0 | Fax: +49571 887-169
Email: info.de@wago.com | Web: www.wago.com

Do you have any questions about our products?
We are always happy to take your call at +49 (571) 887-44222.

Power loss

Power loss, per pole (potential)	4.062 W
Rated current I_N for specified power loss	125 A
Resistance value for specified, current-dependent power loss	0 Ω

Connection data

Connection points	1
Total number of potentials	1
Number of levels	1

Connection 1

Connection technology	Bolt-type connection
Actuation type	Open-end, ring, socket wrench; 10 mm
Connectable conductor materials	Copper
Clamping range	2.5 ... 35 mm ² / 14 ... 2 AWG
Type of cable lugs per DIN 46234	Cable lugs for solder-free connections Ring type, without insulating sleeve, for copper conductors
Type of cable lugs per DIN 46235	Cable lugs for compression connections Cover plate type for copper conductors
Thread size	M6

Physical data

Width	17.8 mm / 0.701 inches
Height	67 mm / 2.638 inches
Depth from upper-edge of DIN-rail	48.7 mm / 1.917 inches

Mechanical Data

Tightening torque	3 ... 6 Nm
Mounting type	DIN-35 rail
Marking level	Side marking

Material Data

Note (material data)	Information on material specifications can be found here
Color	gray

Subject to changes. Please also observe the further product documentation!

Material group	I
Insulation material	Polyamide (PA66)
Flammability class per UL94	V0
Fire load	0.39 MJ
Weight	27.4 g

Environmental requirements

Processing temperature	-35 ... +85 °C
Continuous operating temperature	-60 ... +105 °C

Commercial data



Product Group	1 (Rail Mounted Terminal Blocks)
eCl@ss 10.0	27-14-11-20
eCl@ss 9.0	27-14-11-20
ETIM 8.0	EC000897
ETIM 7.0	EC000897
PU (SPU)	25 pcs
Packaging type	box
Country of origin	CN
GTIN	4050821049227
Customs tariff number	85369095000

Environmental Product Compliance

RoHS Compliance Status	Compliant, No Exemption
------------------------	-------------------------

Approvals / Certificates

General approvals

Logo	Approval	Additional Approval Text	Certificate name
	CCA DEKRA Certification B.V.	EN 60947	2145295.01
	CCA DEKRA Certification B.V.	EN 60947	NTR NL 6882
	CSA	C22.2 No. 158	70038960

Subject to changes. Please also observe the further product documentation!



DEKRA Certification B.V.





UL
UL International Germany GmbH

UL 1059

E45172

Declarations of conformity and manufacturer's declarations

Logo	Approval	Additional Approval Text	Certificate name
	EU-Declaration of Conformity WAGO GmbH & Co. KG	-	-
	UK-Declaration of Conformity WAGO GmbH & Co. KG	-	-

Optional accessories

Jumpers

Jumper



Item no.: 885-426
Jumper; 3-way; unplated; silver-colored

www.wago.com/885-426

Item no.: 885-448
Step-down jumper; M8 to M6; silver-colored

www.wago.com/885-448

Item no.: 885-470
Step-down jumper; M10 to M6; silver-colored

www.wago.com/885-470

Item no.: 885-406
Jumper; 2-way; unplated; silver-colored

www.wago.com/885-406

Marking accessories

Marking strip



Item no.: 2009-110
Marking strips; for Smart Printer; on reel; not stretchable; plain; snap-on type; white

www.wago.com/2009-110









Marker carrier



Item no.: 2009-198
Adaptor; gray

www.wago.com/2009-198

Subject to changes. Please also observe the further product documentation!

Marker		
	Item no.: 2009-115/000-002 WMB-Inline; for Smart Printer; 1500 pieces on roll; stretchable 5 - 5.2 mm; plain; snap-on type; yellow	www.wago.com/2009-115/000-002
	Item no.: 2009-115/000-007 WMB-Inline; for Smart Printer; 1500 pieces on roll; stretchable 5 - 5.2 mm; plain; snap-on type; gray	www.wago.com/2009-115/000-007
	Item no.: 2009-115/000-017 WMB-Inline; for Smart Printer; 1500 pieces on roll; stretchable 5 - 5.2 mm; plain; snap-on type; light green	www.wago.com/2009-115/000-017
	Item no.: 2009-115/000-023 WMB-Inline; for Smart Printer; 1500 pieces on roll; stretchable 5 - 5.2 mm; plain; snap-on type; green	www.wago.com/2009-115/000-023
	Item no.: 2009-115/000-024 WMB-Inline; for Smart Printer; 1500 pieces on roll; stretchable 5 - 5.2 mm; plain; snap-on type; violet	www.wago.com/2009-115/000-024
	Item no.: 2009-115 WMB-Inline; for Smart Printer; 1500 pieces on roll; stretchable 5 - 5.2 mm; plain; snap-on type; white	www.wago.com/2009-115
	Item no.: 793-5501/000-007 WMB marking card; as card; for terminal block width 5 - 17.5 mm; stretchable 5 - 5.2 mm; plain; snap-on type; gray	www.wago.com/793-5501/000-007
	Item no.: 793-5501/000-012 WMB marking card; as card; for terminal block width 5 - 17.5 mm; stretchable 5 - 5.2 mm; plain; snap-on type; orange	www.wago.com/793-5501/000-012
	Item no.: 793-5501/000-014 WMB marking card; as card; for terminal block width 5 - 17.5 mm; stretchable 5 - 5.2 mm; plain; snap-on type; brown	www.wago.com/793-5501/000-014
	Item no.: 793-5501/000-017 WMB marking card; as card; for terminal block width 5 - 17.5 mm; stretchable 5 - 5.2 mm; plain; snap-on type; light green	www.wago.com/793-5501/000-017
	Item no.: 793-5501/000-023 WMB marking card; as card; for terminal block width 5 - 17.5 mm; stretchable 5 - 5.2 mm; plain; snap-on type; green	www.wago.com/793-5501/000-023

Item no.: 793-5501/000-024

Subject to changes. Please also observe the further product documentation!



WMB marking card; as card; for terminal block width 5 - 17.5 mm; stretchable 5 - 5.2 mm; plain; snap-on type; violet www.wago.com/793-5501/000-024



Item no.: 793-501/000-002 www.wago.com/793-501/000-002
WMB marking card; as card; not stretchable; plain; snap-on type; yellow



Item no.: 793-501/000-007 www.wago.com/793-501/000-007
WMB marking card; as card; not stretchable; plain; snap-on type; gray



Item no.: 793-501/000-017 www.wago.com/793-501/000-017
WMB marking card; as card; not stretchable; plain; snap-on type; light green



Item no.: 793-501/000-012 www.wago.com/793-501/000-012
WMB marking card; as card; not stretchable; plain; snap-on type; orange



Item no.: 793-501/000-023 www.wago.com/793-501/000-023
WMB marking card; as card; not stretchable; plain; snap-on type; green



Item no.: 793-501/000-006 www.wago.com/793-501/000-006
WMB marking card; as card; not stretchable; plain; snap-on type; blue



Item no.: 793-501/000-005 www.wago.com/793-501/000-005
WMB marking card; as card; not stretchable; plain; snap-on type; red



Item no.: 793-501 www.wago.com/793-501
WMB marking card; as card; not stretchable; plain; snap-on type; white



Item no.: 793-501/000-024 www.wago.com/793-501/000-024
WMB marking card; as card; not stretchable; plain; snap-on type; violet



Item no.: 793-5501/000-005 www.wago.com/793-5501/000-005
WMB marking card; as card; for terminal block width 5 - 17.5 mm; stretchable 5 - 5.2 mm; plain; snap-on type; red

Subject to changes. Please also observe the further product documentation!



Item no.: 793-5501/000-002

WMB marking card; as card; for terminal block width 5 - 17.5 mm; stretchable 5 - 5.2 mm; plain; snap-on type; yellow www.wago.com/793-5501/000-002



Item no.: 793-5501/000-006

WMB marking card; as card; for terminal block width 5 - 17.5 mm; stretchable 5 - 5.2 mm; plain; snap-on type; blue www.wago.com/793-5501/000-006



Item no.: 793-5501

WMB marking card; as card; for terminal block width 5 - 17.5 mm; stretchable 5 - 5.2 mm; plain; snap-on type; white www.wago.com/793-5501



Item no.: 2009-115/000-012

WMB-Inline; for Smart Printer; 1500 pieces on roll; stretchable 5 - 5.2 mm; plain; snap-on type; orange www.wago.com/2009-115/000-012



Item no.: 2009-115/000-006

WMB-Inline; for Smart Printer; 1500 pieces on roll; stretchable 5 - 5.2 mm; plain; snap-on type; blue www.wago.com/2009-115/000-006

Mounting

Empty housings



Item no.: 885-506

Empty housing; M6; gray www.wago.com/885-506

Cover



Item no.: 885-566

Cover; 1 m long; transparent www.wago.com/885-566

Mounting accessories



Item no.: 249-117

Screwless end stop; 10 mm wide; for DIN-rail 35 x 15 and 35 x 7.5; gray www.wago.com/249-117



Item no.: 249-197

Screwless end stop; 14 mm wide; for DIN-rail 35 x 15 and 35 x 7.5; gray www.wago.com/249-197

End plate

End plate



Item no.: 885-546

Separator plate with jumper bar recess; 2 mm thick; 102.3 mm wide; gray www.wago.com/885-546



Item no.: 885-526

Separator plate; 2 mm thick; 102.3 mm wide; gray www.wago.com/885-526

Carrier rail

Mounting accessories

Subject to changes. Please also observe the further product documentation!

	Item no.: 210-197 Steel carrier rail; 35 x 15 mm; 1.5 mm thick; 2 m long; slotted; similar to EN 60715; silver-colored	www.wago.com/210-197
	Item no.: 210-198 Copper carrier rail; 35 x 15 mm; 2.3 mm thick; 2 m long; unslotted; according to EN 60715; copper-colored	www.wago.com/210-198
	Item no.: 210-504 Steel carrier rail; 35 x 7.5 mm; 1 mm thick; 2 m long; slotted; galvanized; according to EN 60715; silver-colored	www.wago.com/210-504
	Item no.: 210-505 Steel carrier rail; 35 x 7.5 mm; 1 mm thick; 2 m long; unslotted; galvanized; according to EN 60715; silver-colored	www.wago.com/210-505
	Item no.: 210-506 Steel carrier rail; 35 x 15 mm; 1.5 mm thick; 2 m long; unslotted; galvanized; similar to EN 60715; silver-colored	www.wago.com/210-506
	Item no.: 210-508 Steel carrier rail; 35 x 15 mm; 1.5 mm thick; 2 m long; slotted; galvanized; similar to EN 60715; silver-colored	www.wago.com/210-508
	Item no.: 210-113 Steel carrier rail; 35 x 7.5 mm; 1 mm thick; 2 m long; unslotted; according to EN 60715; silver-colored	www.wago.com/210-113
	Item no.: 210-118 Steel carrier rail; 35 x 15 mm; 2.3 mm thick; 2 m long; unslotted; according to EN 60715; silver-colored	www.wago.com/210-118
	Item no.: 210-112 Steel carrier rail; 35 x 7.5 mm; 1 mm thick; 2 m long; slotted; according to EN 60715; "Hole width 25 mm; silver-colored	www.wago.com/210-112
	Item no.: 210-114 Steel carrier rail; 35 x 15 mm; 1.5 mm thick; 2 m long; unslotted; similar to EN 60715; silver-colored	www.wago.com/210-114
	Item no.: 210-115 Steel carrier rail; 35 x 7.5 mm; 1 mm thick; 2 m long; slotted; according to EN 60715; "Hole width 18 mm; silver-colored	www.wago.com/210-115

Downloads

Documentation

Additional Information

Technical Section	pdf	Download
Technical explanations	2.2 MB	

CAD/CAE-Data

CAD data

Subject to changes. Please also observe the further product documentation!

WAGO GmbH & Co. KG
 Hansastr. 27
 32423 Minden
 Phone: +49571 887-0 | Fax: +49571 887-169
 Email: info.de@wago.com | Web: www.wago.com

Do you have any questions about our products?
 We are always happy to take your call at +49 (571) 887-44222.



2D/3D Models 885-106

[URL](#) [Download](#)

CAE data

EPLAN Data Portal 885-106

[URL](#) [Download](#)

WSCAD Universe 885-106

[URL](#) [Download](#)

ZUKEN Portal 885-106

[URL](#) [Download](#)

Environmental Product Compliance

Compliance Search

Environmental Product Compliance 885-106

[URL](#) [Download](#)

Stud terminal block; lateral marker slots; for DIN-rail 35 x 15 and 35 x 7.5; 1 stud, M6; 35,00 mm²; gray

Installation Notes

Subject to changes. Please also observe the further product documentation!