

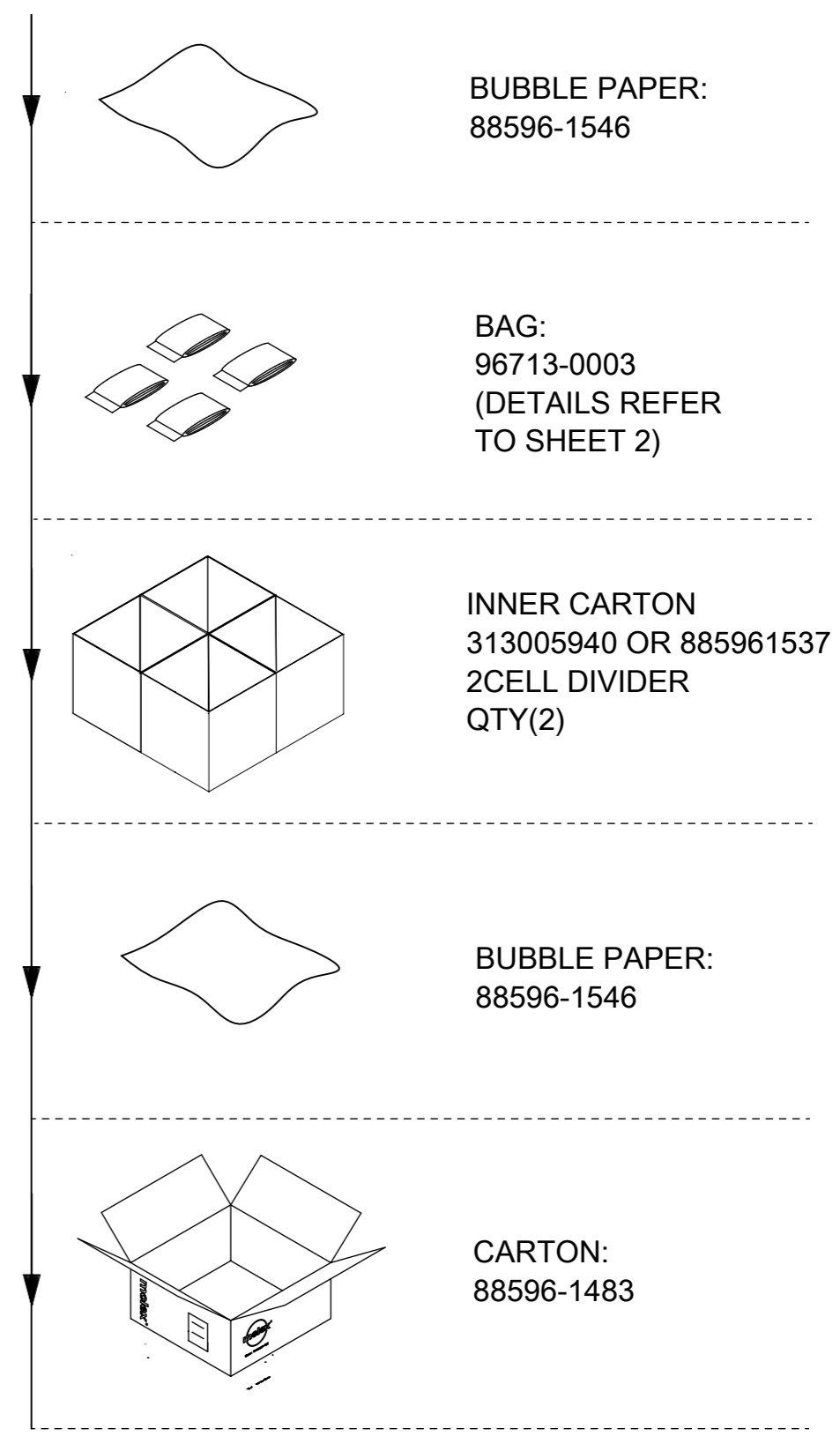

PART NUMBER	CKTS	QUANTITY PER BAG	BAGS PER CARTON	PARTS PER CARTON (SPQ)	MOISTURIZATION METHOD 	PANEL LOCK
215922-0201	2	3000	4	12000	NO MOISTURIZATION	WITHOUT
215922-0401	4	2600	4	10400		
215922-0601	6	2000	4	8000		
215922-0801	8	1700	4	6800		
215922-1001	10	1400	4	5600		
215922-1201	12	1000	4	4000		
215922-1401	14	800	4	3200		
215922-1601	16	800	4	3200		
215922-1801	18	600	4	2400		
215922-2001	20	600	4	2400		
215922-2201	22	600	4	2400		
215922-2401	24	450	4	1800		
215922-0200	2	2000	4	8000	SEE SHEET 2	WITH
215922-0400	4	1800	4	7200		
215922-0600	6	1600	4	6400		
215922-0800	8	1100	4	4400		
215922-1000	10	1000	4	4000		
215922-1200	12	900	4	3600		
215922-1400	14	800	4	3200		
215922-1600	16	700	4	2800		
215922-1800	18	600	4	2400		
215922-2000	20	600	4	2400		
215922-2200	22	400	4	1600		
215922-2400	24	350	4	1400		



TBD: NO PRODUCTION, TO BE ADDED AFTER BEING PRODUCED.

- NOTES:
-  MOISTURIZATION METHOD DESCRIPTIONS REFER TO SHEET 2.
 - STANDARD PACKAGE QUANTITY (SPQ) SEE ABOVE CHART.
 - PACKAGE WAY FOLLOW RIGHT ILLUSTRATION.
 - ALL PACKAGE MATERIAL AND PRODUCT COMPLIANT TO RoHS DIRECTIVE 2011/65/EU AND ELV DIRECTIVE 2000/53/EC.

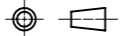
FUNCTIONAL SYMBOLS	THIS DRAWING CONTAINS INFORMATION THAT IS PROPRIETARY TO MOLEX ELECTRONIC TECHNOLOGIES, LLC AND SHOULD NOT BE USED WITHOUT WRITTEN PERMISSION		CURRENT REV DESC:			molex							
	mm	1:1											
DIVISIONAL SYMBOLS	GENERAL TOLERANCES (UNLESS SPECIFIED)		EC NO: 725570 DRWN: GLLI 2022/08/29 CHK'D: XQZHANG 2022/10/31 APPR: XQZHANG 2022/10/31			PACKING SPEC FOR MICRO-FIT PLUS WTW HSG							
	ANGULAR TOL ± °												
	4 PLACES	±				INITIAL REVISION: DRWN: GLLI 2021/10/28 APPR: XQZHANG 2021/11/15			DOCUMENT NUMBER		DOC TYPE	DOC PART	REVISION
	3 PLACES	± 0.1							2159220000-PK		PSD	000	B
	2 PLACES	± 0.3							MATERIAL NUMBER		CUSTOMER		SHEET NUMBER
1 PLACE	± 0.5	DRAFT WHERE APPLICABLE MUST REMAIN WITHIN DIMENSIONS		THIRD ANGLE PROJECTION	DRAWING	SERIES							
0 PLACES	±				A3-SIZE	215922							

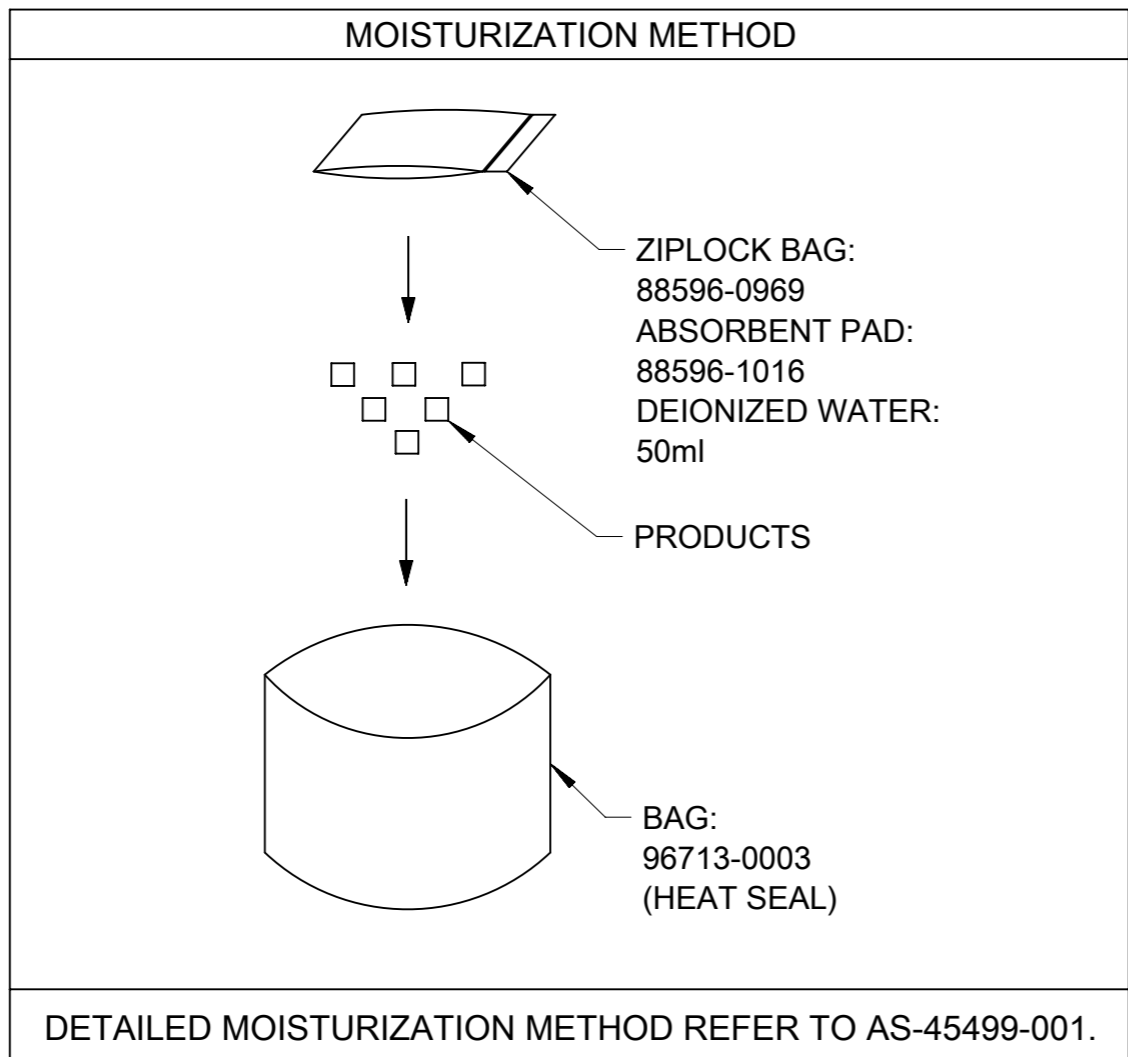

THIS DRAWING CONTAINS INFORMATION THAT IS PROPRIETARY TO MOLEX ELECTRONIC TECHNOLOGIES, LLC AND SHOULD NOT BE USED WITHOUT WRITTEN PERMISSION																	
FUNCTIONAL SYMBOLS	△/A = 0	mm	SCALE 1:1	CURRENT REV DESC:			molex										
	△/E = 0	GENERAL TOLERANCES (UNLESS SPECIFIED)									EC NO: 725570 DRWN: GLLI 2022/08/29 CHK'D: XQZHANG APPR: XQZHANG 2022/10/31			PACKING SPEC FOR MICRO-FIT PLUS WTW HSG			
	△/P = 0	ANGULAR TOL ± °															
DIVISIONAL SYMBOLS	4 PLACES	±	0.1	INITIAL REVISION: DRWN: GLLI 2021/10/28 APPR: XQZHANG 2021/11/15			DOCUMENT NUMBER		DOC TYPE	DOC PART	REVISION						
	3 PLACES	±	0.1				2159220000-PK		PSD	000	B						
	2 PLACES	±	0.3				MATERIAL NUMBER		CUSTOMER		SHEET NUMBER						
	1 PLACE	±	0.5				A3-SIZE 215922				2 OF 2						
	0 PLACES	±					DRAFT WHERE APPLICABLE MUST REMAIN WITHIN DIMENSIONS		THIRD ANGLE PROJECTION								

FREE HANGING PLUG PARTS

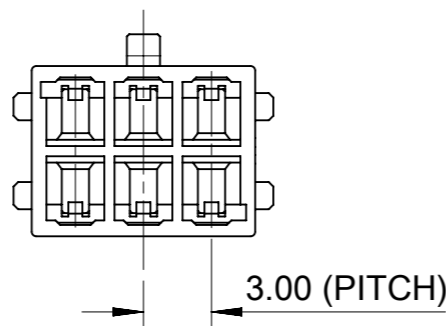
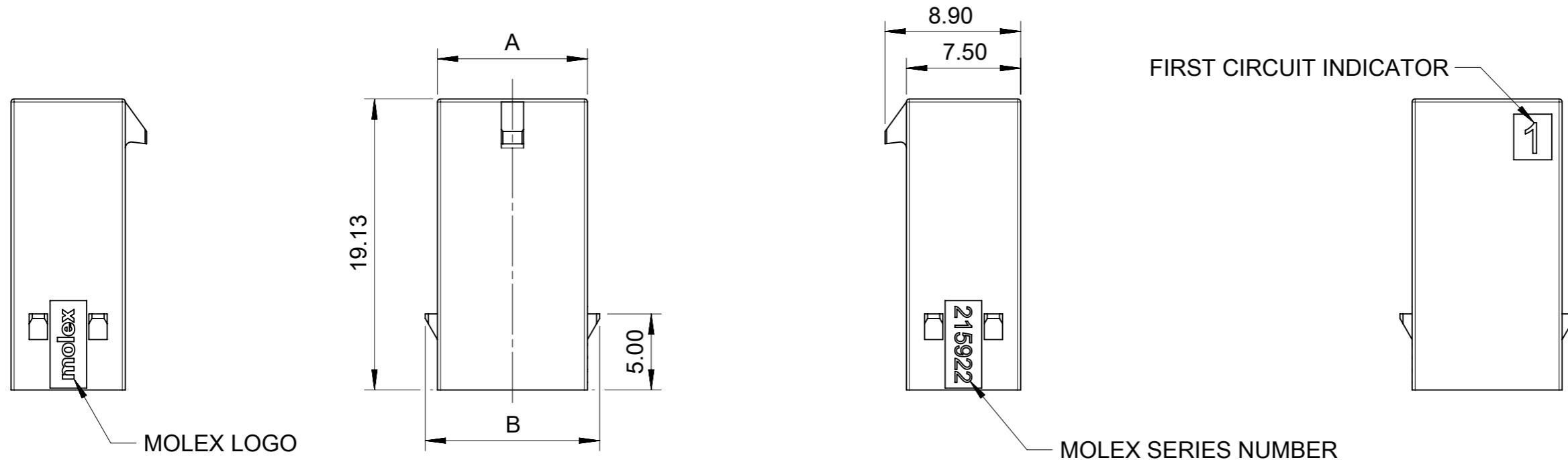

PART No	DIM'A'	DIM'B'	CKT SIZE
215922-0201	3.85	5.45	2
215922-0401	6.85	8.45	4
215922-0601	9.85	11.45	6
215922-0801	12.85	14.45	8
215922-1001	15.85	17.45	10
215922-1201	18.85	20.45	12
215922-1401	21.85	23.45	14
215922-1601	24.85	26.45	16
215922-1801	27.85	29.45	18
215922-2001	30.85	32.45	20
215922-2201	33.85	35.45	22
215922-2401	36.85	38.45	24

- NOTES:
1. MATERIAL: PA66, 94V-0, BLACK.
 2. PRODUCT SPECIFICATION: 2159530000-PS.
 3. PACKAGE SPECIFICATION: 2159220000-PK.
 4. TO USE WITH TERMINAL OF 2015953-****.
 5. TO USE WITH TPA OF 206462-****.
 6. TO MATE WITH RECEPTACLE OF 206461-****.
 7. PARTS CONFORM TO CLASS 'B' REQUIREMENTS OF COSMETIC SPECIFICATION PS-45499-002.

FUNCTIONAL SYMBOLS	THIS DRAWING CONTAINS INFORMATION THAT IS PROPRIETARY TO MOLEX ELECTRONIC TECHNOLOGIES, LLC AND SHOULD NOT BE USED WITHOUT WRITTEN PERMISSION		CURRENT REV DESC:					
	DIMENSION UNITS	SCALE						
$\nabla_A = 0$	mm	1:1	EC NO: 712744		PRODUCT CUSTOMER DRAWING			
$\nabla_E = 0$	GENERAL TOLERANCES (UNLESS SPECIFIED)		DRWN: GLLI 2022/07/01					
$\nabla_{E'} = 0$	ANGULAR TOL ± °		CHK'D: XQZHANG 2022/07/05		DOCUMENT NUMBER: 2159220000-SD DOC TYPE: PSD DOC PART: 000 REVISION: A1			
DIVISIONAL SYMBOLS	4 PLACES ±		APPR: XQZHANG 2022/07/05					
	3 PLACES ±		INITIAL REVISION:		MATERIAL NUMBER: 215922 CUSTOMER: GENERAL MARKET SHEET NUMBER: 1 OF 6			
	2 PLACES ± 0.2		DRWN: GLLI 2021/01/29					
	1 PLACE ± 0.3		APPR: XQZHANG 2021/11/15					
	0 PLACES ±		DRAFT WHERE APPLICABLE MUST REMAIN WITHIN DIMENSIONS					
	THIRD ANGLE PROJECTION		DRAWING: A3-SIZE					

FREE HANGING PLUG PARTS

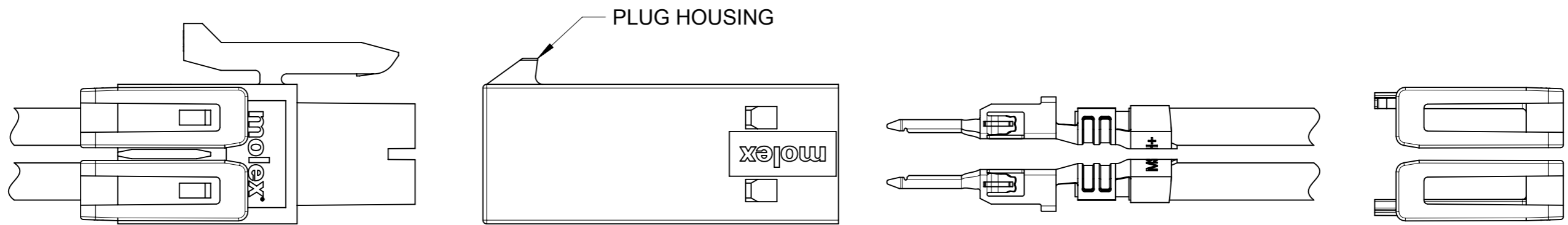
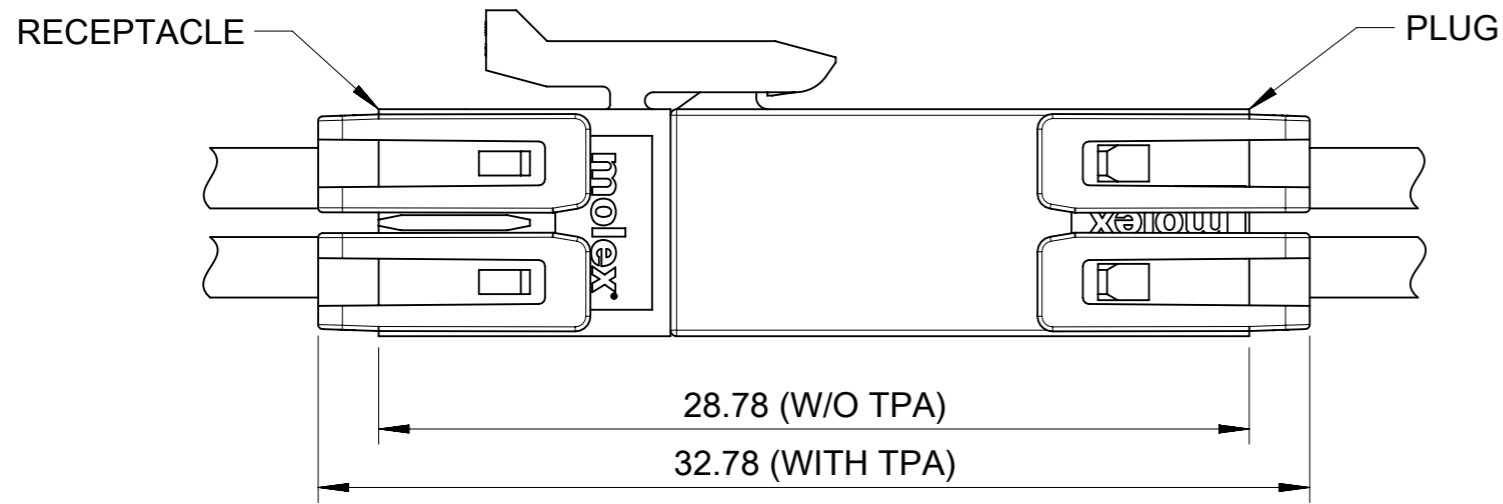

FUNCTIONAL SYMBOLS	THIS DRAWING CONTAINS INFORMATION THAT IS PROPRIETARY TO MOLEX ELECTRONIC TECHNOLOGIES, LLC AND SHOULD NOT BE USED WITHOUT WRITTEN PERMISSION		CURRENT REV DESC:		molex				
	△/A = 0	mm						SCALE 1:1	
DIVISIONAL SYMBOLS	GENERAL TOLERANCES (UNLESS SPECIFIED)		EC NO: 712744 DRWN: GLLI 2022/07/01 CHK'D: XQZHANG 2022/07/05 APPR: XQZHANG 2022/07/05		PLUG HOUSING OF MICRO-FIT PLUS WTW DR POWER CONNECTOR				
	ANGULAR TOL ± °				PRODUCT CUSTOMER DRAWING				
	4 PLACES ±				DOCUMENT NUMBER		DOC TYPE	DOC PART	REVISION
	3 PLACES ±				2159220000-SD		PSD	000	A1
	2 PLACES ± 0.2				MATERIAL NUMBER		CUSTOMER		
1 PLACE ± 0.3		215922		GENERAL MARKET					
0 PLACES ±		SERIES		SHEET NUMBER					
DRAFT WHERE APPLICABLE MUST REMAIN WITHIN DIMENSIONS		THIRD ANGLE PROJECTION	DRAWING	SERIES	SHEET NUMBER				
		⊕	A3-SIZE	215922	2 OF 6				

FREE HANGING PLUG PARTS

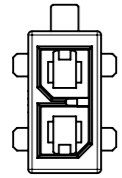

2 CKT

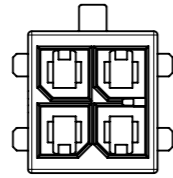

4 CKT

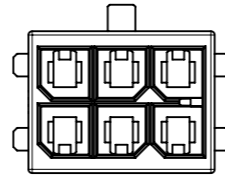

6 CKT

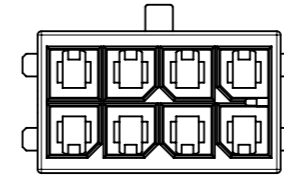

8 CKT

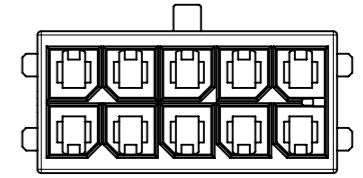

10 CKT

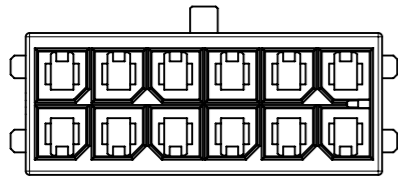

12 CKT

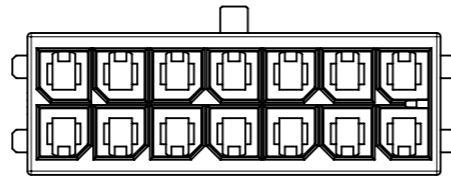

14 CKT

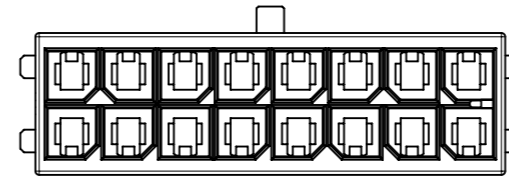

16 CKT

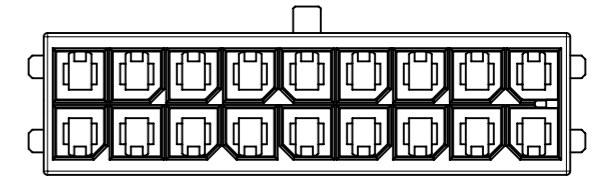

18 CKT

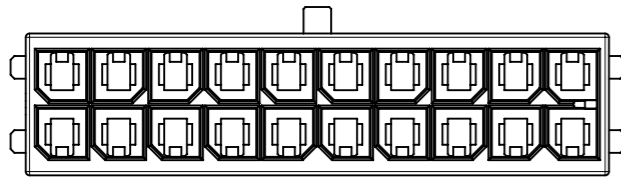

20 CKT

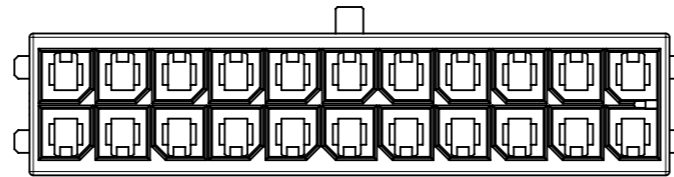

22 CKT

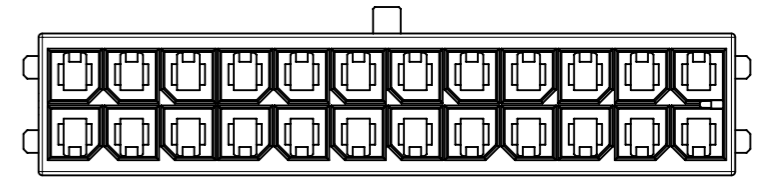

24 CKT

FUNCTIONAL SYMBOLS ▽A = 0 ▽E = 0 ▽V = 0	THIS DRAWING CONTAINS INFORMATION THAT IS PROPRIETARY TO MOLEX ELECTRONIC TECHNOLOGIES, LLC AND SHOULD NOT BE USED WITHOUT WRITTEN PERMISSION		CURRENT REV DESC:										
	mm	1:1									PLUG HOUSING OF MICRO-FIT PLUS WTW DR POWER CONNECTOR		
	GENERAL TOLERANCES (UNLESS SPECIFIED)		EC NO: 712744				PRODUCT CUSTOMER DRAWING						
	ANGULAR TOL ± °		DRWN: GLLI 2022/07/01				DOCUMENT NUMBER						
4 PLACES ±		CHK'D: XQZHANG 2022/07/05				2159220000-SD							
3 PLACES ±		APPR: XQZHANG 2022/07/05				DOC TYPE							
2 PLACES ± 0.2		INITIAL REVISION:				DOC PART							
1 PLACE ± 0.3		DRWN: GLLI 2021/01/29				REVISION							
0 PLACES ±		APPR: XQZHANG 2021/11/15				A1							
DRAFT WHERE APPLICABLE MUST REMAIN WITHIN DIMENSIONS		THIRD ANGLE PROJECTION		DRAWING		SERIES		MATERIAL NUMBER		CUSTOMER		SHEET NUMBER	
				A3-SIZE		215922		GENERAL MARKET		3 OF 6			

PANEL MOUNT PLUG PARTS

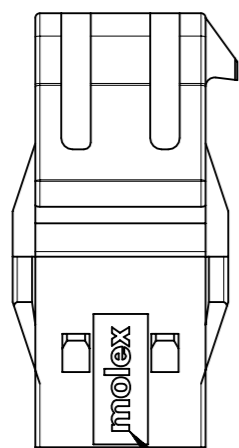

MOLEX LOGO

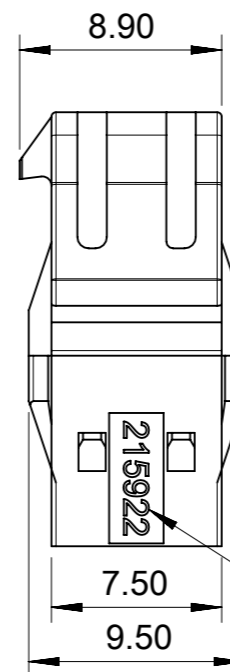
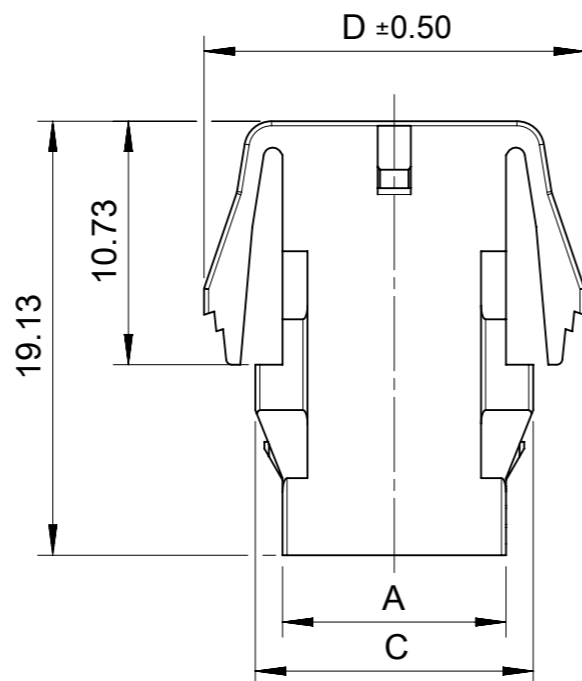

FIRST CIRCUIT INDICATOR

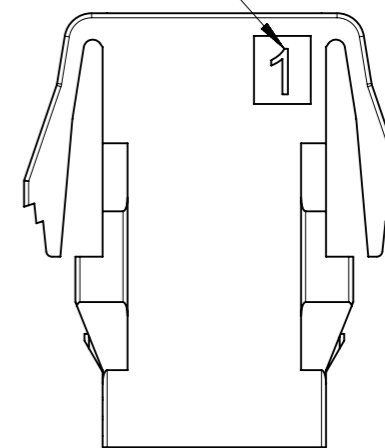

MOLEX SERIES NUMBER

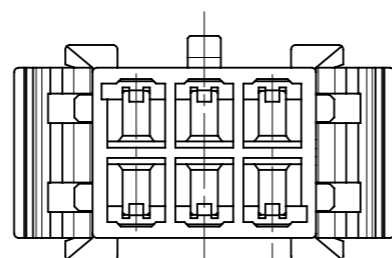

3.00 (PITCH)

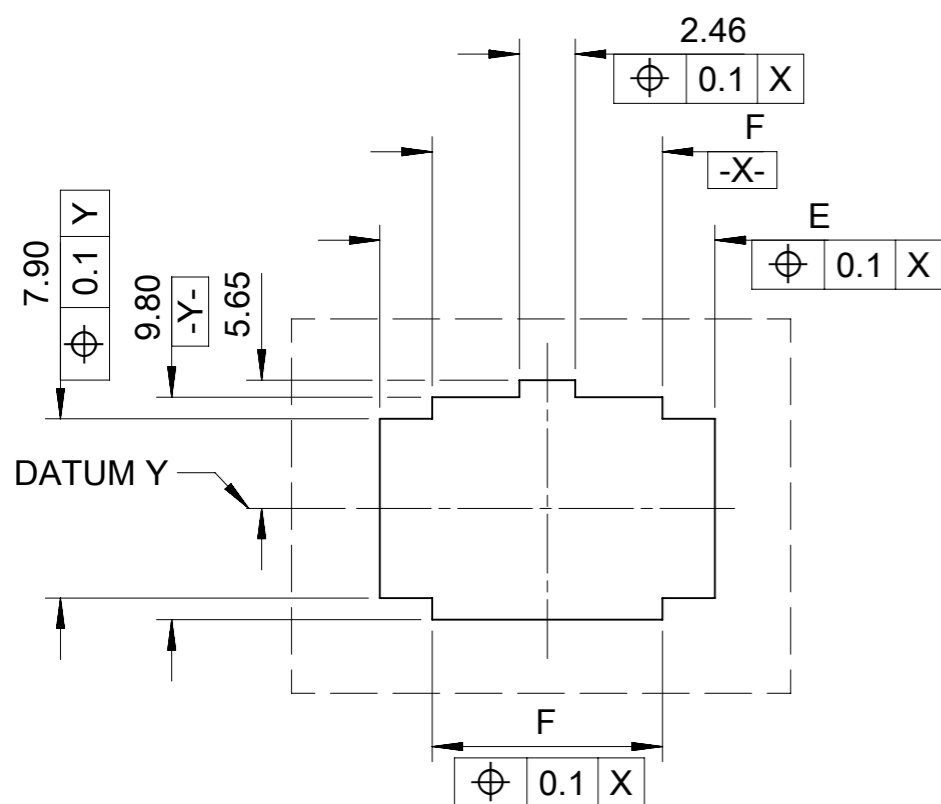

PART No	DIM 'A'	DIM 'C'	DIM 'D'	DIM 'E'	DIM 'F'	CKT SIZE
215922-0200	3.85	6.25	10.77	8.77	4.15	2
215922-0400	6.85	9.25	13.77	11.77	7.15	4
215922-0600	9.85	12.25	16.77	14.77	10.15	6
215922-0800	12.85	15.25	19.77	17.77	13.15	8
215922-1000	15.85	18.25	22.77	20.77	16.15	10
215922-1200	18.85	21.25	25.77	23.77	19.15	12
215922-1400	21.85	24.25	28.77	26.77	22.15	14
215922-1600	24.85	27.25	31.77	29.77	25.15	16
215922-1800	27.85	30.25	34.77	32.77	28.15	18
215922-2000	30.85	33.25	37.77	35.77	31.15	20
215922-2200	33.85	36.25	40.77	38.77	34.15	22
215922-2400	36.85	39.25	43.77	41.77	37.15	24

RECOMMENDED PANEL CUT OUT
(TOLERRANCE +/-0.05 THICKNESS=1.2~2.2MM)

FUNCTIONAL SYMBOLS	THIS DRAWING CONTAINS INFORMATION THAT IS PROPRIETARY TO MOLEX ELECTRONIC TECHNOLOGIES, LLC AND SHOULD NOT BE USED WITHOUT WRITTEN PERMISSION	CURRENT REV DESC:		molex
	DIMENSION UNITS: mm SCALE: 1:1 GENERAL TOLERANCES (UNLESS SPECIFIED) ANGULAR TOL ± ° 4 PLACES ± 3 PLACES ± 2 PLACES ± 0.2 1 PLACE ± 0.3 0 PLACES ±	EC NO: 712744 DRWN: GLLI 2022/07/01 CHK'D: XQZHANG 2022/07/05 APPR: XQZHANG 2022/07/05		
DIVISIONAL SYMBOLS	DRAFT WHERE APPLICABLE MUST REMAIN WITHIN DIMENSIONS	THIRD ANGLE PROJECTION	DRAWING	PRODUCT CUSTOMER DRAWING
			SERIES	DOCUMENT NUMBER
			215922	2159220000-SD
				DOC TYPE
				PSD
				DOC PART
				000
				REVISION
				A1
				MATERIAL NUMBER
				GENERAL MARKET
				CUSTOMER
				SHEET NUMBER
				4 OF 6

PANEL MOUNT PLUG PARTS

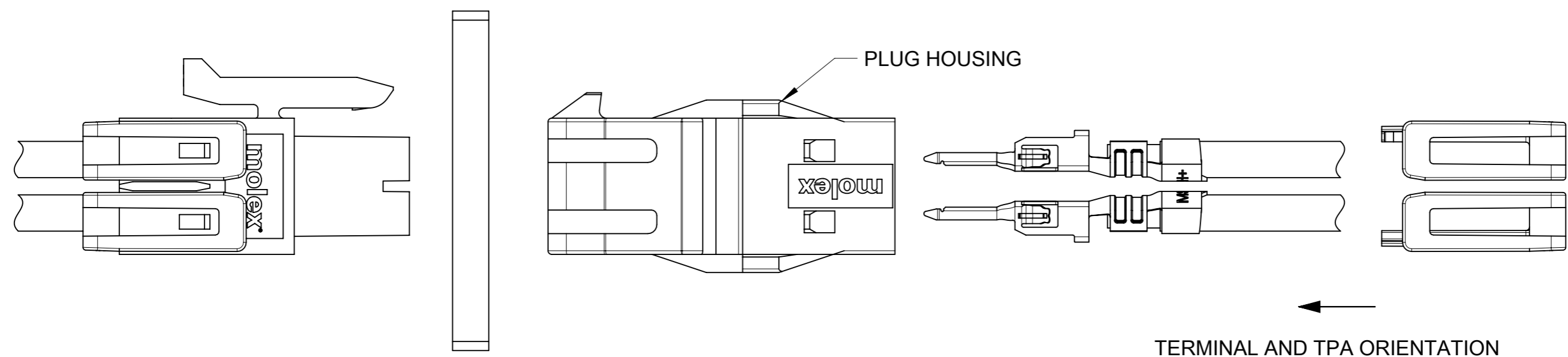
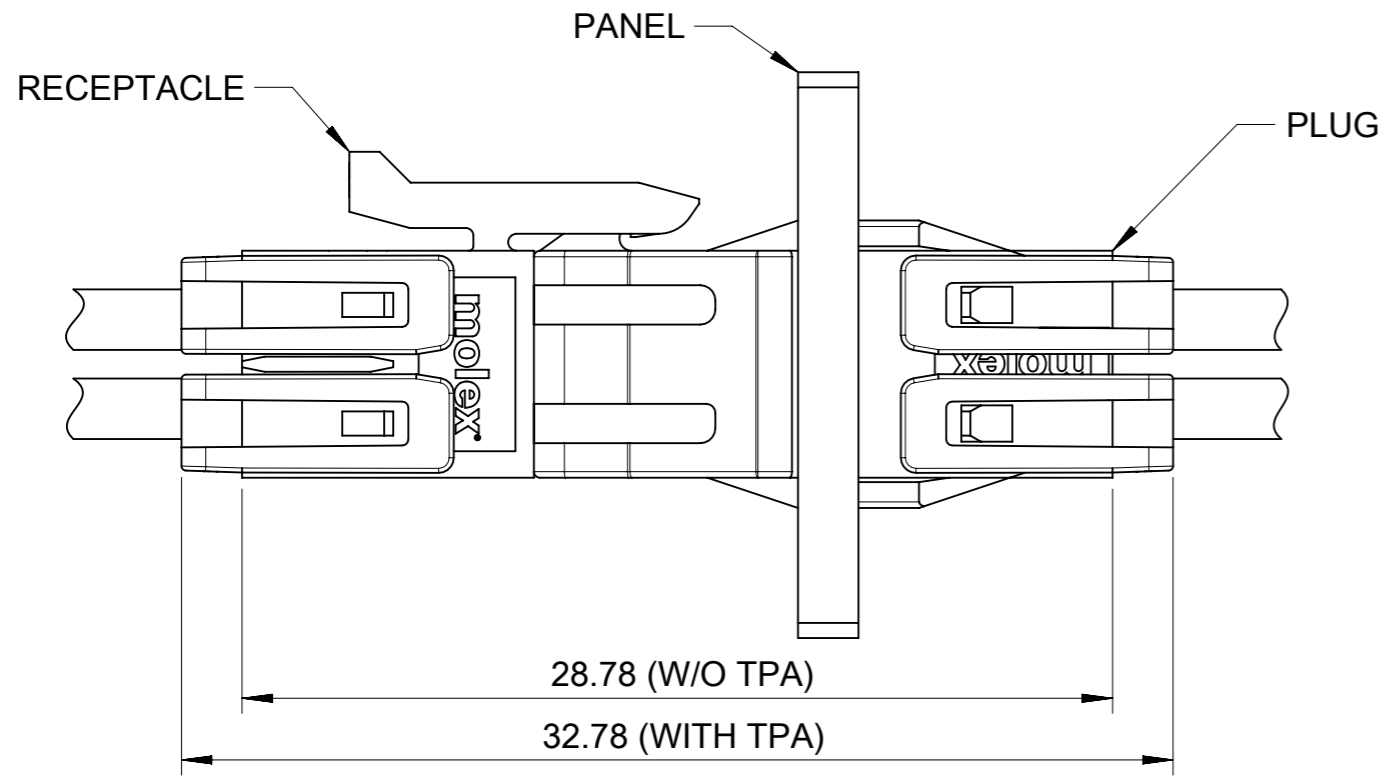

FUNCTIONAL SYMBOLS	THIS DRAWING CONTAINS INFORMATION THAT IS PROPRIETARY TO MOLEX ELECTRONIC TECHNOLOGIES, LLC AND SHOULD NOT BE USED WITHOUT WRITTEN PERMISSION		<div style="text-align: center; font-size: 24pt; font-weight: bold;">molex</div>										
	$\nabla_A = 0$ $\nabla_F = 0$ $\nabla_V = 0$	DIMENSION UNITS: mm SCALE: 1:1					CURRENT REV DESC:		PLUG HOUSING OF MICRO-FIT PLUS WTW DR POWER CONNECTOR				
DIVISIONAL SYMBOLS	GENERAL TOLERANCES (UNLESS SPECIFIED)		EC NO: 712744		2022/07/01								
	ANGULAR TOL ± °		DRWN: GLLI		2022/07/05								
	4 PLACES ±		CHK'D: XQZHANG		2022/07/05								
	2 PLACES ± 0.2		APPR: XQZHANG		2022/07/05								
	1 PLACE ± 0.3		INITIAL REVISION:										
0 PLACES ±		DRWN: GLLI		2021/01/29									
DRAFT WHERE APPLICABLE MUST REMAIN WITHIN DIMENSIONS		THIRD ANGLE PROJECTION		DRAWING		SERIES		MATERIAL NUMBER		CUSTOMER		SHEET NUMBER	
				A3-SIZE		215922		2159220000-SD		GENERAL MARKET		5 OF 6	

PANEL MOUNT PLUG PARTS

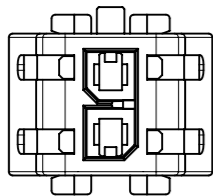

2 CKT

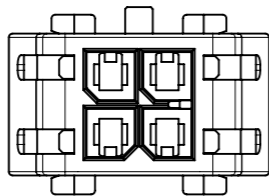

4 CKT

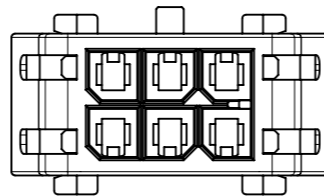

6 CKT

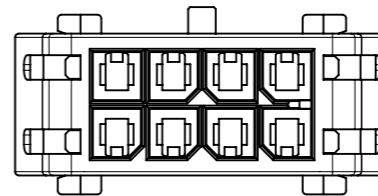

8 CKT

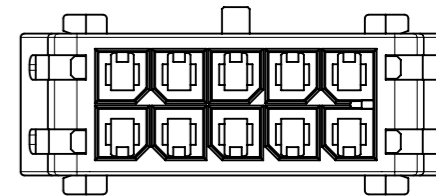

10 CKT

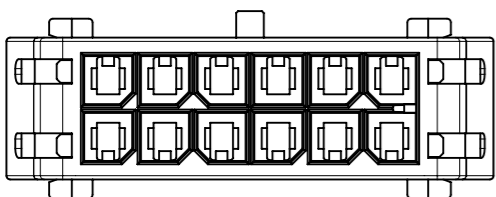

12 CKT

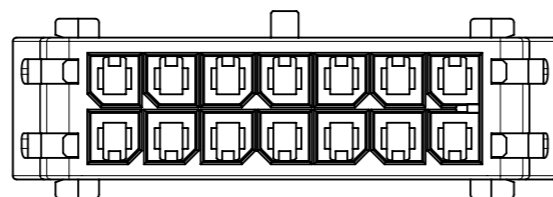

14 CKT

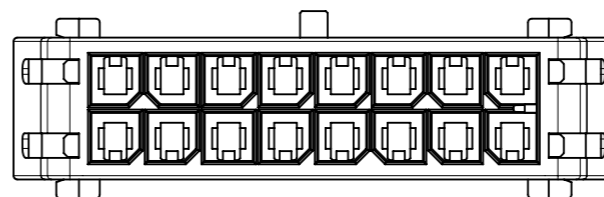

16 CKT

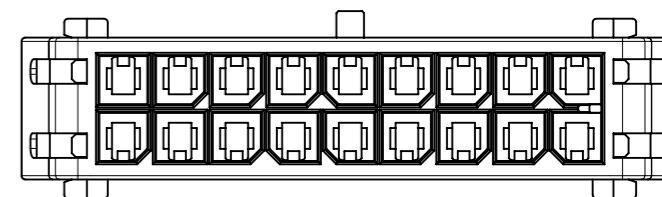

18 CKT

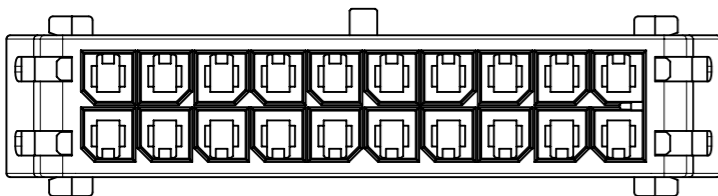

20 CKT

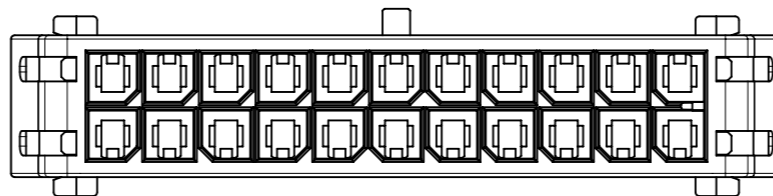

22 CKT

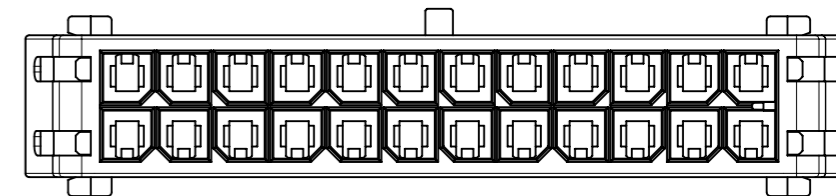

24 CKT

FUNCTIONAL SYMBOLS	THIS DRAWING CONTAINS INFORMATION THAT IS PROPRIETARY TO MOLEX ELECTRONIC TECHNOLOGIES, LLC AND SHOULD NOT BE USED WITHOUT WRITTEN PERMISSION		<div style="text-align: center; font-weight: bold; font-size: 1.2em;">molex</div> <p>PLUG HOUSING OF MICRO-FIT PLUS WTW DR POWER CONNECTOR</p>				
	$\nabla_A = 0$ $\nabla_E = 0$ $\nabla_V = 0$	DIMENSION UNITS: mm SCALE: 1:1 GENERAL TOLERANCES (UNLESS SPECIFIED) ANGULAR TOL ± ° 4 PLACES ± 3 PLACES ± 2 PLACES ± 0.2 1 PLACE ± 0.3 0 PLACES ±					CURRENT REV DESC: EC NO: 712744 DRWN: GLLI APPR: XQZHANG INITIAL REVISION: DRWN: GLLI APPR: XQZHANG
DIVISIONAL SYMBOLS	DRAFT WHERE APPLICABLE MUST REMAIN WITHIN DIMENSIONS	THIRD ANGLE PROJECTION 	DRAWING A3-SIZE	SERIES 215922	MATERIAL NUMBER CUSTOMER GENERAL MARKET	SHEET NUMBER 6 OF 6	