

Data sheet | Item number: 890-824

Socket for PCBs; straight; 4-pole; Cod. A; white

[www.wago.com/890-824](http://www.wago.com/890-824)

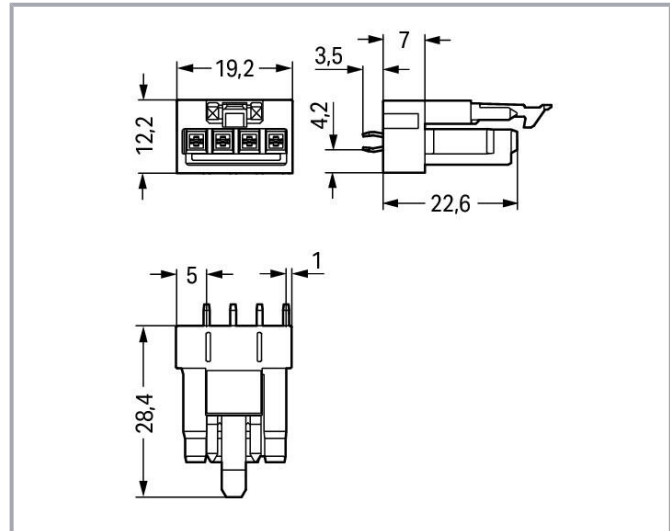
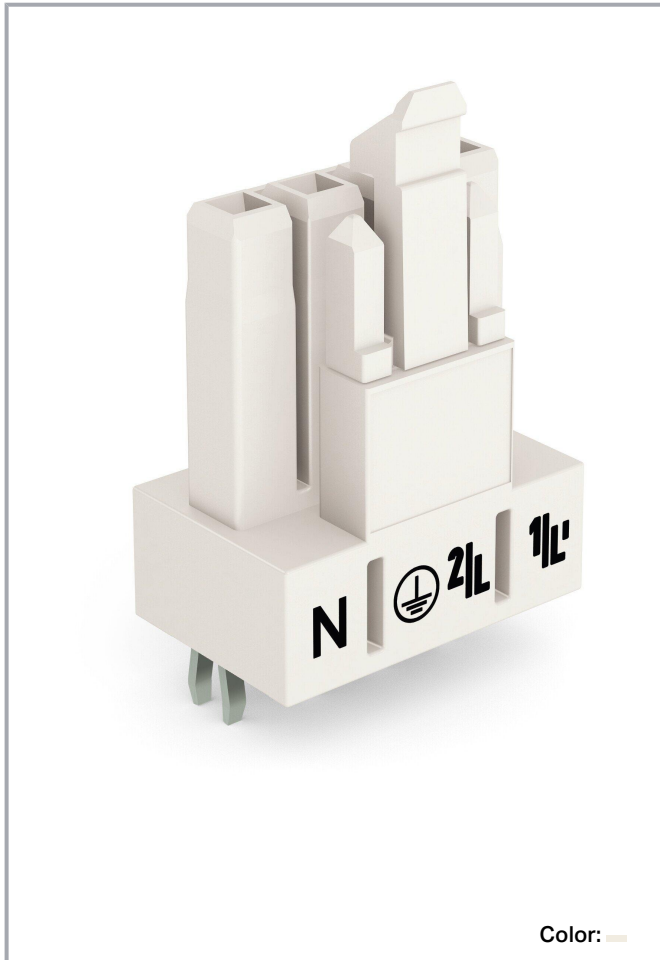

Subject to changes. Please also observe the further product documentation!

WAGO GmbH & Co. KG  
Hansastr. 27  
32423 Minden  
Phone: +49571 887-0 | Fax: +49571 887-169  
Email: [info.de@wago.com](mailto:info.de@wago.com) | Web: [www.wago.com](http://www.wago.com)

Do you have any questions about our products?  
We are always happy to take your call at +49 (571) 887-44222.

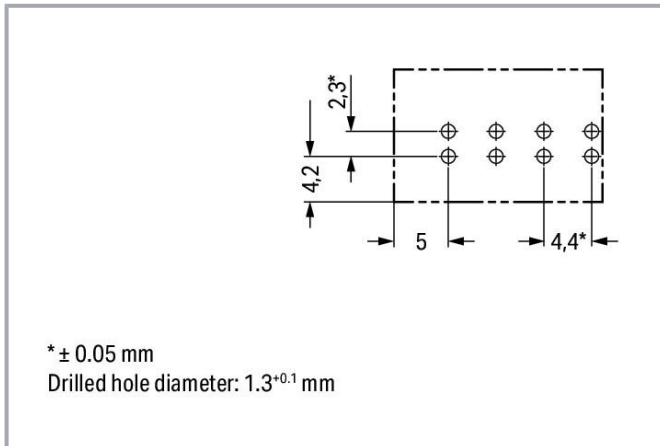

## Item description

### Female connector/socket WINSTA® MINI rated current 16 A

The WINSTA® MINI female connector/socket rated current 16 A saves space and money and space thanks to its compact dimensions. The pluggable PCB connectors with spring pressure connection technology and Push-in CAGE CLAMP® technology from WAGO permit impact-resistant, maintenance-free, fast terminal connections. The color coding and mechanical coding of the pcb connector ensure error-free installation of the individual components – including protection against mismatching. The WINSTA® MINI pcb connector with A coding in white or black is normally used for general mains applications in power distribution. WINSTA® MINI satisfies the demand for miniaturisation. Our smallest pluggable connection system is very good for lights, for instance, since as a result of LED technology; due to complex systems, these offer significantly less space for the connection technology.

### Push-in CAGE CLAMP® spring pressure connection technology – pluggable installation instead of laborious screw connections!

The WINSTA® Pluggable Connection System allows pluggable electrical installation. This saves time, lowers costs, and reduces the need for servicing. Now you can also reduce installation costs without compromising safety and quality: The WINSTA® MINI pcb connector with marking eliminates the need for servicing and prevents unnecessary downtime.

- 
- pcb connector with protection against mismatching
- consistent IP40 protection
- for any mains application
- fast, secure installation

Subject to changes. Please also observe the further product documentation!



## Data

### Electrical data

#### Ratings per IEC/EN

Ratings per	IEC/EN 60664-1
Nominal voltage (III/3)	250 V
Rated impulse voltage (III/3)	4 kV
Rated current	16 A
Legend (ratings)	(III / 3) $\hat{=}$ Overvoltage category III / Pollution degree 3

#### Ratings per UL 1977

Note for the US market	Some versions may also be used for current interruption in accordance with the UL certificate in select applications with currents below 5 A and voltages up to 600 V. For further information, please contact your local sales office.
Rated voltage (UL 1977)	600 V
Rated current UL 1977	12 A

### General

Note on contact resistance	approx. 1 m $\Omega$ of contact resistance approx. 0.25 m $\Omega$ contact transition plug/socket
----------------------------	--

### Connection data

Total number of potentials	4
Number of levels	1

### Connection 1

Pole number	4
-------------	---

### Physical data

Pin spacing	4.4 mm / 0.173 inches
Width	19.2 mm / 0.756 inches
Height	31.9 mm / 1.256 inches
Height from the surface	28.4 mm / 1.118 inches
Depth	12.2 mm / 0.48 inches
Solder pin length	3.5 mm
Solder pin dimensions	1 x 0.8 mm

Subject to changes. Please also observe the further product documentation!

Drilled hole diameter with tolerance	1.3 <sup>(+0.1)</sup> mm
--------------------------------------	--------------------------

## Mechanical Data

Application	General mains applications
Coding	A
Variable coding	No
Marking	N $\frac{2}{L}$ 1/L'
Potential marking	N $\frac{2}{L}$ 1/L'
Mating force of a plug-in connection	approx. 20 ... 70 N (depending on pole number)
Retention force of a plug-in connection	Locked: > 80 N
Unmating force of a plug-in connection	Unlocked: approx. 20 ... 70 N (depending on pole number)
Number of mating cycles	200, without resistive load
Design	straight

## Plug-in connection

Contact type (pluggable connector)	Female connector/socket
Connector (connection type)	for PCB
Mismating protection	Yes
Note on mismating protection	All WINSTA <sup>®</sup> components are 100% protected against mismating when: a.) plugging different numbers of poles b.) plugging while rotated 180 c.) plugging while laterally staggered d.) plugging one pole
Mating direction to the PCB	90 °
Locking lever	yes
Locking of plug-in connection	locking lever
Note on locking system	All connectors for mounted installations (snap-in versions for lighting fixtures or devices, all types of PCB and distribution connectors) are factory-equipped with locking levers to ensure plugs and sockets are securely locked. Additional locking levers are only required for flying leads (plug/socket).

## PCB contact

PCB contact	THT
Solder pin arrangement	2 in-line solder pins/pole
Number of solder pins per potential	2

Subject to changes. Please also observe the further product documentation!



## Material Data

Note (material data)

Information on material specifications can be found here

Color	white
Cover color	gray
Material group	I
Insulation material	Polyamide (PA66)
Flammability class per UL94	V0
Clamping spring material	Chrome-nickel spring steel (CrNi)
Contact material	Copper or copper alloy; surface-treated
Contact plating	Tin
Fire load	0.075 MJ
Weight	4.4 g

## Environmental requirements

Processing temperature	-5 ... +40 °C
Continuous operating temperature	-35 ... +85 °C
Note on continuous operating temperature	Insulating parts for temperatures $\leq$ 105 °C

## Commercial data

Product Group	20 (Winsta)
eCl@ss 10.0	27-44-06-05
eCl@ss 9.0	27-44-06-05
ETIM 8.0	EC002560
ETIM 7.0	EC002560
PU (SPU)	50 pcs
Packaging type	box
Country of origin	PL
GTIN	4050821695554
Customs tariff number	85366990990

## Environmental Product Compliance

RoHS Compliance Status	Compliant, No Exemption
------------------------	-------------------------

## Approvals / Certificates

### General approvals



Subject to changes. Please also observe the further product documentation!

WAGO GmbH & Co. KG  
 Hansastr. 27  
 32423 Minden  
 Phone: +49571 887-0 | Fax: +49571 887-169  
 Email: [info.de@wago.com](mailto:info.de@wago.com) | Web: [www.wago.com](http://www.wago.com)



Do you have any questions about our products?  
 We are always happy to take your call at +49 (571) 887-44222.

Logo	Approval	Additional Approval Text	Certificate name
	CCA DEKRA Certification B.V.	EN 61535	71- 123231
	CCA DEKRA Certification B.V.	IEC 61535	NL-85020
	cURus Underwriters Laboratories Inc.	UL 1977	E45171

## Declarations of conformity and manufacturer's declarations





Logo	Approval	Additional Approval Text	Certificate name
	EU-Declaration of Conformity WAGO GmbH & Co. KG	-	-
	UK-Declaration of Conformity WAGO GmbH & Co. KG	-	-

## Approvals for marine applications

Logo	Approval	Additional Approval Text	Certificate name
	ABS American Bureau of Shipping	Steel Vessel Rules	19- HG1869855- PDA
	DNV GL Det Norske Veritas, Germanischer Lloyd	-	TAE00001Z6
	LR Lloyds Register	EN 61535	08/20047 (E2)

Subject to changes. Please also observe the further product documentation!

## Counterpart

	<b>Item no.890-134</b> Plug; with strain relief housing; 4-pole; 1,50 mm <sup>2</sup> ; white	<a href="http://www.wago.com/890-134">www.wago.com/890-134</a>
	<b>Item no.890-234</b> Plug; 4-pole; Cod. A; 1,50 mm <sup>2</sup> ; white	<a href="http://www.wago.com/890-234">www.wago.com/890-234</a>
	<b>Item no.891-8994/006-102</b> pre-assembled interconnecting cable; Eca; Socket/plug; 4-pole; Cod. A; H05VV-F 4G 1.5 mm <sup>2</sup> ; 1 m; 1,50 mm <sup>2</sup> ; white	<a href="http://www.wago.com/891-8994/006-102">www.wago.com/891-8994/006-102</a>
	<b>Item no.891-8994/206-102</b> pre-assembled connecting cable; Eca; Plug/open-ended; 4-pole; Cod. A; H05VV-F 4G 1.5 mm <sup>2</sup> ; 1 m; 1,50 mm <sup>2</sup> ; white	<a href="http://www.wago.com/891-8994/206-102">www.wago.com/891-8994/206-102</a>

## Downloads

### CAD/CAE-Data

#### PCB Design

Symbol and Footprint 890-824

URL

Download

CAX data for your PCB design, consisting of "schematic symbols and PCB footprints", allow easy integration of the WAGO component into your development environment.

#### Supported formats:

- Accel EDA 14 & 15
- Altium 6 to current version
- Cadence Allegro
- DesignSpark
- Eagle Libraries
- KiCad
- Mentor Graphics BoardStation
- Mentor Graphics Design Architect
- Mentor Graphics Design Expedition 99 and 2000
- OrCAD 9.X PCB and Capture
- PADS PowerPCB 3, 3.5, 4.X, and 5.X
- PADS PowerPCB and PowerLogic 3.0
- PCAD 2000, 2001, 2002, 2004, and 2006
- Pulsonix 8.5 or newer
- STL

Subject to changes. Please also observe the further product documentation!

WAGO GmbH & Co. KG

Hansastr. 27

32423 Minden

Phone: +49571 887-0 | Fax: +49571 887-169

Email: [info.de@wago.com](mailto:info.de@wago.com) | Web: [www.wago.com](http://www.wago.com)

Do you have any questions about our products?

We are always happy to take your call at +49 (571) 887-44222.



- 3D STEP
- TARGET 3001!
- View Logic ViewDraw
- Quadcept
- Zuken CadStar 3 and 4
- Zuken CR-5000 and CR-8000

PCB Component Libraries (EDA), PCB CAD Library Ultra Librarian

---

#### CAE data

ZUKEN Portal 890-824	<a href="#">URL</a>	<a href="#">Download</a>
----------------------	---------------------	--------------------------

---

#### CAD data

2D/3D Models 890-824	<a href="#">URL</a>	<a href="#">Download</a>
----------------------	---------------------	--------------------------

---

### Environmental Product Compliance

#### Compliance Search

Environmental Product Compliance 890-824 Socket for PCBs; straight; 4-pole; Cod. A; white	<a href="#">URL</a>	<a href="#">Download</a>
--	---------------------	--------------------------

---

### Installation Notes

#### Product family

**WINSTA® MINI**  
[Show all products from the family](#)

Subject to changes. Please also observe the further product documentation!