

1	Connection for Standard Use	CHS-39
2	Wiring Input/Output Pin	CHS-39
2.1	Wiring input pin	CHS-39
2.2	Wiring output pin	CHS-40
3	Function	CHS-40
3.1	Overcurrent protection	CHS-40
3.2	Overvoltage protection	CHS-40
3.3	Thermal protection	CHS-40
3.4	Remote ON/OFF	CHS-41
3.5	Remote sensing	CHS-41
3.6	Adjustable voltage range	CHS-41
3.7	Isolation	CHS-43
3.8	PMBus interface	CHS-43
4	Series and Parallel Operation	CHS-43
4.1	Series operation	CHS-43
4.2	Parallel operation	CHS-43
4.3	Redundancy operation	CHS-44
5	Cleaning	CHS-44
6	Storage method (CHS series:option S)	CHS-44
7	Safety Considerations	CHS-44
8	Temperature Measurement Location	CHS-44
9	SMD type(optionS) package information	CHS-49

1 Connection for Standard Use

■ In order to use the power supply, it is necessary to wire as shown in Fig.1.1.

Reference : 2 "Wiring Input/Output Pin"
8 "Temperature of measurement point"

■ Short the following pins to turn on the power supply.
-VIN↔RC, +VOUT↔+S, -VOUT↔-S

Reference : 3.4 "Remote ON/OFF"
3.5 "Remote sensing"

■ The CHS series handle only the DC input.
Avoid applying AC input directly.
It will damage the power supply.

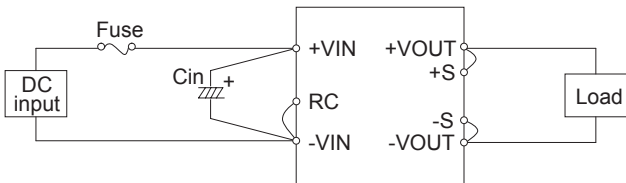

Cin : External capacitor on the input side

Fig.1.1 Connection for standard use

Table 1.1 Recommended External capacitor on the input side

Model	CHS12024	CHS30024	CHS40024	
Cin	220 μ F or more	660 μ F or more	660 μ F or more	
Model	CHS6048	CHS8048	CHS12048	CHS20048
Cin	66 μ F or more	33 μ F or more	47 μ F or more	100 μ F or more
Model	CHS30048/CHS38048/CHS40048/CHS50048			CHS70048
Cin	200 μ F or more			400 μ F or more

2 Wiring Input/Output Pin

2.1 Wiring input pin

(1) External fuse

■ Fuse is not built-in on input side. In order to protect the unit, install the normal-blow type fuse on input side.

■ When the input voltage from a front end unit is supplied to multiple units, install the normal-blow type fuse in each unit.

Table 2.1 Recommended fuse (Normal-blow type)

Model Input voltage [V]	CHS60	CHS80	CHS120	CHS200	CHS300
24	-	-	15A	-	20A (05/10/12/15) 30A (24/28/32/48)
48	5A	7A	10A	15A	15A
Model Input voltage [V]	CHS380	CHS400	CHS500	CHS700	
24	-	40A	-	-	
48	20A	20A	30A	30A	

(2) External capacitor on the input side

■ Install an external capacitor Cin, between +VIN and -VIN input pins for low line-noise and for stable operation of the power supply.

Capacitance Refer to Table 1.1
Ta = -20 to +85°C Electrolytic or Ceramic capacitor
Ta = -40 to +85°C Ceramic capacitor

■ Cin is within 50mm for pins. Make sure that ripple current of Cin is less than its rating.

(3) Recommendation for noise-filter

■ Install an external input filter as shown in Fig.2.1 in order to reduce conducted noise. For details refer to our website technical data.

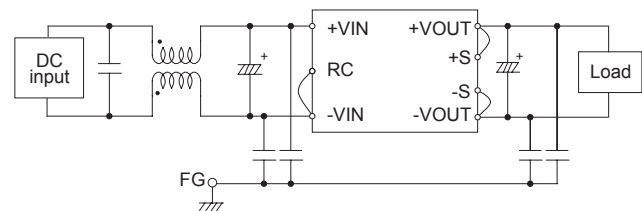

Fig.2.1 Recommended external input filter

(4) Reverse input voltage protection

■ Avoid the reverse polarity input voltage. It will damage the power supply.

It is possible to protect the unit from the reverse input voltage by installing an external diode as shown in Fig.2.2.

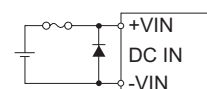

Fig.2.2 Reverse input voltage protection

2.2 Wiring output pin

■When the CHS series supplies the pulse current for the pulse load, please install a capacitor C_o between +VOUT and -VOUT pins.

Recommended capacitance of C_o is shown in Table 2.2, 2.3.

■If output current decreases rapidly, output voltage rises transiently and the overvoltage protection circuit may operate.

In this case, please install a capacitor C_o .

■Select a high frequency type capacitor. Output ripple and startup waveform may be influenced by ESR-ESL of the capacitor and the wiring impedance.

■Make sure that ripple current of C_o is than its rating.

Table 2.2 Recommended capacitance C_o
(CHS60/CHS80/CHS120/CHS200/CHS30024/CHS380)

No.	Output voltage	CHS60	CHS80	CHS120	CHS200/ CHS30024/ CHS380
1	3.3V	0 - 20,000 μ F	0 - 20,000 μ F	0 - 20,000 μ F	0 - 40,000 μ F
2	5V	0 - 10,000 μ F	0 - 10,000 μ F	0 - 10,000 μ F	0 - 20,000 μ F
3	10V	—	—	—	0 - 2,200 μ F
4	12V	0 - 2,200 μ F	0 - 1,000 μ F	0 - 2,200 μ F	0 - 2,200 μ F
5	15V	—	—	0 - 2,200 μ F	0 - 2,200 μ F
6	24V	—	—	0 - 1,000 μ F	0 - 2,200 μ F
7	28V	—	—	—	0 - 2,200 μ F
8	32V	—	—	—	0 - 2,200 μ F
9	48V	—	—	—	0 - 1,000 μ F

Table 2.3 Recommended capacitance C_o
(CHS30048/CHS400/CHS500/CHS700)

No.	Output voltage	CHS30048	CHS40024	CHS40048/ CHS500	CHS700
1	10V	0 - 2,200 μ F	—	0 - 4,000 μ F	—
2	12V	0 - 2,200 μ F	0 - 4,000 μ F	0 - 4,000 μ F	0 - 10,000 μ F
3	15V	0 - 2,200 μ F	0 - 4,000 μ F	0 - 4,000 μ F	—
4	24V	0 - 2,200 μ F	0 - 3,300 μ F	0 - 3,300 μ F	—
5	28V	0 - 1,000 μ F	0 - 3,300 μ F	0 - 3,300 μ F	—
6	32V	0 - 1,000 μ F	0 - 3,300 μ F	0 - 3,300 μ F	—
7	48V	0 - 1,000 μ F	0 - 2,200 μ F	0 - 1,000 μ F	—

■Ripple and Ripple Noise are measured, as shown in the Fig.2.3.

C_{in} is shown in Table 1.1.

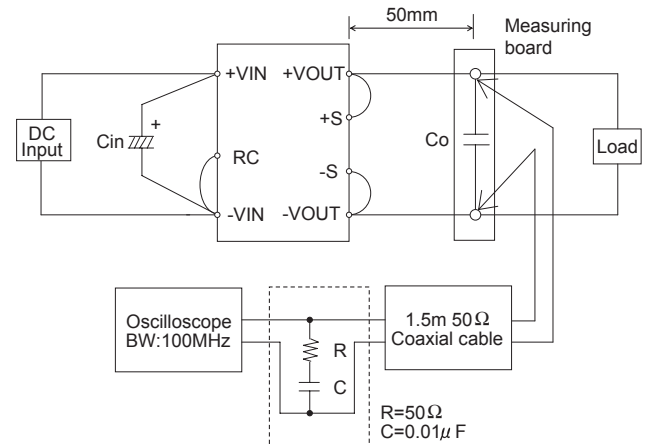

Output voltage	C_o
3.3 - 15V	22 μ F
24 - 48V	0.1 μ F

Fig.2.3 Measuring method of Ripple and Ripple Noise

3 Function

3.1 Overcurrent protection

■Over Current Protection (OCP) is built-in and works over 105% of the rated current or higher. However, use in an overcurrent situation must be avoided whenever possible.

The output voltage of the power module will recover automatically when the fault causing overcurrent is corrected.

When the output voltage drops after OCP works, the power module enters a "hiccup mode" where it repeatedly turns on and off at a certain frequency.

3.2 Overvoltage protection

■The overvoltage protection circuit is built-in. The DC input will be shut down if overvoltage protection is in operation.

The output voltage of the power module will recover automatically when the fault causing over voltage is corrected.

Remarks :

Please avoid applying a voltage exceeding the rated voltage to an output pin.

Doing so may cause power supply to malfunction or fail. This could happen when the customer tests the overvoltage performance of the unit.

If this is unavoidable, for example, if you need to operate a motor, etc., please install an external diode on the output pin to protect the unit.

3.3 Thermal protection

■When the power supply temperature is kept above 120°C, the thermal protection will be activated and simultaneously shut down the output.

The output voltage of the power supply will recover automatically when the unit is cool down.

●-U

■Option “-U” means output is shut down when the abovementioned protection circuit is activated.

If this happens, protection circuit can be inactivated by cycling the DC input power off for at least 1 second or toggling Remote ON/OFF signal.

3.4 Remote ON/OFF

■Remote ON/OFF circuit is built-in on the input side (RC).

The ground pin of input side remote ON/OFF circuit is “-VIN” pin.

Table 3.1.1 Specification of Remote ON/OFF(CHS80,CHS200)

	ON/OFF logic	Between RC and -VIN	Output voltage
Standard	Negative	L level(0 - 0.8V) or short	ON
		H level(2.0 - 7.0V) or open	OFF
Optional -R	Positive	L level(0 - 0.8V) or short	OFF
		H level(2.0 - 7.0V) or open	ON

When RC is “Low” level, fan out current is 0.1mA typ. When V_{CC} is applied, use $2.0 \leq V_{CC} \leq 7.0V$.

Table 3.1.2 Specification of Remote ON/OFF (CHS60,CHS120,CHS300,CHS380,CHS400,CHS500,CHS700)

	ON/OFF logic	Between RC and -VIN	Output voltage
Standard	Negative	L level(0 - 0.8V) or short	ON
		H level(4.0 - 7.0V) or open	OFF
Optional -R	Positive	L level(0 - 0.8V) or short	OFF
		H level(4.0 - 7.0V) or open	ON

When RC is “Low” level, fan out current is 0.1mA typ. When V_{CC} is applied, use $4.0 \leq V_{CC} \leq 7.0V$.

■When remote ON/OFF function is not used, please short between RC and -VIN (-R: open between RC and -VIN).

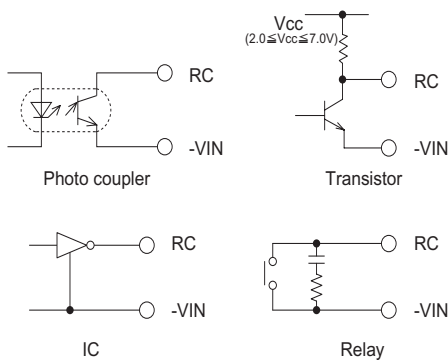

Fig.3.1 RC connection example

3.5 Remote sensing

(1) When the remote sensing function is not in use

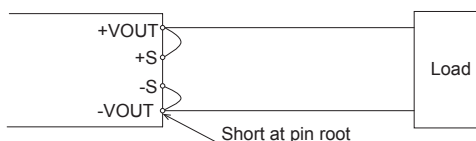

Fig.3.2 Connection when the remote sensing is not in use

■When the remote sensing function is not in use, it is necessary to confirm that pins are shorted between +S & +VOUT and between -S & -VOUT.

■Wire between +S & +VOUT and between -S & -VOUT as short as possible.

Loop wiring should be avoided.

This power supply might become unstable by the noise coming from poor wiring.

(2)When the remote sensing function is in use

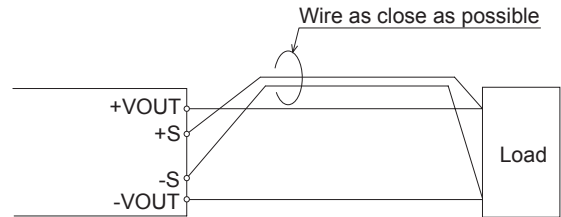

Fig.3.3 Connection when the remote sensing is in use

■Twisted-pair wire or shield wire should be used for sensing wire.

■Thick wire should be used for wiring between the power supply and a load.

Line drop should be less than 0.3V.

Voltage between +VOUT and -VOUT should remain within the output voltage adjustment range.

■If the sensing patterns are short, heavy-current is drawn and the pattern may be damaged.

The pattern disconnection can be prevented by installing the protection parts as close as possible to a load.

■Output voltage might become unstable because of impedance of wiring and load condition when length of wire exceeds 40cm.

3.6 Adjustable voltage range

(1) To adjust output voltage

■Output voltage is adjustable by the external potentiometer.

■When the output voltage adjustment is used, note that the over voltage protection circuit operates when the output voltage is set too high.

■If the output voltage drops under the output voltage adjustment range, the Low voltage protection operates.

■By connecting the external potentiometer (VR1) and resistors (R1, R2), output voltage becomes adjustable, as shown in Fig.3.4.

Recommended external parts are shown in Table 3.2.

■The wiring to the potentiometer should be as short as possible.

The temperature coefficient could become worse, depending on the type of a resistor and potentiometer. Following parts are recommended for the power supply.

Resistor······Metal film type, coefficient of less than $\pm 100\text{ppm}/^\circ\text{C}$

Potentiometer·····Cermet type, coefficient of less than $\pm 300\text{ppm}/^\circ\text{C}$

■When the output voltage adjustment is not used, open the TRM pin respectively.

■The change speed of the TRM voltage should be less than 0.15V/ms.

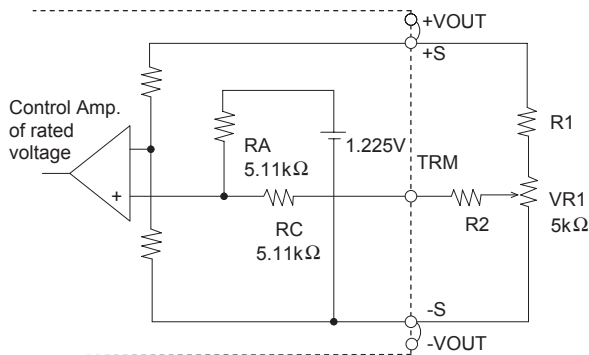

(a) Rated output voltage 3.3 - 15V

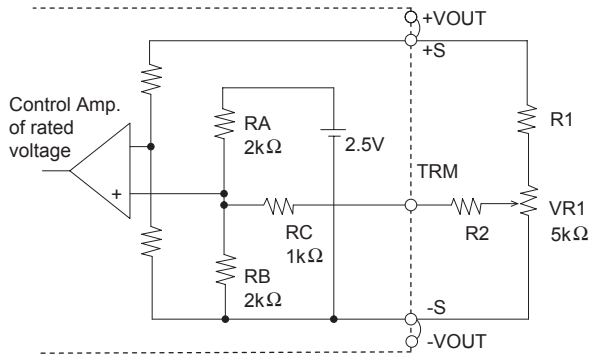

(b) Rated output voltage 24 - 48V

Fig.3.4 Output voltage control circuit

Table 3.2 Recommended value of external potentiometer & resistor

No.	VOUT	Output adjustable range					
		VOUT ±5%			VOUT ±10%		
		R1	R2	VR1	R1	R2	VR1
1	3.3V	2.2kΩ	68kΩ	5kΩ	2.2kΩ	33kΩ	5kΩ
2	5V	4.7kΩ	68kΩ		5.6kΩ	33kΩ	
3	10V	15kΩ	68kΩ		15kΩ	33kΩ	
4	12V	18kΩ	68kΩ		18kΩ	33kΩ	
5	15V	22kΩ	68kΩ		22kΩ	33kΩ	
6	24V	33kΩ	11kΩ		33kΩ	6.2kΩ	
7	28V	39kΩ	11kΩ		39kΩ	6.2kΩ	
8	32V	51kΩ	11kΩ		51kΩ	6.2kΩ	
9	48V	75kΩ	11kΩ		75kΩ	6.2kΩ	

(2) To decrease output voltage

By connecting the external resistor (RD), output voltage becomes adjustable to decrease.

The external resistor (RD) is calculated by the following equation.

(a) Rated output voltage : 3.3 - 15V

$$RD = \frac{5.11}{\Delta} - 10.22 \text{ [k}\Omega\text{]}$$

(b) Rated output voltage : 24 - 48V

$$RD = \frac{1}{\Delta} - 2 \text{ [k}\Omega\text{]}$$

$$\Delta = \frac{V_{OR} - V_{OD}}{V_{OR}}$$

V_{OR} : Rated output voltage [V]

V_{OD} : Output voltage needed to set up [V]

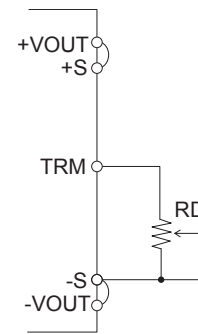

Fig.3.5 Connection to decrease output voltage

(3) To increase output voltage

By connecting the external resistor (RU), output voltage becomes adjustable to increase.

The external resistor (RU) is calculated by the following equation.

(a) Rated output voltage : 3.3 - 15V

$$RU = \frac{5.11 \times V_{OR} \times (1 + \Delta)}{1.225 \times \Delta} - \frac{5.11}{\Delta} - 10.22 \text{ [k}\Omega\text{]}$$

(b) Rated output voltage : 24 - 48V

$$RU = \frac{V_{OR} \times (1 + \Delta)}{1.225 \times \Delta} - \frac{1 + 2 \times \Delta}{\Delta} \text{ [k}\Omega\text{]}$$

$$\Delta = \frac{V_{OU} - V_{OR}}{V_{OR}}$$

V_{OR} : Rated output voltage [V]

V_{OU} : Output voltage needed to set up [V]

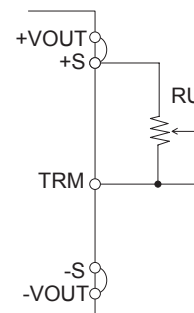

Fig.3.6 Connection to increase output voltage

(4) Input voltage derating

■When input voltage is 18-21.5V DC or 36-44VDC, the output voltage adjustment range becomes as shown in Fig.3.7.

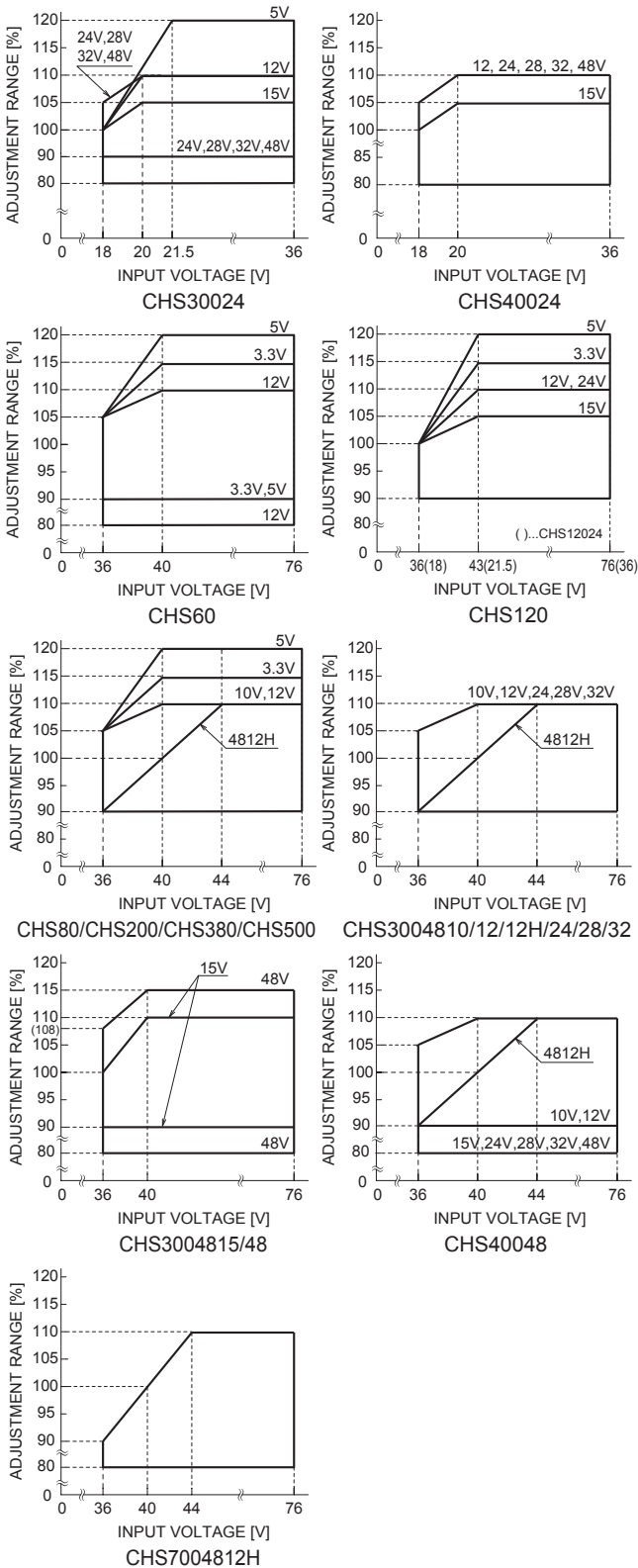

Fig.3.7 CHS Output Voltage Adjustment Range

3.7 Isolation

■For a receiving inspection, such as Hi-Pot test, gradually increase (decrease) the voltage to start (shut down). Avoid using Hi-Pot tester with timer because it may generate voltage a few times higher than the applied voltage at ON/OFF of a timer.

3.8 PMBus interface

●-I (CHS300,CHS400,CHS500)

■This option is equipped with a digital PMBus interface. Please contact us about for details.

4 Series and Parallel Operation

4.1 Series operation

■Series operation is available by connecting the outputs of two or more power supplies, as shown below. Output current in series connection should be lower than the lowest rated current in each unit.

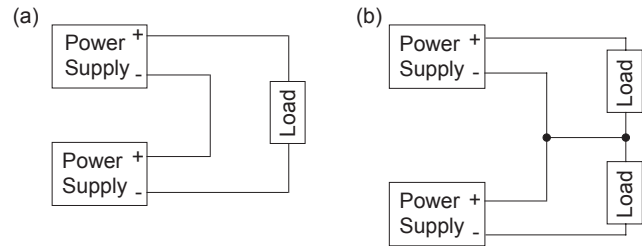

Fig.4.1 Examples of series operation

4.2 Parallel operation

●-P (CHS400,CHS500)

■This option is for parallel operation.
 ■Sensing and adjustment of the output voltage are not possible at the time of the use with this option.
 ■As variance of output current drew from each power supply is maximum 10%, the total output current must not exceed the value determined by the following equation.

(Output current in parallel operation)
 =(the rated current per unit) x (number of unit) x0.9

When the number of units in parallel operation increases, input current increase at the same time. Adequate wiring design for input circuitry is required, such as circuit pattern, wiring and current capacity for equipment.

- Total number of units should be no more than 3 pieces.
- Thick wire should be used for wiring between the power supply and load, and line drop should be less than 0.3V.
- Connect each input pin for the lowest possible impedance.
- When the number of the units in parallel operation increases, input current increases. Adequate wiring design for input circuitry such as circuit pattern, wiring and current for equipment is required.

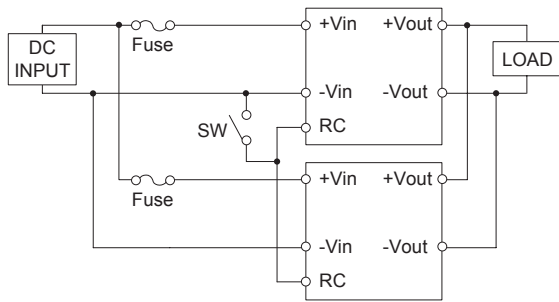

Fig.4.2 Examples of parallel operation

4.3 Redundancy operation

- Parallel operation is not possible.
- Redundancy operation is available by wiring as shown below.

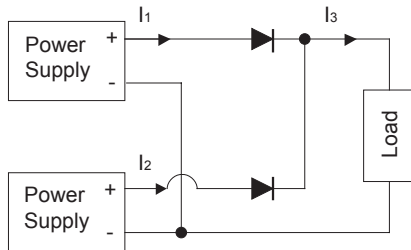

Fig.4.3 Redundancy operation

- Even a slight difference in output voltage can affect the balance between the values of I_1 and I_2 . Please make sure that the value of I_3 does not exceed the rated current of the power supply.

$$I_3 \leq \text{the rated current value}$$

5 Cleaning

- When cleaning is necessary, clean under the following conditions.
 - Method : Immersion, ultrasonic wave and vapor
 - Cleaning agents : IPA (Solvent type)
 - Total time : 2 minutes or less
- Do not apply pressure to the lead and name plate with a brush or scratch it during the cleaning.
- After cleaning, dry them enough.

6 Storage method (CHS series:option S)

- To stock unpacked products in your inventory, it is recommended to keep them under controlled condition, 5-30°C, 60%RH and use them within a year.
- 24-hour baking is recommended at 125°C, if unpacked products were kept under uncontrolled condition, which is 30°C, 60%RH or higher. Original trays are not heat-resistant. Please move them to heat-resistant trays in preparation to bake. To check moisture condition in the pack. Silica gel packet has some moisture condition indicator particles. Indicated blue means good. Pink means alarm to bake it.
- Notification. The tray will be deformed and the power supply might be damaged, if the vacuum pressure is too much to reseal.

7 Safety Considerations

- To apply for safety standard approval using this power supply, the following conditions must be met.
 - This unit must be used as a component of the end-use equipment.
 - The equipment must contain basic insulation between input and output. If double or reinforced insulation is required, it has to be provided by the end-use equipment in accordance with the final build-in condition.
 - Safety approved fuse must be externally installed on input side.

8 Temperature Measurement Location

- It is necessary to note thermal fatigue life by power cycle. Please reduce the temperature fluctuation range as much as possible when the up and down of temperature are frequently generated.
- Use with the convection cooling or the forced air cooling. Make sure the temperatures at temperature measurement locations shown from Fig.8.2.1 to Fig.8.2.14 below are on or under the derating curve in Fig.8.1. Ambient temperature must be kept at 85°C or under.

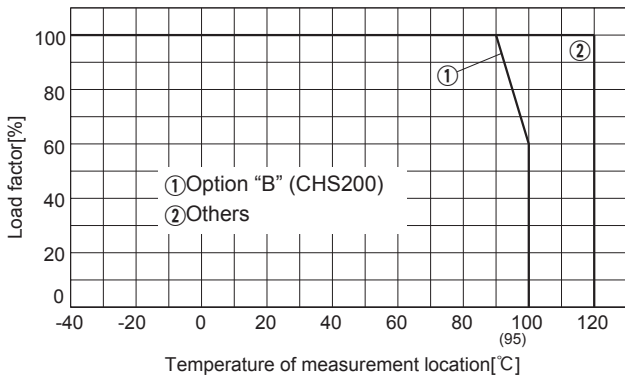

(a) CHS60, CHS80, CHS200

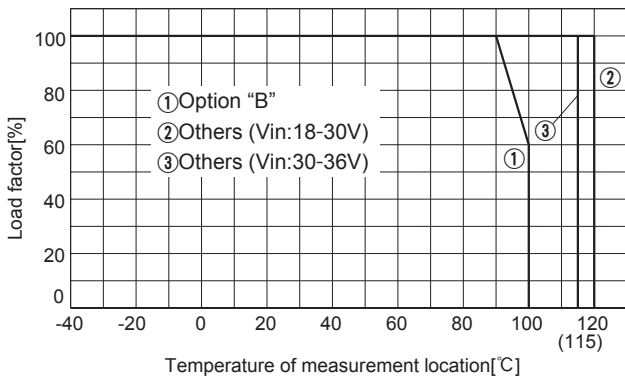

(b) CHS12024

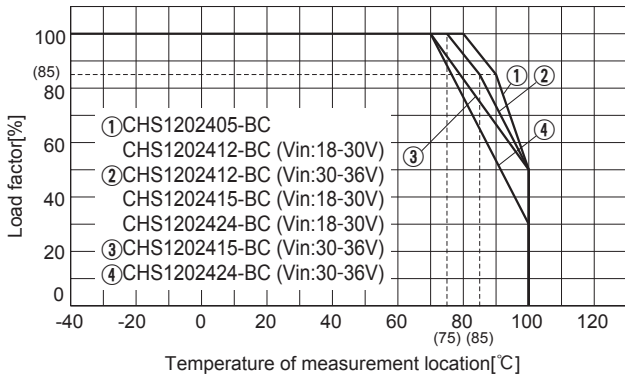

(c) CHS12024-BC

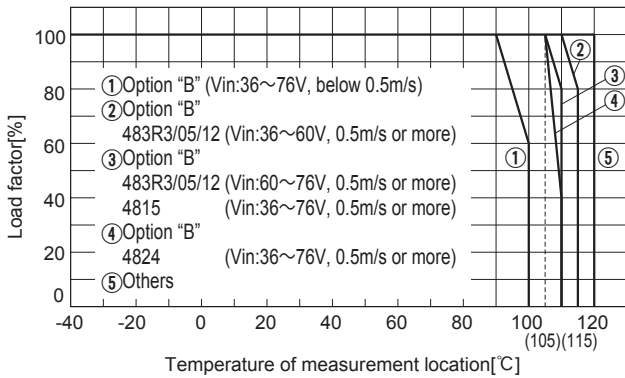

(d) CHS12048

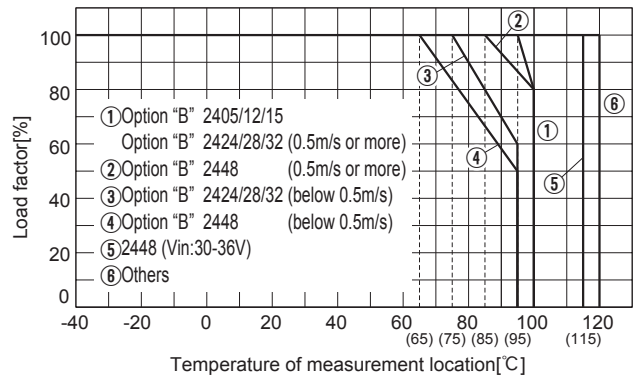

(e) CHS3002405/12/15/24/28/32/48

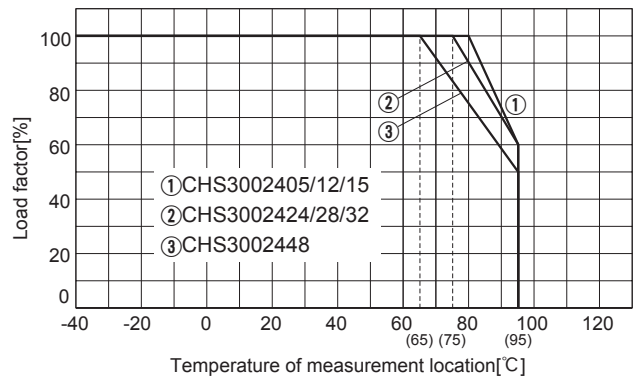

(f) CHS3002405/12/15/24/28/32/48-BC

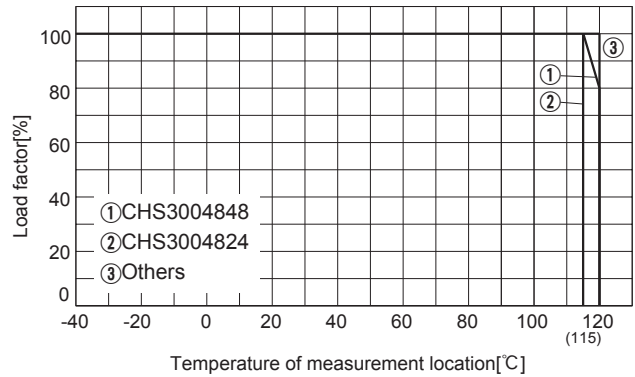

(g) CHS3004810/12/12H/15/24/28/32/48

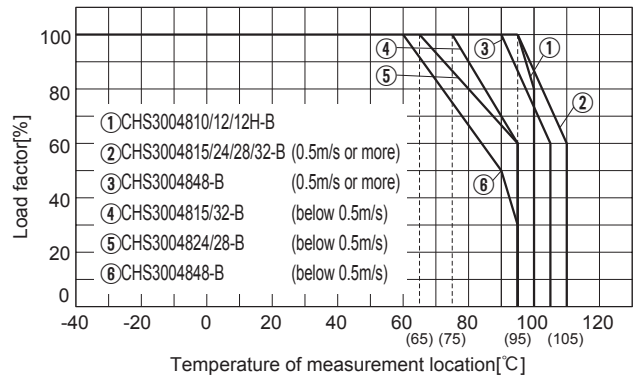

(h) CHS3004810/12/12H/15/24/28/32/48-B

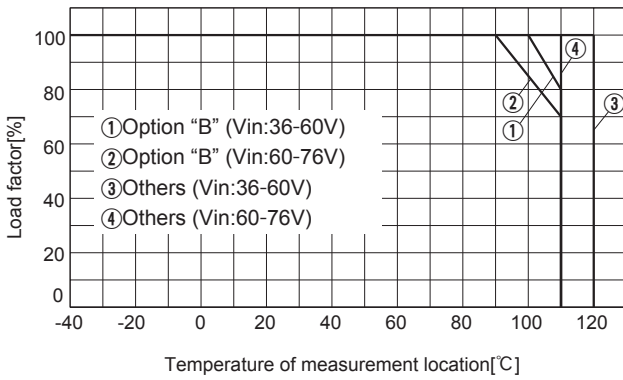

(i) CHS3804812/CHS3804812H

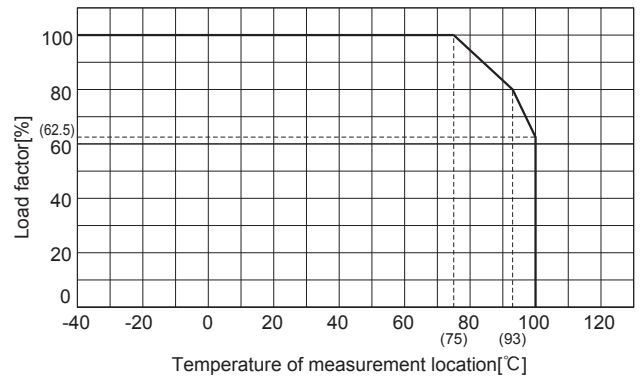

(m) CHS4002424/28/32/48-BC

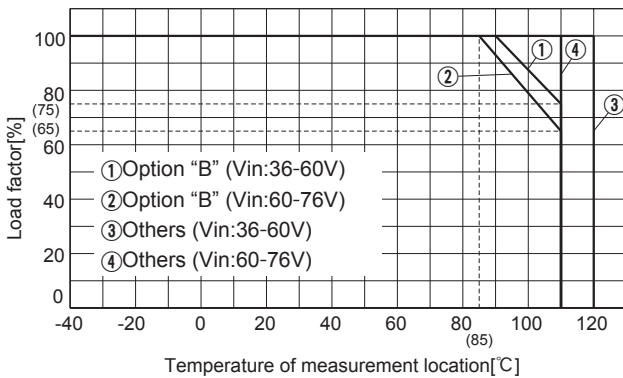

(j) CHS3804810

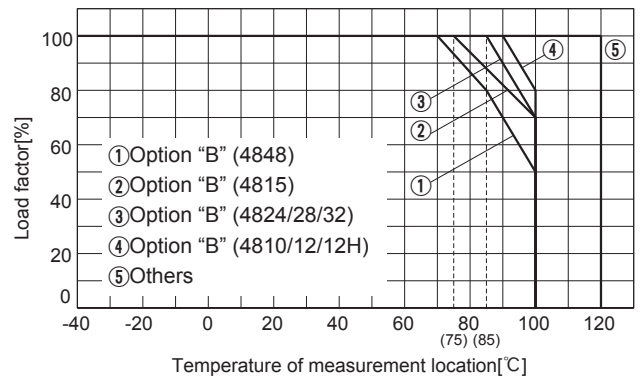

(n) CHS40048

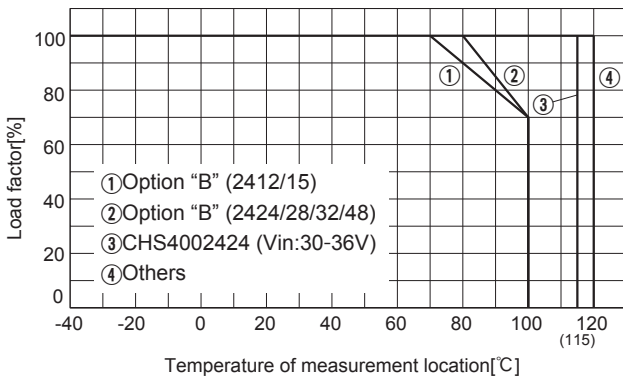

(k) CHS40024

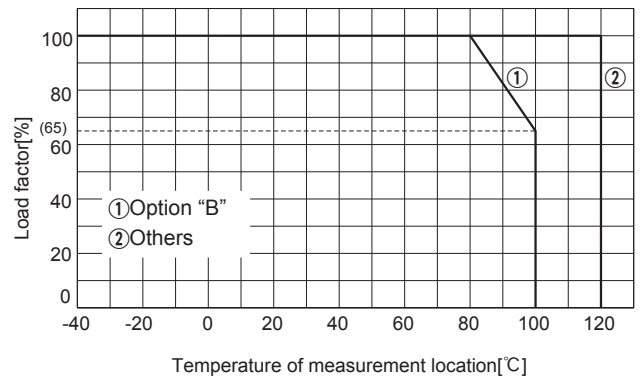

(o) CHS500

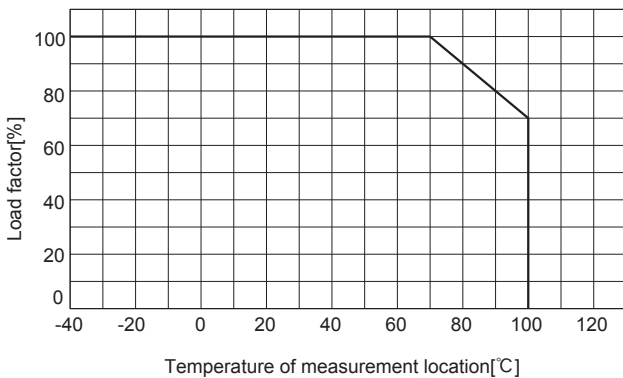

(l) CHS4002412/15-BC

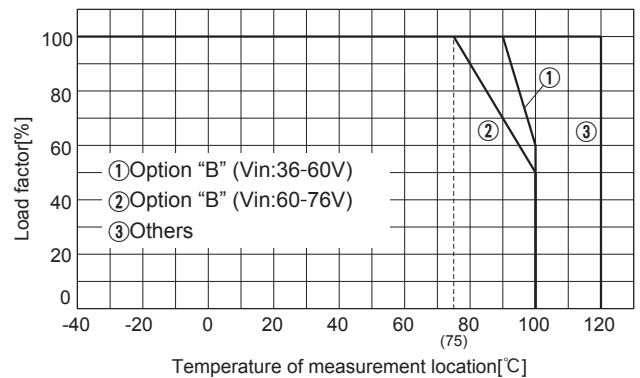

(p) CHS700

Fig.8.1 Derating curve

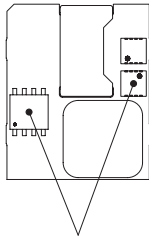

Temperature measurement location

Fig.8.2.1 Temperature measurement location (CHS60)

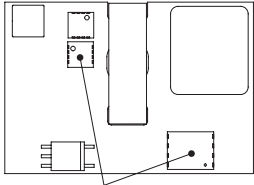

Temperature measurement location

Fig.8.2.2 Temperature measurement location (CHS80)

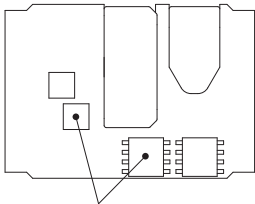

Temperature measurement location

Fig.8.2.3 Temperature measurement location (CHS120)

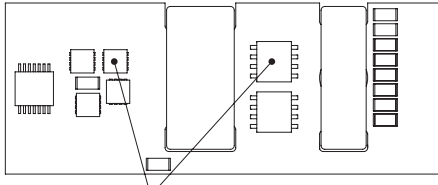

Temperature measurement location

Fig.8.2.4 Temperature measurement location (CHS200)

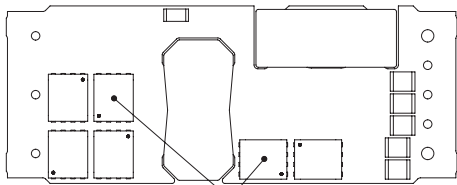

Temperature measurement location

Fig.8.2.5 Temperature measurement location (CHS3002405/12/15, CHS3004810/12/12H)

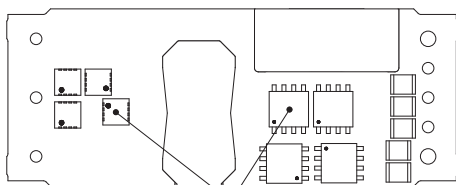

Temperature measurement location

Fig.8.2.6 Temperature measurement location (CHS3002424/28/32/48, CHS3004815/24/28/32/48)

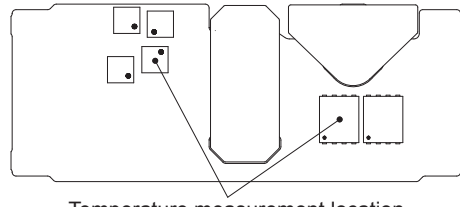

Temperature measurement location

Fig.8.2.7 Temperature measurement location (CHS380)

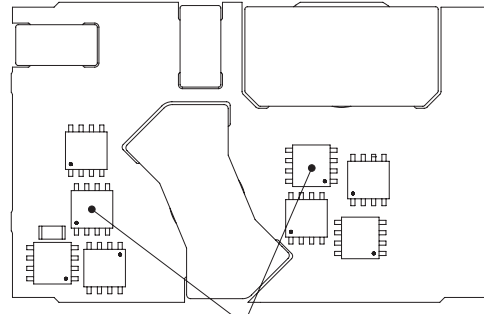

Temperature measurement location

Fig.8.2.8 Temperature measurement location (CHS40024, CHS4004815/24/28/32/48)

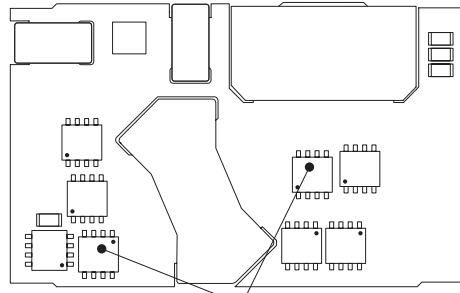

Temperature measurement location

Fig.8.2.9 Temperature measurement location (CHS4004810/12/12H)

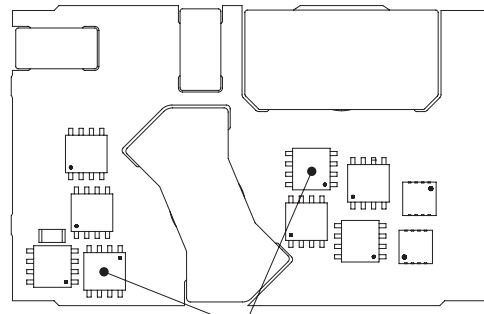

Temperature measurement location

Fig.8.2.10 Temperature measurement location (CHS500)

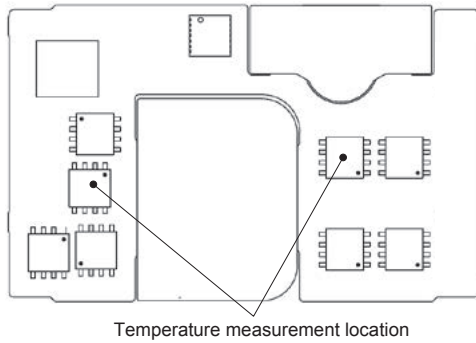

Temperature measurement location

Fig.8.2.11 Temperature measurement location (CHS700)

■For option “B” which is used with the convection cooling, forced air cooling or conduction cooling, use the temperature measurement location as shown in Fig.8.2.12 to Fig.8.2.14.

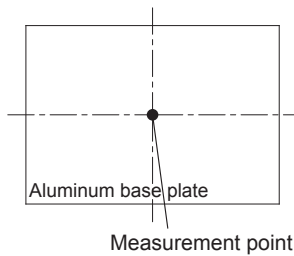

Fig.8.2.12 Measurement point (CHS120 option “B” and “BC”)

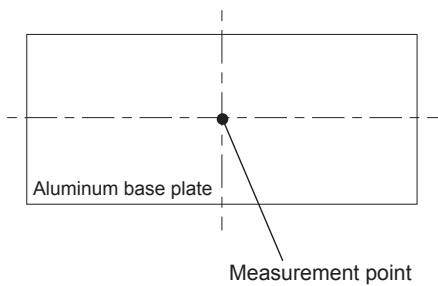

Fig.8.2.13 Measurement point (CHS200/CHS300/CHS380 option “B” and “BC”)

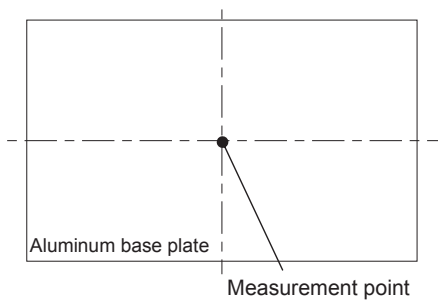

Fig.8.2.14 Measurement point (CHS400/CHS500/CHS700 option “B” and “BC”)

■Shown the measurement point for ambient temperature as shown in Fig.8.3.

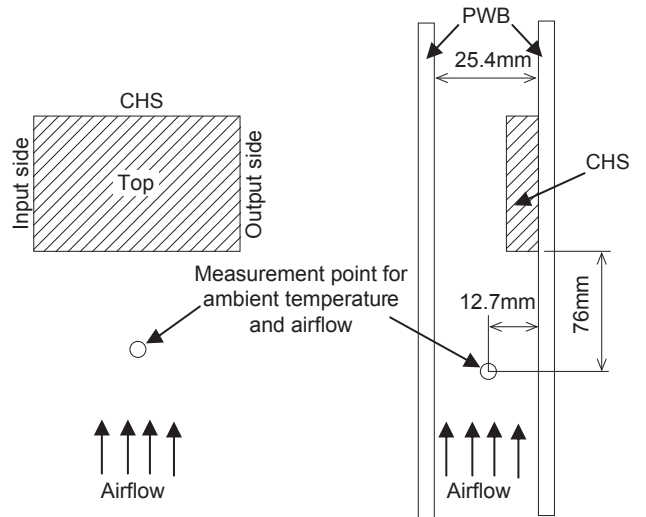

Fig.8.3 Measuring method

9 SMD type(option S) package information

■ These are packed in a tray (Fig.9.1 to Fig.9.3).

Please order “CHS60□□-S”, “CHS80□□-S”, “CHS120□□-S” for tray type packaging.

Capacity of the tray is 15max.

In case of fractions, the units are stored in numerical order.

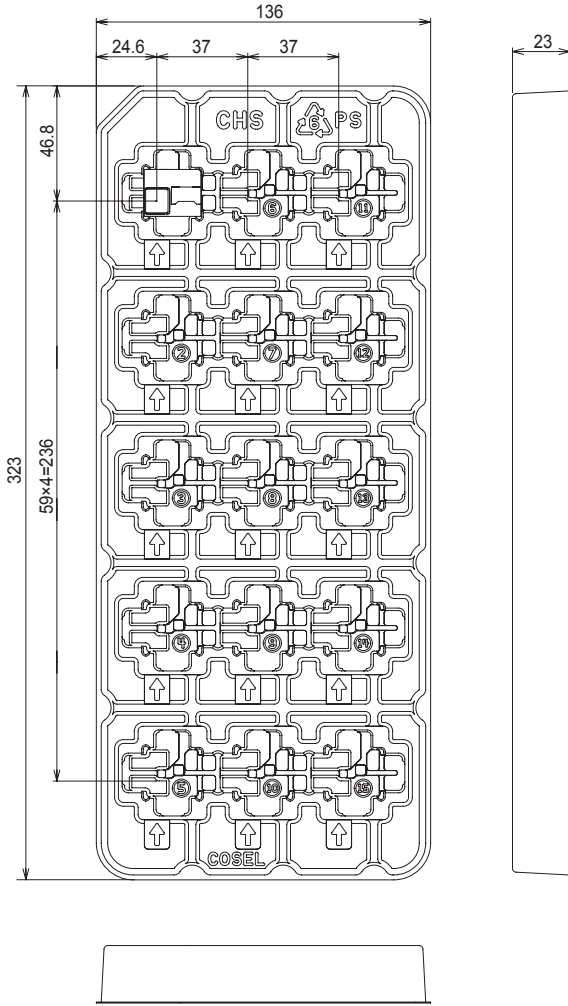

Dimensions in mm
Material : Conductive PS

Fig.9.1 Delivery package information (CHS60)

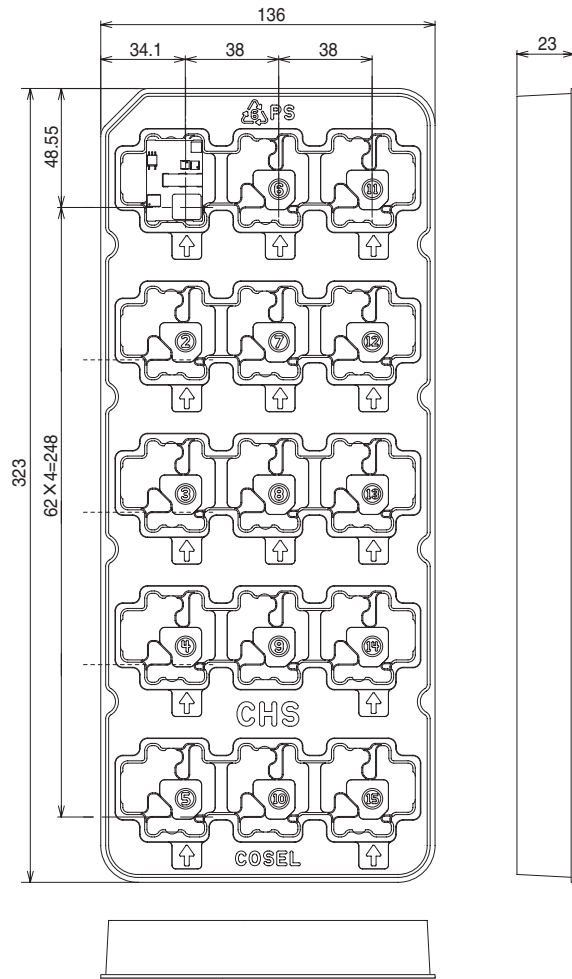

Dimensions in mm
Material : Conductive PS

Fig.9.2 Delivery package information (CHS80)

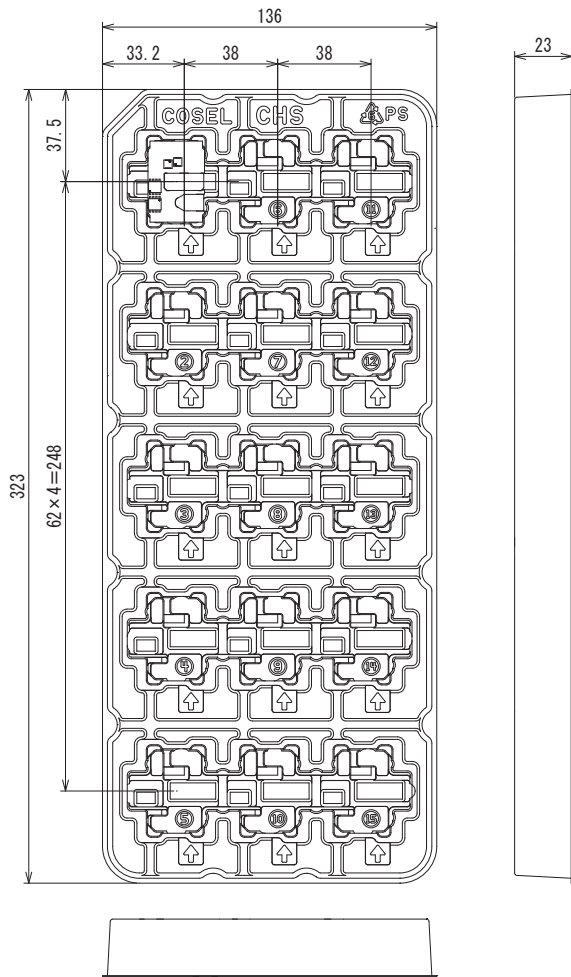

Dimensions in mm
Material : Conductive PS

Fig.9.3 Delivery package information (CHS120)