

REVISIONS					
REV	ECO	DESCRIPTION	DATE	BY	APPR
A3	-	RELEASE NEW DRAWING FORMAT	11DEC13	DRP	-

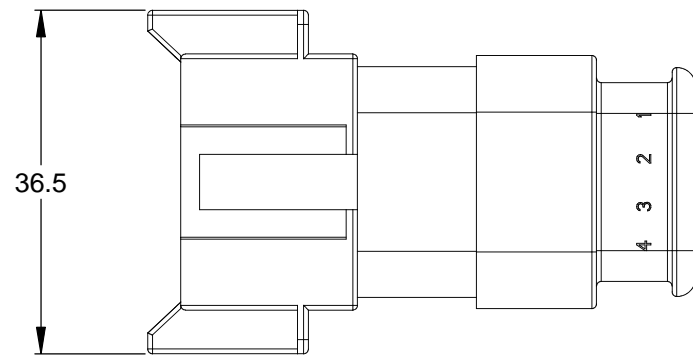

36.5

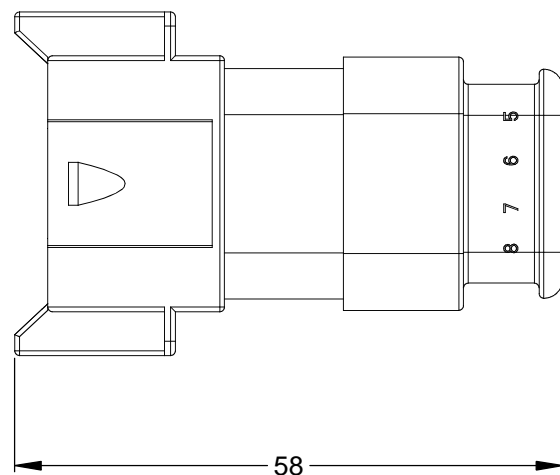
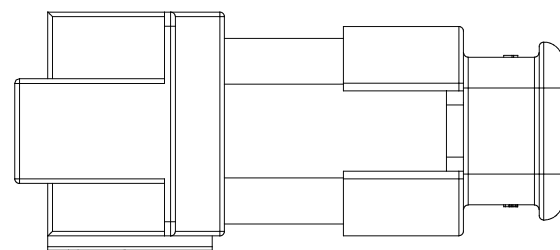

58

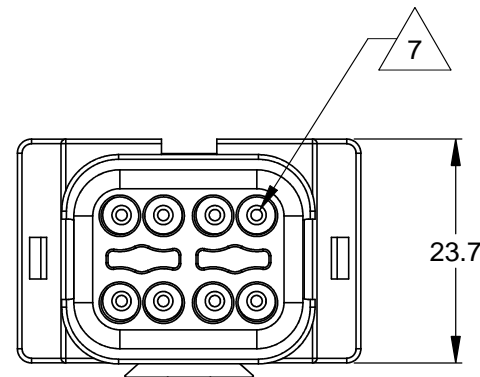

23.7

STRAIN RELIEF
END CAP -
BLACK - ALL
CONNECTORS

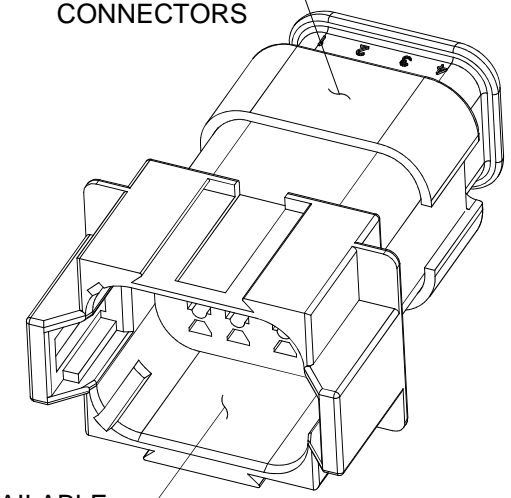

1 REFER TO SHEET 2 FOR AVAILABLE
CONNECTOR HOUSING COLORS

REQUIRES CONTACT
RETENTION WEDGE AW8P

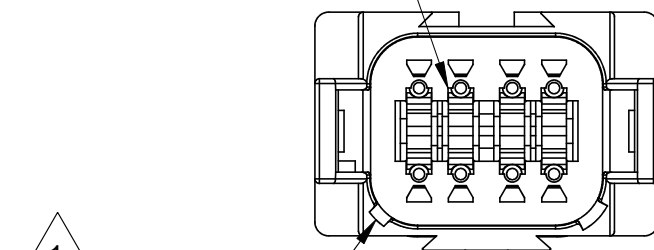

1
KEYWAY (2) PLACES

NOTES: UNLESS OTHERWISE SPECIFIED

1 SEE SHEET 2 FOR KEY ARRANGEMENTS AND COLORS.

2. MATERIAL:
HOUSING: THERMOPLASTIC
SEAL: SILICONE RUBBER

3. MODIFICATIONS: STRAIN RELIEF END CAP

4. SPECIFICATIONS:
4.1 CURRENT RATING: 13 AMPS
4.2 OPERATING TEMPERATURE: -55°C TO +125°C
4.3 DIELECTRIC WITHSTANDING VOLTAGE: LESS THAN 2
MILLIAMPS CURRENT LEAKAGE @ 1500 VOLTS AC.
4.4 INSULATION RESISTANCE: 1000 MEGOHMS MIN @ 25°C.
4.5 MOISTURE RESISTANCE: IP67 (MATED CONDITION)
4.6 MATING CYCLE DURABILITY: 100 CYCLES
4.7 RoHS COMPLIANT

5. MATING PART: AT06-08SX* PLUG
(X = A,B,C,D KEYS; * = MODIFICATIONS AND COLORS)

6. ALL DIMENSIONS ARE FOR REFERENCE USE ONLY.

7 CONTACT SIZE AND REAR SEAL WIRE RANGE:

CONTACT SIZE	MIN. INSUL O.D.	MAX. INSUL O.D.	TYPICAL WIRE RANGE
16	2.24 mm (.088 in)	3.68 mm (.145 in)	14 - 20 AWG

QUANTITY	SEE SHEET 2 PART NUMBER	DESCRIPTION	ITEM
MATERIALS LIST			
UNLESS OTHERWISE SPECIFIED 1) All dimensions are in metric (mm). 2) Tolerances are as follows: 1 PL DEC ±0.30 2 PL DEC ±0.15 3 PL DEC ±0.08 Fractions ±1/64 Angles ±1° 3) Note reference = X		SIGNATURES DRAWN: D.PARKS CHECKED: ENGINEER: APPROVAL:	DATE 11DEC13
MATERIAL SPECIFICATIONS:		Amphenol Sine Systems - www.amphenol-sine.com 44724 Morley Drive Clinton Township, MI 48036	
PROCESS SPECIFICATIONS:		RECEPTACLE, 8 PIN, AT SERIES, KEYED, STRAIN RELIEF END CAP	
NEXT ASSY:	CUSTOMER: THIS DRAWING IS SUPPLIED FOR INFORMATION ONLY. DESIGN FEATURES, SPECIFICATIONS AND PERFORMANCE DATA SHOWN HEREON ARE THE PROPERTY OF THE AMPHENOL CORPORATION. NO RIGHTS OF REPRODUCTION ARE IMPLIED. ALL DIMENSIONS ARE SUBJECT TO NORMAL MANUFACTURING VARIATIONS.	SIZE B C-	DWG NO: AT04-08PX-SRXXX
		REVISION A3	
	SCALE: NONE	SHEET 1	OF 2

TITLE: RECEPTACLE, 8 PIN, AT SERIES, KEYED, STRAIN RELIEF END CAP

DWG NO: AT04-08PX-SRXXX

REV: A3

SH: 1

OF: 2

REVISIONS					
REV	ECO	DESCRIPTION	DATE	BY	APPR

P/N AT04-08PA-SRGRY
KEY-A CONFIGURATION
STANDARD COLOR: GREY

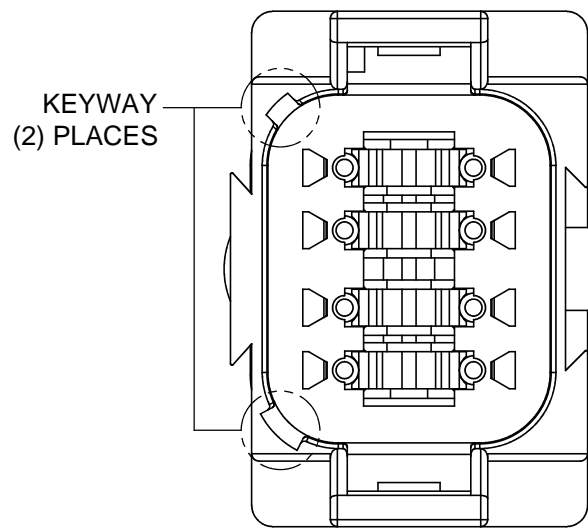

KEY-A CONFIGURATION	
COLOR	PART NUMBER
* GREY	AT04-08PA-SRGRY
BLACK	AT04-08PA-SRBK
GREEN	AT04-08PA-SRGN
BROWN	AT04-08PA-SRBR

P/N AT04-08PB-SRBK
KEY-B CONFIGURATION
STANDARD COLOR: BLACK

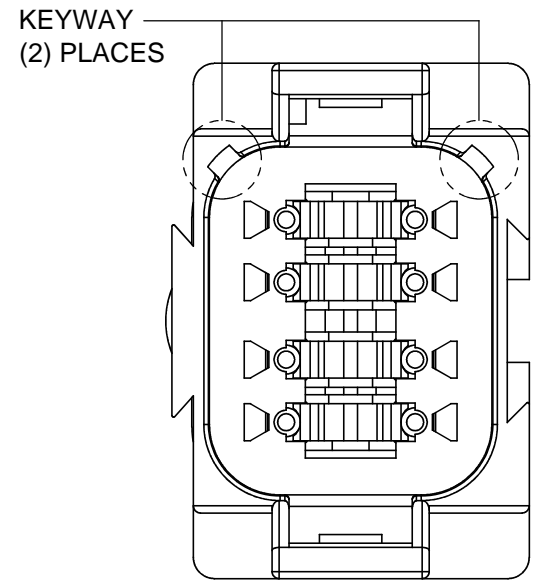

KEY-B CONFIGURATION	
COLOR	PART NUMBER
GREY	AT04-08PB-SRGRY
* BLACK	AT04-08PB-SRBK
GREEN	AT04-08PB-SRGN
BROWN	AT04-08PB-SRBR

P/N AT04-08PC-SRGN
KEY-C CONFIGURATION
STANDARD COLOR: GREEN

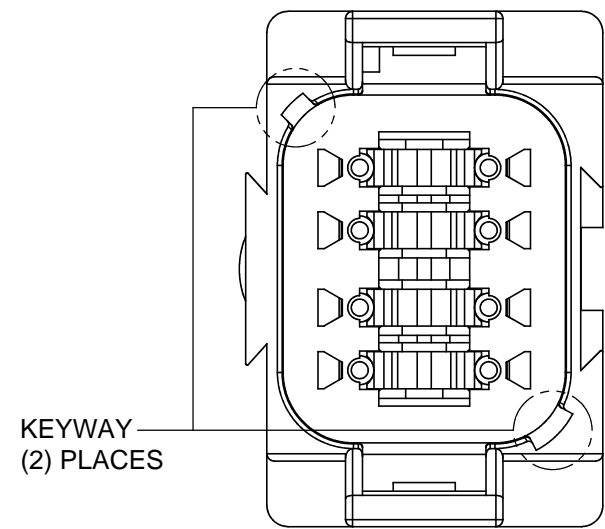

KEY-C CONFIGURATION	
COLOR	PART NUMBER
GREY	AT04-08PC-SRGRY
BLACK	AT04-08PC-SRBK
* GREEN	AT04-08PC-SRGN
BROWN	AT04-08PC-SRBR

P/N AT04-08PD-SRBR
KEY-D CONFIGURATION
STANDARD COLOR: BROWN

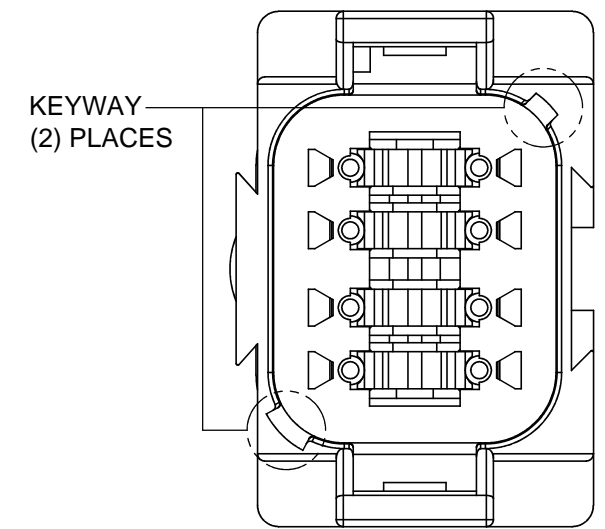

KEY-D CONFIGURATION	
COLOR	PART NUMBER
GREY	AT04-08PD-SRGRY
BLACK	AT04-08PD-SRBK
GREEN	AT04-08PD-SRGN
* BROWN	AT04-08PD-SRBR

NOTE:

AN ASTERISKS (*) PLACED BEFORE THE COLOR DENOTES THE STANDARD MOLDED COLOR OF THE CONNECTORS SHOWN ABOVE. STRAIN RELIEF END CAPS ARE AVAILABLE IN BLACK ONLY.



OTHER COLORS SHOWN ARE AVAILABLE VIA SPECIAL ORDER.



TITLE: RECEPTACLE, 8 PIN, AT SERIES, KEYED, STRAIN RELIEF END CAP
DWG NO.: AT04-08PX-SRXXX
REV: A3
SH: 2
OF: 2

QUANTITY	PART NUMBER	DESCRIPTION	ITEM												
MATERIALS LIST															
UNLESS OTHERWISE SPECIFIED 1) All dimensions are in metric(mm). 2) Tolerances are as follows: 1 PL DEC ±0.30 2 PL DEC ±0.15 3 PL DEC ±0.08 Fractions ±1/64 Angles ±1° 3) Note reference =		<table border="1"> <tr> <th>SIGNATURES</th> <th>DATE</th> </tr> <tr> <td>D.PARKS</td> <td>11DEC13</td> </tr> <tr> <td>CHECKED:</td> <td></td> </tr> <tr> <td>ENGINEER:</td> <td></td> </tr> <tr> <td>APPROVAL:</td> <td></td> </tr> <tr> <td>CUSTOMER:</td> <td></td> </tr> </table>		SIGNATURES	DATE	D.PARKS	11DEC13	CHECKED:		ENGINEER:		APPROVAL:		CUSTOMER:	
SIGNATURES	DATE														
D.PARKS	11DEC13														
CHECKED:															
ENGINEER:															
APPROVAL:															
CUSTOMER:															
MATERIAL SPECIFICATIONS:		<div style="text-align: center;"> <h1>Amphenol</h1> <p>Sine Systems - www.amphenol-sine.com 44724 Morley Drive Clinton Township, MI 48036</p> <p>RECEPTACLE, 8 PIN, AT SERIES, KEYED, STRAIN RELIEF END CAP</p> </div>													
PROCESS SPECIFICATIONS:															
NEXT ASSY:															
THIS DRAWING IS SUPPLIED FOR INFORMATION ONLY. DESIGN FEATURES, SPECIFICATIONS AND PERFORMANCE DATA SHOWN HEREON ARE THE PROPERTY OF THE AMPHENOL CORPORATION. NO RIGHTS OF REPRODUCTION ARE IMPLIED. ALL DIMENSIONS ARE SUBJECT TO NORMAL MANUFACTURING VARIATIONS.		<table border="1"> <tr> <th>SIZE</th> <th>TYPE</th> <th>DWG NO.</th> <th>REVISION</th> </tr> <tr> <td>B</td> <td>C-</td> <td>AT04-08PX-SRXXX</td> <td>A3</td> </tr> </table>	SIZE	TYPE	DWG NO.	REVISION	B	C-	AT04-08PX-SRXXX	A3					
SIZE	TYPE	DWG NO.	REVISION												
B	C-	AT04-08PX-SRXXX	A3												
SCALE: NONE		SHEET 2 OF 2													



AT Series™ - Contact Size 16 Options

Machined Contacts, Sockets & Pins				
Part Number	Description	Size	AWG	Type
AT60-215-1631	Male Contact - Pin, Gold-plated	16	14	Machined
AT62-209-1631	Female Contact - Socket, Gold-plated	16	14	Machined
AT60-215-16141	Male Contact - Pin, Nickel-plated	16	14	Machined
AT62-209-16141	Female Contact - Socket, Nickel-plated	16	14	Machined
AT60-202-1631	Male Contact - Pin, Gold-plated	16	16-20	Machined
AT62-201-1631	Female Contact - Socket, Gold-plated	16	16-20	Machined
AT60-202-16141	Male Contact - Pin, Nickel-plated	16	16-20	Machined
AT62-201-16141	Female Contact - Socket, Nickel-plated	16	16-20	Machined
AT60-202-1631-22	Male Contact - Pin, Gold-plated	16	22-24	Machined
AT62-201-1631-22	Female Contact - Socket, Gold-plated	16	22-24	Machined
AT60-202-16141-22	Male Contact - Pin, Nickel-plated	16	22-24	Machined
AT62-201-16141-22	Female Contact - Socket, Nickel-plated	16	22-24	Machined

Tooling - Machined Contacts		
Part	Part Number	Description
	CA-5D12	Universal Hand Crimp Tool, Size 12/16/20 (Machined contacts only)
	CA-5E12	Pneumatic Crimp Tool, Size 12/16/20 (Machined contacts only)

Contact Removal Tools		
Part	Part Number	Description
	ATRT-100	Used for removal of contacts for A Series™ products
	AT11-310-1605	Contact Removal Tool, Plastic, Size 16
	A114017	Sealing Plug, Size 16, White

Stamped & Formed Contacts, Sockets & Pins				
Part Number	Description	Size	AWG	Type
AT60-14-0144	Male Contact - Pin, Gold-plated	16	14-16	Stamped & Formed
AT62-14-0144	Female Contact - Socket, Gold-plated	16	14-16	Stamped & Formed
AT60-14-0122	Male Contact - Pin, Nickel-plated	16	14-16	Stamped & Formed
AT62-14-0122	Female Contact - Socket, Nickel-plated	16	14-16	Stamped & Formed
AT60-16-0144	Male Contact - Pin, Gold-plated	16	16-18	Stamped & Formed
AT62-16-0144	Female Contact - Socket, Gold-plated	16	16-18	Stamped & Formed
AT60-16-0122	Male Contact - Pin, Nickel-plated	16	16-18	Stamped & Formed
AT62-16-0122	Female Contact - Socket, Nickel-plated	16	16-18	Stamped & Formed
AT60-16-0644	Male Contact - Pin, Gold-plated	16	18-20	Stamped & Formed
AT62-16-0644	Female Contact - Socket, Gold-plated	16	18-20	Stamped & Formed
AT60-16-0622	Male Contact - Pin, Nickel-plated	16	18-20	Stamped & Formed
AT62-16-0622	Female Contact - Socket, Nickel-plated	16	18-20	Stamped & Formed
AT60-16-0844	Male Contact - Pin, Gold-plated	16	20-22	Stamped & Formed
AT62-16-0844	Female Contact - Socket, Gold-plated	16	20-22	Stamped & Formed
AT60-16-0822	Male Contact - Pin, Nickel-plated	16	20-22	Stamped & Formed
AT62-16-0822	Female Contact - Socket, Nickel-plated	16	20-22	Stamped & Formed

Tooling - Stamped & Formed Contacts		
Part	Part Number	Description
	MFX-3950	Crimp Die - Size 16, 18-20AWG (S&F contacts only)
	MFX-3953	Crimp Die - Size 16, 16-18AWG (S&F contacts only)
	MFX-3975	Crimp Die - Size 16, 14-16AWG (S&F contacts only)
	MFX-3990	Crimp Die - Size 16, 20-22AWG (S&F contacts only)
	ATT-16-00	Hand Crimp Tool - Size 16, 14-16AWG (S&F contacts only)
	ATT-16-01	Hand Crimp Tool - Size 16, 18-20AWG (S&F contacts only)
	ATT-1612-03	Hand Crimp Tool - Size 16, 20-22AWG (S&F contacts only)

Amphenol Sine Systems
 44724 Morley Drive
 Clinton Township, MI 48036 USA
www.amphenol-sine.com
 09/2021