

Product Brief for

RAK5205 WisTrio LoRa Tracker

WisDevice RAK52xx Series

LoRa Development board

Version V2.01 | April 2019



WisTrio LoRa Tracker
RAK5205



www.RAKwireless.com

Visit our website for more detailed information

7 PAGES



Table of Contents

1. Overview	3
1.1 Introduction to the board	3
1.2 Ports, jumpers, etc.	4
1.3 Functional Diagram and Header Pinout.....	5
2. Contact Information	6
3. Revision History	7
4. Document Summary	7

1. Overview

1.1 Introduction to the board

The RAK5205 LoRa Tracker is a board based on the RAK811 (SX1276 by Semtech built-in). At its core it runs an STM32L1 microcontroller. Additionally there is onboard GPS and several sensors built-in.

The board is especially suitable for rapid development of applications such as: asset tracking, Vehicle management, location-based services, etc. The process of connecting it to TTN/Cayenne via the nearest gateway is straightforward and quick. Developing for various use cases is a quick and easy, the board is especially suited for power constraint scenarios as its energy consumption is very low. It is easy to program and control via the built in AT commands ([AT command control manual](#)).

In short the board integrates the following components:

- ◆ RAK811 (Built-in Semtech SX1276/78) for LoRa connectivity
- ◆ 96Boards Compatible form factor and 30 pin header
- ◆ Ublox Max 7Q GPS Module
- ◆ BME680 Temperature, Humidity, Air Pressure, Gas
- ◆ LIS3DH 3-axis MEMS sensor (accelerometer)
- ◆ Support for Battery and Solar power operation
- ◆ Sleep mode consumption down to 14.6uA
- ◆ Custom AT command firmware
- ◆ Packet includes Micro USB cable for power and programming, LoRa Antenna (SMA or iPEX), DuPont Lines (for easy connection to the GPIO header), GPS Antenna (SMA or iPEX)

1.2 Ports, jumpers, etc.

Looking at Figure we can identify the following:

- ◆ The Two antenna connectors on the right (SMA or iPEX options are available)
- ◆ 30 pin header on top
- ◆ Micro USB port, status LED and the Charging mode jumper
- ◆ Bottom left to right: Battery connector, Solar Charger connector, Boot mode jumper on top of UART jumper, Reset button and the Ublox Max 7Q GPS module
- ◆ On the back there are the sensors (LIS3DH accelerometer and BME680 environmental)
- ◆ The position of the jumpers needs to be changed for the different operation modes, which will be discussed further down in the corresponding parts of the guide

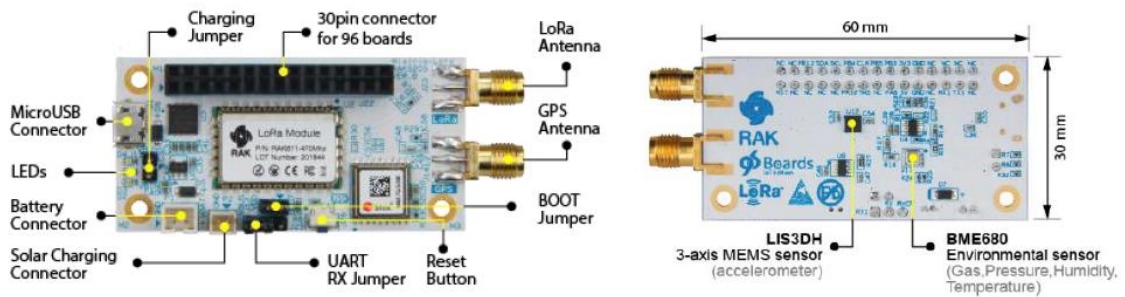

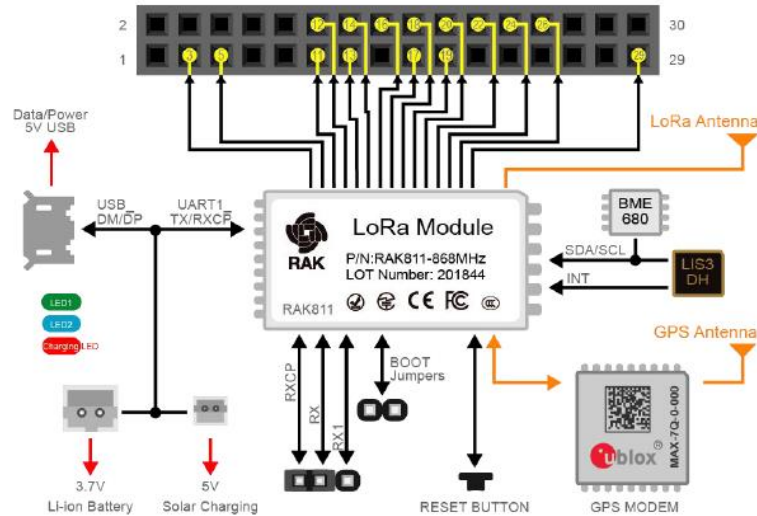

1.3 Functional Diagram and Header Pinout





Pin Number	Pin Name	Description
1-2	NC	Not Connected
3	UART1_TX	UART1 TX
4	NC	Not Connected
5	UART1_RX	In order to use the UART1 interface you need to short the middle and right pin (antenna side) via J25
6-8	NC	Not Connected
9-10	GND	Ground
11	VCC _{IN}	5V Output
12	VCC _{3V3}	3.3V Output
12	PA8	GPIO
14	PB3	GPIO
15	NC	Not Connected
16	PB5	GPIO
17	SWED_TMS	GPIO / R21, R22 10K pull-up resistor can be used as a JTAG
18	SWD_CLK	
19	LED1_PA12	GPIO
20	LED2_PB4	GPIO
21	NC	Not Connected
22	SCL	I2C Clock Line
23	NC	Not Connected
24	SDA	I2C Data Line
25	NC	Not Connected
26	PB12	ADC (Analog to Digital Converter)
27-28	NC	Not Connected
29	RST	Reset Pin
30	NC	Not Connected

2. Contact Information

Shenzhen Business

-  ken.yu@rakwireless.com
-  Room 506, Bldg B, New Compark, Pingshan First Road, Taoyuan Street, Nanshan District, Shenzhen

Shenzhen Technical

-  steven.tang@rakwireless.com
-  0755-86108311
-  Room 506, Bldg B, New Compark, Pingshan First Road, Taoyuan Street, Nanshan District, Shenzhen

3. Revision History

Revision	Description	Date
1.0	Initial version	2019-04-05
1.1	Added Functional Diagram and Pinout	2019-04-16

4. Document Summary

Document Name: RAK5205 Product Brief
Product Name: RAK5205 WisTrio LoRa
Release Date: April 2019
Revision Number: V1.1

Prepared by	Checked by:	Approved by:
Vladislav & Todor	Fomi	



About RAKwireless:

RAKwireless is the pioneer in providing innovative and diverse cellular and LoRa connectivity solutions for IoT edge devices. It's easy and modular design can be used in different IoT applications and accelerate time-to-market.

For more information, please visit RAKwireless website at www.rakwireless.com.