



# Product Change Notification

## TE Connectivity

Product Change Notification: P-22-021992

PCN Date: 13-JAN-22

TE would like to inform you of the following change(s) to the listed TE Connectivity Product. In case of any further questions about this change(s), please contact your TE Connectivity Sales Engineer. Affected part, drawing and/or specification numbers are listed on the attached sheet(s).

**General Product Description:**  
Thick Film Power Resistor - Type MPT Series

**Description of Changes**  
MPT20 Series End of Line  
**Other attachments:**  
[New Datasheet](#)

**Reason for Changes:**  
New specification. In line with TE strategic focus and portfolio management it has been decided that due to lack of market interest we will no longer offer the MPT20 model. All other models remain available. See attached updated datasheet for full details. This PCN raised to distribute new datasheet to existing customers.

Estimated Dates:	
Last Order Date (Obsolete Parts Only):	First Date To Ship (Changed Parts Only):
Last Ship Date (Obsolete Parts Only):	Last Date for Mixed Shipments: (Changed Parts Only):
	No Mixed Shipments

**Part Number(s) being Modified:**

Part Number	Part Discontinued per PCN	Customer Drawing	Customer Part Number	Alias Part Number(s)	Substitute Part Number	Substitute Alias Part Number(s)	Description Of Difference
<a href="#">1-2176429-0</a>	NO			"MPT100A3R3J"			
<a href="#">1-2176429-1</a>	NO			"MPT100A4R7J"			
<a href="#">1-2176429-2</a>	NO			"MPT100A6R8J"			
<a href="#">1-2176429-3</a>	NO			"MPT100A10RJ"			
<a href="#">1-2176429-4</a>	NO			"MPT100C15RJ"			
<a href="#">1-2176429-5</a>	NO			"MPT100C22RJ"			
<a href="#">1-2176429-6</a>	NO			"MPT100C33RJ"			
<a href="#">1-2176429-7</a>	NO			"MPT100C47RJ"			
<a href="#">1-2176429-8</a>	NO			"MPT100C68RJ"			
<a href="#">1-2176429-9</a>	NO			"MPT100C100RJ"			
<a href="#">1-2176430-0</a>	NO			"MPT35A3R3J"			
<a href="#">1-2176430-1</a>	NO			"MPT35A4R7J"			
<a href="#">1-2176430-2</a>	NO			"MPT35A6R8J"			
<a href="#">1-2176430-3</a>	NO			"MPT35A10RJ"			
<a href="#">1-2176430-5</a>	NO			"MPT35C22RJ"			
<a href="#">1-2176430-6</a>	NO			"MPT35C33RJ"			
<a href="#">1-2176430-7</a>	NO			"MPT35C47RJ"			
<a href="#">1-2176430-8</a>	NO			"MPT35C68RJ"			
<a href="#">1-2176430-9</a>	NO			"MPT35C100RJ"			
<a href="#">2-2176429-0</a>	NO			"MPT100C150RJ"			
<a href="#">2-2176429-1</a>	NO			"MPT100C220RJ"			
<a href="#">2-2176429-2</a>	NO			"MPT100C330RJ"			
<a href="#">2-2176429-3</a>	NO			"MPT100C470RJ"			
<a href="#">2-2176429-4</a>	NO			"MPT100C680RJ"			
<a href="#">2-2176429-5</a>	NO			"MPT100C1K0J"			
<a href="#">2-2176429-6</a>	NO			"MPT100C1K5J"			
<a href="#">2-2176429-7</a>	NO			"MPT100C2K2J"			
<a href="#">2-2176429-8</a>	NO			"MPT100C3K3J"			
<a href="#">2-2176429-9</a>	NO			"MPT100C4K7J"			
<a href="#">2-2176430-0</a>	NO			"MPT35C150RJ"			
<a href="#">2-2176430-1</a>	NO			"MPT35C220RJ"			
<a href="#">2-2176430-2</a>	NO			"MPT35C330RJ"			

Part Number	Part Discontinued per PCN	Customer Drawing	Customer Part Number	Alias Part Number(s)	Substitute Part Number	Substitute Alias Part Number(s)	Description Of Difference
<a href="#">2-2176430-3</a>	NO			"MPT35C470RJ"			
<a href="#">2-2176430-4</a>	NO			"MPT35C680RJ"			
<a href="#">2-2176430-5</a>	NO			"MPT35C1K0J"			
<a href="#">2-2176430-6</a>	NO			"MPT35C1K5J"			
<a href="#">2-2176430-7</a>	NO			"MPT35C2K2J"			
<a href="#">2-2176430-8</a>	NO			"MPT35C3K3J"			
<a href="#">2-2176430-9</a>	NO			"MPT35C4K7J"			
<a href="#">2176429-1</a>	NO			"MPT100XR10J"			
<a href="#">2176429-2</a>	NO			"MPT100XR15J"			
<a href="#">2176429-3</a>	NO			"MPT100XR22J"			
<a href="#">2176429-4</a>	NO			"MPT100XR33J"			
<a href="#">2176429-5</a>	NO			"MPT100XR47J"			
<a href="#">2176429-6</a>	NO			"MPT100XR68J"			
<a href="#">2176429-7</a>	NO			"MPT100X1R0J"			
<a href="#">2176429-8</a>	NO			"MPT100T1R5J"			
<a href="#">2176429-9</a>	NO			"MPT100T2R2J"			
<a href="#">2176430-1</a>	NO			"MPT35XR10J"			
<a href="#">2176430-2</a>	NO			"MPT35XR15J"			
<a href="#">2176430-3</a>	NO			"MPT35XR22J"			
<a href="#">2176430-4</a>	NO			"MPT35XR33J"			
<a href="#">2176430-5</a>	NO			"MPT35XR47J"			
<a href="#">2176430-6</a>	NO			"MPT35XR68J"			
<a href="#">2176430-7</a>	NO			"MPT35A1R0J"			
<a href="#">2176430-8</a>	NO			"MPT35A1R5J"			
<a href="#">2176430-9</a>	NO			"MPT35A2R2J"			
<a href="#">3-2176429-0</a>	NO			"MPT100C6K8J"			
<a href="#">3-2176429-1</a>	NO			"MPT100C10KJ"			
<a href="#">3-2176429-2</a>	NO			"MPT100T1R2F"			
<a href="#">3-2176429-3</a>	NO			"MPT100T1R5F"			
<a href="#">3-2176429-4</a>	NO			"MPT100T1R8F"			
<a href="#">3-2176429-5</a>	NO			"MPT100T2R2F"			
<a href="#">3-2176429-6</a>	NO			"MPT100T2R7F"			
<a href="#">3-2176429-7</a>	NO			"MPT100A3R3F"			
<a href="#">3-2176429-8</a>	NO			"MPT100A3R9F"			
<a href="#">3-2176429-9</a>	NO			"MPT100A4R7F"			
<a href="#">3-2176430-0</a>	NO			"MPT35C6K8J"			
<a href="#">3-2176430-1</a>	NO			"MPT35C10KJ"			
<a href="#">3-2176430-2</a>	NO			"MPT35A1R0F"			
<a href="#">3-2176430-3</a>	NO			"MPT35A1R2F"			
<a href="#">3-2176430-4</a>	NO			"MPT35A1R5F"			
<a href="#">3-2176430-5</a>	NO			"MPT35A1R8F"			
<a href="#">3-2176430-6</a>	NO			"MPT35A2R2F"			
<a href="#">3-2176430-7</a>	NO			"MPT35A2R7F"			
<a href="#">3-2176430-8</a>	NO			"MPT35A3R3F"			
<a href="#">3-2176430-9</a>	NO			"MPT35A3R9F"			
<a href="#">4-2176429-0</a>	NO			"MPT100A5R6F"			
<a href="#">4-2176429-1</a>	NO			"MPT100A6R8F"			
<a href="#">4-2176429-2</a>	NO			"MPT100A8R2F"			
<a href="#">4-2176429-3</a>	NO			"MPT100A10RF"			
<a href="#">4-2176429-4</a>	NO			"MPT100C12RF"			
<a href="#">4-2176429-5</a>	NO			"MPT100C15RF"			
<a href="#">4-2176429-6</a>	NO			"MPT100C18RF"			
<a href="#">4-2176429-7</a>	NO			"MPT100C22RF"			
<a href="#">4-2176429-8</a>	NO			"MPT100C27RF"			
<a href="#">4-2176429-9</a>	NO			"MPT100C33RF"			
<a href="#">4-2176430-0</a>	NO			"MPT35A4R7F"			
<a href="#">4-2176430-1</a>	NO			"MPT35A5R6F"			
<a href="#">4-2176430-2</a>	NO			"MPT35A6R8F"			
<a href="#">4-2176430-3</a>	NO			"MPT35A8R2F"			
<a href="#">4-2176430-4</a>	NO			"MPT35A10RF"			
<a href="#">4-2176430-5</a>	NO			"MPT35C12RF"			
<a href="#">4-2176430-6</a>	NO			"MPT35C15RF"			
<a href="#">4-2176430-7</a>	NO			"MPT35C18RF"			
<a href="#">4-2176430-8</a>	NO			"MPT35C22RF"			
<a href="#">4-2176430-9</a>	NO			"MPT35C27RF"			

Part Number	Part Discontinued per PCN	Customer Drawing	Customer Part Number	Alias Part Number(s)	Substitute Part Number	Substitute Alias Part Number(s)	Description Of Difference
<a href="#">5-2176429-0</a>	NO			"MPT100C39RF"			
<a href="#">5-2176429-1</a>	NO			"MPT100C47RF"			
<a href="#">5-2176429-2</a>	NO			"MPT100C56RF"			
<a href="#">5-2176429-3</a>	NO			"MPT100C68RF"			
<a href="#">5-2176429-4</a>	NO			"MPT100C82RF"			
<a href="#">5-2176429-5</a>	NO			"MPT100C100RF"			
<a href="#">5-2176429-6</a>	NO			"MPT100C120RF"			
<a href="#">5-2176429-7</a>	NO			"MPT100C150RF"			
<a href="#">5-2176429-8</a>	NO			"MPT100C180RF"			
<a href="#">5-2176429-9</a>	NO			"MPT100C220RF"			
<a href="#">5-2176430-0</a>	NO			"MPT35C33RF"			
<a href="#">5-2176430-1</a>	NO			"MPT35C39RF"			
<a href="#">5-2176430-2</a>	NO			"MPT35C47RF"			
<a href="#">5-2176430-3</a>	NO			"MPT35C56RF"			
<a href="#">5-2176430-4</a>	NO			"MPT35C68RF"			
<a href="#">5-2176430-5</a>	NO			"MPT35C82RF"			
<a href="#">5-2176430-6</a>	NO			"MPT35C100RF"			
<a href="#">5-2176430-7</a>	NO			"MPT35C120RF"			
<a href="#">5-2176430-8</a>	NO			"MPT35C150RF"			
<a href="#">5-2176430-9</a>	NO			"MPT35C180RF"			
<a href="#">6-2176429-0</a>	NO			"MPT100C270RF"			
<a href="#">6-2176429-1</a>	NO			"MPT100C330RF"			
<a href="#">6-2176429-2</a>	NO			"MPT100C390RF"			
<a href="#">6-2176429-3</a>	NO			"MPT100C470RF"			
<a href="#">6-2176429-4</a>	NO			"MPT100C560RF"			
<a href="#">6-2176429-5</a>	NO			"MPT100C680RF"			
<a href="#">6-2176429-6</a>	NO			"MPT100C820RF"			
<a href="#">6-2176429-7</a>	NO			"MPT100C1K0F"			
<a href="#">6-2176429-8</a>	NO			"MPT100C1K2F"			
<a href="#">6-2176429-9</a>	NO			"MPT100C1K5F"			
<a href="#">6-2176430-0</a>	NO			"MPT35C220RF"			
<a href="#">6-2176430-1</a>	NO			"MPT35C270RF"			
<a href="#">6-2176430-2</a>	NO			"MPT35C330RF"			
<a href="#">6-2176430-3</a>	NO			"MPT35C390RF"			
<a href="#">6-2176430-4</a>	NO			"MPT35C470RF"			
<a href="#">6-2176430-5</a>	NO			"MPT35C560RF"			
<a href="#">6-2176430-6</a>	NO			"MPT35C680RF"			
<a href="#">6-2176430-7</a>	NO			"MPT35C820RF"			
<a href="#">6-2176430-8</a>	NO			"MPT35C1K0F"			
<a href="#">6-2176430-9</a>	NO			"MPT35C1K2F"			
<a href="#">7-2176429-0</a>	NO			"MPT100C1K8F"			
<a href="#">7-2176429-1</a>	NO			"MPT100C2K2F"			
<a href="#">7-2176429-2</a>	NO			"MPT100C2K7F"			
<a href="#">7-2176429-3</a>	NO			"MPT100C3K3F"			
<a href="#">7-2176429-4</a>	NO			"MPT100C3K9F"			
<a href="#">7-2176429-5</a>	NO			"MPT100C4K7F"			
<a href="#">7-2176429-6</a>	NO			"MPT100C5K6F"			
<a href="#">7-2176429-7</a>	NO			"MPT100C6K8F"			
<a href="#">7-2176429-8</a>	NO			"MPT100C8K2F"			
<a href="#">7-2176429-9</a>	NO			"MPT100C10KF"			
<a href="#">7-2176430-0</a>	NO			"MPT35C1K5F"			
<a href="#">7-2176430-1</a>	NO			"MPT35C1K8F"			
<a href="#">7-2176430-2</a>	NO			"MPT35C2K2F"			
<a href="#">7-2176430-3</a>	NO			"MPT35C2K7F"			
<a href="#">7-2176430-4</a>	NO			"MPT35C3K3F"			
<a href="#">7-2176430-5</a>	NO			"MPT35C3K9F"			
<a href="#">7-2176430-6</a>	NO			"MPT35C4K7F"			
<a href="#">7-2176430-7</a>	NO			"MPT35C5K6F"			
<a href="#">7-2176430-8</a>	NO			"MPT35C6K8F"			
<a href="#">7-2176430-9</a>	NO			"MPT35C8K2F"			
<a href="#">8-2176430-0</a>	NO			"MPT35C10KF"			

## Part Number(s) being Modified:

Part Number	Part Discontinued per PCN	Customer Drawing	Customer Part Number	Alias Part Number(s)	Substitute Part Number	Substitute Alias Part Number(s)	Description Of Difference
<a href="#">1-2176429-0</a>	NO			"MPT100A3R3J"			
<a href="#">1-2176429-1</a>	NO			"MPT100A4R7J"			
<a href="#">1-2176429-2</a>	NO			"MPT100A6R8J"			
<a href="#">1-2176429-3</a>	NO			"MPT100A10RJ"			
<a href="#">1-2176429-4</a>	NO			"MPT100C15RJ"			
<a href="#">1-2176429-5</a>	NO			"MPT100C22RJ"			
<a href="#">1-2176429-6</a>	NO			"MPT100C33RJ"			
<a href="#">1-2176429-7</a>	NO			"MPT100C47RJ"			
<a href="#">1-2176429-8</a>	NO			"MPT100C68RJ"			
<a href="#">1-2176429-9</a>	NO			"MPT100C100RJ"			
<a href="#">1-2176430-0</a>	NO			"MPT35A3R3J"			
<a href="#">1-2176430-1</a>	NO			"MPT35A4R7J"			
<a href="#">1-2176430-2</a>	NO			"MPT35A6R8J"			
<a href="#">1-2176430-3</a>	NO			"MPT35A10RJ"			
<a href="#">1-2176430-5</a>	NO			"MPT35C22RJ"			
<a href="#">1-2176430-6</a>	NO			"MPT35C33RJ"			
<a href="#">1-2176430-7</a>	NO			"MPT35C47RJ"			
<a href="#">1-2176430-8</a>	NO			"MPT35C68RJ"			
<a href="#">1-2176430-9</a>	NO			"MPT35C100RJ"			
<a href="#">2-2176429-0</a>	NO			"MPT100C150RJ"			
<a href="#">2-2176429-1</a>	NO			"MPT100C220RJ"			
<a href="#">2-2176429-2</a>	NO			"MPT100C330RJ"			
<a href="#">2-2176429-3</a>	NO			"MPT100C470RJ"			
<a href="#">2-2176429-4</a>	NO			"MPT100C680RJ"			
<a href="#">2-2176429-5</a>	NO			"MPT100C1K0J"			
<a href="#">2-2176429-6</a>	NO			"MPT100C1K5J"			
<a href="#">2-2176429-7</a>	NO			"MPT100C2K2J"			
<a href="#">2-2176429-8</a>	NO			"MPT100C3K3J"			
<a href="#">2-2176429-9</a>	NO			"MPT100C4K7J"			
<a href="#">2-2176430-0</a>	NO			"MPT35C150RJ"			
<a href="#">2-2176430-1</a>	NO			"MPT35C220RJ"			
<a href="#">2-2176430-2</a>	NO			"MPT35C330RJ"			

Part Number	Part Discontinued per PCN	Customer Drawing	Customer Part Number	Alias Part Number(s)	Substitute Part Number	Substitute Alias Part Number(s)	Description Of Difference
<del>2-</del> 2176430-3	NO			"MPT35C470RJ"			
<del>2-</del> 2176430-4	NO			"MPT35C680RJ"			
<del>2-</del> 2176430-5	NO			"MPT35C1K0J"			
<del>2-</del> 2176430-6	NO			"MPT35C1K5J"			
<del>2-</del> 2176430-7	NO			"MPT35C2K2J"			
<del>2-</del> 2176430-8	NO			"MPT35C3K3J"			
<del>2-</del> 2176430-9	NO			"MPT35C4K7J"			
<del>2176429-1</del>	NO			"MPT100XR10J"			
<del>2176429-2</del>	NO			"MPT100XR15J"			
<del>2176429-3</del>	NO			"MPT100XR22J"			
<del>2176429-4</del>	NO			"MPT100XR33J"			
<del>2176429-5</del>	NO			"MPT100XR47J"			
<del>2176429-6</del>	NO			"MPT100XR68J"			
<del>2176429-7</del>	NO			"MPT100X1R0J"			
<del>2176429-8</del>	NO			"MPT100T1R5J"			
<del>2176429-9</del>	NO			"MPT100T2R2J"			
<del>2176430-1</del>	NO			"MPT35XR10J"			
<del>2176430-2</del>	NO			"MPT35XR15J"			
<del>2176430-3</del>	NO			"MPT35XR22J"			
<del>2176430-4</del>	NO			"MPT35XR33J"			
<del>2176430-5</del>	NO			"MPT35XR47J"			
<del>2176430-6</del>	NO			"MPT35XR68J"			
<del>2176430-7</del>	NO			"MPT35A1R0J"			
<del>2176430-8</del>	NO			"MPT35A1R5J"			
<del>2176430-9</del>	NO			"MPT35A2R2J"			
<del>3-</del> 2176429-0	NO			"MPT100C6K8J"			
<del>3-</del> 2176429-1	NO			"MPT100C10KJ"			
<del>3-</del> 2176429-2	NO			"MPT100T1R2F"			
<del>3-</del> 2176429-3	NO			"MPT100T1R5F"			
<del>3-</del> 2176429-4	NO			"MPT100T1R8F"			
<del>3-</del> 2176429-5	NO			"MPT100T2R2F"			
<del>3-</del> 2176429-6	NO			"MPT100T2R7F"			
<del>3-</del> 2176429-7	NO			"MPT100A3R3F"			
<del>3-</del> 2176429-8	NO			"MPT100A3R9F"			
<del>3-</del> 2176429-9	NO			"MPT100A4R7F"			
<del>3-</del> 2176430-0	NO			"MPT35C6K8J"			
<del>3-</del> 2176430-1	NO			"MPT35C10KJ"			
<del>3-</del> 2176430-2	NO			"MPT35A1R0F"			
<del>3-</del> 2176430-3	NO			"MPT35A1R2F"			
<del>3-</del> 2176430-4	NO			"MPT35A1R5F"			
<del>3-</del> 2176430-5	NO			"MPT35A1R8F"			
<del>3-</del> 2176430-6	NO			"MPT35A2R2F"			

Part Number	Part Discontinued per PCN	Customer Drawing	Customer Part Number	Alias Part Number(s)	Substitute Part Number	Substitute Alias Part Number(s)	Description Of Difference
<a href="#">3-2176430-7</a>	NO			"MPT35A2R7F"			
<a href="#">3-2176430-8</a>	NO			"MPT35A3R3F"			
<a href="#">3-2176430-9</a>	NO			"MPT35A3R9F"			
<a href="#">4-2176429-0</a>	NO			"MPT100A5R6F"			
<a href="#">4-2176429-1</a>	NO			"MPT100A6R8F"			
<a href="#">4-2176429-2</a>	NO			"MPT100A8R2F"			
<a href="#">4-2176429-3</a>	NO			"MPT100A10RF"			
<a href="#">4-2176429-4</a>	NO			"MPT100C12RF"			
<a href="#">4-2176429-5</a>	NO			"MPT100C15RF"			
<a href="#">4-2176429-6</a>	NO			"MPT100C18RF"			
<a href="#">4-2176429-7</a>	NO			"MPT100C22RF"			
<a href="#">4-2176429-8</a>	NO			"MPT100C27RF"			
<a href="#">4-2176429-9</a>	NO			"MPT100C33RF"			
<a href="#">4-2176430-0</a>	NO			"MPT35A4R7F"			
<a href="#">4-2176430-1</a>	NO			"MPT35A5R6F"			
<a href="#">4-2176430-2</a>	NO			"MPT35A6R8F"			
<a href="#">4-2176430-3</a>	NO			"MPT35A8R2F"			
<a href="#">4-2176430-4</a>	NO			"MPT35A10RF"			
<a href="#">4-2176430-5</a>	NO			"MPT35C12RF"			
<a href="#">4-2176430-6</a>	NO			"MPT35C15RF"			
<a href="#">4-2176430-7</a>	NO			"MPT35C18RF"			
<a href="#">4-2176430-8</a>	NO			"MPT35C22RF"			
<a href="#">4-2176430-9</a>	NO			"MPT35C27RF"			
<a href="#">5-2176429-0</a>	NO			"MPT100C39RF"			
<a href="#">5-2176429-1</a>	NO			"MPT100C47RF"			
<a href="#">5-2176429-2</a>	NO			"MPT100C56RF"			
<a href="#">5-2176429-3</a>	NO			"MPT100C68RF"			
<a href="#">5-2176429-4</a>	NO			"MPT100C82RF"			
<a href="#">5-2176429-5</a>	NO			"MPT100C100RF"			
<a href="#">5-2176429-6</a>	NO			"MPT100C120RF"			
<a href="#">5-2176429-7</a>	NO			"MPT100C150RF"			
<a href="#">5-2176429-8</a>	NO			"MPT100C180RF"			
<a href="#">5-2176429-9</a>	NO			"MPT100C220RF"			

Part Number	Part Discontinued per PCN	Customer Drawing	Customer Part Number	Alias Part Number(s)	Substitute Part Number	Substitute Alias Part Number(s)	Description Of Difference
<a href="#">5-2176430-0</a>	NO			"MPT35C33RF"			
<a href="#">5-2176430-1</a>	NO			"MPT35C39RF"			
<a href="#">5-2176430-2</a>	NO			"MPT35C47RF"			
<a href="#">5-2176430-3</a>	NO			"MPT35C56RF"			
<a href="#">5-2176430-4</a>	NO			"MPT35C68RF"			
<a href="#">5-2176430-5</a>	NO			"MPT35C82RF"			
<a href="#">5-2176430-6</a>	NO			"MPT35C100RF"			
<a href="#">5-2176430-7</a>	NO			"MPT35C120RF"			
<a href="#">5-2176430-8</a>	NO			"MPT35C150RF"			
<a href="#">5-2176430-9</a>	NO			"MPT35C180RF"			
<a href="#">6-2176429-0</a>	NO			"MPT100C270RF"			
<a href="#">6-2176429-1</a>	NO			"MPT100C330RF"			
<a href="#">6-2176429-2</a>	NO			"MPT100C390RF"			
<a href="#">6-2176429-3</a>	NO			"MPT100C470RF"			
<a href="#">6-2176429-4</a>	NO			"MPT100C560RF"			
<a href="#">6-2176429-5</a>	NO			"MPT100C680RF"			
<a href="#">6-2176429-6</a>	NO			"MPT100C820RF"			
<a href="#">6-2176429-7</a>	NO			"MPT100C1K0F"			
<a href="#">6-2176429-8</a>	NO			"MPT100C1K2F"			
<a href="#">6-2176429-9</a>	NO			"MPT100C1K5F"			
<a href="#">6-2176430-0</a>	NO			"MPT35C220RF"			
<a href="#">6-2176430-1</a>	NO			"MPT35C270RF"			
<a href="#">6-2176430-2</a>	NO			"MPT35C330RF"			
<a href="#">6-2176430-3</a>	NO			"MPT35C390RF"			
<a href="#">6-2176430-4</a>	NO			"MPT35C470RF"			
<a href="#">6-2176430-5</a>	NO			"MPT35C560RF"			
<a href="#">6-2176430-6</a>	NO			"MPT35C680RF"			
<a href="#">6-2176430-7</a>	NO			"MPT35C820RF"			
<a href="#">6-2176430-8</a>	NO			"MPT35C1K0F"			
<a href="#">6-2176430-9</a>	NO			"MPT35C1K2F"			
<a href="#">7-2176429-0</a>	NO			"MPT100C1K8F"			
<a href="#">7-2176429-1</a>	NO			"MPT100C2K2F"			
<a href="#">7-2176429-2</a>	NO			"MPT100C2K7F"			

Part Number	Part Discontinued per PCN	Customer Drawing	Customer Part Number	Alias Part Number(s)	Substitute Part Number	Substitute Alias Part Number(s)	Description Of Difference
<a href="#">Z- 2176429-3</a>	NO			"MPT100C3K3F"			
<a href="#">Z- 2176429-4</a>	NO			"MPT100C3K9F"			
<a href="#">Z- 2176429-5</a>	NO			"MPT100C4K7F"			
<a href="#">Z- 2176429-6</a>	NO			"MPT100C5K6F"			
<a href="#">Z- 2176429-7</a>	NO			"MPT100C6K8F"			
<a href="#">Z- 2176429-8</a>	NO			"MPT100C8K2F"			
<a href="#">Z- 2176429-9</a>	NO			"MPT100C10KF"			
<a href="#">Z- 2176430-0</a>	NO			"MPT35C1K5F"			
<a href="#">Z- 2176430-1</a>	NO			"MPT35C1K8F"			
<a href="#">Z- 2176430-2</a>	NO			"MPT35C2K2F"			
<a href="#">Z- 2176430-3</a>	NO			"MPT35C2K7F"			
<a href="#">Z- 2176430-4</a>	NO			"MPT35C3K3F"			
<a href="#">Z- 2176430-5</a>	NO			"MPT35C3K9F"			
<a href="#">Z- 2176430-6</a>	NO			"MPT35C4K7F"			
<a href="#">Z- 2176430-7</a>	NO			"MPT35C5K6F"			
<a href="#">Z- 2176430-8</a>	NO			"MPT35C6K8F"			
<a href="#">Z- 2176430-9</a>	NO			"MPT35C8K2F"			
<a href="#">8- 2176430-0</a>	NO			"MPT35C10KF"			



## Type MPT Series

### Key Features

**Small Size**  
TO220 and  
TO247

**Easy to mount**

**Isolated**  
**moulded case**

**Non Inductive**

**High Power –**  
**TO220 to 50W**  
**when**  
**mounted on**  
**suitable**  
**heatsink**

**TO247 to**  
**100W when**  
**mounted on**  
**suitable**  
**heatsink**

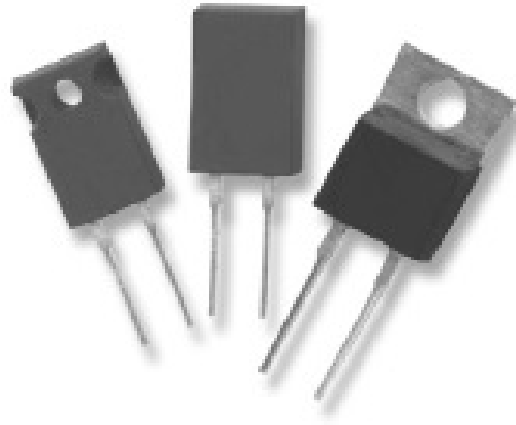

The MPT Resistor series are a range of TO220 and TO247 packaged, low inductance thick film power resistors. This small size, high power device with 5 models are ideally suited to applications where high power dissipation yet small size are key design requirements. The MPT Resistor series are the ideal solution for small snubber circuits, the output side of high speed pulse generators and low inductive resistor requirements in switch mode power supplies.

### Characteristics – Electrical

	MPT30	MPT35	MPT50
Package Size	TO220	TO220	TO220
Resistance Range	R05 ~ 100K	R05 ~ 10K	R10 ~ 10K
Rated Power (with Heatsink)	30W	35W	50W
Rated Power (in free air)	2.25W@25°C	2.5W@25°C	3W@25°C
Maximum Operating Voltage	420V	350V	350V
Dielectric Strength	1800VAC		
Insulation Resistance	10GΩ min.		
Operating Temperature	-65°C~150°C		

	MPT50H	MPT100
Package Size	TO220	TO247
Resistance Range	R10 ~ 10K	R05 ~ 100K
Rated Power (w / Heatsink)	50W	100W
Rated Power (in free air)	2.25W@25°C	3.5W@25°C
Maximum Operating Voltage	420V	700V
Dielectric Strength	1800VAC	
Insulation Resistance	10GΩ min.	
Operating Temperature	-65°C ~ 150°C	-65°C ~ 175°C

## TCR / Tolerance Value Chart

	0.5%	1%	5%	10%	TCR
MPT30	-	-	R05 ~ 1R0		Unspecified
		1R1 ~ 3R0		300PPM	
		3R3 ~ 10R		100PPM	
		11R ~ 100K		50PPM	
MPT35	-	-	R05 ~ R91		Unspecified
		1R0 ~ 10R		100PPM	
		11R ~ 10K		50PPM	
MPT50	-	1R0	R10 ~ 1R0		Unspecified
		1R1 ~ 3R0		300PPM	
		3R3 ~ 10R		100PPM	
		11R ~ 10K		50PPM	
MPT50H	-	1R0	R10 ~ 1R0		Unspecified
		1R1 ~ 3R0		300PPM	
		3R3 ~ 10R		100PPM	
		11R ~ 10K		50PPM	
MPT100	-	-	R05 ~ 1R0		Unspecified
		1R1 ~ 3R0		300PPM	
		3R3 ~ 10R		100PPM	
		11R ~ 100K		50PPM	

## Characteristics – Environmental

Test Item	Requirement	Test Method
Temperature Coefficient of Resistance (T.C.R.)	As Spec.	Referenced to 25°C, ΔR taken at +105°C
Short Time Overload	ΔR±0.3%	2 times rated power with applied voltage not to exceed 1.5 times Maximum continuous operating voltage for 5 seconds
Load Life	ΔR±1.0%	2,000 hours at rated power
Damp Heat with Load	ΔR±0.5%	40±2°C, 90~95% R.H., RCWV for 1000 hrs with 1.5 hrs "ON" and 0.5 hrs "OFF"
Solderability	90% min. coverage	245±5°C for 3 seconds
Thermal Shock	ΔR±0.3%	-65°C~150°C, 100 cycles
Terminal Strength	ΔR±0.2%	(Pull Test) 2.4N
Vibration, High Frequency	ΔR±0.2%	20g peak

Lead Material: Tinned Copper

For Models with fixing hole, maximum torque 0.9Nm

The Case Temperature is to be used for the Definition of the Applied Power Limit

The Case Temperature Measurement must be made with a Thermocouple Contacting the Center of the Component mounted on the Designed Heat Sink.

Thermal Grease should be Applied Properly

RCWV (Rated continuous working voltage)=  $V(P \cdot R)$  or Max. Operating voltage whichever is lower

### Derating Curve

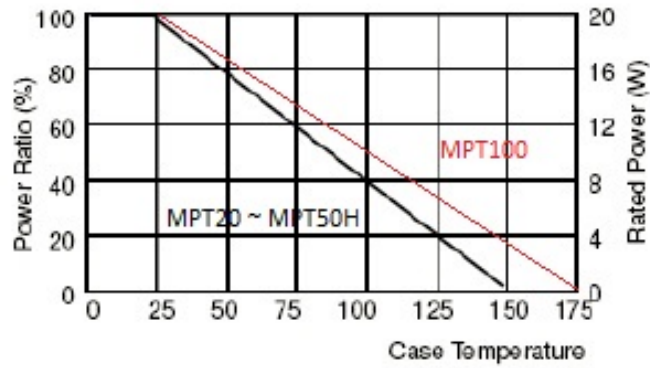

### Construction and dimensions

#### MPT30

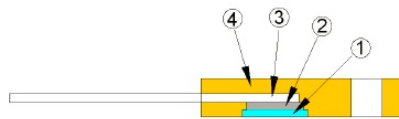

1	Alumina Substrate	3	Lead
2	Resistor Layer	4	Moulding

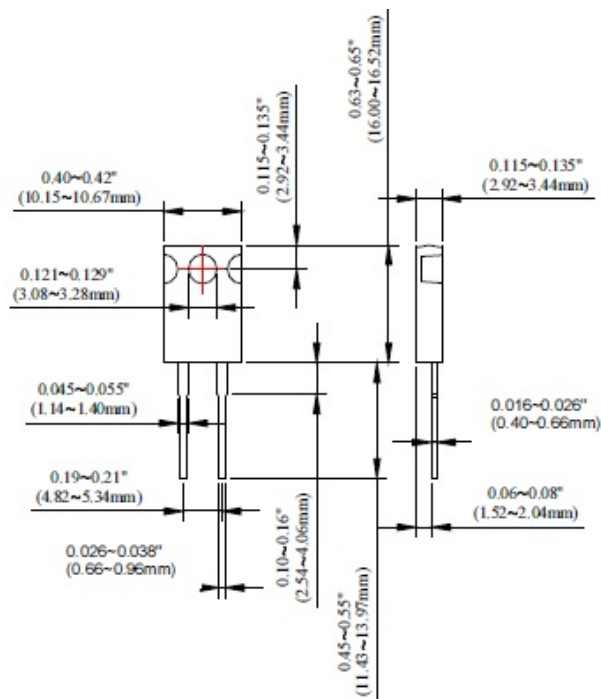

**MPT35**

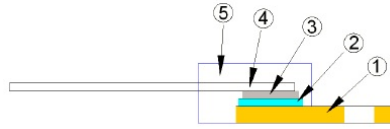

1	Flange	4	Lead
2	Alumina Substrate	5	Moulding
3	Resistor Layer		

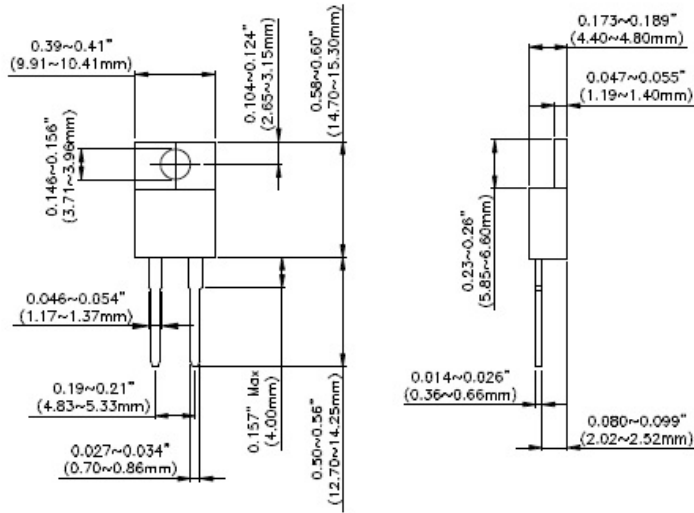

**MPT50**

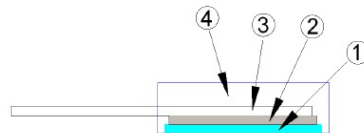

1	Alumina Substrate	3	Lead
2	Resistor Layer	4	Moulding

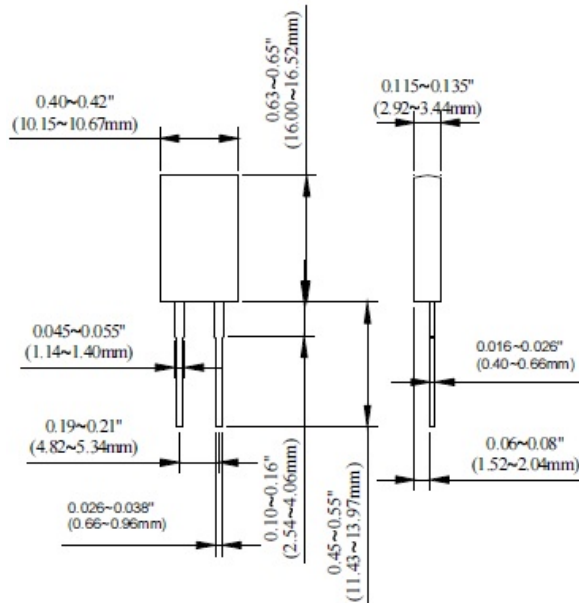

**MPT50H**

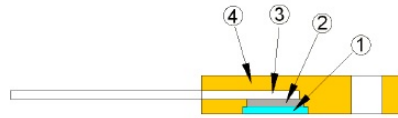

1	Alumina Substrate	3	Lead
2	Resistor Layer	4	Moulding

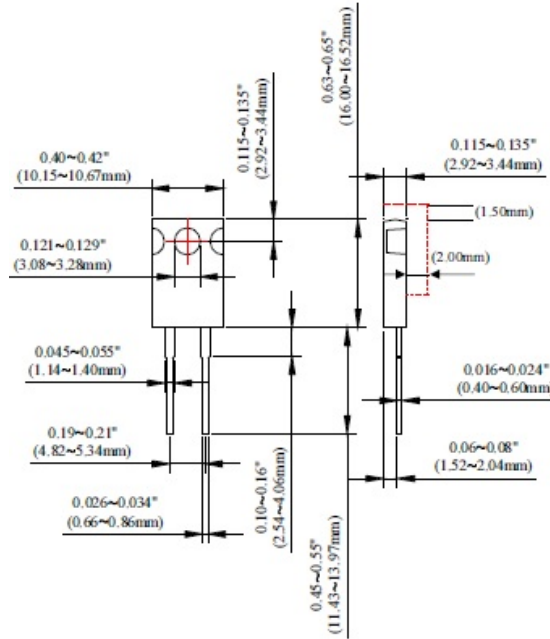

**MPT100**

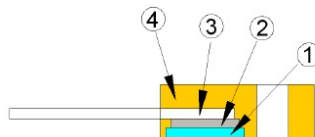

1	Alumina Substrate	3	Lead
2	Resistor Layer	4	Moulding

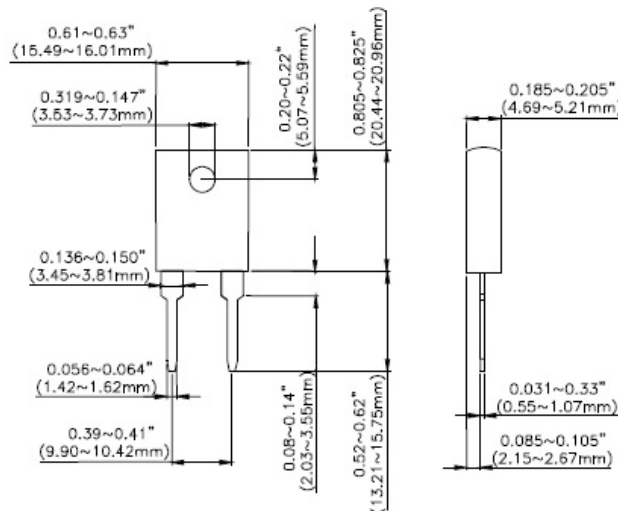

## Packaging

Model	Net Weight (1000 pieces)	Tube
MPT30	1155g	50 pieces
MPT35	1902g	50 pieces
MPT50	1290g	50 pieces
MPT50H	2770g	50 pieces
MPT100	3381g	35 pieces

## How To Order

MPT	35	C	100R	J
Common Part	Power Rating on Heatsink @25°C	Temp. Coefficient of Resistance	Resistance Value	Tolerance
MPT	30 – 30W 35 – 35W 50 – 50W 50H – 50W 100 – 100W	X – unspecified C – 50PPM A – 100PPM S – 200PPM T – 300PPM	0.1 ohm (100 milliohms) R10 1 ohm (1000 milliohms) 1R0 1K ohm (1000 ohm) 1K0	D - 0.5% F - 1% J - 5% K - 10%