

FEMALE PLUG M8 STRAIGHT TO MALE PLUG M8 STRAIGHT WSOR CABLES

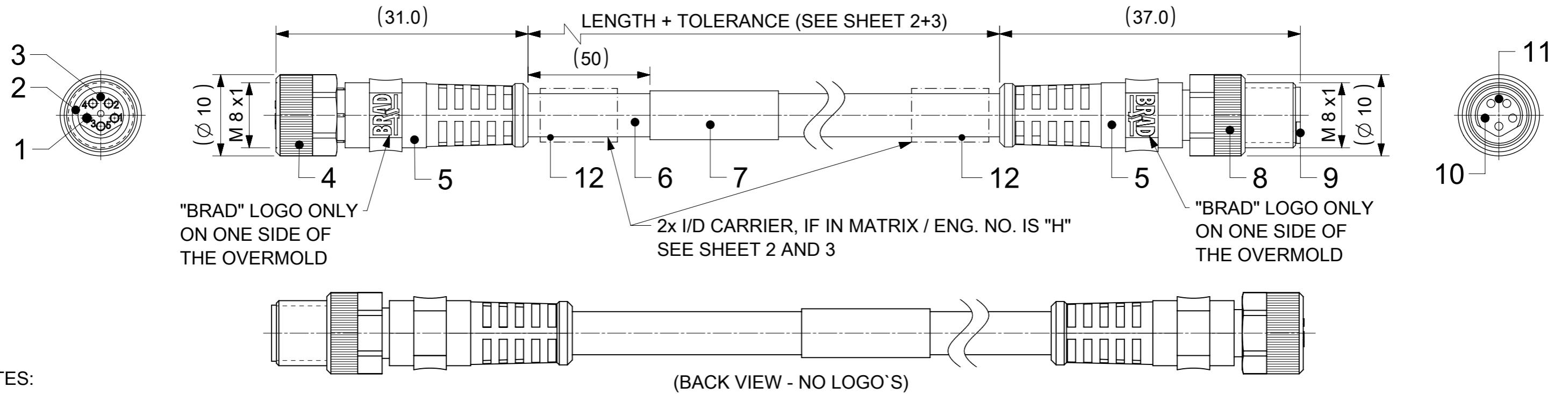

NOTES:

1. PRODUCT SPECIFICATION:

- RATED VOLTAGE: 3 contacts 60V AC/DC
4 and 5 contacts 30V AC/DC
- CURRENT RATING: 3, 4, 5 contacts 3A
- PROTECTION CLASS: IP 67
- TEMPERATURE: -25°C / +80°C

2. PACKAGING: THE CORDSETS ARE PACKED IN PLASTIC BAGS AND DELIVERED IN CARTON BOXES

3. SAFETY: INSTALLATION, MOUNTING, AND MAINTENANCE OF THE PRODUCT MAY ONLY BE CARRIED OUT BY A QUALIFIED ELECTRICIAN

CONTACTS POSITION FRONT VIEW:

	3 CONTACTS		4 CONTACTS		5 CONTACTS	
FEMALE						
MALE						
CONNECTIONS	PIN	WIRE	PIN	WIRE	PIN	WIRE
	1	BROWN	1	BROWN	1	BROWN
	3	BLUE	2	WHITE	2	WHITE
	4	BLACK	3	BLUE	3	BLUE
			4	BLACK	4	BLACK
				5	GREY	

FOR OPTIONS SEE - NUMERICAL CODE - ON SHEET 2

ITEM	QTY.	DESCRIPTION	MATERIAL	FINISH
12	2	I/D CARRIER	PVC	---
11	1	INSERT MALE BLACK	TPU	---
10	3 / 4 / 5	CONTACT M8 MALE	BRASS	SELECTIVE Au OVER Ni
9	1	SLEEVE	BRASS	NICKEL
8	1	COUPLING NUT M8 MALE SW9	BRASS	NICKEL
7	1	LABEL YELLOW	VINYL	---
6	-	CABLE	SEE SHEET 2	---
5	-	OVERMOLD BLACK	TPU	---
4	1	COUPLING NUT M8 FEMALE SW9	BRASS	NICKEL
3	1	INSERT FEMALE BLACK	TPU	---
2	1	O-RING RED	FKM	---
1	3 / 4 / 5	CONTACT M8 FEMALE	BRASS	SELECTIVE Au OVER Ni
ITEM	QTY.	DESCRIPTION	MATERIAL	FINISH

SYMBOLS	THIS DRAWING CONTAINS INFORMATION THAT IS PROPRIETARY TO MOLEX ELECTRONIC TECHNOLOGIES, LLC AND SHOULD NOT BE USED WITHOUT WRITTEN PERMISSION
▽ = 0	mm 2:1
▽ = 0	GENERAL TOLERANCES (UNLESS SPECIFIED)
▽ = 0	ANGULAR TOL ± 1.0°
▽ = 0	4 PLACES ±
▽ = 0	3 PLACES ±
▽ = 0	2 PLACES ± 0.05
▽ = 0	1 PLACE ± 0.3
▽ = 0	0 PLACES ± 0.5
■ = 0	DRAFT WHERE APPLICABLE MUST REMAIN WITHIN DIMENSIONS
▽ = 0	THIRD ANGLE PROJECTION

CURRENT REV DESC: NEW P/N'S ADDED		molex	
CSE M8 M8 XP AC BC FE STR WSOR MA STR XM			
PRODUCT CUSTOMER DRAWING		DOCUMENT NUMBER	DOC TYPE
1200878716		PSD	000
REVISION: A5		SHEET NUMBER	1 OF 3

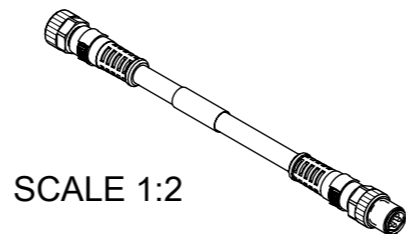

CODING ACCORDING TO IEC 61076-2-104

DOCUMENT STATUS	P1	RELEASE DATE	2021/12/07	06:44:43
-----------------	----	--------------	------------	----------

ENGINEERING NO. - NUMERICAL CODE (Available parts see PART LIST table. Other parts available upon request).

OPTIONS

4 4 X 0 3 0 B X X X X X X X

44=Nano-Change
M8x1
Double ended

Poles:
3=3 Contacts
4=4 Contacts
5=5 Contacts

Heads style:
030=Plug Female Straight
to Plug Male Straight

Cable type: See Table

Units:
M=Meter
C=Centimeter

Length
Examples:
005=0.5 unit
010=1 unit
100=10 unit

Overmold color:
Blank (Standard)=Black
H= 2 pcs. of
I/D Carrier PVC Transparent

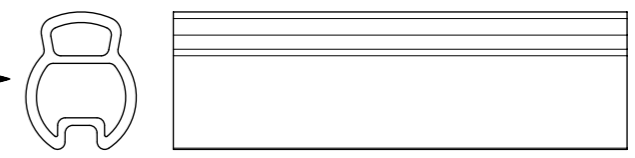

CABLE INFORMATION (for more information see Cable Data Sheet)

CABLE TYPE	NO. OF WIRES	CROSS SECTION	CABLE JACKET	UL	CSA	STATIC: TEMP. / BENDING RADIUS	DYNAMIC: TEMP. / BENDING RADIUS	DRAG CHAIN: TEMP. / BENDING RADIUS	DRAG CHAIN	CABLE PRODUCT SPECIFICATION	CABLE SPEC. DRAWING
B41	3 / 4 / 5	0.25mm ²	TPU Black	UL 21215/758	C22.2 I/II A/B 80°/600V	-40°C to +90°C 5xO.D.	-25°C to +80°C 7.5xO.D.	-5°C to +60°C 7.5xO.D.	up to 5 000 000 cycles at temp 20°C	1552200001	SD-120209-001
B55	3 / 4	0.34mm ²	TPU Yellow								n/a

CABLE LENGTH TOLERANCES

LENGTH	TOLERANCE
0m-1m	+40 mm
>1m-5m	+60 mm
>5m-10m	+80 mm
>10m-20m	+140 mm
>20m-30m	+160 mm
>30m	+1% length

SYMBOLS	THIS DRAWING CONTAINS INFORMATION THAT IS PROPRIETARY TO MOLEX ELECTRONIC TECHNOLOGIES, LLC AND SHOULD NOT BE USED WITHOUT WRITTEN PERMISSION	
	DIMENSION UNITS	SCALE
▽ = 0	mm	2:1
▽ = 0	GENERAL TOLERANCES (UNLESS SPECIFIED)	
▽ = 0	ANGULAR TOL ± 1.0°	
▽ = 0	4 PLACES ±	CURRENT REV DESC: NEW P/N'S ADDED
▽ = 0	3 PLACES ±	
▽ = 0	2 PLACES ± 0.05	
▽ = 0	1 PLACE ± 0.3	EC NO: 687807 DRWN: RSCHIEBER 2021/12/01 CHK'D: RSILLER 2021/12/07 APPR: RSILLER 2021/12/07
▽ = 0	0 PLACES ± 0.5	
▽ = 0	INITIAL REVISION: DRWN: JMARSZALEK 2016/09/13 APPR: RSILLER 2018/12/10	
□ = 0	DRAFT WHERE APPLICABLE MUST REMAIN WITHIN DIMENSIONS	
▽ = 0	THIRD ANGLE PROJECTION	DRAWING
		A3-SIZE
	SERIES	120087
	MATERIAL NUMBER	SEE SHEET 3
	CUSTOMER	GENERAL MARKET
	SHEET NUMBER	2 OF 3



CSE M8 M8 XP AC BC FE STR WSOR MA STR XM

PRODUCT CUSTOMER DRAWING

DOCUMENT NUMBER: 1200878716
DOC TYPE: PSD
DOC PART: 000
REVISION: A5









PART LIST

No.	Molex PN.	Engineering No.	Cable Length
1	1200878703	443030B41M006	0.6m
2	1200878704	443030B41M010	1m
3	1200878705	443030B41M020	2m
4	1200878706	443030B41M030	3m
5	1200878707	443030B41M050	5m
6	1200878708	443030B41M100	10m
7	1200878709	444030B41M006	0.6m
8	1200878710	444030B41M010	1m
9	1200878711	444030B41M020	2m
10	1200878712	444030B41M030	3m
11	1200878713	444030B41M050	5m
12	1200878714	444030B41M100	10m
13	1200878715	445030B41M006	0.6m
14	1200878716	445030B41M010	1m
15	1200878717	445030B41M020	2m
16	1200878718	445030B41M030	3m
17	1200878719	445030B41M050	5m
18	1200878720	445030B41M100	10m
19	1200878854	443030B41M005H	0.5m
20	1200878855	443030B41M010H	1m
21	1200878856	443030B41M020H	2m
22	1200878857	443030B41M030H	3m
23	1200878858	443030B41M050H	5m
24	1200878859	443030B41M100H	10m
25	1200878860	443030B41M150H	15m
26	1200878905	444030B41M005H	0.5m
27	1200878907	443030B41M200H	20m
28	1200878908	443030B41M250H	25m
29	1200878920	444030B55M020	2m
30	1200878921	444030B55M050	5m
31	1200878975	443030B41M070	7m
32	1200878976	443030B41M060	6m
33	1200878977	443030B41M080	8m
34	1200878972	444030B41M003	0.3m
35	1200878973	443030B41M150	15m

No.	Molex PN.	Engineering No.	Cable Length
36	1200878956	443030B41M015	1.5m
37	1200878974	443030B41M040	4m
38	1200879039	443030B41M025	2.5m
39	1200879040	444030B41M040	4m
40	1200879041	444030B41M080	8m
41			
42			
43			
44			
45			
46			
47			
48			
49			
50			
51			
52			
53			
54			
55			
56			
57			
58			
59			
60			
61			
62			
63			
64			
65			
66			
67			
68			
69			
70			

No.	Molex PN.	Engineering No.	Cable Length
71			
72			
73			
74			
75			
76			
77			
78			
79			
80			
81			
82			
83			
84			
85			
86			
87			
88			
89			
90			
91			
92			
93			
94			
95			
96			
97			
98			
99			
100			
101			
102			
103			
104			
105			

No.	Molex PN.	Engineering No.	Cable Length
106			
107			
108			
109			
110			
111			
112			
113			
114			
115			
116			
117			
118			
119			
120			
121			
122			
123			
124			
125			
126			
127			
128			
129			
130			
131			
132			
133			
134			
135			
136			
137			
138			
139			
140			

SYMBOLS  = 0  = 0  = 0  = 0  = 0  = 0  = 0  = 0	THIS DRAWING CONTAINS INFORMATION THAT IS PROPRIETARY TO MOLEX ELECTRONIC TECHNOLOGIES, LLC AND SHOULD NOT BE USED WITHOUT WRITTEN PERMISSION DIMENSION UNITS: mm SCALE: 1:1 GENERAL TOLERANCES (UNLESS SPECIFIED): ANGULAR TOL ± 1.0° 4 PLACES ± 3 PLACES ± 2 PLACES ± 0.05 1 PLACE ± 0.3 0 PLACES ± 0.5 DRAFT WHERE APPLICABLE MUST REMAIN WITHIN DIMENSIONS	CURRENT REV DESC: NEW P/N'S ADDED EC NO: 687807 DRWN: RSCHIEBER 2021/12/01 CHK'D: RSILLER 2021/12/07 APPR: RSILLER 2021/12/07 INITIAL REVISION: DRWN: JMARSZALEK 2016/09/13 APPR: RSILLER 2018/12/10 THIRD ANGLE PROJECTION	 CSE M8 M8 XP AC BC FE STR WSOR MA STR XM PRODUCT CUSTOMER DRAWING DOCUMENT NUMBER: 1200878716 DOC TYPE: PSD DOC PART: 000 REVISION: A5 MATERIAL NUMBER: SEE SHEET 3 CUSTOMER: GENERAL MARKET SHEET NUMBER: 3 OF 3	
	DRAWING: A3-SIZE SERIES: 120087			