



# LED Mini Wall Pack

## Mint Series



### Mint Series

Beyond LED's Mint Series Mini Wall Pack is the newest and the most unique product of 2021. The Mint Series Wall Pack is the smallest wall pack of its kind and offers high lumen efficacy. Utilizing highly reliable, high power LEDs to minimize energy usage while maximizing directed light distribution, it eliminates any upward illumination. Constructed with an aluminum housing, this fixture is sure to last for years. It is suitable for outdoor applications including warehouses, factories, restaurants, shopping areas and parks.

- Up to 125 lumens per watt
- Die-cast Aluminum housing with white coat finish
- Prismatic polycarbonate lens
- Super easy wall mounting
- IP65 Waterproof
- (4) 1/2-inch knockouts located on the fixture to offer various options to run surface conduit through. (1) on back, (1) on each side and (1) on top
- Universal 100-277Vac
- DLC Approved

# LED Mini Wall Pack

## Mint Series

SKU #	Model #	Watts	Lumens	CCT	IP	Input Voltage	Certifications
151420	BLT-SWP03-40BA1-W50	40W	5000Lm	5000K	IP65	100-277Vac	UL & DLC
151419	BLT-SWP03-60BA1-W50	60W	7500Lm	5000K	IP65	100-277Vac	UL & DLC

### Dimensions

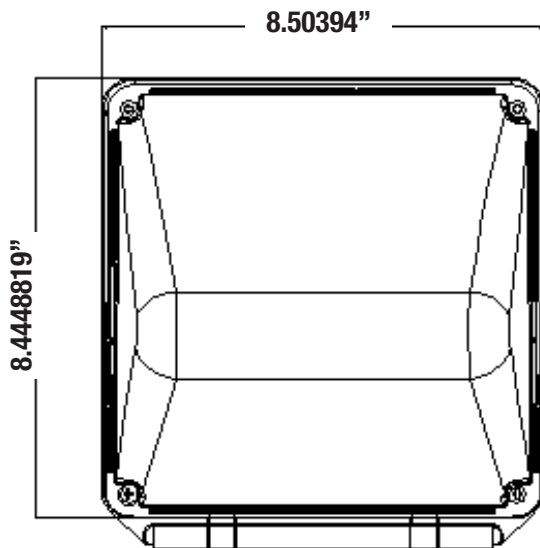
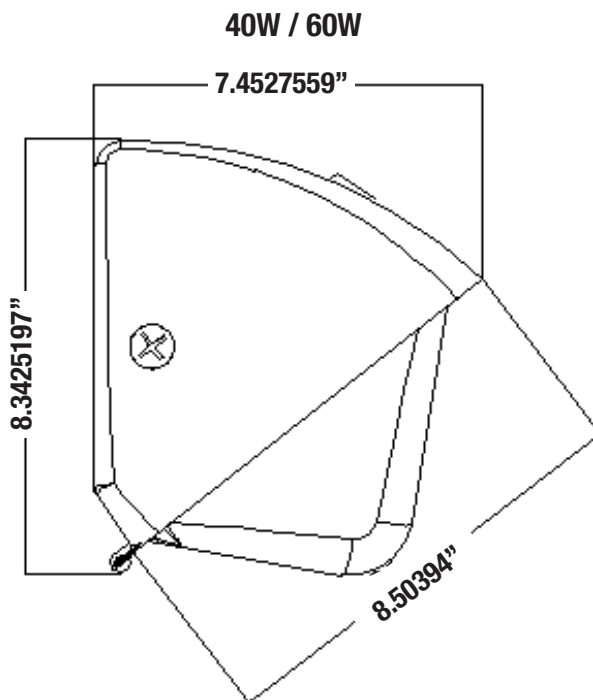

### CORRELATED COLOR TEMPERATURE (CCT)

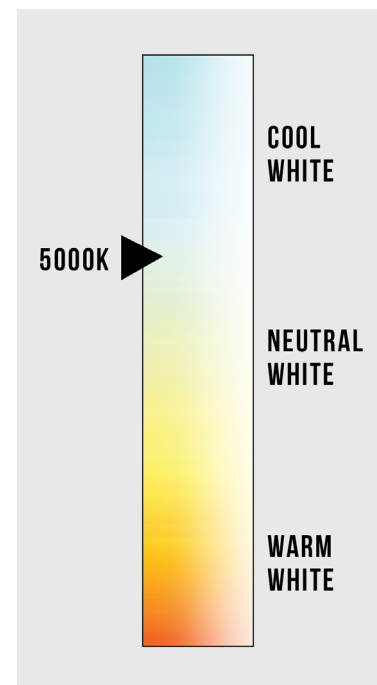

(866) 786-1117 • [www.BeyondLEDTechnology.com](http://www.BeyondLEDTechnology.com)

Due to continuous product improvement, information in this document is subject to change.

# LED Mini Wall Pack

## Mint Series

### 40W Specifications

<b>OPTICAL</b>	Input Power	40W
	Lumen	5000Lm
	Lumen Efficacy	125 Lumens per watt
	Color Temperature	5000K
	CRI	>80
	Viewing Angle	80 Degree
<b>ELECTRICAL</b>	Input Voltage	100-277VAC 50/60Hz
	PF	≥0.9
	THD	≤20%
	Driver Model	Beyond Brand Driver
<b>MATERIALS</b>	LED Type	SMD3030 (1W)
	LED QTY	60 PCS
	Housing	Aluminum(ADC12) +PC
	Housing Color	White
	Cover	Striped Lens
	Waterproof Rating	WET (IP65)
<b>OTHERS</b>	Operating Temperature	-22°F to 113°F
	Operating Humidity	10%-90% RH
	Storage Temperature	-40°F to 176°F
	Storage Humidity	10%-95% RH
	Warranty Time	5 Years



# LED Mini Wall Pack

## Mint Series

### 40W Distribution Diagram

#### Luminaire Property

Luminaire Manufacturer:  
Voltage: 120.5 V  
Power: 42.17 W

Current: 0.355 A  
Power Factor: 0.985

#### Photometric Results

CIE Class: Direct  
Measurement Flux: 5148 lm  
Downward Ratio: 97%  
Horizontal Diffuse Angle(50%): H73.8  
Vertical Diffuse Angle(50%): V86  
Luminaire Efficacy Rating (LER): 122.13  
Max. Intensity: 2737.65 cd  
S/MH(C0/C180): 1.05

Total Rated Lamp Lumens: 5148.0 lm  
Efficiency: 100%  
Upward Ratio: 3%

Central Intensity: 2222.53 cd  
Pos of Max. Intensity: H90 V23  
S/MH(C90/C270): 1.39

Luminous Intensity Distribution Curve

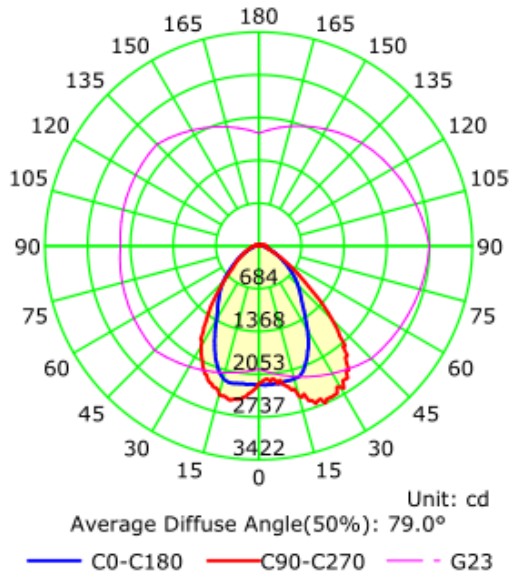

The Average Illuminance Effective Figure

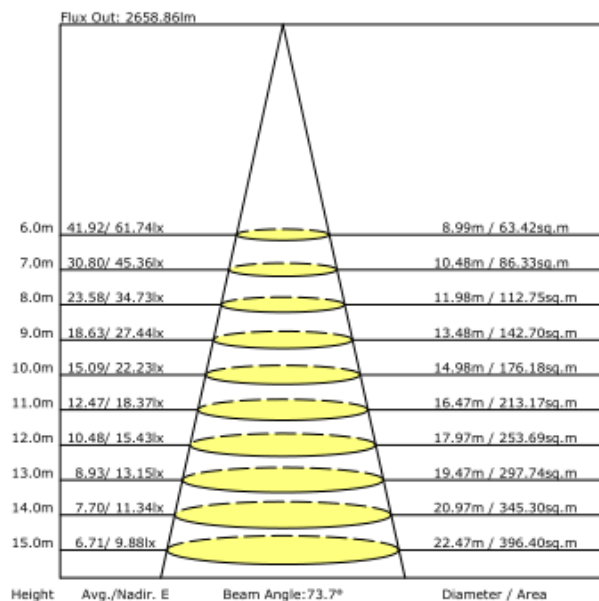

# LED Mini Wall Pack

## Mint Series

### 60W Specifications

<b>OPTICAL</b>	Input Power	60W
	Lumen	7500Lm
	Lumen Efficacy	125 Lumens per watt
	Color Temperature	5000K
	CRI	>80
	Viewing Angle	80 Degree
<b>ELECTRICAL</b>	Input Voltage	100-277VAC 50/60Hz
	PF	≥0.9
	THD	≤20%
	Driver Model	Beyond Brand Driver
<b>MATERIALS</b>	LED Type	SMD3030 (1W)
	LED QTY	90 PCS
	Housing	Aluminum(ADC12) +PC
	Housing Color	White
	Cover	Striped Lens
	Waterproof Rating	WET (IP65)
<b>OTHERS</b>	Operating Temperature	-22°F to 113°F
	Operating Humidity	10%-90% RH
	Storage Temperature	-40°F to 176°F
	Storage Humidity	10%-95% RH
	Warranty Time	5 Years

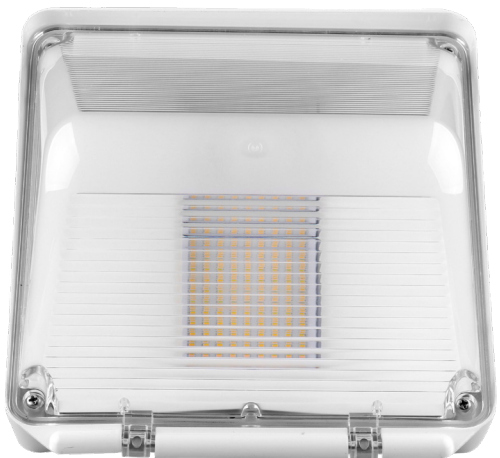

# LED Mini Wall Pack

## Mint Series

### 60W Distribution Diagram

#### Luminaire Property

Luminaire Manufacturer:  
Voltage: 120.4 V  
Power: 62.06 W

Current: 0.523 A  
Power Factor: 0.986

#### Photometric Results

CIE Class: Direct  
Measurement Flux: 7468.3 lm  
Downward Ratio: 97%  
Horizontal Diffuse Angle(50%): H72.7  
Vertical Diffuse Angle(50%): V86.1  
Luminaire Efficacy Rating (LER): 120.39  
Max. Intensity: 3906.33 cd  
S/MH(C0/C180): 1.04

Total Rated Lamp Lumens: 7468.3 lm  
Efficiency: 100%  
Upward Ratio: 3%

Central Intensity: 3296.61 cd  
Pos of Max. Intensity: H90 V26  
S/MH(C90/C270): 1.38

Luminous Intensity Distribution Curve

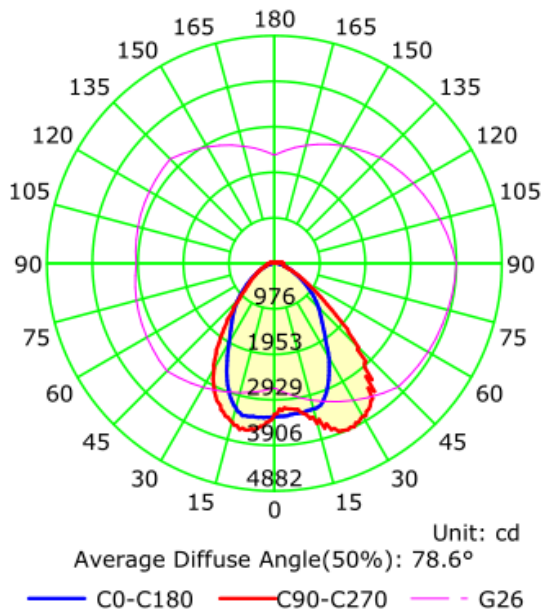

The Average Illuminance Effective Figure

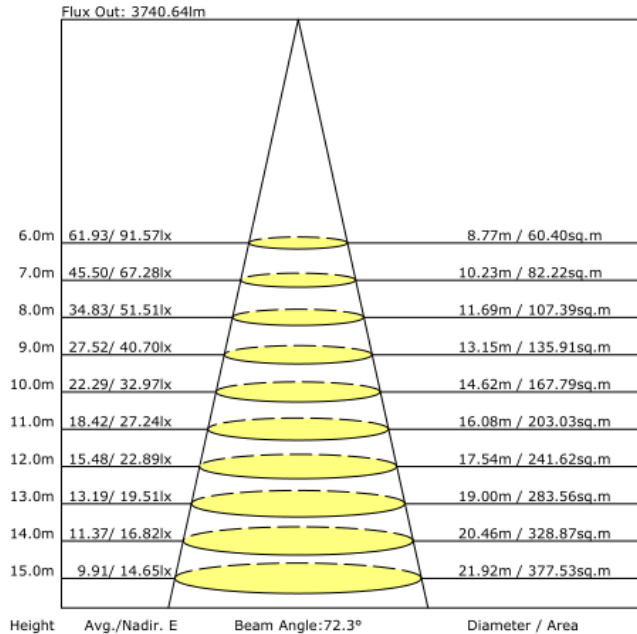

# LED Mini Wall Pack

## Mint Series

### Installation

#### Caution:

1. Please don't use the electric generator to test the LED lamp.
2. Please abide by related country, regional and local law and regulations when install this fixture.
3. Please don't install the fixture when it's raining to lower the risk of electric shock and avoid failure.

#### Note:

1. To avoid possibility of electrical shock or fire, the installation personnel must have professional electric knowledge.
2. Please wear gloves to avoid injury before installation.
3. If any smoke or spark happened, please turn off the power immediately and notify relevant personnel.

#### Installation I:

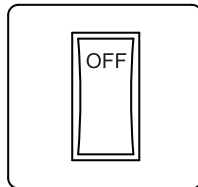

1. Turn off the power.

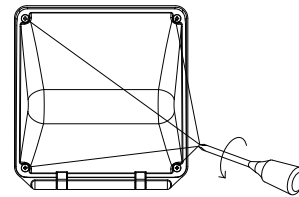

2. Unscrew the 4 screws of the lamp cover and the rubber sleeve on the screw must not be discarded.

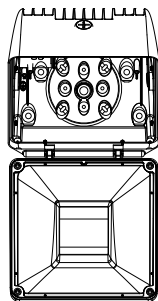

3. Remove the lamp cover, take care not to damage the lamp cover.

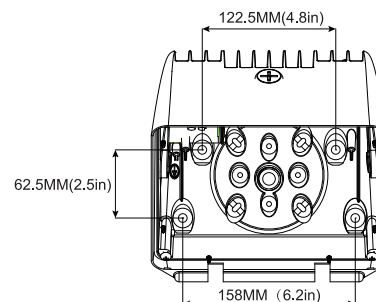

4. Make mounting holes on the wall according to the size shown in the picture. Use an electric drill to drill through the mounting holes on the lamp.

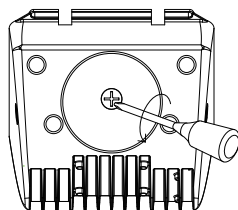

5. Remove the 1/2 plug with a screwdriver.

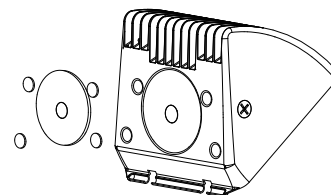

6. Attach the EVA pad to the relevant position on the back of the lamp.

# LED Mini Wall Pack

## Mint Series

### Installation

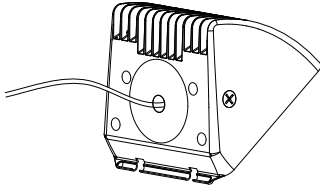

7. Run the power line through the hole.

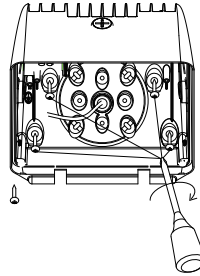

8. Screw the lamp onto the mounting holes.

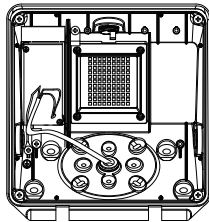

9. Connect the wires correctly and make good protection. Pull out the wire connected to photocell if photocell function is not demanded.

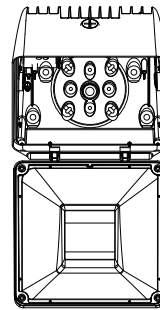

10. Assemble the lamp cover back to the lamp.

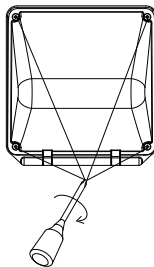

11. Fasten the lamp cover to the lamp body with kit rubber ring.

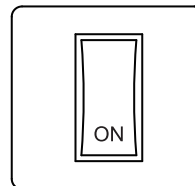

12. Installation is finished and turn the lamp on.

### Installation II:

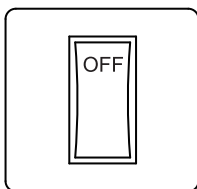

1. Turn off the power.

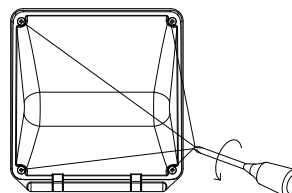

2. Unscrew the 4 screws of the lamp cover and the rubber sleeve on the screw must not be discarded.



# LED Mini Wall Pack

## Mint Series

### Installation

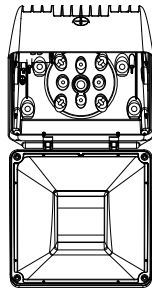

3. Remove the lamp cover, take care not to damage the lamp cover.

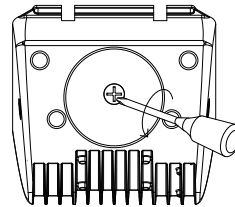

4. Remove the 1/2 plug with a screwdriver.

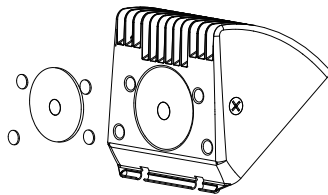

5. Attach the EVA pad to the relevant position on the back of the lamp.

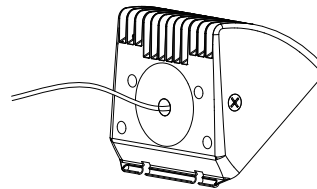

6. Run the power line through the hole.

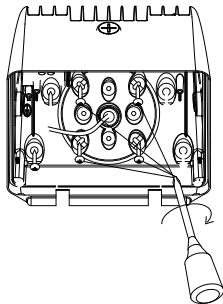

7. Drill through the mounting holes of the mounting plate with an electric drill and screw the lamp onto the mounting plate.

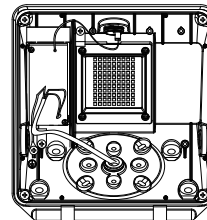

8. Connect the wires correctly and make good protection. Pull out the wire connected to photocell if photocell function is not demanded.

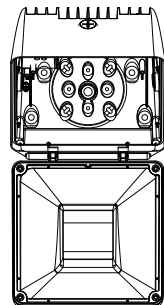

9. Assemble the lamp cover back to the lamp.

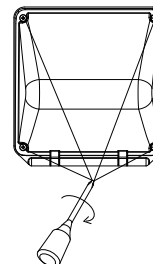

10. Fasten the lamp cover to the lamp body with kit rubber ring.

# LED Mini Wall Pack

## Mint Series

### Installation

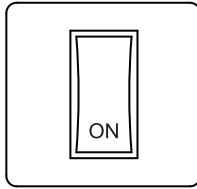

11. Installation is finished and turn the lamp on.

**NOTE:**

THIS PRODUCT MUST BE INSTALLED IN ACCORDANCE WITH THE APPLICABLE INSTALLATION CODE BY A PERSON FAMILIAR WITH THE CONSTRUCTION AND OPERATION OF THE PRODUCT AND THE HAZARDS INVOLVED CONSULT A QUALIFIED ELECTRICIAN TO ENSURE CORRECT BRANCH CIRCUIT CONDUCTOR

CE PRODUIT DOIT ÊTRE INSTALLÉ SELON LE CODE D'INSTALLATION PERTINENT, PAR UNE PERSONNE QUI CONNAÎT BIEN LE PRODUIT ET SON FONCTIONNEMENT AINSI QUE LES RISQUES INHÉRENTS. CONSULTER UN ÉLECTRICIEN QUALIFIÉ POUR VOUS ASSURER QUE LES CONDUCTEURS DE LA DÉRIVATION SONT ADÉQUATS



# LED Mini Wall Pack

## Mint Series

### Packaging

Tolerance of Carton Size:  $\pm 0.590551$  in, Tolerance of Weight:  $\pm 10\%$ .

Model	Pcs/Box	Dimensions	Weight	Pallet Quantity	Pallet Weight	Pallet Dimensions
40W	4	21" X 12" X 21"	17 Lb			
60W	4	21" X 12" X 21"	17 Lb			

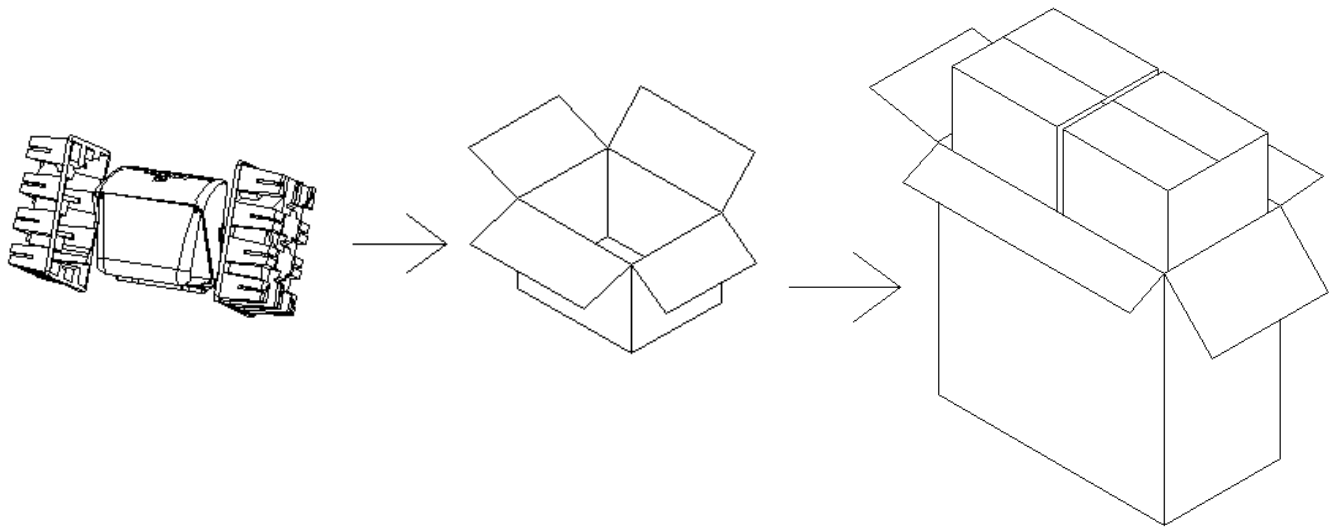

### User Notice

- Please turn off the power before installing or changing assembly parts.
- The input voltage and lamps should be matching. Before connecting the power line, please make sure the wiring section is insulated.
- Only professionals should install and disassemble the lamps.

### Trouble Shooting

- Flickering light - Turn off the power and turn on again in 3 minutes. If the same phenomena occurs, then call Support.
- Not working - Please check all power connections.

# LED Mini Wall Pack

## Mint Series

### Application

