

Data sheet | Item number: 2000-1402

4-conductor through terminal block; 1 mm²; suitable for Ex e II applications; side and center marking; for DIN-rail 35 x 15 and 35 x 7.5; Push-in CAGE CLAMP®; 1,00 mm²; orange

www.wago.com/2000-1402

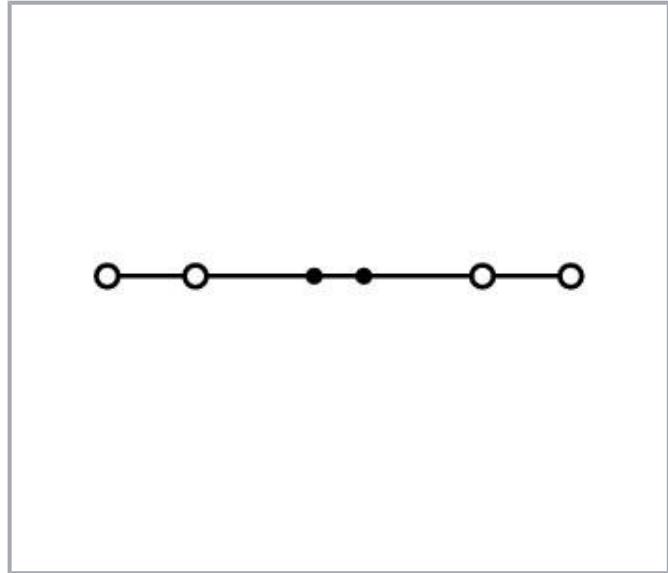
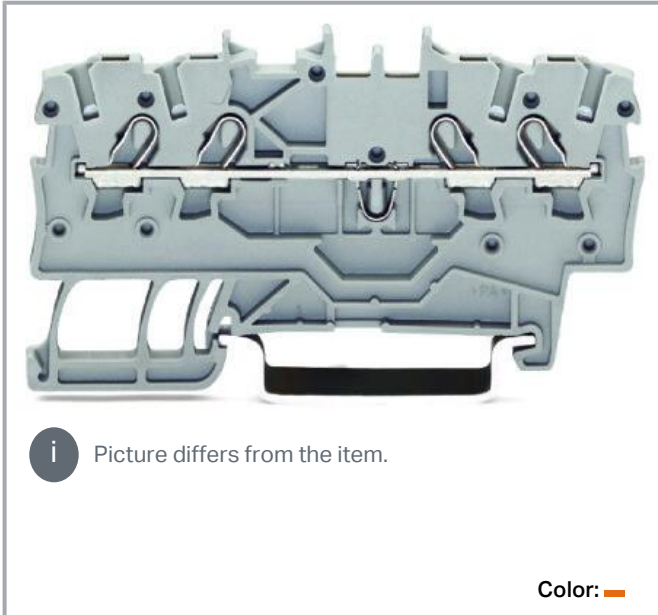

Data

Electrical data

Ratings per IEC/EN

Ratings per	IEC/EN 60947-7-1
Ratings (note)	Electrical data for FR4 PCB type
Nominal voltage (III/3)	800 V
Rated impulse voltage (III/3)	8 kV
Rated current	13.5 A
Current at conductor cross-section (max.) mm ²	17.5 A
Legend (ratings)	(III / 3) ≙ Overvoltage category III / Pollution degree 3

Ratings per UL 1059

Approvals per	UL 1059
Rated voltage UL (Use Group B)	600 V
Rated current UL (Use Group B)	15 A

Subject to changes. Please also observe the further product documentation!

WAGO GmbH & Co. KG
Hansastr. 27
32423 Minden
Phone: +49571 887-0 | Fax: +49571 887-169
Email: info.de@wago.com | Web: www.wago.com

Do you have any questions about our products?
We are always happy to take your call at +49 (571) 887-44222.



Rated voltage UL (Use Group C)	600 V
Rated current UL (Use Group C)	15 A

Ratings per CSA

Approvals per	CSA 22.2 No 158
Rated voltage CSA (Use Group B)	600 V
Rated current CSA (Use Group B)	10 A
Rated voltage CSA (Use Group C)	600 V
Rated current CSA (Use Group C)	10 A

Ex information

Reference hazardous areas	See application instructions in section "Knowledge and Downloads – Documentation – Additional Information: Technical Section; Technical Explications"
Ratings per	ATEX: PTB 11 ATEX 1041 U / IECEx: PTB 11.0093U (Ex eb IIC Gb)
Rated voltage EN (Ex e II)	550 V
Rated current (Ex e II)	13 A
Rated current (Ex e II) with jumper	12 A

Power loss

Power loss, per pole (potential)	0.434 W
Rated current I_N for specified power loss	13.5 A
Resistance value for specified, current-dependent power loss	0.002 Ω

Connection data

Connection points	4
Total number of potentials	1
Number of levels	1
Number of jumper slots	2

Connection 1

Connection technology	Push-in CAGE CLAMP®
Actuation type	Operating tool
Connectable conductor materials	Copper
Nominal cross-section	1 mm ²
Solid conductor	0.14 ... 1.5 mm ² / 24 ... 16 AWG

Subject to changes. Please also observe the further product documentation!



Solid conductor; push-in termination	0.5 ... 1.5 mm ² / 20 ... 16 AWG
Fine-stranded conductor	0.14 ... 1.5 mm ² / 24 ... 16 AWG
Fine-stranded conductor; with insulated ferrule	0.14 ... 0.75 mm ² / 24 ... 18 AWG
Fine-stranded conductor; with ferrule; push-in termination	0.5 ... 0.75 mm ² / 20 ... 18 AWG
Note (conductor cross-section)	Depending on the conductor characteristic, a conductor with a smaller cross-section can also be inserted via push-in termination.
Strip length	9 ... 11 mm / 0.35 ... 0.43 inches
Wiring direction	Front-entry wiring

Physical data

Width	3.5 mm / 0.138 inches
Height	67.9 mm / 2.673 inches
Depth from upper-edge of DIN-rail	32.9 mm / 1.295 inches

Mechanical Data

Mounting type	DIN-35 rail
Marking level	Center/side marking

Material Data

Note (material data)	Information on material specifications can be found here
Color	orange
Material group	I
Insulation material	Polyamide (PA66)
Flammability class per UL94	V0
Fire load	0.107 MJ
Weight	5.1 g

Environmental requirements

Processing temperature	-35 ... +85 °C
Continuous operating temperature	-60 ... +105 °C

Commercial data

Product Group	22 (TOPJOB S)
eCl@ss 10.0	27-14-11-20
eCl@ss 9.0	27-14-11-20

Subject to changes. Please also observe the further product documentation!





ETIM 8.0	EC000897
ETIM 7.0	EC000897
PU (SPU)	100 pcs
Packaging type	box
Country of origin	CN
GTIN	4045454966935
Customs tariff number	85369010000

Environmental Product Compliance

RoHS Compliance Status	Compliant, No Exemption
------------------------	-------------------------

Approvals / Certificates

General approvals

Logo	Approval	Additional Approval Text	Certificate name
	CCA DEKRA Certification B.V.	EN 60947	NTR NL 7962
	CCC CNEX	GB/T 3836.3	2020312313000182 (Ex eb IIC Gb, Ex eb I Mb)
	CSA DEKRA Certification B.V.	C22.2	2130762
	KEMA/KEUR DEKRA Certification B.V.	EN 60947	71-125928
	UL Underwriters Laboratories Inc.	UL 1059	E45172

Declarations of conformity and manufacturer's declarations

Logo	Approval	Additional Approval Text	Certificate name
	EU-Declaration of Conformity WAGO GmbH & Co. KG	-	-

Subject to changes. Please also observe the further product documentation!



Railway
WAGO GmbH & Co. KG

-

Railway
Ready







UK-Declaration of Conformity
WAGO GmbH & Co. KG



-

-

Approvals for marine applications

Logo	Approval	Additional Approval Text	Certificate name
	ABS American Bureau of Shipping	EN 60947	20- HG1941090- PDA
	BV Bureau Veritas S.A.	EN 60947	38586/B0 BV
	DNV GL Det Norske Veritas, Germanischer Lloyd	-	TAE00001V2
	LR Lloyds Register	EN 60947	91/20112 (E10)



Approvals for hazardous areas

Logo	Approval	Additional Approval Text	Certificate name
	AEx Underwriters Laboratories Inc.	UL 60079	E185892 (AEx eb IIC resp. Ex eb IIC)
	ATEX Physikalisch Technische Bundesanstalt	EN 60079	PTB 11 ATEX 1041 U (II 2 G Ex eb IIC Gb bzw. I M 2 Ex eb I Mb)
	CCC CNEX	GB/T 3836.3	2020312313000182 (Ex eb IIC Gb, Ex eb I Mb)

Subject to changes. Please also observe the further product documentation!

WAGO GmbH & Co. KG
Hansastr. 27
32423 Minden
Phone: +49571 887-0 | Fax: +49571 887-169
Email: info.de@wago.com | Web: www.wago.com

Do you have any questions about our products?
We are always happy to take your call at +49 (571) 887-44222.

	EAC Brjansker Zertifizierungsstelle	TP TC 012/2011	RU C-DE.AM02.B. 00127/19 (Ex e IIC Gb U)
	IECEX Physikalisch Technische Bundesanstalt	IEC 60079	IECEx PTB 11.0093U (Ex e IIC Gb or Ex e I Mb)

Required accessories

End plate



End plate

	Item no.: 2000-1492 End and intermediate plate; 0.7 mm thick; orange	www.wago.com/2000-1492
	Item no.: 2000-1491 End and intermediate plate; 0.7 mm thick; gray	www.wago.com/2000-1491

Optional accessories

Ferrule

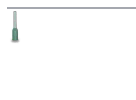
Ferrule

	Item no.: 216-241 Ferrule; Sleeve for 0.5 mm ² / 20 AWG; insulated; electro-tin plated; electrolytic copper; gastight crimped; acc. to DIN 46228, Part 4/09.90; white	www.wago.com/216-241
	Item no.: 216-242 Ferrule; Sleeve for 0.75 mm ² / 18 AWG; insulated; electro-tin plated; electrolytic copper; gastight crimped; acc. to DIN 46228, Part 4/09.90; gray	www.wago.com/216-242
	Item no.: 216-243 Ferrule; Sleeve for 1 mm ² / AWG 18; insulated; electro-tin plated; electrolytic copper; gastight crimped; acc. to DIN 46228, Part 4/09.90; red	www.wago.com/216-243



Protective warning marker

Cover

	Item no.: 2000-115 Protective warning marker; for 5 terminal blocks; with high-voltage symbol, black; yellow	www.wago.com/2000-115
--	--	--

Jumpers

Jumper

	Item no.: 210-123 Wire commoning chain; insulated; blue	www.wago.com/210-123
	Item no.: 2000-408 Jumper; 8-way; insulated; light gray	www.wago.com/2000-408
	Item no.: 2000-407	

Subject to changes. Please also observe the further product documentation!

Jumper; 7-way; insulated; light gray

www.wago.com/2000-407



Item no.: 2000-409

Jumper; 9-way; insulated; light gray

www.wago.com/2000-409



Item no.: 2000-408/000-006

Jumper; 8-way; insulated; blue

www.wago.com/2000-408/000-006



Item no.: 2000-408/000-005

Jumper; 8-way; insulated; red

www.wago.com/2000-408/000-005



Item no.: 2000-409/000-005

Jumper; 9-way; insulated; red

www.wago.com/2000-409/000-005



Item no.: 2000-407/000-006

Jumper; 7-way; insulated; blue

www.wago.com/2000-407/000-006



Item no.: 2000-410

Jumper; 10-way; insulated; light gray

www.wago.com/2000-410



Item no.: 2000-410/000-006

Jumper; 10-way; insulated; blue

www.wago.com/2000-410/000-006



Item no.: 2000-433/000-005

Jumper; from 1 to 3; insulated; red

www.wago.com/2000-433/000-005



Item no.: 2000-407/000-005

Jumper; 7-way; insulated; red

www.wago.com/2000-407/000-005



Item no.: 2000-433/000-006

Jumper; from 1 to 3; insulated; blue

www.wago.com/2000-433/000-006



Item no.: 2000-410/000-005

Jumper; 10-way; insulated; red

www.wago.com/2000-410/000-005



Item no.: 2000-435

Jumper; from 1 to 5; insulated; light gray

www.wago.com/2000-435

Subject to changes. Please also observe the further product documentation!

WAGO GmbH & Co. KG

Hansastr. 27

32423 Minden

Phone: +49571 887-0 | Fax: +49571 887-169

Email: info.de@wago.com | Web: www.wago.com















Do you have any questions about our products?

We are always happy to take your call at +49 (571) 887-44222.















Item no.: 2000-409/000-006
Jumper; 9-way; insulated; blue

www.wago.com/2000-409/000-006

	Item no.: 2000-436 Jumper; from 1 to 6; insulated; light gray	www.wago.com/2000-436
	Item no.: 2000-433 Jumper; from 1 to 3; insulated; light gray	www.wago.com/2000-433
	Item no.: 2000-434 Jumper; from 1 to 4; insulated; light gray	www.wago.com/2000-434
	Item no.: 2000-402 Jumper; 2-way; insulated; light gray	www.wago.com/2000-402
	Item no.: 2000-402/000-006 Jumper; 2-way; insulated; blue	www.wago.com/2000-402/000-006
	Item no.: 2000-403 Jumper; 3-way; insulated; light gray	www.wago.com/2000-403
	Item no.: 2000-402/000-005 Jumper; 2-way; insulated; red	www.wago.com/2000-402/000-005
	Item no.: 2000-402/000-018 Jumper; 2-way; insulated; yellow-green	www.wago.com/2000-402/000-018
	Item no.: 2000-404 Jumper; 4-way; insulated; light gray	www.wago.com/2000-404
	Item no.: 2000-403/000-005 Jumper; 3-way; insulated; red	www.wago.com/2000-403/000-005
	Item no.: 2000-404/000-006 Jumper; 4-way; insulated; blue	www.wago.com/2000-404/000-006
	Item no.: 2000-403/000-006 Jumper; 3-way; insulated; blue	www.wago.com/2000-403/000-006
	Item no.: 2000-404/000-005 Jumper; 4-way; insulated; red	www.wago.com/2000-404/000-005
	Item no.: 2000-405 Jumper; 5-way; insulated; light gray	www.wago.com/2000-405

Subject to changes. Please also observe the further product documentation!

	Item no.: 2000-405/011-000 Star point jumper; 3-way; insulated; light gray	www.wago.com/2000-405/011-000
	Item no.: 2000-405/000-006 Jumper; 5-way; insulated; blue	www.wago.com/2000-405/000-006
	Item no.: 2000-406/000-006 Jumper; 6-way; insulated; blue	www.wago.com/2000-406/000-006
	Item no.: 2000-405/000-005 Jumper; 5-way; insulated; red	www.wago.com/2000-405/000-005
	Item no.: 2000-406 Jumper; 6-way; insulated; light gray	www.wago.com/2000-406
	Item no.: 2000-406/000-005 Jumper; 6-way; insulated; red	www.wago.com/2000-406/000-005
	Item no.: 2000-406/020-000 Delta jumper; insulated; light gray	www.wago.com/2000-406/020-000
	Item no.: 2000-437 Jumper; from 1 to 7; insulated; light gray	www.wago.com/2000-437
	Item no.: 2000-438 Jumper; from 1 to 8; insulated; light gray	www.wago.com/2000-438
	Item no.: 2000-439 Jumper; from 1 to 9; insulated; light gray	www.wago.com/2000-439
	Item no.: 2000-440 Jumper; from 1 to 10; insulated; light gray	www.wago.com/2000-440
	Item no.: 210-103 Wire commoning chain; insulated; black	www.wago.com/210-103
Mounting		
Cover carrier		
	Item no.: 709-169 Cover carrier; Type 3; gray	www.wago.com/709-169
Cover		

Subject to changes. Please also observe the further product documentation!



Item no.: 709-156
Cover; Type 3; suitable for cover carrier, type 3; 1 m long; transparent

www.wago.com/709-156

Tool

Operating tool



Item no.: 210-648
Operating tool; Blade: 2.5 x 0.4 mm; with a partially insulated shaft; angled; short

www.wago.com/210-648



Item no.: 210-647
Operating tool; Blade: 2.5 x 0.4 mm; with a partially insulated shaft; multicoloured

www.wago.com/210-647



Item no.: 210-719
Operating tool; Blade: 2.5 x 0.4 mm; with a partially insulated shaft

www.wago.com/210-719

Carrier rail

Mounting accessories



Item no.: 210-197
Steel carrier rail; 35 x 15 mm; 1.5 mm thick; 2 m long; slotted; similar to EN 60715; silver-colored

www.wago.com/210-197



Item no.: 210-198
Copper carrier rail; 35 x 15 mm; 2.3 mm thick; 2 m long; unslotted; according to EN 60715; copper-colored

www.wago.com/210-198



Item no.: 210-113
Steel carrier rail; 35 x 7.5 mm; 1 mm thick; 2 m long; unslotted; according to EN 60715; silver-colored

www.wago.com/210-113

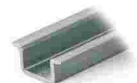

Item no.: 210-118
Steel carrier rail; 35 x 15 mm; 2.3 mm thick; 2 m long; unslotted; according to EN 60715; silver-colored

www.wago.com/210-118



Item no.: 210-112
Steel carrier rail; 35 x 7.5 mm; 1 mm thick; 2 m long; slotted; according to EN 60715; "Hole width 25 mm; silver-colored

www.wago.com/210-112



Item no.: 210-114
Steel carrier rail; 35 x 15 mm; 1.5 mm thick; 2 m long; unslotted; similar to EN 60715; silver-colored

www.wago.com/210-114



Item no.: 210-115
Steel carrier rail; 35 x 7.5 mm; 1 mm thick; 2 m long; slotted; according to EN 60715; "Hole width 18 mm; silver-colored

www.wago.com/210-115

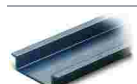

Item no.: 210-196
Aluminum carrier rail; 35 x 8.2 mm; 1.6 mm thick; 2 m long; unslotted; similar to EN 60715; silver-colored

www.wago.com/210-196

Marking accessories

Marking strip













Item no.: 2009-110
Marking strips; for Smart Printer; on reel; not stretchable; plain; snap-on type; white

www.wago.com/2009-110

Subject to changes. Please also observe the further product documentation!

Marker

	Item no.: 2009-113 WMB-Inline; for Smart Printer; 2300 pieces on roll; plain; snap-on type; white	www.wago.com/2009-113
	Item no.: 2009-113/000-002 WMB-Inline; for Smart Printer; 2300 pieces on roll; plain; snap-on type; yellow	www.wago.com/2009-113/000-002
	Item no.: 2009-113/000-012 WMB-Inline; for Smart Printer; 2300 pieces on roll; plain; snap-on type; orange	www.wago.com/2009-113/000-012
	Item no.: 2009-113/000-007 WMB-Inline; for Smart Printer; 2300 pieces on roll; plain; snap-on type; gray	www.wago.com/2009-113/000-007
	Item no.: 2009-113/000-005 WMB-Inline; for Smart Printer; 2300 pieces on roll; plain; snap-on type; red	www.wago.com/2009-113/000-005
	Item no.: 2009-113/000-017 WMB-Inline; for Smart Printer; 2300 pieces on roll; plain; snap-on type; light green	www.wago.com/2009-113/000-017
	Item no.: 2009-113/000-006 WMB-Inline; for Smart Printer; 2300 pieces on roll; plain; snap-on type; blue	www.wago.com/2009-113/000-006
	Item no.: 2009-113/000-024 WMB-Inline; for Smart Printer; 2300 pieces on roll; plain; snap-on type; violet	www.wago.com/2009-113/000-024
	Item no.: 2009-113/000-023 WMB-Inline; for Smart Printer; 2300 pieces on roll; plain; snap-on type; green	www.wago.com/2009-113/000-023
	Item no.: 793-3501 WMB marking card; as card; plain; snap-on type; white	www.wago.com/793-3501

Group marker carrier

	Item no.: 2009-191 Group marker carrier; gray	www.wago.com/2009-191
--	---	--

Testing and measuring

Testing accessories

	Item no.: 2009-174 Test plug adapter; for 4 mm Ø test plugs; for testing TOPJOB®S rail-mounted terminal blocks; gray	www.wago.com/2009-174
--	--	--

Subject to changes. Please also observe the further product documentation!



Item no.: 2009-182

Testing tap; for max. 2.5 mm²; tool-free connection for individual test wires 0.08 - 2.5 mm; gray

www.wago.com/2009-182



Item no.: 2000-510

TOPJOB®S L-type test plug module; modular; for jumper contact slot; 1,00 mm²; gray

www.wago.com/2000-510



Item no.: 2000-511

TOPJOB®S L-type test plug module; modular; for jumper contact slot; 1-pole; 1,00 mm²; gray

www.wago.com/2000-511



Item no.: 2000-549

Spacer module; modular; e.g., for bridging commoned terminal blocks; gray

www.wago.com/2000-549



Item no.: 2000-555

Modular TOPJOB®S connector; modular; for jumper contact slot; 5-pole; 1,00 mm²; gray

www.wago.com/2000-555



Item no.: 2000-553

Modular TOPJOB®S connector; modular; for jumper contact slot; 3-pole; 1,00 mm²; gray

www.wago.com/2000-553



Item no.: 2000-556

Modular TOPJOB®S connector; modular; for jumper contact slot; 6-pole; 1,00 mm²; gray

www.wago.com/2000-556



Item no.: 2000-558

Modular TOPJOB®S connector; modular; for jumper contact slot; 8-pole; 1,00 mm²; gray

www.wago.com/2000-558



Item no.: 2000-559

Modular TOPJOB®S connector; modular; for jumper contact slot; 9-pole; 1,00 mm²; gray

www.wago.com/2000-559



Item no.: 2000-552

Modular TOPJOB®S connector; modular; for jumper contact slot; 2-pole; 1,00 mm²; gray

www.wago.com/2000-552



Item no.: 2000-560

Modular TOPJOB®S connector; modular; for jumper contact slot; 10-pole; 1,00 mm²; gray

www.wago.com/2000-560



Item no.: 2000-554

Modular TOPJOB®S connector; modular; for jumper contact slot; 4-pole; 1,00 mm²; gray

www.wago.com/2000-554



Item no.: 2000-557

Modular TOPJOB®S connector; modular; for jumper contact slot; 7-pole; 1,00 mm²; gray

www.wago.com/2000-557



Item no.: 210-136

Test plug; 2 mm Ø; with 500 mm cable; red

www.wago.com/210-136

Push-in type wire jumper

Jumper



Item no.: 2009-404

Push-in type wire jumper; 0.75 mm²; insulated; 110 mm long; gray

www.wago.com/2009-404



Item no.: 2009-402

Push-in type wire jumper; 0.75 mm²; insulated; 60 mm long; gray

www.wago.com/2009-402

Subject to changes. Please also observe the further product documentation!

WAGO GmbH & Co. KG

Hansastr. 27

32423 Minden

Phone: +49571 887-0 | Fax: +49571 887-169

Email: info.de@wago.com | Web: www.wago.com

Do you have any questions about our products?

We are always happy to take your call at +49 (571) 887-44222.



Item no.: 2009-406

Push-in type wire jumper; 0.75 mm²; insulated; 250 mm long; gray

www.wago.com/2009-406

Downloads

Documentation

Bid Text

2000-1402 X81 - Datei	2019 Feb 19	xml 4.0 kB	Download
--------------------------	-------------	---------------	----------

2000-1402 docx - Datei	2018 Aug 7	docx 14.9 kB	Download
---------------------------	------------	-----------------	----------

Additional Information

Technical Section Technical explanations		pdf 2.2 MB	Download
---	--	---------------	----------

CAD/CAE-Data

CAE data

EPLAN Data Portal 2000-1402		URL	Download
-----------------------------	--	-----	----------

WSCAD Universe 2000-1402		URL	Download
--------------------------	--	-----	----------

ZUKEN Portal 2000-1402		URL	Download
------------------------	--	-----	----------

CAD data

2D/3D Models 2000-1402		URL	Download
------------------------	--	-----	----------

Environmental Product Compliance

Compliance Search

Environmental Product Compliance 2000-1402		URL	Download
--	--	-----	----------

4-conductor through terminal block; 1 mm²; suitable for Ex e II applications; side and center marking; for DIN-rail 35 x 15 and 35 x 7.5; Push-in CAGE CLAMP®; 1,00 mm²; orange

Subject to changes. Please also observe the further product documentation!

Installation Notes

Conductor termination

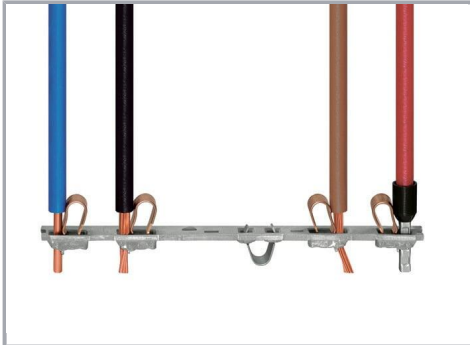

All conductor types at a glance

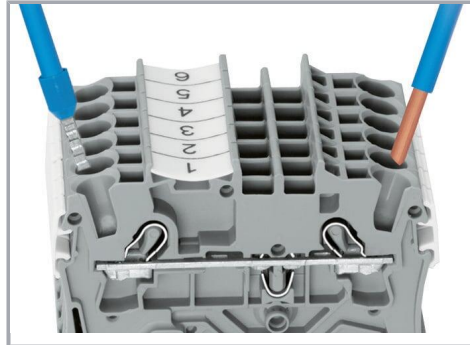

Push-in termination of solid and ferruled conductors

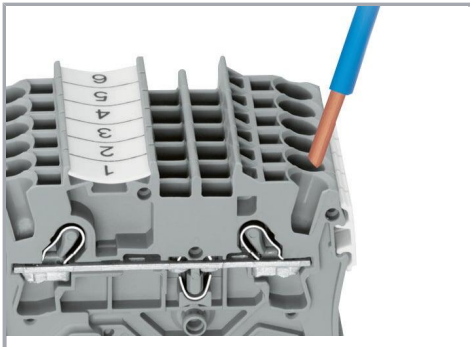

Inserting a conductor via push-in termination:

Solid conductors with cross-sections from either one size above, or up to two sizes below, the rated cross-section can be simply pushed in – no tools needed.

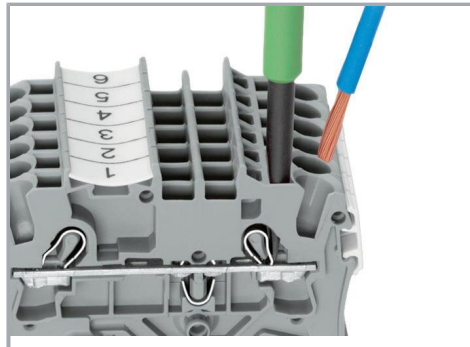

Inserting a conductor via operating tool:

Connecting fine-stranded conductors without ferrules, or small cross-sectional conductors that cannot be pushed in, is performed similarly to the original CAGE CLAMP® – just use an operating tool.

Advantage:

To open the clamp, the operating tool is inserted vertically. The conductor entry is less than 15 degrees for easier wiring.

Commoning

Subject to changes. Please also observe the further product documentation!



Insert push-in type jumper bar and push down until it hits backstop.

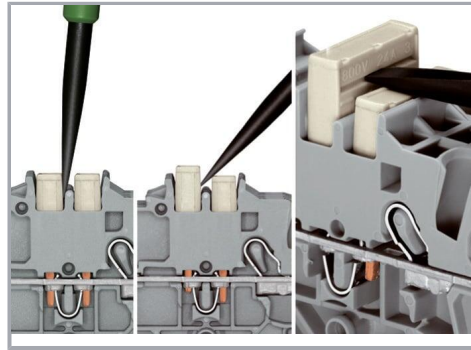

Removing a push-in type jumper bar:

Insert the operating tool between the jumper and partition wall of the dual jumper slots, then lift up the jumper.

Place the operating tool in the center of jumpers for up to five contacts (see above), or alternately on both sides for jumpers with more than five contacts.

Commoning

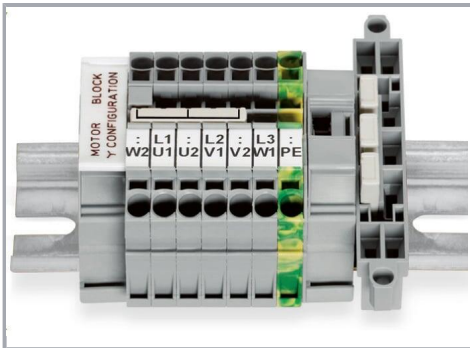

This star point jumper has been specially developed to create a "star point" and is used on motor terminal boards equipped with Rail-Mount Terminal Blocks TOPJOB® S.

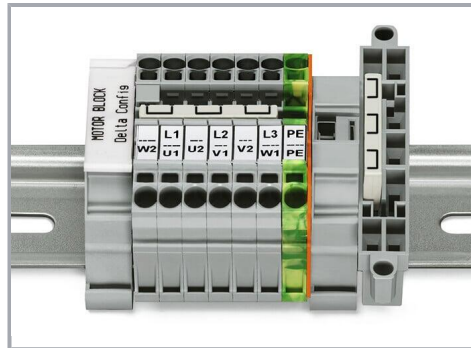

This delta jumper has been specially developed to create a delta configuration and is used on motor terminal boards equipped with rail-mount terminal blocks TOPJOB® S.

Subject to changes. Please also observe the further product documentation!

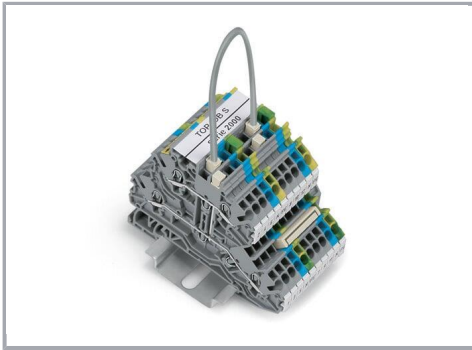

Push down the wire jumper (2009-402) until fully inserted. For rewiring, lift the jumper with an operating tool at the notch provided for this purpose on the jumper.

Testing

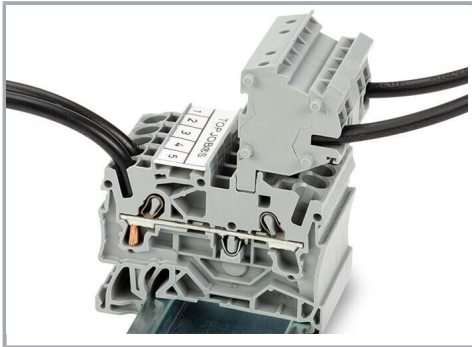

The modular TOPJOB® S connectors also connect conductors of the same size as the terminal blocks being used.

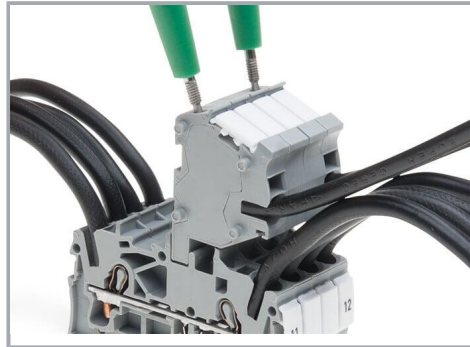

TOPJOB® S Connectors with a 2 mm Ø test socket for testing voltage via 2-pole voltage tester

Subject to changes. Please also observe the further product documentation!

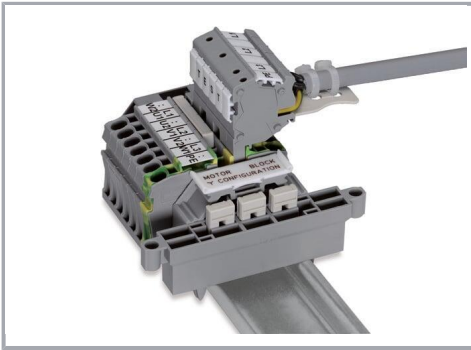

Rail-mount terminal block assembly for electric motor wiring



Test plug adapter (2009-174, CAT I) for 4 mm Ø plugs – compatible with 2000 to 2016 Series

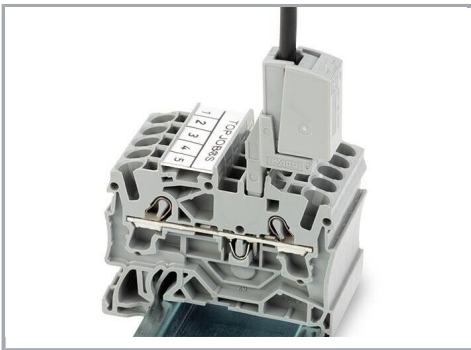

Testing tap (2009-182) for tool-free connection of test cables up to 2.5 mm² (12 AWG) – compatible with 2000 to 2016 Series

Marking

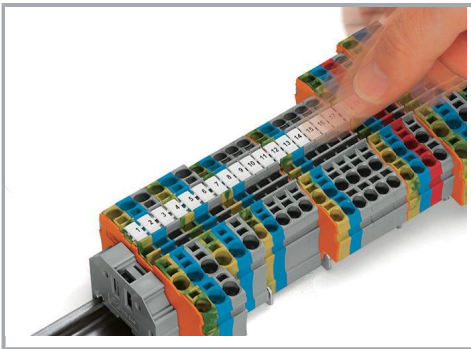

Snapping WMB Inline markers into marker slots.

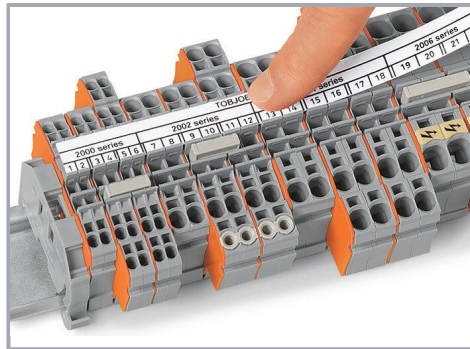

Subject to changes. Please also observe the further product documentation!

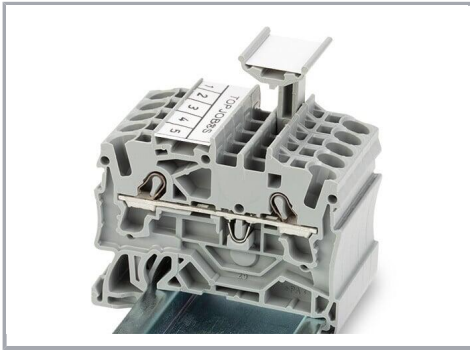

TOPJOB® S 2009-193 Group Marker Carrier (equipped with a marking strip) for all 2001 to 2016 Series TOPJOB® S Rail-Mount Terminal Blocks

Do not use on an end plate!

Ex application

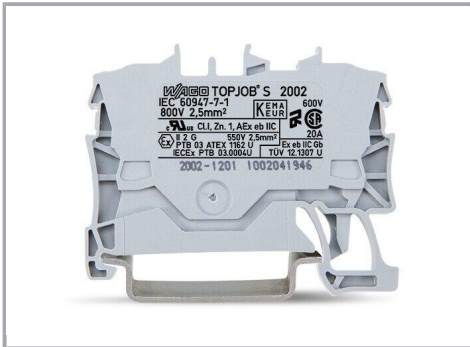

Through terminal blocks with a blue insulated housing are suitable for Ex i applications.

Subject to changes. Please also observe the further product documentation!

WAGO GmbH & Co. KG
Hansastr. 27
32423 Minden
Phone: +49571 887-0 | Fax: +49571 887-169
Email: info.de@wago.com | Web: www.wago.com

Do you have any questions about our products?
We are always happy to take your call at +49 (571) 887-44222.



All through and ground conductor terminal blocks are suitable for Ex e II applications.

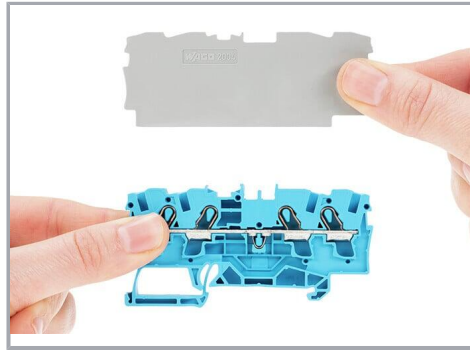

Separator plate for Ex e/Ex i applications

An end plate must be applied to the terminal block located directly behind an Ex e/Ex i separator plate.



Ex e II/Ex i terminal strip

Note:

The movable feet of terminal blocks and separator plates must face the same direction.



A separator plate is located between the Ex e II and Ex i terminal strip.

End plate

Ex e II terminal blocks

Separator plate for Ex e/Ex i applications

End plate

Ex i terminal blocks

According to EN 50020, a minimum distance of 50 mm must be kept between live parts of Ex e and Ex i circuits. The use of Ex e/Ex i separators is a space-saving solution when Ex e and Ex i terminal blocks are mounted on a common DIN-rail.

Product family

Subject to changes. Please also observe the further product documentation!



TOPJOB® S

TOPJOB® S: In various industrial applications and modern building installations, WAGO's wide and versatile range of rail-mount terminal blocks provides more than just reliable electrical connections.

[Show all products from the family](#)

Subject to changes. Please also observe the further product documentation!

WAGO GmbH & Co. KG
Hansastr. 27
32423 Minden
Phone: +49571 887-0 | Fax: +49571 887-169
Email: info.de@wago.com | Web: www.wago.com

Do you have any questions about our products?
We are always happy to take your call at +49 (571) 887-44222.