



**IDEALPOWER**

experts in power conversion

# SPECIFICATION FOR APPROVAL

CUSTOMER: \_\_\_\_\_

DESCRIPTION: SWITCHING POWER SUPPLY REV: (A2)

MODEL NO: HK-AY-240A100-CP PART NO: HKSC-170003

DESIGNED NO: 170003-0103 DATE: MAR.06th.2020

CUSTOMER APPROVED SIGNATURES			VENDOR APPROVED SIGNATURES		
					

Ideal Power, 14 Larks Way, Tree Beech Enterprise Park, Gunn, Barnstaple, Devon, England EX32 7NZ

Web: [www.idealpower.co.uk](http://www.idealpower.co.uk) email: [sales@idealpower.co.uk](mailto:sales@idealpower.co.uk) TEL +44 (0) 845 2603400 Fax +44 (0) 845 2603401





MODEL NO. :	HK-AY-240A100-CP	PAGE NO. :	1 OF 15
PART NO. :	HKSC-170003	ISSUED DATE:	2020.03.06
DESCRIPTION :	SWITCHING POWER SUPPLY	REV:	(A2)

## CONTENTS

1. INTRODUCTION
2. INPUT REQUIREMENTS
3. OUTPUT REQUIREMENTS
4. EFFICIENCY
5. LINE REGULATION
6. HOLD UP TIME
7. TURN ON TIME
8. TEMPERATURE COEFFICIENT
9. DIELECTRIC STRENGTH (Hi-Pot) TEST
10. INSULATION RESISTANCE
11. PROTECTION
12. ENVIRONMENTAL CONDITIONS
13. EMI/ EMC
14. RELIABILITY AND QUALITY CONTROL
15. SAFETY
16. OVERALL DRAWING
17. USE SPECIFICATION
18. PACKING
19. MARKING



MODEL NO. :	HK-AY-240A100-CP	PAGE NO. :	2 OF 15
PART NO. :	HKSC-170003	ISSUED DATE:	2020.03.06
DESCRIPTION :	SWITCHING POWER SUPPLY	REV:	(A2)

## 1.0 INTRODUCTION

This document specifies a switching power supply with a output of +24V, and electronic process. The switching power supply will provide power for technology equipments including electrical business equipment. The adaptor meets the requirement of lead free and RoHS.

## 2.0 INPUT REQUIREMENTS

2.1 Input Voltage Range: 100(-10%)VAC to 240(+10%)VAC

2.2 Input Frequency Range: 47 Hz to 63 Hz

2.3 Input Power Consumption at no-load : 0.1W Max

Test condition will be tested after No load operating for 30min then measure it.

2.4 Input In-rush Current: 60A Max

2.5 Input Current: 0.8A Max

## 3.0 OUTPUT REQUIREMENTS

3.1 Output Voltage: +24V

3.2 Output Regulation: 22.8-25.2V

3.3 Output Load Range: 0-1.0A

3.4 Output Ripple & Noise: 200mV Max @20MHz bandwidth with  
10UF/50V capacitance and 104/50V ceramic capacitor.

4.0 EFFICIENCY:  $\geq 86.2\%$  @average of 25/50/75/100% loads 115&230VAC input

Test condition will be tested after full load operating for 30min then measure it.

5.0 LINE REGULATION:  $\pm 2\%$  maximum

6.0 HOLD UP TIME: 10ms Min at 110VAC full load.

7.0 TURN ON TIME: 2S Max at 110VAC full load.



MODEL NO. :	HK-AY-240A100-CP	PAGE NO. :	3 OF 15
PART NO. :	HKSC-170003	ISSUED DATE:	2020.03.06
DESCRIPTION :	SWITCHING POWER SUPPLY	REV:	(A2)

8.0 TEMPERATURE COEFFICIENT: 0.05%/°C

9.0 DIELECTRIC STRENGTH (Hi-Pot) TEST

9.1 Primary to Secondary :AC 3000 Vrms ,4mA,1minute for type test,  
2 second for production test.

10.0 INSULATION RESISTANCE

Primary to secondary: 50M OHM to 500VDC.

11.0 PROTECTION

11.1 Input Protection

The switching power supply has a 2 Amps inner current fuse to protect itself.

11.2 Output Protection

11.2.1 Output Current:

Overload conditions shall decrease the output current. Removal of an output overload shall provide automatic recovery for the output voltage.

11.2.2 Short Circuit Protection: Auto Recovery.



MODEL NO. :	HK-AY-240A100-CP	PAGE NO. :	4 OF 15
PART NO. :	HKSC-170003	ISSUED DATE:	2020.03.06
DESCRIPTION :	SWITCHING POWER SUPPLY	REV:	(A2)

## 12.0 ENVIRONMENTAL CONDITIONS

The switching power supply can withstand the following environmental conditions:

12.1 Storage Temperature: -20°C ~ +70°C

Relative Humidity: 10% ~ 95%

12.2 Operation Temperature: 0°C ~ 40°C

Relative Humidity: 10% ~ 95%

## 13.0 EMI / EMC

The switching power supply has approved by the following standards:

FCC PART 15 Class B

EN 55032: 2015, Class B    CISPR 32: 2012 (Ed 2.0)

EN 61000-3-2: 2014    EN 61000-3-3: 2013

IEC 61000-4-2: 2008    IEC 61000-4-3: 2006 +A1: 2007 +A2: 2010

IEC 61000-4-4: 2012    IEC 61000-4-5: 2014    IEC 61000-4-6: 2013

IEC 61000-4-8: 2009    IEC 61000-4-11: 2004 +A1: 2017

AS/NZS CISPR 32: 2015

## 14.0 RELIABILITY AND QUALITY CONTROL

### 14.1 Burn-in

The burn-in test will be performed at least 2 hours at 40 centigrade degrees under full load condition.

### 14.2 MTBF

When the operation is complying with this specification, the switching power supply's MTBF will be 50,000 hours at 25 centigrade degrees.

## 15.0 SAFETY

The switching power supply has approved by the following standards:

UL 62368-1, Audio/video, Information and Communication Technology Equipment - Part 1: Safety Requirements

CSA C22.2 NO. 62368-1-14, Audio/video, Information and Communication Technology Equipment - Part 1: Safety Requirements

EN 62368-1:2014+A11    BS EN 62368-1:2014+A11    AS/NZS 62368.1:2018



# IDEALPOWER

experts in power conversion

MODEL NO. :	HK-AY-240A100-CP	PAGE NO. :	5 OF 15
PART NO. :	HKSC-170003	ISSUED DATE:	2020.03.06
DESCRIPTION :	SWITCHING POWER SUPPLY	REV:	(A2)

## 16. OVERALL DRAWING

UNIT: mm  
COLOR: BLACK

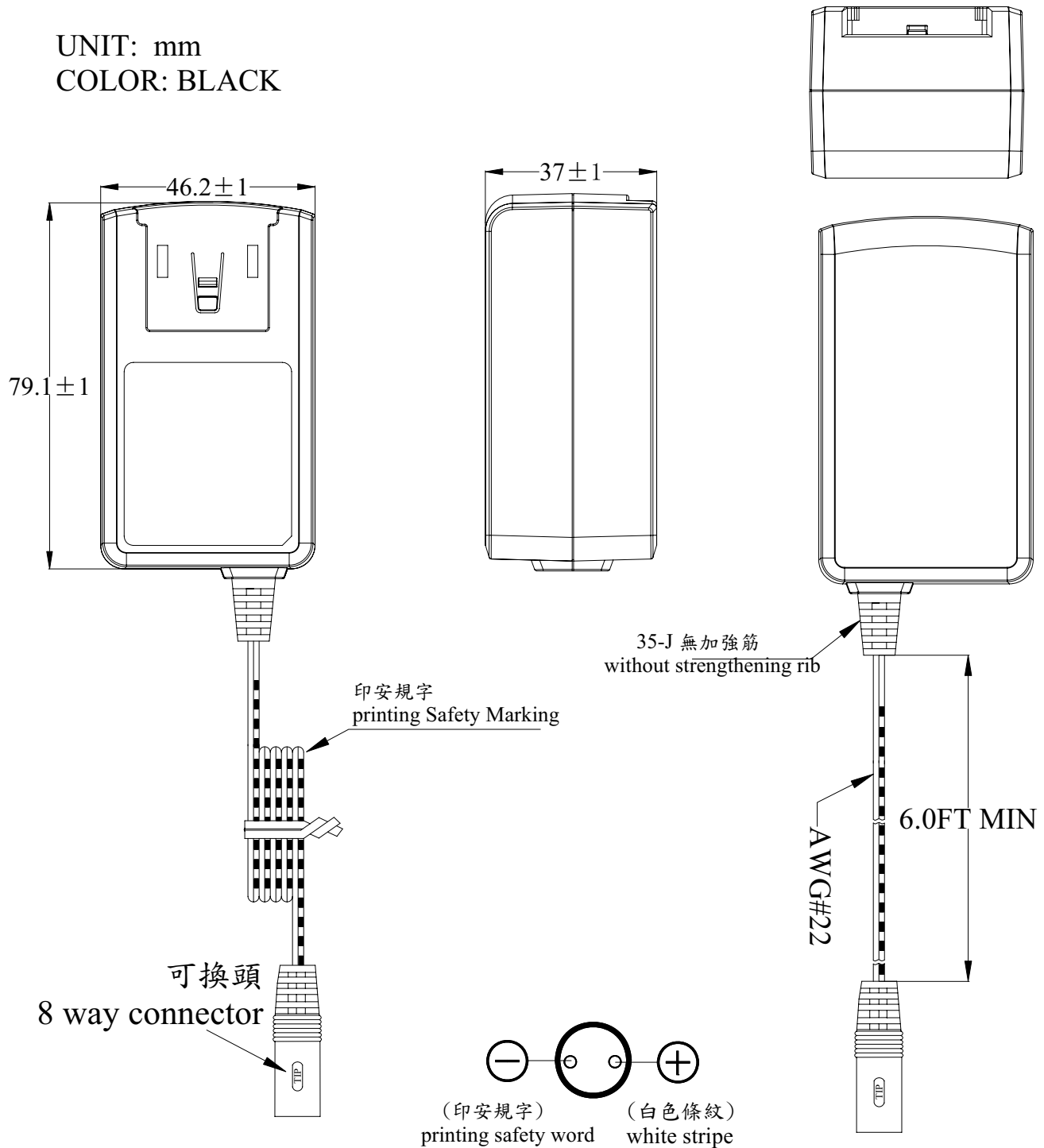



MODEL NO. :	HK-AY-240A100-CP	PAGE NO. :	6 OF 15
PART NO. :	HKSC-170003	ISSUED DATE:	2020.03.06
DESCRIPTION :	SWITCHING POWER SUPPLY	REV:	(A2)

UNIT: mm

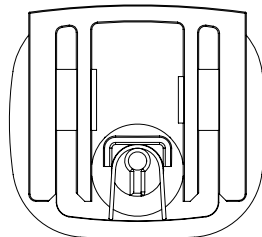
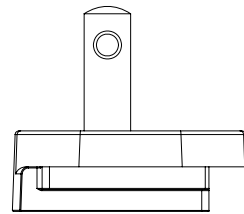
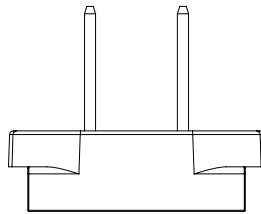
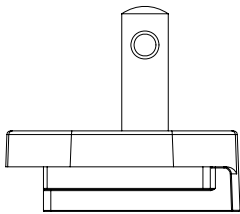
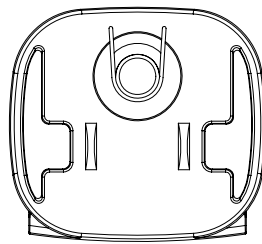

UL





MODEL NO. :	HK-AY-240A100-CP	PAGE NO. :	7 OF 15
PART NO. :	HKSC-170003	ISSUED DATE:	2020.03.06
DESCRIPTION :	SWITCHING POWER SUPPLY	REV:	(A2)

UNIT: mm

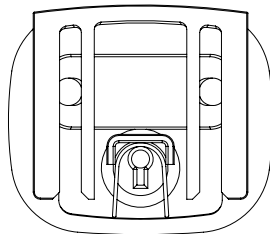
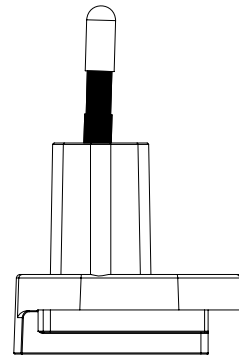
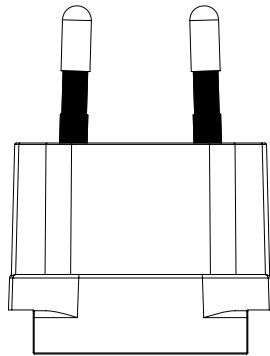
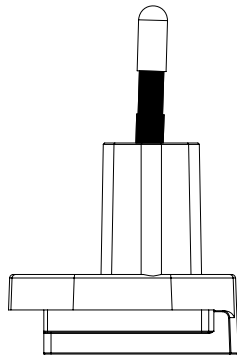
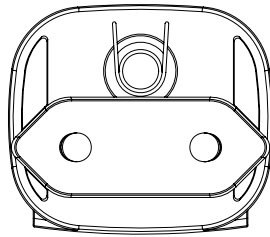

TUV



# IDEALPOWER

experts in power conversion

MODEL NO. :	HK-AY-240A100-CP	PAGE NO. :	8 OF 15
PART NO. :	HKSC-170003	ISSUED DATE:	2020.03.06
DESCRIPTION :	SWITCHING POWER SUPPLY	REV:	(A2)

UNIT: mm

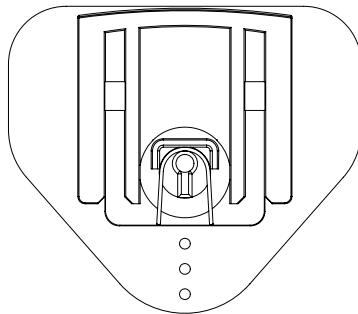
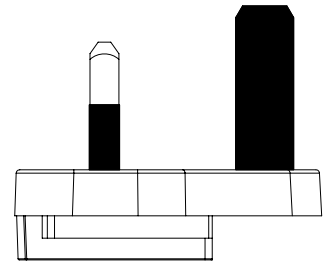
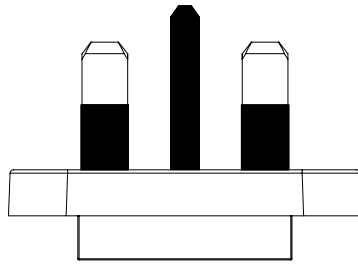
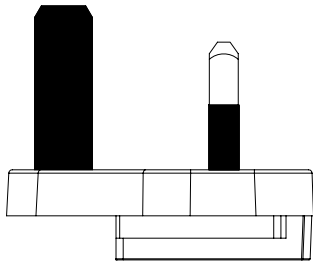
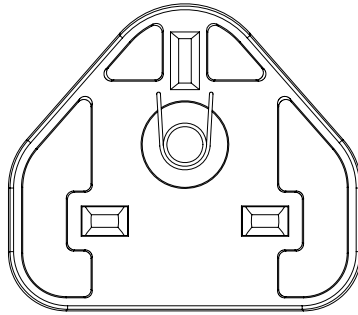

## UK



# IDEALPOWER

experts in power conversion

MODEL NO. :	HK-AY-240A100-CP	PAGE NO. :	9 OF 15
PART NO. :	HKSC-170003	ISSUED DATE:	2020.03.06
DESCRIPTION :	SWITCHING POWER SUPPLY	REV:	(A2)

UNIT: mm

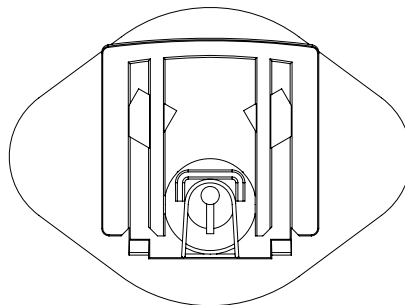
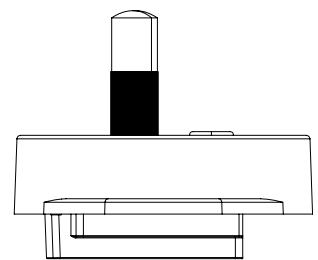
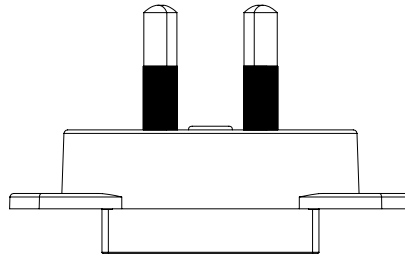
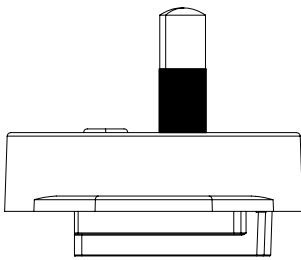
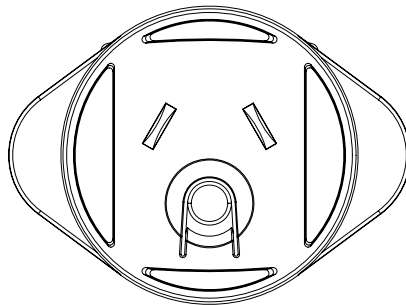

## SAA



# IDEALPOWER

experts in power conversion

MODEL NO. :	HK-AY-240A100-CP	PAGE NO. :	10 OF 15
PART NO. :	HKSC-170003	ISSUED DATE:	2020.03.06
DESCRIPTION :	SWITCHING POWER SUPPLY	REV:	(A2)

UNIT: mm

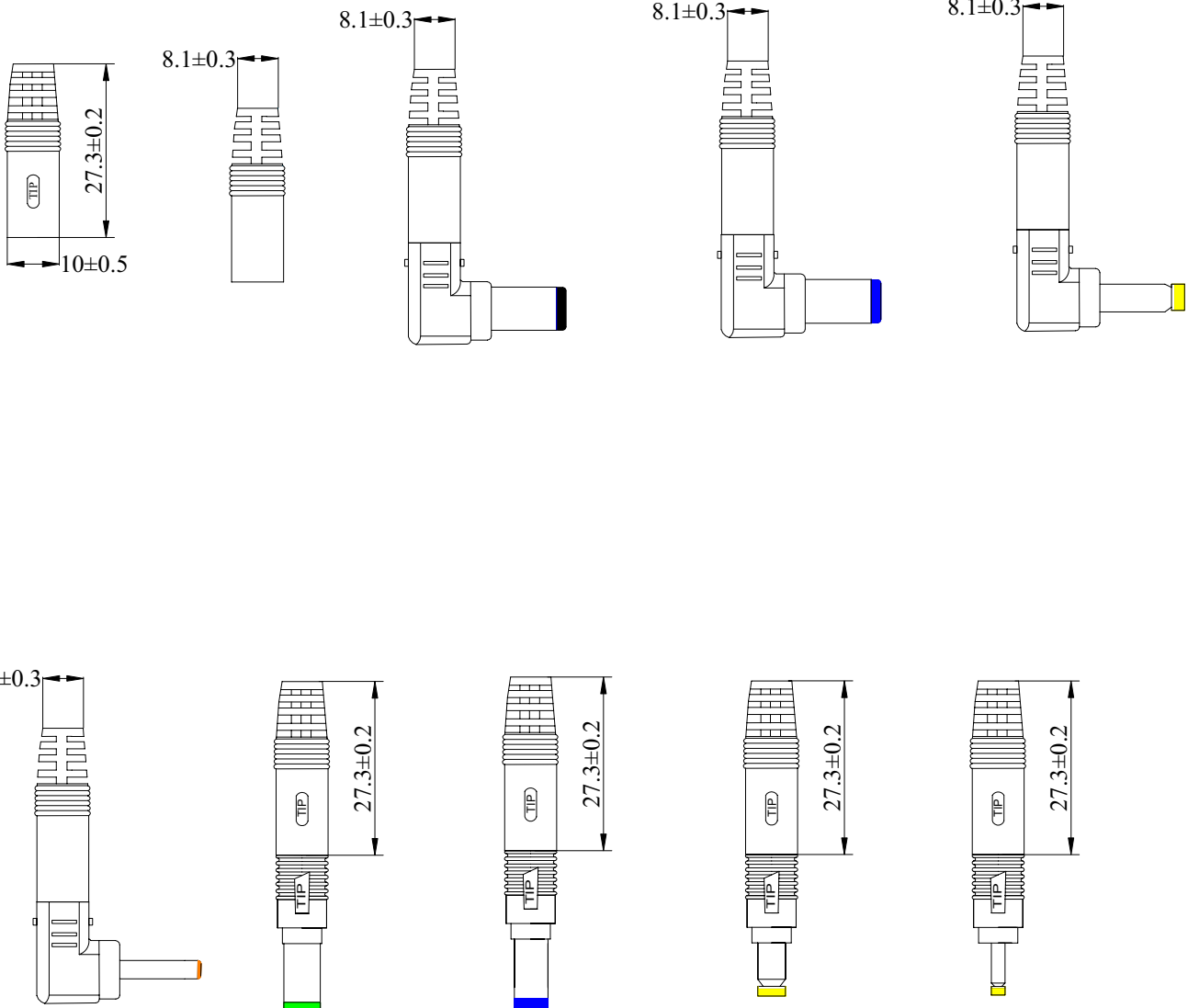



# IDEALPOWER

experts in power conversion

MODEL NO. :	HK-AY-240A100-CP	PAGE NO. :	11 OF 15
PART NO. :	HKSC-170003	ISSUED DATE:	2020.03.06
DESCRIPTION :	SWITCHING POWER SUPPLY	REV:	(A2)

## 17. USE SPECIFICATION

UNIT: mm

### WARNING!

Please don't insert article alone at the wall.

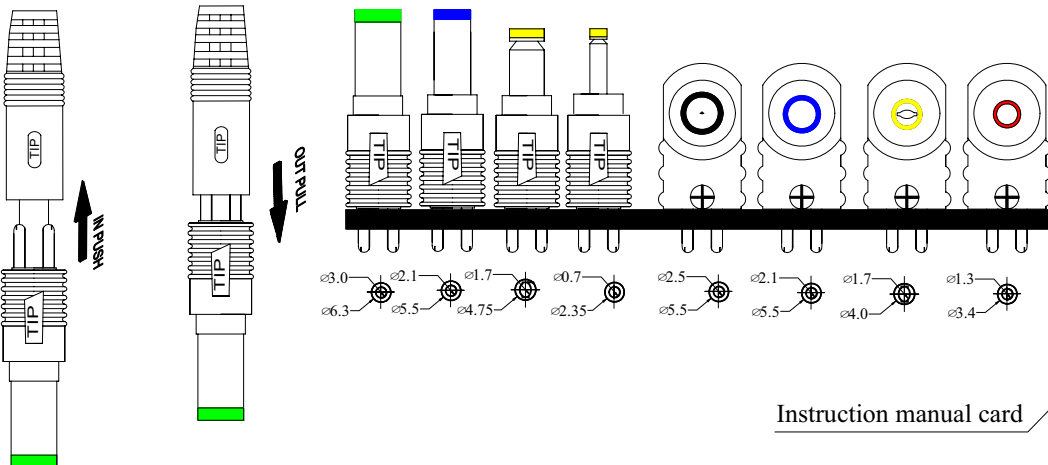
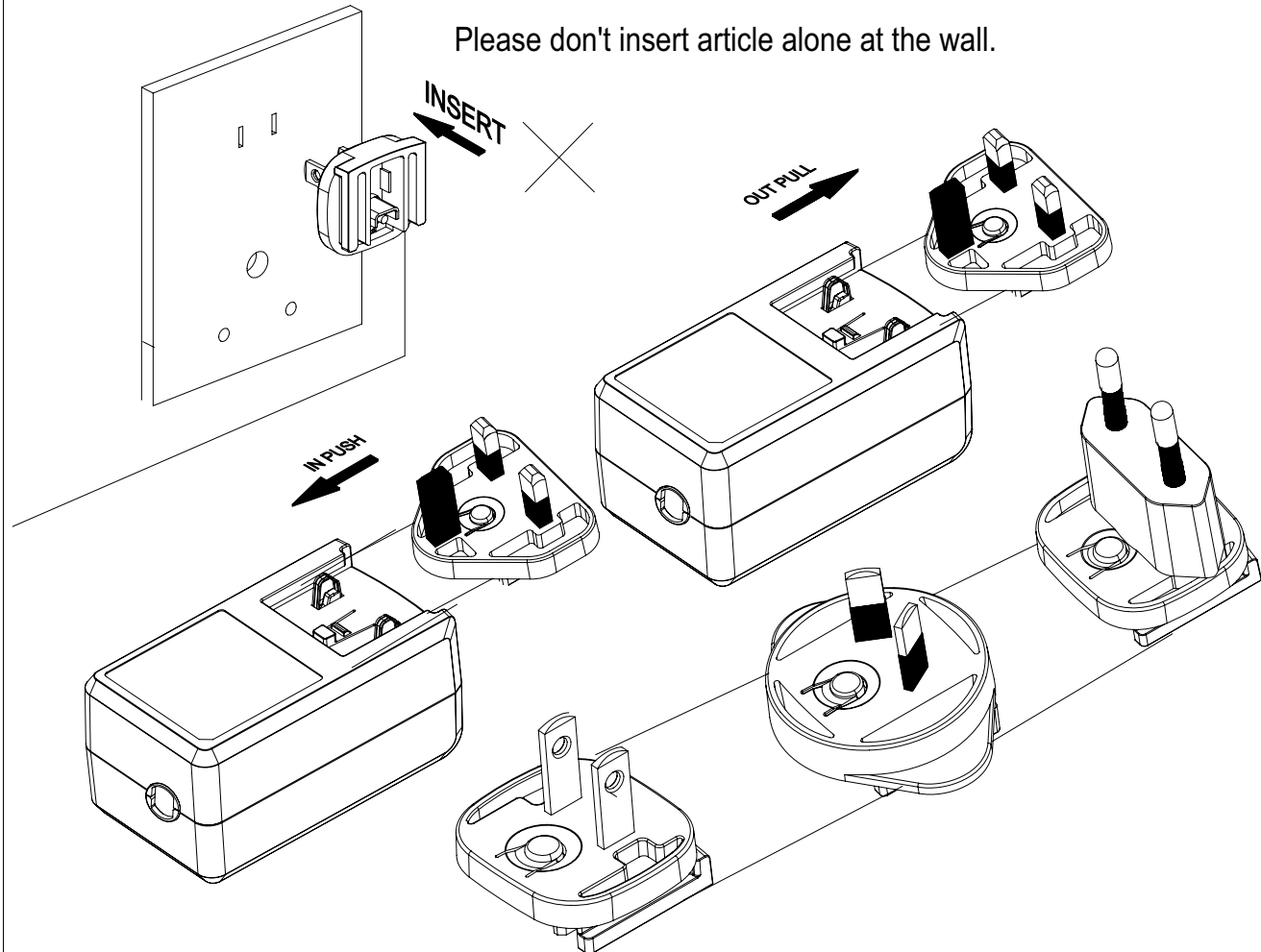

**Output connector instructions.**

Supplied by Ideal Power Ltd, Acorn House, Tree Beech Enterprise Park, Gunn, Barnstaple, Devon, England EX32 7NZ Tel. +44 (0) 845 2603400

Please ensure the correct polarity is observed before connecting to any user equipment.

Positive Inner

Positive Outer

Instruction manual card

MODEL NO. :	HK-AY-240A100-CP	PAGE NO. :	12 OF 15
PART NO. :	HKSC-170003	ISSUED DATE:	2020.03.06
DESCRIPTION :	SWITCHING POWER SUPPLY	REV:	(A2)

## 18. PACKING

### 18.1 Inner Box

UNIT: mm

BOX(  Normal BOX  Corrugated BOX)

Length: 143

Width: 70

Height: 60

Label: 1

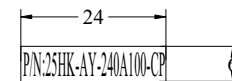

Label: 2

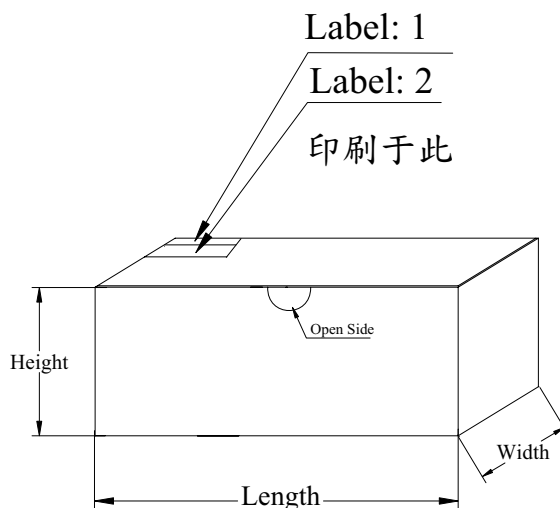
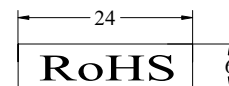

### NOTICE:

Its probably different from the white box of the sample and the figure dimension.  
The white box is used to pack during product.

注意: 樣品使用的小白盒尺寸可能與此圖面尺寸不同, 此圖面尺寸是用于生產時的包裝。



MODEL NO. :	HK-AY-240A100-CP	PAGE NO. :	13 OF 15
PART NO. :	HKSC-170003	ISSUED DATE:	2020.03.06
DESCRIPTION :	SWITCHING POWER SUPPLY	REV:	(A2)

## 18. PACKING

### 18.2 Carton

UNIT: mm

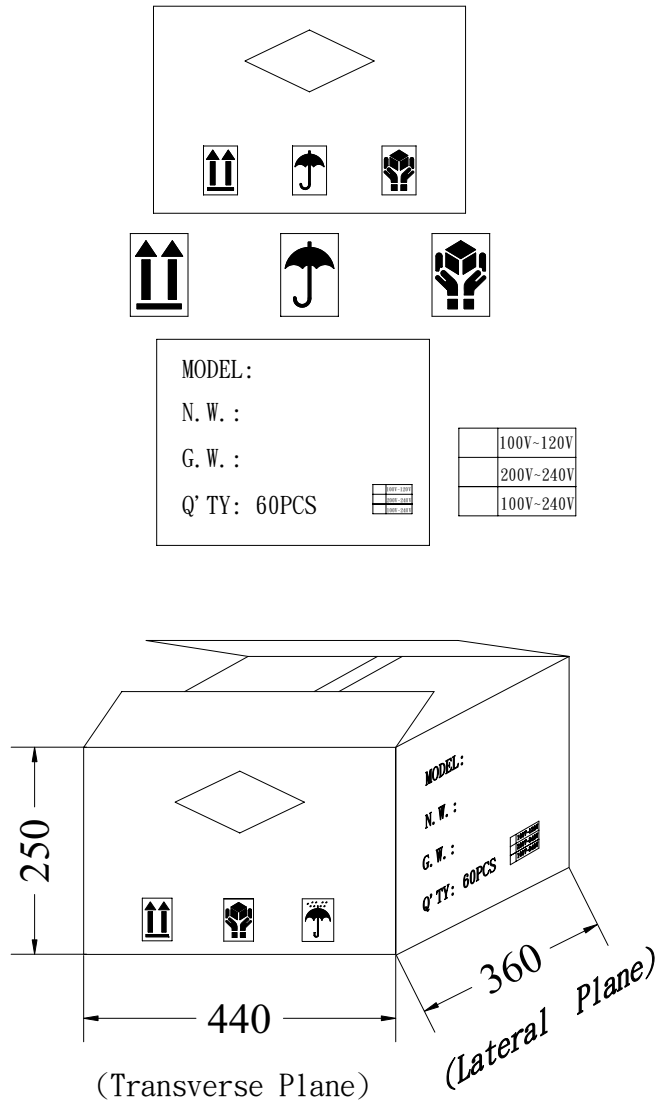

MODEL NO. :	HK-AY-240A100-CP	PAGE NO. :	14 OF 15
PART NO. :	HKSC-170003	ISSUED DATE:	2020.03.06
DESCRIPTION :	SWITCHING POWER SUPPLY	REV:	(A2)

### 19. MARKING

100# CPC 壓花底+上光 NAME-PLATE:WHITE CHARACTERS BLACK BACKGROUND.

UNIT: mm MMYYS  
 month      year  
 made in China  
 by Hon-kwang

