

BASE CAGE DETAILS

(APPLIES TO ALL CAGES IN THIS DRAWING)

747680212
SHOWN

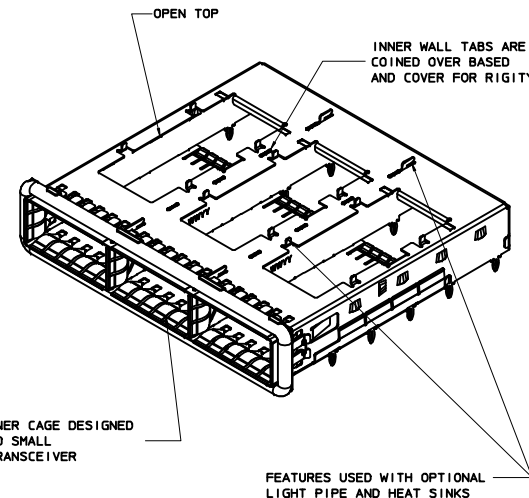
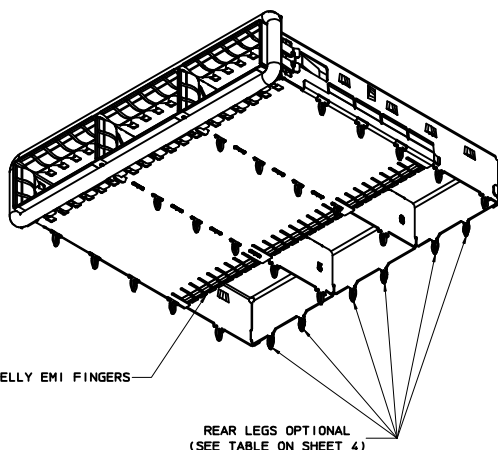
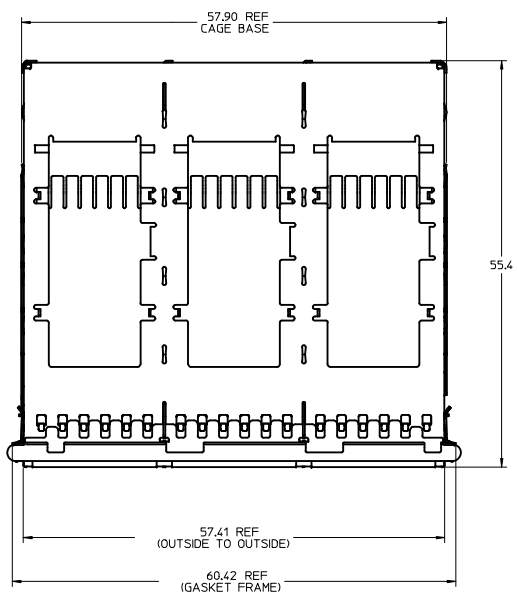

DIMENSION OF EACH INNER CAGE DESIGNED TO FUNCTION WITH QUAD SMALL FORM-FACTOR (QSFP) TRANSCEIVER

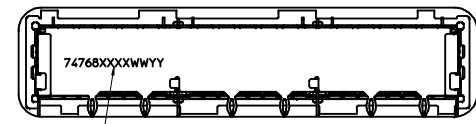
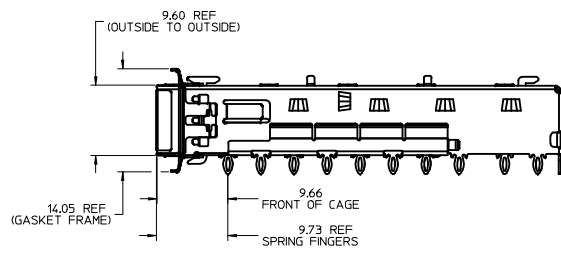
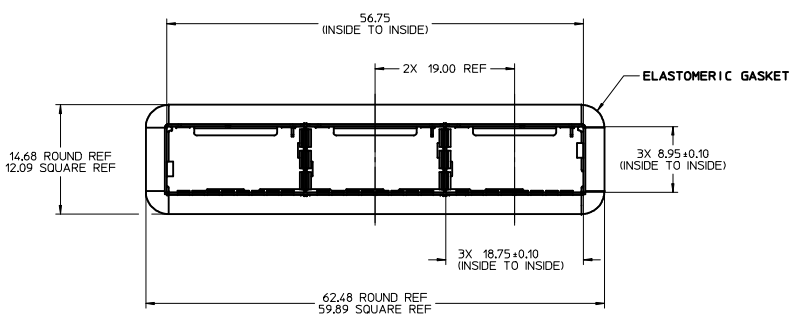

PART NO. AND WEEK/YEAR DATE CODE TO BE PRINTED ON BACK OF COMPLETED CAGE ASSEMBLY APPROXIMATELY AS SHOWN. SEE TABLE BELOW FOR DATE CODE INFORMATION.

NOTE:
ELASTOMER GASKET REMOVED FOR CLARITY

WEEK/YEAR DATE CODE TABLE	
WW	01 THRU 52 EXAMPLE: 01 = FIRST WEEK OF YEAR 52 = LAST WEEK OF YEAR
YY	12, 13, 14 ETC. EXAMPLE: YEAR 2014 = 14

NOTE:
INNER SPRING FINGERS HAVE BEEN REMOVED FOR CLARITY

- NOTES:
1. QSFP+ ASSEMBLES ALSO AVAILABLE AND 1X1 74750 SERIES, 1X2 (74767 SERIES), 1X4 (74769 SERIES) AND 1X6 (74771 SERIES) CONFIGURATIONS.
 2. MATERIAL:
COVER/CLIP: STAINLESS STEEL
LIGHT PIPES: POLYCARBONATE (94-V0 RATED)
HEAT SINKS: ALUMINUM
CAGE: COPPER ALLOY
 3. NO RoHS EXEMPTIONS
 4. CUSTOM HEATSINKS AVAILABLE UPON REQUEST

SEE REV HISTORY IEC NO: CPG2015-6002 2015/05/18 DRWN:JERWIN 2015/05/18 CHKD:EMENA 2015/05/18 APPR:K.LLOYD	QUALITY SYMBOLS	GENERAL TOLERANCES (UNLESS SPECIFIED)	DIMENSION STYLE	SCALE	DESIGN UNITS	THIRD ANGLE PROJECTION
	▽=0	4 PLACES ± mm INCH	MM ONLY	2:1	METRIC	☉
	▽=0	3 PLACES ± --- ± ---				
	▽=0	2 PLACES ±0.15 ± ---				
		1 PLACE ±0.25 ± ---				
		0 PLACE ± --- ± ---				
		ANGULAR ± 1 °				
		DRAFT WHERE APPLICABLE MUST REMAIN WITHIN DIMENSIONS				
			MATERIAL NO.	DOCUMENT NO.		
			SHT 5, 6 & 7	SD-74768-0501		
			SIZE D			
			THIS DRAWING CONTAINS INFORMATION THAT IS PROPRIETARY TO MOLEX INCORPORATED AND SHOULD NOT BE USED WITHOUT WRITTEN PERMISSION			

CAGE ASSEMBLY OPTIONS

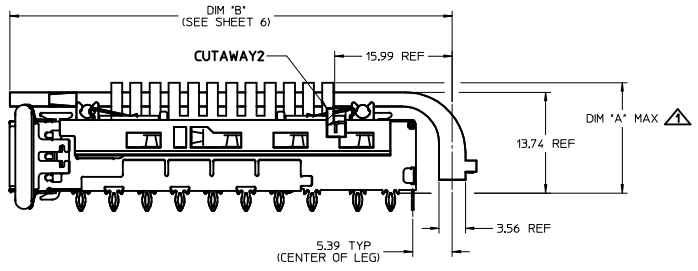

PCI HEAT SINK
(PIN STYLE)

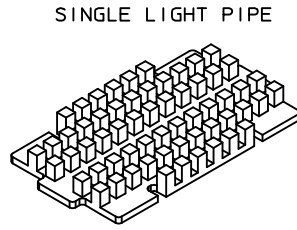

SINGLE LIGHT PIPE

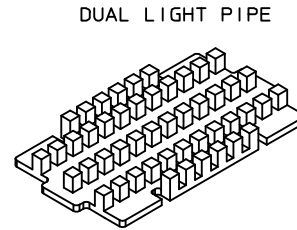

DUAL LIGHT PIPE

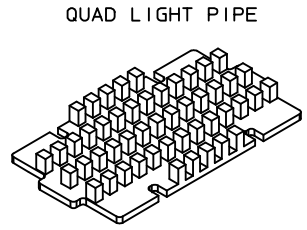

QUAD LIGHT PIPE

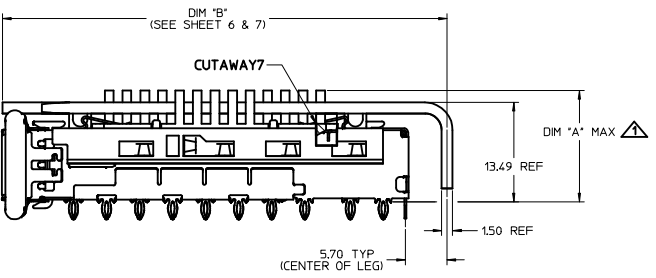

SAN HEAT SINK
(PIN STYLE)

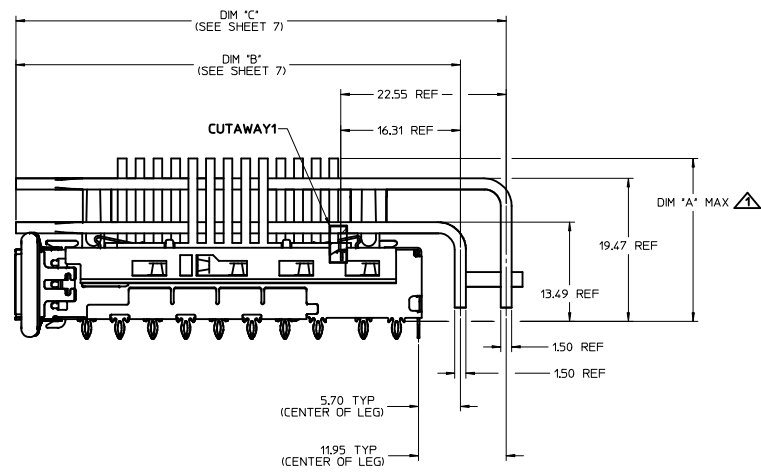
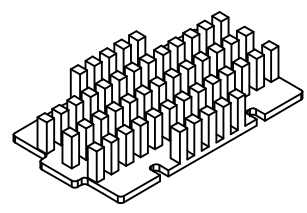
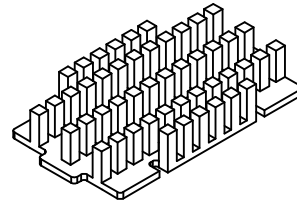
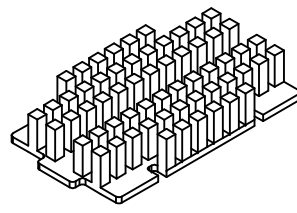

NET HEAT SINK
(PIN STYLE)

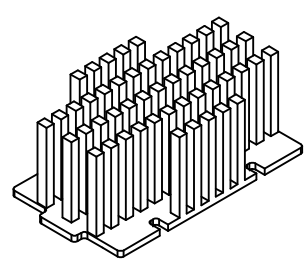
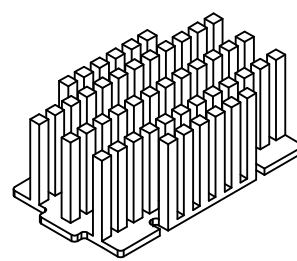
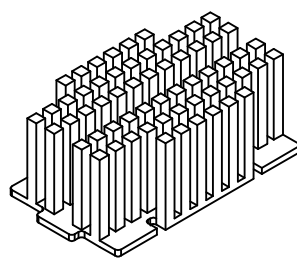

HEATSINK HEIGHT OPTIONS

OVERALL HEATSINK HEIGHT	DIM 'A'
PCI	13.7
SAN	16.0
NET	23.0

NOTE:
1) FOR LIGHT PIPE OPTIONS SEE SHEET 3.

▲ HEIGHT OF HEATSINK WITH MODULE INSERTED.
DIMENSION MAY BE LESS DUE TO MODULE AND HEATSINK VARIATIONS.

SEE REV HISTORY IEC NO: CPG2015-6002 DRAWN BY: JERWIN 2015/05/18 CHECKED BY: CHYKMEENA 2015/05/18 APPR: KLOYD 2015/05/18 REV DESCRIPTION	QUALITY SYMBOLS	GENERAL TOLERANCES (UNLESS SPECIFIED)	DIMENSION STYLE	SCALE	DESIGN UNITS	THIRD ANGLE PROJECTION
	▽=0	mm INCH	MM ONLY	3.5:1	METRIC	☉
	▽=0	4 PLACES ± --- ± ---				
	▽=0	3 PLACES ± --- ± ---				
		ANGULAR ± 1°				
		DRAFT WHERE APPLICABLE MUST REMAIN WITHIN DIMENSIONS				
			MATERIAL NO.	DOCUMENT NO.		
			SHT 5, 6 & 7	SD-74768-0501		
			THIS DRAWING CONTAINS INFORMATION THAT IS PROPRIETARY TO MOLEX INCORPORATED AND SHOULD NOT BE USED WITHOUT WRITTEN PERMISSION			

TITLE
QSFP+ 1X3 GANGED CAGE ASSEMBLIES

molex

SHEET NO.
2 OF 12

CAGE ASSEMBLY OPTIONS (CONT.)

SINGLE LIGHT PIPE

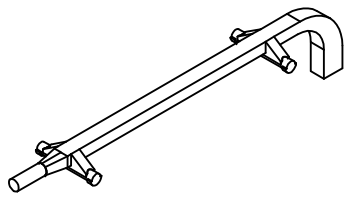

DUAL LIGHT PIPE

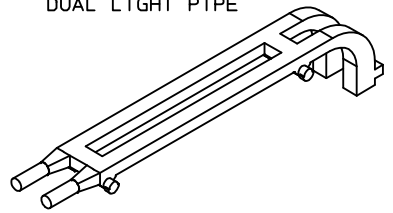

QUAD LIGHT PIPE

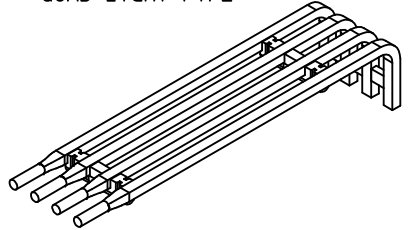

QUAD LIGHT PIPE (SQUARE)

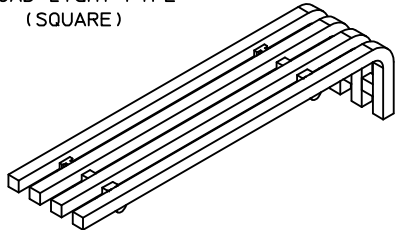

QUAD LIGHT PIPE (FLARED)

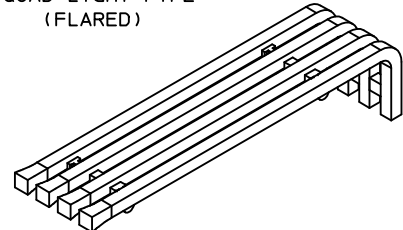

2 ROW QUAD LIGHT PIPE

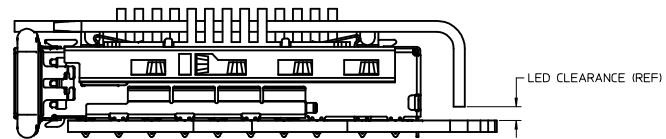
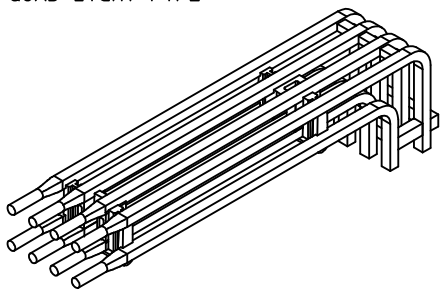

LED CLEARANCE (REF)

LIGHT PIPE	LED CLEARANCE (REF)
SINGLE	1.875
DUAL	1.875
QUAD (ROUND TIP)	1.875
QUAD (SQUARE TIP)	1.875
QUAD (FLARED TIP)	1.725
QUAD (2 ROW)	1.875

NOTE:
FOR HEATSINK OPTIONS SEE SHEET 2.

SEE REV HISTORY IEC NO: CPG2015-6002 DRAWN: JERWIN 2015/05/18 CHECKED: MEREDINA 2015/05/18 APPR: KLOYD 2015/05/18	QUALITY SYMBOLS ∇=0 ∇=0 ∇=0	GENERAL TOLERANCES (UNLESS SPECIFIED)		DIMENSION STYLE MM ONLY	SCALE 3:1	DESIGN UNITS METRIC	THIRD ANGLE PROJECTION	
		4 PLACES ± mm ± INCH	3 PLACES ± --- ± ---	DRAWN BY JERWIN	DATE 2011/05/11	TITLE QSFP+ 1X3 GANGED CAGE ASSEMBLIES		
		2 PLACES ± 0.15 ± ---	1 PLACE ± 0.25 ± ---	CHECKED BY CHIRSCHY	DATE 2011/05/11	MATERIAL NO. SHT 5, 6 & 7		
		0 PLACE ± --- ± ---	ANGULAR ± 1 °	APPROVED BY	DATE	DOCUMENT NO. SD-74768-0501	SHEET NO. 3 OF 12	

THIS DRAWING CONTAINS INFORMATION THAT IS PROPRIETARY TO MOLEX INCORPORATED AND SHOULD NOT BE USED WITHOUT WRITTEN PERMISSION

CAGE ASSEMBLY OPTIONS (CONT.)

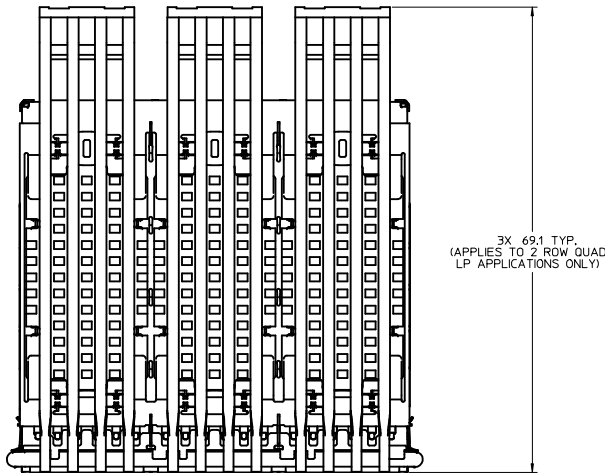
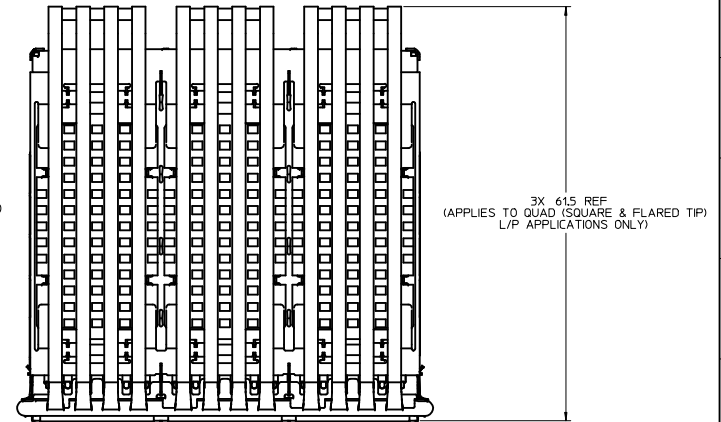
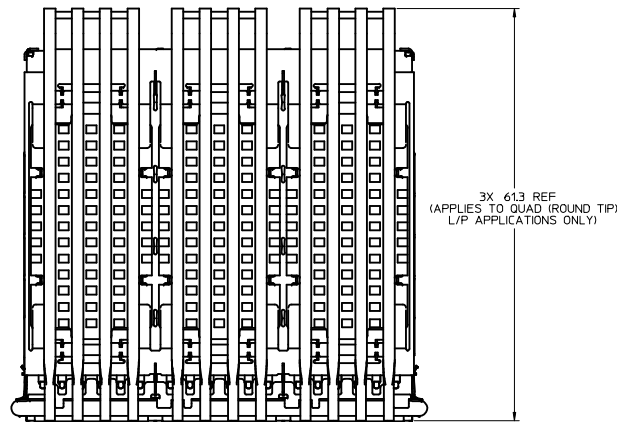
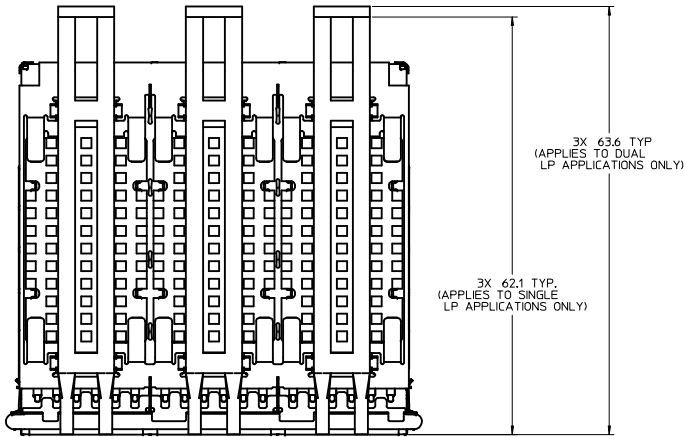

REAR LEG OPTIONS

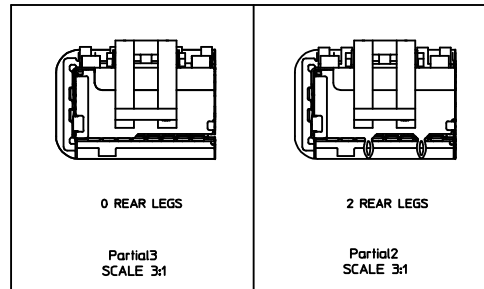

ELASTOMERIC GASKET OPTIONS

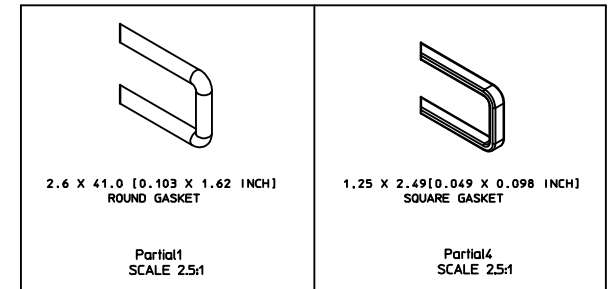

SEE REV HISTORY IEC NO: CPG2015-6002 DRAWN BY: JERWIN 2015/05/18 CHECKED BY: CHYKEDINA 2015/05/18 APPR: KLOYD 2015/05/18	QUALITY SYMBOLS ▽=0 ▽=0 ▽=0	GENERAL TOLERANCES (UNLESS SPECIFIED) <table border="1"> <thead> <tr> <th></th> <th>mm</th> <th>INCH</th> </tr> </thead> <tbody> <tr> <td>4 PLACES</td> <td>± 0.15</td> <td>± 0.006</td> </tr> <tr> <td>3 PLACES</td> <td>± 0.25</td> <td>± 0.010</td> </tr> <tr> <td>2 PLACES</td> <td>± 0.38</td> <td>± 0.015</td> </tr> <tr> <td>1 PLACE</td> <td>± 0.51</td> <td>± 0.020</td> </tr> <tr> <td>0 PLACE</td> <td>± 0.64</td> <td>± 0.025</td> </tr> </tbody> </table> ANGULAR ± 1 ° DRAFT WHERE APPLICABLE MUST REMAIN WITHIN DIMENSIONS		mm	INCH	4 PLACES	± 0.15	± 0.006	3 PLACES	± 0.25	± 0.010	2 PLACES	± 0.38	± 0.015	1 PLACE	± 0.51	± 0.020	0 PLACE	± 0.64	± 0.025	DIMENSION STYLE MM ONLY SCALE 3:1 DESIGN UNITS METRIC THIRD ANGLE PROJECTION	DRAWN BY: JERWIN DATE: 2011/05/11 CHECKED BY: CHIRSCHY DATE: 2011/05/11 APPROVED BY:	TITLE QSFP+ 1X3 GANGED CAGE ASSEMBLIES
		mm	INCH																				
	4 PLACES	± 0.15	± 0.006																				
	3 PLACES	± 0.25	± 0.010																				
2 PLACES	± 0.38	± 0.015																					
1 PLACE	± 0.51	± 0.020																					
0 PLACE	± 0.64	± 0.025																					
MATERIAL NO. SHT 5, 6 & 7	DOCUMENT NO. SD-74768-0501	SHEET NO. 4 OF 12	moxlex THIS DRAWING CONTAINS INFORMATION THAT IS PROPRIETARY TO MOLEX INCORPORATED AND SHOULD NOT BE USED WITHOUT WRITTEN PERMISSION																				
SIZE D																							

PART NUMBER SELECTION

NO HEAT SINKS
NO LIGHT PIPES

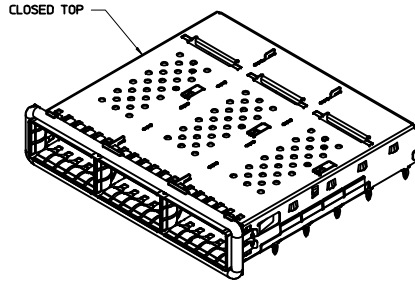

MOLEX P/N	# OF REAR LEGS PER PORT
747680223	2
747680226	2

NO HEAT SINKS
NO LIGHT PIPES

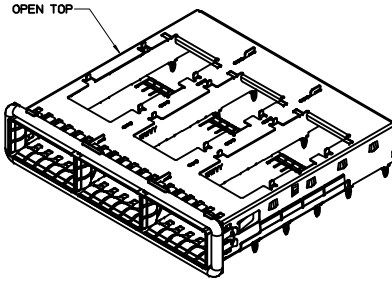

MOLEX P/N	GASKET STYLE	# OF REAR LEGS PER PORT
747680204	SQUARE	0
747680205	SQUARE	2
747680206	ROUND	0
747680207	ROUND	2
747680208	SQUARE	2
747680209	SQUARE	0
747680210	ROUND	0
747680212	ROUND	2

WITH HEAT SINKS
NO LIGHT PIPES

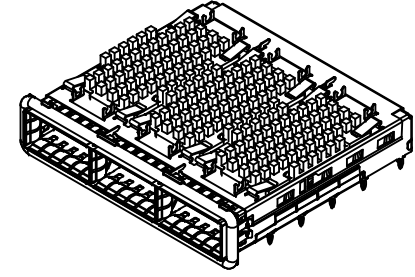

MOLEX P/N	GASKET STYLE	HS	# OF REAR LEGS PER PORT
747680505	ROUND	PCI	0
747680506	ROUND	SAN	2
747680507	ROUND	NET	2
747680514	ROUND	PCI	2
747680516	SQUARE	PCI	2
747680605	ROUND	PCI	0
747680606	ROUND	SAN	0
747680607	ROUND	NET	0

SEE REV HISTORY IEC NO: CPG2015-6002 DRAWN: JERWIN 2015/05/18 CHECKED: CHYKORIEDINA 2015/05/18 APPR: K LLOYD 2015/05/18 REV DESCRIPTION	QUALITY SYMBOLS	GENERAL TOLERANCES (UNLESS SPECIFIED)	DIMENSION STYLE	SCALE	DESIGN UNITS	THIRD ANGLE PROJECTION
	∇=0 ∇=0 ∇=0	mm INCH 4 PLACES ± --- ± --- 3 PLACES ± --- ± --- 2 PLACES ± 0.15 ± --- 1 PLACE ± 0.25 ± --- 0 PLACE ± --- ± ---	MM ONLY	2:1	METRIC	TITLE OSFP+ 1X3 GANGED CAGE ASSEMBLIES
	ANGULAR ± 1° DRAFT WHERE APPLICABLE MUST REMAIN WITHIN DIMENSIONS	MATERIAL NO. SEE CHART	DOCUMENT NO. SD-74768-0501	SHEET NO. 5 OF 12		
	THIS DRAWING CONTAINS INFORMATION THAT IS PROPRIETARY TO MOLEX INCORPORATED AND SHOULD NOT BE USED WITHOUT WRITTEN PERMISSION					

PART NUMBER SELECTION (CON'T)

SINGLE LIGHT PIPE
WITH HEAT SINKS

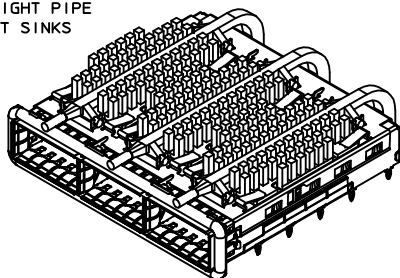

MOLEX P/N	LP	TIP STYLE	HS	* OF REAR LEGS PER PORT	DIM 'B'
747680501	SINGLE	ROUND	SAN	2	60.25
747680502	SINGLE	ROUND	NET	2	60.25
747680601	SINGLE	ROUND	SAN	0	60.25
747680602	SINGLE	ROUND	NET	0	60.25

DUAL LIGHT PIPE
WITH HEAT SINKS

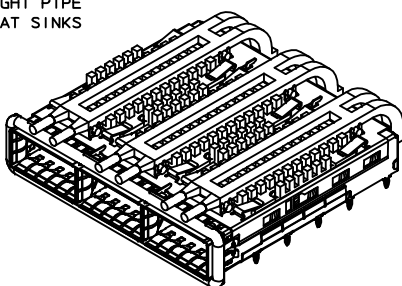

MOLEX P/N	LP	TIP STYLE	HS	* OF REAR LEGS PER PORT	DIM 'B'
747680503	DUAL	ROUND	SAN	2	60.25
747680504	DUAL	ROUND	NET	2	60.25
747680511	DUAL	ROUND	PCI	2	60.25
747680515	DUAL	ROUND	SAN	2	60.25
747680603	DUAL	ROUND	SAN	0	60.25
747680604	DUAL	ROUND	NET	0	60.25

QUAD LIGHT PIPE
WITH HEAT SINKS

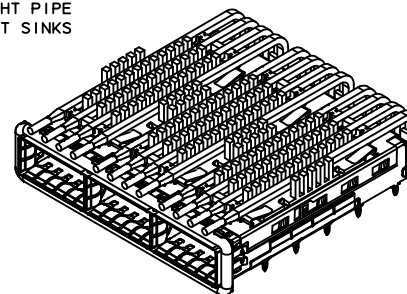

MOLEX P/N	LP	TIP STYLE	HS	* OF REAR LEGS PER PORT	DIM 'B'
747680509	QUAD	ROUND	SAN	2	60.54
747680517	QUAD	ROUND	PCI	2	60.54
747680518	QUAD	ROUND	SAN	2	60.54
747680519	QUAD	ROUND	NET	2	60.54
747680520	QUAD	ROUND	PCI	0	60.54
747680521	QUAD	ROUND	SAN	0	60.54
747680522	QUAD	ROUND	NET	0	60.54
747680537	QUAD	ROUND	PCI	2	60.54
747680538	QUAD	ROUND	SAN	2	60.54
747680539	QUAD	ROUND	NET	2	60.54
747680540	QUAD	ROUND	PCI	0	60.54
747680541	QUAD	ROUND	SAN	0	60.54
747680542	QUAD	ROUND	NET	0	60.54

SEE REV HISTORY IEC NO: CPG2015-6002 DRAWN: JERWIN 2015/05/18 CHECKED: CHYKHEMEDINA 2015/05/18 APPROVED: KILLOYD 2015/05/18	QUALITY SYMBOLS ▽=0 ▽=0 ▽=0	GENERAL TOLERANCES (UNLESS SPECIFIED) <table border="1" style="width: 100%; border-collapse: collapse;"> <thead> <tr> <th></th> <th>mm</th> <th>INCH</th> </tr> </thead> <tbody> <tr> <td>4 PLACES</td> <td>± ---</td> <td>± ---</td> </tr> <tr> <td>3 PLACES</td> <td>± ---</td> <td>± ---</td> </tr> <tr> <td>2 PLACES</td> <td>± 0.15</td> <td>± ---</td> </tr> <tr> <td>1 PLACE</td> <td>± 0.25</td> <td>± ---</td> </tr> <tr> <td>0 PLACE</td> <td>± ---</td> <td>± ---</td> </tr> </tbody> </table> ANGULAR ± 1° DRAFT WHERE APPLICABLE MUST REMAIN WITHIN DIMENSIONS		mm	INCH	4 PLACES	± ---	± ---	3 PLACES	± ---	± ---	2 PLACES	± 0.15	± ---	1 PLACE	± 0.25	± ---	0 PLACE	± ---	± ---	DIMENSION STYLE MM ONLY	SCALE 2:1	DESIGN UNITS METRIC	THIRD ANGLE PROJECTION
		mm	INCH																					
	4 PLACES	± ---	± ---																					
	3 PLACES	± ---	± ---																					
2 PLACES	± 0.15	± ---																						
1 PLACE	± 0.25	± ---																						
0 PLACE	± ---	± ---																						
DRAWN BY: JERWIN CHECKED BY: CHIRSCHY APPROVED BY:		DATE: 2011/05/11 DATE: 2011/05/11 DATE:		TITLE QSFP+ 1X3 GANGED CAGE ASSEMBLIES																				
MATERIAL NO. SEE CHART		DOCUMENT NO. SD-74768-0501																						
SIZE D THIS DRAWING CONTAINS INFORMATION THAT IS PROPRIETARY TO MOLEX INCORPORATED AND SHOULD NOT BE USED WITHOUT WRITTEN PERMISSION						SHEET NO. 6 OF 12																		

PART NUMBER SELECTION (CON'T)

QUAD LIGHT PIPE WITH HEAT SINKS

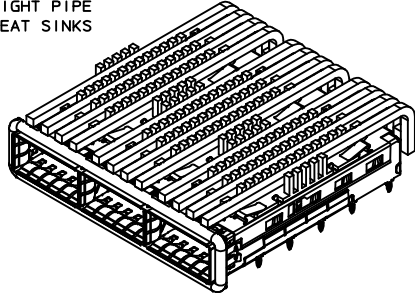

MOLEX P/N	LP	TIP STYLE	HS	# OF REAR LEGS PER PORT	DIM 'B'
747680531	QUAD	SQUARE	PCI	2	60.54
747680532	QUAD	SQUARE	SAN	2	60.54
747680533	QUAD	SQUARE	NET	2	60.54
747680534	QUAD	SQUARE	PCI	0	60.54
747680535	QUAD	SQUARE	SAN	0	60.54
747680536	QUAD	SQUARE	NET	0	60.54

QUAD LIGHT PIPE WITH HEAT SINKS

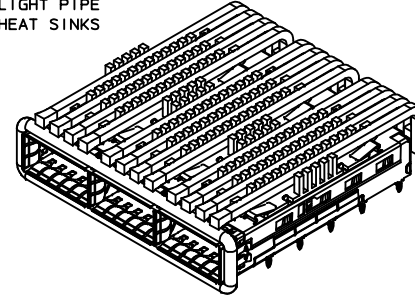

MOLEX P/N	LP	TIP STYLE	GASKET STYLE	HS	# OF REAR LEGS PER PORT	DIM 'B'
747680523	QUAD	FLARED	ROUND	PCI	2	60.54
747680524	QUAD	FLARED	ROUND	SAN	2	60.54
747680525	QUAD	FLARED	ROUND	NET	2	60.54
747680526	QUAD	FLARED	ROUND	PCI	0	60.54
747680527	QUAD	FLARED	ROUND	SAN	0	60.54
747680528	QUAD	FLARED	ROUND	NET	0	60.54
747680543	QUAD	FLARED	SQUARE	PCI	2	60.54
747680544	QUAD	FLARED	SQUARE	SAN	2	60.54
747680545	QUAD	FLARED	SQUARE	NET	2	60.54
747680546	QUAD	FLARED	SQUARE	PCI	0	60.54
747680547	QUAD	FLARED	SQUARE	SAN	0	60.54
747680548	QUAD	FLARED	SQUARE	NET	0	60.54

2 ROW QUAD LIGHT PIPE WITH HEAT SINKS

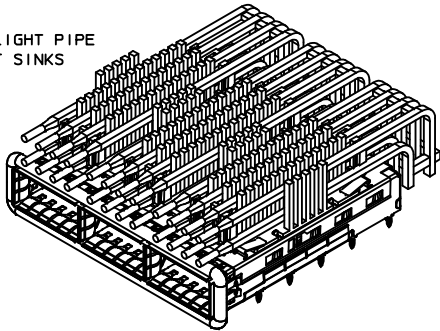

MOLEX P/N	LP	TIP STYLE	GASKET STYLE	HS	# OF REAR LEGS PER PORT	DIM 'B'	DIM 'C'
747680529	2 ROW QUAD	ROUND	ROUND	NET	0	60.54	66.78
747680530	2 ROW QUAD	ROUND	ROUND	NET	2	60.54	66.78
747680549	2 ROW QUAD	ROUND	SQUARE	NET	0	60.54	66.78
747680550	2 ROW QUAD	ROUND	SQUARE	NET	2	60.54	66.78
747680551	2 ROW QUAD	ROUND	SQUARE	SAN	0	60.54	66.78
747680552	2 ROW QUAD	ROUND	SQUARE	SAN	2	60.54	66.78

SEE REV HISTORY IEC NO: CPG2015-6002 DRAWN: JERWIN 2015/05/18 CHECKED: MARIANA 2015/05/18 APPR: K LLOYD 2015/05/18	QUALITY SYMBOLS ∇=0 ∇=0 ∇=0	GENERAL TOLERANCES (UNLESS SPECIFIED)		DIMENSION STYLE MM ONLY	SCALE 3:1	DESIGN UNITS METRIC	THIRD ANGLE PROJECTION	
		4 PLACES ± mm INCH 3 PLACES ± --- ± ---		DRAWN BY JERWIN		DATE 2011/05/11		OSFP+ 1X3 GANGED CAGE ASSEMBLIES molex MATERIAL NO. SEE TABLE DOCUMENT NO. SD-74768-0501
		2 PLACES ± 0.15 1 PLACE ± 0.25		CHECKED BY CHIRSCHY		DATE 2011/05/11		
		0 PLACE ± --- ± ---		APPROVED BY DATE		SHEET NO. 7 OF 12		
ANGULAR ± 1° DRAFT WHERE APPLICABLE MUST REMAIN WITHIN DIMENSIONS		SIZE D		THIS DRAWING CONTAINS INFORMATION THAT IS PROPRIETARY TO MOLEX INCORPORATED AND SHOULD NOT BE USED WITHOUT WRITTEN PERMISSION				

PCB LAYOUT FOR SINGLE SIDED MOUNTING

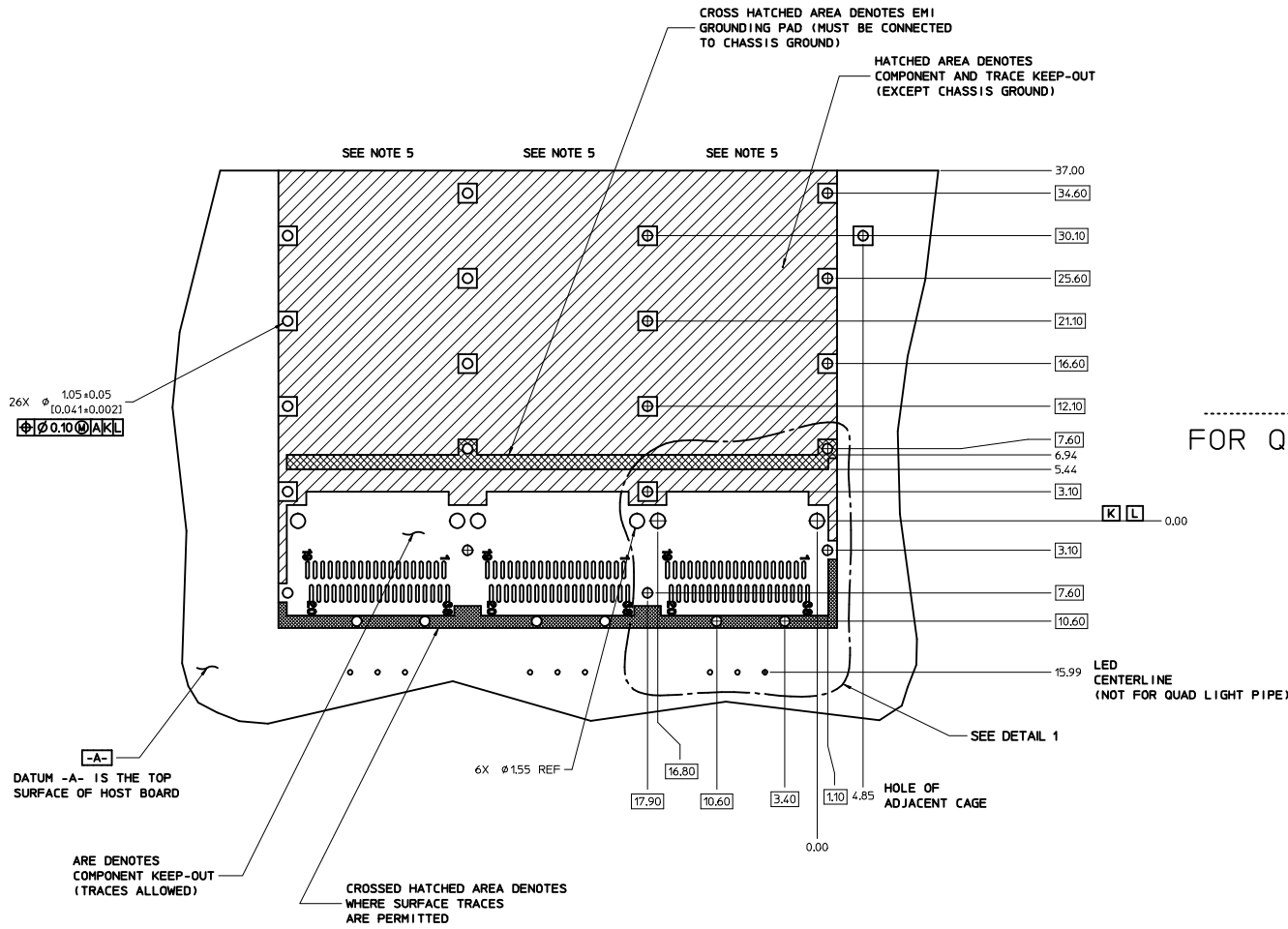

- NOTES:**
- PADS AND VIAS CONNECT TO CHASSIS GROUND (RECOMMEND PADS TO BE 2.00mm SQUARE)
 - RECOMMENDED THRU HOLE PLATING INCLUDES HASL, OSP, OR IMMERSION (GOLD, SILVER, OR TIN).
 - CONNECTOR PAD LAYOUT PER QSFP MSA WILL ACCOMMODATE MOLEX CONNECTOR 75586-0010 OR 75586-0011.
 - SINGLE SIDE BOARD THICKNESS:
 NOMINAL: 1.60 [0.062"]
 MINIMUM: 1.44 [0.057"]
 - SPACING BETWEEN PORTS IS 19.00 [0.748"].
 - LED SHOULD BE PLACED RELATIVE TO THE QSFP CONNECTOR POST HOLES

HOST CONNECTOR DETAIL

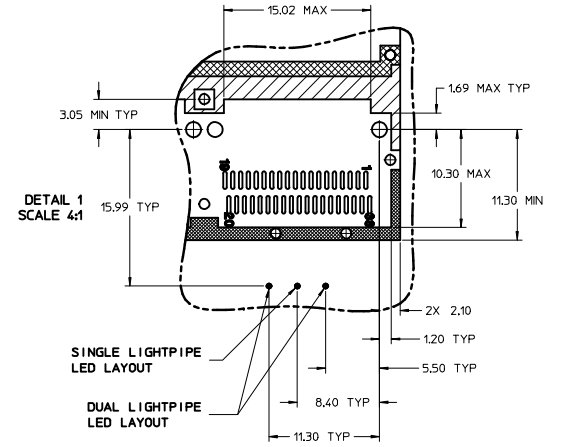

FOR QUAD & 2 ROW QUAD LIGHT PIPE ONLY

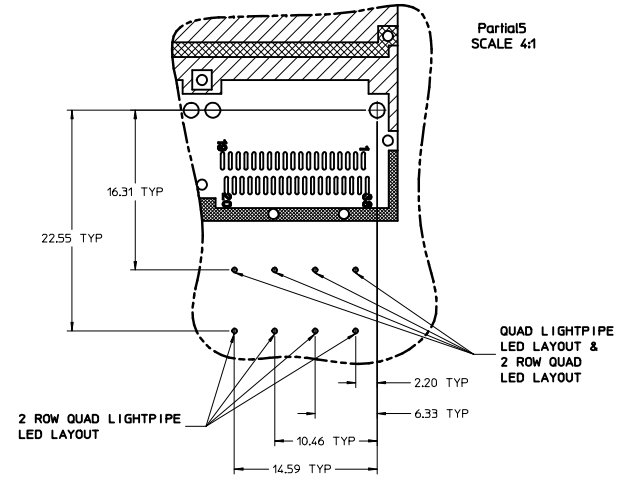

REV HISTORY IEC NO: CPG2015-6002 DRAWN BY: JERWIN 2015/05/18 CHECKED BY: CHYDENE MA 2015/05/18 APPR: K LLOYD 2015/05/18	QUALITY SYMBOLS ∇=0 ∇=0 ∇=0	GENERAL TOLERANCES (UNLESS SPECIFIED)		DIMENSION STYLE MM ONLY	SCALE 4:1	DESIGN UNITS METRIC	THIRD ANGLE PROJECTION	
		4 PLACES ±--- ±--- 3 PLACES ±--- ±--- 2 PLACES ±0.15 ±--- 1 PLACE ±0.25 ±--- 0 PLACE ±--- ±---	mm INCH	DRAWN BY: JERWIN DATE: 2011/05/11	CHECKED BY: CHIRSCHY DATE: 2011/05/11	APPROVED BY:	DATE:	TITLE: QSFP+ 1X3 GANGED CAGE ASSEMBLIES
		ANGULAR ± 1 °		MATERIAL NO: SHT 5, 6 & 7	DOCUMENT NO: SD-74768-0501		SHEET NO: 8 OF 12	
		DRAFT WHERE APPLICABLE MUST REMAIN WITHIN DIMENSIONS						

PCB LAYOUT FOR BELLY TO BELLY MOUNTING

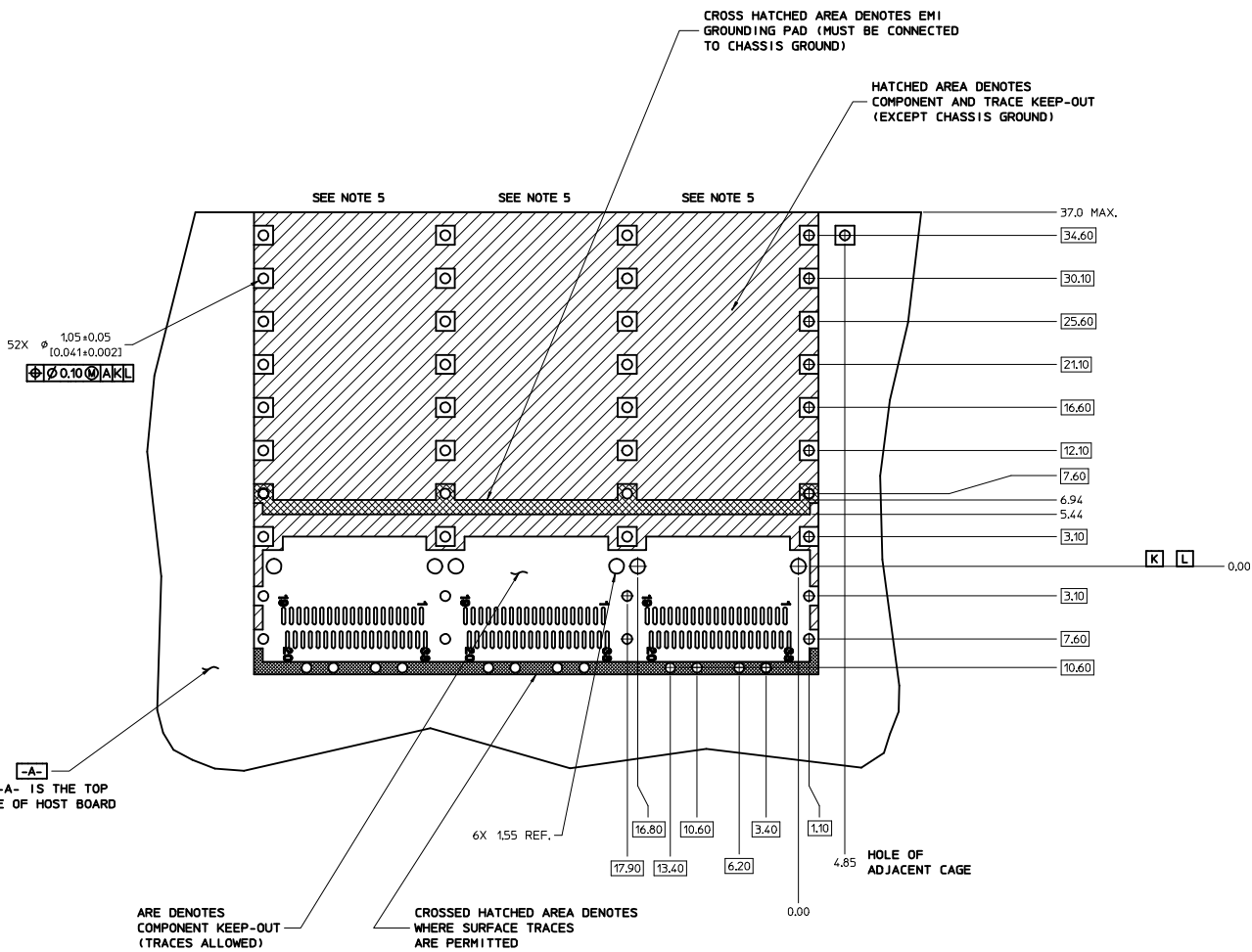

NOTE:
SEE PREVIOUS SHEET FOR
HOST CONNECTOR AND
LED LOCATION DETAILS

NOTES:

1. PADS AND VIAS CONNECT TO CHASSIS GROUND (RECOMMEND PADS TO BE 2.00mm SQUARE)
2. RECOMMENDED THRU HOLE PLATING INCLUDES HASL, OSP, OR IMMERSION (GOLD, SILVER, OR TIN).
3. CONNECTOR PAD LAYOUT PER QSFP MSA WILL ACCOMMODATE MOLEX CONNECTOR 75586-0010 OR 75586-0011.
4. BELLY TO BELLY BOARD THICKNESS:
NONIMAL: 2.90 [0.114"]
MINIMUM: 2.48 [0.098"]
5. SPACING BETWEEN PORTS IS 19.00 [0.748"].

SEE REV HISTORY IEC NO: CPG2015-6002 DRAWN: JERWIN 2015/05/18 CHECKED: NA 2015/05/18 APPR: K LLOYD 2015/05/18 REV DESCRIPTION	QUALITY SYMBOLS ▽=0 ▽=0 ▽=0		GENERAL TOLERANCES (UNLESS SPECIFIED) mm INCH 4 PLACES +--- +--- 3 PLACES +--- +--- 2 PLACES +0.15 +--- 1 PLACE +0.25 +--- 0 PLACE +--- +---		DIMENSION STYLE MM ONLY		SCALE 4:1		DESIGN UNITS METRIC		THIRD ANGLE PROJECTION	
	ANGULAR ± 1 °		DRAFT WHERE APPLICABLE MUST REMAIN WITHIN DIMENSIONS		MATERIAL NO. SHT 5, 6 & 7		DOCUMENT NO. SD-74768-0501		SHEET NO. 9 OF 12		TITLE QSFP+ 1X3 GANGED CAGE ASSEMBLIES	
	THIS DRAWING CONTAINS INFORMATION THAT IS PROPRIETARY TO MOLEX INCORPORATED AND SHOULD NOT BE USED WITHOUT WRITTEN PERMISSION											
	MOLEX											

BOARD AND BEZEL POSITION DIMENSIONS FOR BELLY TO BELLY MOUNTING

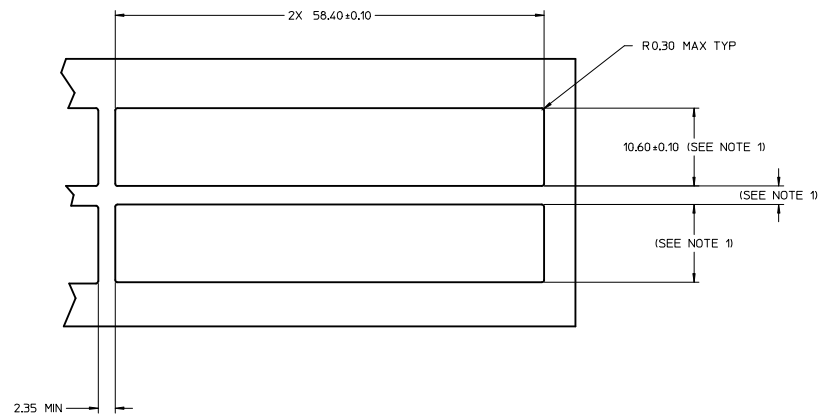
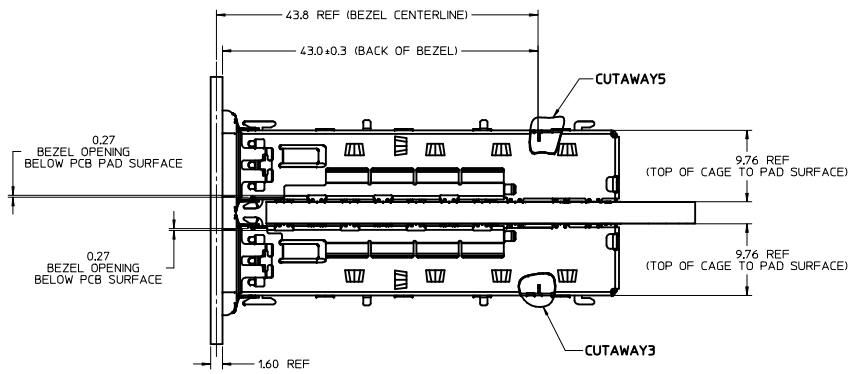

NOTES:
1. PCB THICKNESS VARIATION MUST BE CONSIDERED WHEN DETERMINING BEZEL OPENING, SIZE AND LOCATION.

BOARD AND BEZEL POSITION DIMENSIONS FOR SINGLE SIDE MOUNTING

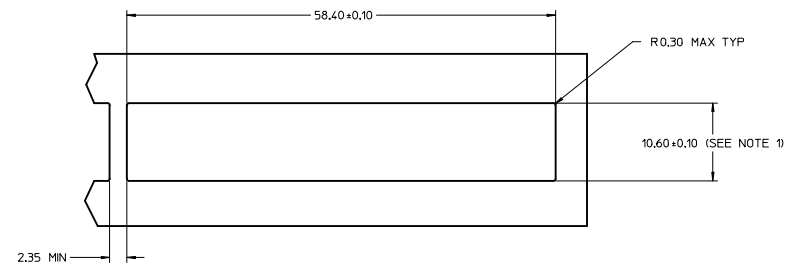
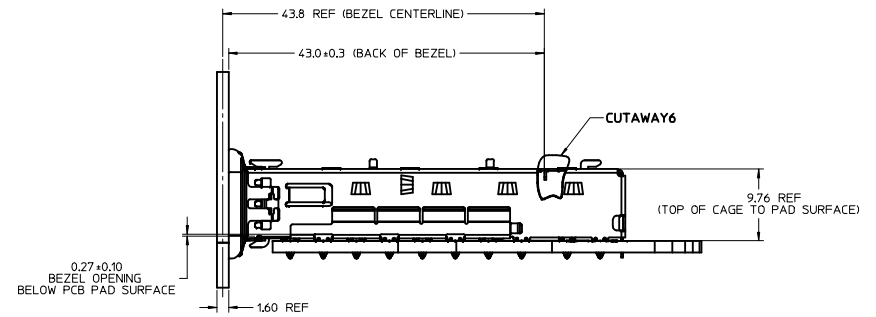

SEE REV HISTORY IEC NO: CPG2015-6002 DRAWN BY: JERWIN 2015/05/18 CHECKED BY: CHRYSOMEDINA 2015/05/18 APPR: K LLOYD 2015/05/18	QUALITY SYMBOLS	GENERAL TOLERANCES (UNLESS SPECIFIED)	DIMENSION STYLE	SCALE	DESIGN UNITS	THIRD ANGLE PROJECTION
	▽=0	mm INCH	MM ONLY	3:1	METRIC	
	▽=0	4 PLACES ± --- ± ---	DRAWN BY: JERWIN DATE: 2011/05/11	TITLE: QSFP+ 1X3 GANGED CAGE ASSEMBLIES		
	▽=0	3 PLACES ± --- ± ---	CHECKED BY: CHIRSCHY DATE: 2011/05/11	APPROVED BY: DATE: _____		
	ANGULAR ± 1°	DRAFT WHERE APPLICABLE MUST REMAIN WITHIN DIMENSIONS	MATERIAL NO. SHT 5, 6 & 7	DOCUMENT NO. SD-74768-0501	SHEET NO. 10 OF 12	
			THIS DRAWING CONTAINS INFORMATION THAT IS PROPRIETARY TO MOLEX INCORPORATED AND SHOULD NOT BE USED WITHOUT WRITTEN PERMISSION			

LIGHT PIPE CUTOUT DIMENSIONS

SINGLE LIGHT PIPE

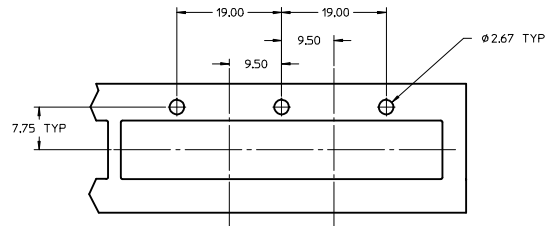

QUAD LIGHT PIPE (SQUARE)

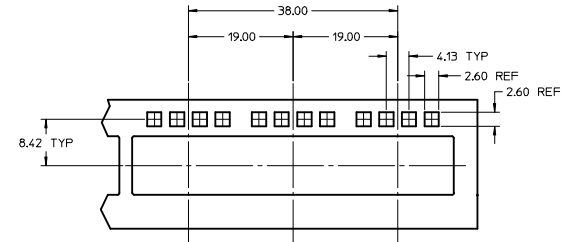

DUAL LIGHT PIPE

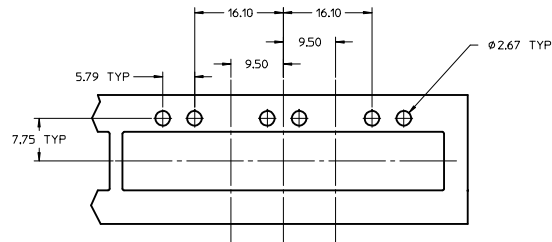

2 ROW QUAD LIGHT PIPE

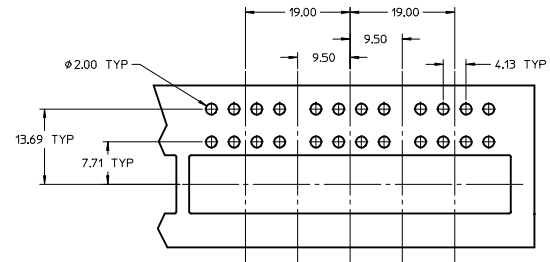

QUAD LIGHT PIPE (ROUND)

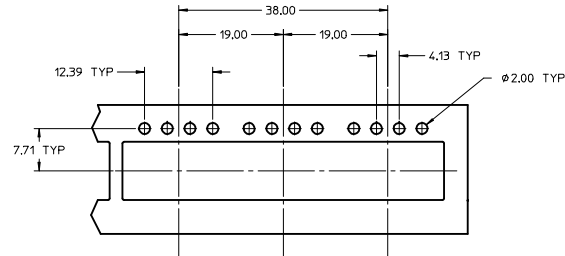

NOTES:
 1. PCB THICKNESS VARIATION MUST BE CONSIDERED WHEN DETERMINING BEZEL OPENING, SIZE AND LOCATION.

SEE REV HISTORY IEC NO: CPG2015-6002 DRAWN: JERWIN 2015/05/18 CHECKED: CHYKORADINA 2015/05/18 APPR: K LLOYD 2015/05/18 REV DESCRIPTION	QUALITY SYMBOLS ∇=0 ∇=0 ∇=0		GENERAL TOLERANCES (UNLESS SPECIFIED) <table border="1"> <thead> <tr> <th></th> <th>mm</th> <th>INCH</th> </tr> </thead> <tbody> <tr> <td>4 PLACES</td> <td>±0.15</td> <td>±---</td> </tr> <tr> <td>3 PLACES</td> <td>±0.25</td> <td>±---</td> </tr> <tr> <td>2 PLACES</td> <td>±0.38</td> <td>±---</td> </tr> <tr> <td>1 PLACE</td> <td>±0.51</td> <td>±---</td> </tr> <tr> <td>0 PLACE</td> <td>±0.64</td> <td>±---</td> </tr> </tbody> </table>			mm	INCH	4 PLACES	±0.15	±---	3 PLACES	±0.25	±---	2 PLACES	±0.38	±---	1 PLACE	±0.51	±---	0 PLACE	±0.64	±---	DIMENSION STYLE MM ONLY	SCALE 2.25:1	DESIGN UNITS METRIC	THIRD ANGLE PROJECTION
		mm	INCH																							
	4 PLACES	±0.15	±---																							
	3 PLACES	±0.25	±---																							
2 PLACES	±0.38	±---																								
1 PLACE	±0.51	±---																								
0 PLACE	±0.64	±---																								
DRAWN BY: JERWIN DATE: 2011/05/11		CHECKED BY: CHIRSCHY DATE: 2011/05/11		APPROVED BY:		TITLE: QSFP+ 1X3 GANGED CAGE ASSEMBLIES																				
MATERIAL NO.: SHT 5, 6 & 7		DOCUMENT NO.: SD-74768-0501		SHEET NO.: 11 OF 12		THIS DRAWING CONTAINS INFORMATION THAT IS PROPRIETARY TO MOLEX INCORPORATED AND SHOULD NOT BE USED WITHOUT WRITTEN PERMISSION																				
DRAFT WHERE APPLICABLE MUST REMAIN WITHIN DIMENSIONS		ANGULAR ± 1°		SIZE D		MOLEX																				

DATE	REV	DESCRIPTION
2009/08/03	A	1) INITIAL RELEASE
2010/11/23	B	1) ADDED PART NUMBERS TO CHART AND FIXED INCORRECT P/N
2011/06/11	C	1) ADDED P/N 747680511 TO SHEET 1, ADDED P/N 747690511 TO SHEET 2
2011/05/11	D	1) REMOVED THE 1X2 AND 1X4 GANGED CAGES
2012/05/24	E	1) FIXED BEZEL OPENING DIM. WAS SHOWING ABOVE PCB SURFACE NOW SHOWING BELOW PCB SURFACE.
2013/11/05	F	1) ADDED PART NUMBER 747680512 TO PART NUMBER CHART SHEET 1.
2013/12/08	G	1) COMBINED SD-74768-0212 TO SD-74768-0501, ADDED HEATSINKS, LIGHT PIPE, PCB AND BEZELS FOR QUAD APPLICATIONS AND REVISED LAYOUT OF ENTIRE DRAWING.
2014/02/11	H	1) SHT1: CORRECTED GASKET DIMENSIONS FOR FRONT VIEW. SHT2: CHANGED NOTE: 1) FOR LIGHT PIPE OPTIONS SEE SHEET 3 TO, 1) FOR LIGHT PIPE OPTIONS SEE SHEET 4. REMOVED DIMENSIONS DIM "B" (SEE SHEET 6) CHANGED DIMENSION 22.55 REF TO, 22.55 +/-0.25 AND 16.31 REF TO, 16.31 +/-0.25. REMOVED TOLERANCE COLUMN FROM HEATSINK HEIGHT OPTIONS CHART AND CHANGED DIM "A" TO, DIM "A" MAX. SHT3: ADDED QUAD LIGHT PIPE (WITH SQUARE TIPS), QUAD LIGHT PIPE (WITH FLARED TIPS) AND 2 ROW LIGHT PIPE (ROUND TIPS). MOVED ALL OTHER VIEWS, LEG OPTIONS AND GASKET OPTIONS AND NOTE: 1 TO SHEET 4. SHT7: REMOVED DIM "B" COLUMN FROM P/N'S 747680529 & 0530 AND ADDED P/N'S 747680429 & 0550. ADDED VIEWS AND PART NUMBERS FOR QUAD ASSEMBLIES WITH SQUARE, FLARED TIP OR 2 ROW QUAD LIGHT PIPES SHT8: CHANGED TEXT LED CENTERLINE TO, LED CENTERLINE (NOT FOR QUAD LIGHT PIPES). ADDED LED LOCATIONS FOR THE 2 ROW QUAD TO VIEW PARTIAL 6. ADDED NEW NOTE 4 AND CHANGED HOLE PATTERN NOTE FROM "HOLE PATTERN REPEATS FOR EACH PORT. SPACING BETWEEN PORTS IS 19.00 [0.748] TO, SPACING BETWEEN PORTS IS 19.00 [0.748]. SHT9: ADDED NEW NOTE 4 AND CHANGED HOLE PATTERN NOTE FROM "HOLE PATTERN REPEATS FOR EACH PORT. SPACING BETWEEN PORTS IS 19.00 [0.748] TO, SPACING BETWEEN PORTS IS 19.00 [0.748]. SHT10: REMOVED NOTE 2. SHT11: REMOVED NOTE 2 AND ALL BELLY TO BELLY BEZELS. ADDED SQUARE AND 2 ROW QUAD BEZELS
2014/07/28	I	SHT3: UPDATED 2 ROW QUAD LIGHT PIPE VIEW. SHT4: UPDATED 2 ROW QUAD TOP VIEW AND ADDED CUTAWAY VIEW. SHT5: ADDED ISO OF CLOSED TOP WITH SINGLE LIGHT PIPE AND ASSOCIATED PART NUMBERS. ADDED P/N'S 747680204, 0205, 0206 & 0207 TO NO HEATSINKS/ NO LIGHT PIPES CHART. SHT7: UPDATED 2 ROW QUAD LIGHT PIPE WITH HEATSINKS VIEW.
2014/09/24	J	SHT2: ADDED VIEW FOR ASSEMBLY W/ SINGLE QUAD LIGHT PIPE. SHT3: ADDED VIEW AND CHART FOR LED CLEARANCE. SHT4: CORRECTED TEXT FROM 2.6 X 41.0 [.0103 X 1.62 INCH] ROUND GASKET TO, 2.6 X 41.0 [.0103 X 1.62 INCH] ROUND GASKET. ADDED VIEWS FOR ASSEMBLIES USING ROUND TIP QUAD LIGHT PIPE AND SQUARE/ FLARED TIP LIGHT PIPES. SHT7: ADDED DIM "B" & "C" COLUMNS TO CHART FOR 2 ROW QUAD LIGHT PIPE WITH HEAT SINKS ASSEMBLIES.
2015/05/17	K	SHT5: REMOVED P/N 747680508 FROM DRAWING AND MOVED P/N 747680509 TO SHEET 6.

SEE REV HISTORY IEC NO: CPG2015-6002 DRAWN: JERWIN 2015/05/18 CHECKED: CHYKEDINA 2015/05/18 APPR: K LLOYD 2015/05/18	QUALITY SYMBOLS ∇=0 ∇=0 ∇=0	GENERAL TOLERANCES (UNLESS SPECIFIED)		DIMENSION STYLE MM ONLY	SCALE 5:1	DESIGN UNITS METRIC	THIRD ANGLE PROJECTION
		4 PLACES ± mm INCH 3 PLACES ± --- ± --- 2 PLACES ± 0.15 ± --- 1 PLACE ± 0.25 ± --- 0 PLACE ± --- ± ---	DRAWN BY: JERWIN DATE: 2011/05/11	TITLE QSFP+ 1X3 GANGED CAGE ASSEMBLIES			
		ANGULAR ± 1 ° DRAFT WHERE APPLICABLE MUST REMAIN WITHIN DIMENSIONS	CHECKED BY: CHIRSCHY DATE: 2011/05/11	APPROVED BY			
		MATERIAL NO. SHT 5, 6 & 7 DOCUMENT NO. SD-74768-0501 SHEET NO. 12 OF 12					

THIS DRAWING CONTAINS INFORMATION THAT IS PROPRIETARY TO MOLEX INCORPORATED AND SHOULD NOT BE USED WITHOUT WRITTEN PERMISSION