



AB-GES-P28212WxxBFT2

Features:

- 12W 1ft Linear AC LED light engine
- Plug and play with 5VA material lens
- SimpleDrive® - 230V AC drive technology
- Driver on Board structure
- Dimmable^[5] light engine
- Long life - No Electrolytic capacitors
- Easily integrated
- CE Compliance

Applications:

- Under Cabinet Lights
- Ceiling Lights
- In Ground Light
- Wall Sconces
- Vandal Proof Lights
- Cove Light
- Troffer Light



Figure: AC Module

Outline Dimensions

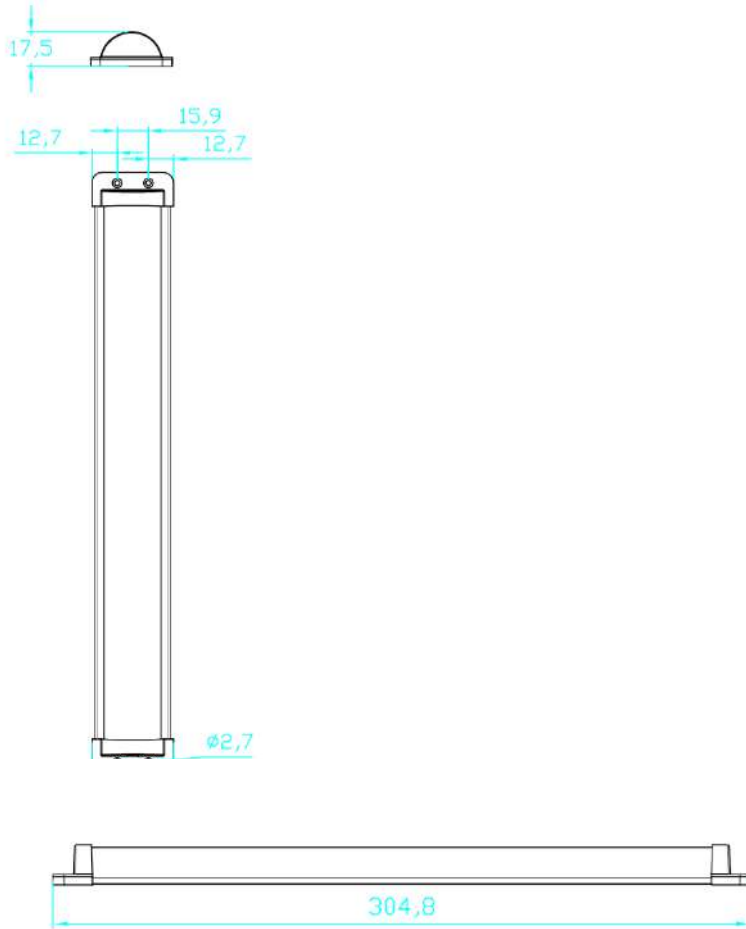

25 LEDs

Units: mm

Notes:

1. Two wires coming out of the housing to connect via wire nut or connector.
2. Thickness of PCB is 1.2mm
3. Tolerance of dimension is +/- 0.15mm
4. IMPORTANT: In order to pass UL1598, add an insulating thermal pad with at least 1.0mm thickness to the module.
5. Please use plastic screw for passing the safety regulation
6. Black and white wire, 10" 18AWG



Characteristics

	Symbol	Rating	Unit
Input Voltage	V _{in}	230	Vac
LED Junction Temperature	T _J	115	°C
Storage Temperature	T _{stg}	-40 ~ 100 °C	°C
Operation Temperature	T _{opr}	-40 ~ 85 °C	°C

■ Absolute Maximum Ratings

- Proper current rating must be observed to maintain junction temperature below maximum at all time. For this product, we suggest to keep the Temperature of TC point under 75°C, and the temperature of Top IC surface under 115°C. After passing the maximum temperature of IC, the rating current will be lower automatically for protecting the whole circuit.

■ Electrical Characteristics, Ta=25°C

Parameter	Symbol	Min.	Max.	Unit
Input Voltage	V _{in}	210	250	Vac
Input Frequency	Freq.	50/60		Hz
Power Factor	PF	0.9	0.95	-
Flicker % ^[1]		100%		
Flicker Index ^[1]		0.3		

- Surge protection is up to 0.5KV

■ Optical Characteristics (V_{in}=120V), Ta=25°C

Model name	AC Power			Color Temp (K)	Luminous Flux(lm)		CRI
	Min	Typ.	Max		Min	Typ	
AB-GES-P28212W30BFT2	10.5	12.0	13.5	3000	870	1000	>80
AB-GES-P28212W35BFT2	10.5	12.0	13.5	3500	900	1030	>80
AB-GES-P28212W40BFT2	10.5	12.0	13.5	4000	938	1080	>80
AB-GES-P28212W50BFT2	10.5	12.0	13.5	5000	938	1080	>80

- Correlated color Temperature is derived from the CIE 1931Chromaticity diagram.
- The luminous flux tolerance is ± 10%.
- This CRI value tolerance is ± 2.
- Calibration accuracy of CIEx and CIEy : ±0.007 ;
- Calibration error CCT 3000K ±175K ; 4000K ±300K ; 6500K ±400K

■ Thermal Resistance, Ta=25°C

Part	Min.	Typ.	Max.	Unit
LED		12		°C/W
IC	15		20	°C/W

■ **Relative Spectrum of Emission (Ta=25°C, Test current=60mA)**

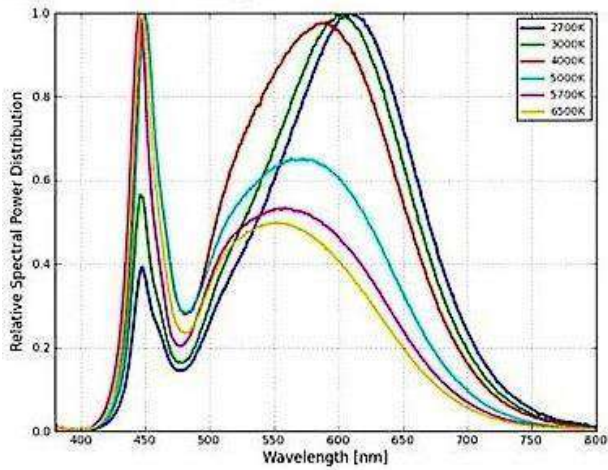

■ **Radiation Pattern (Tj=25 °C)**

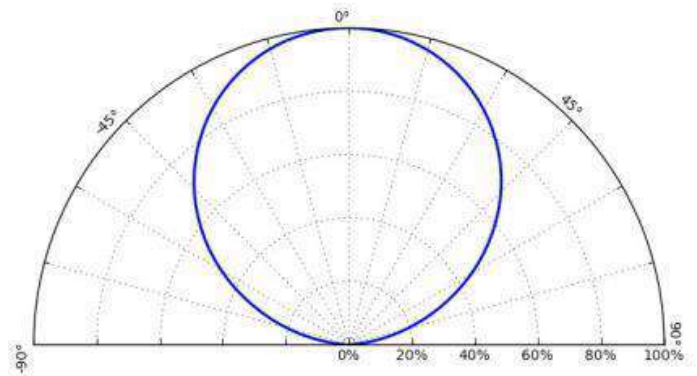

■ **Relative power distribution vs. Input voltage (Ta=25°C)**

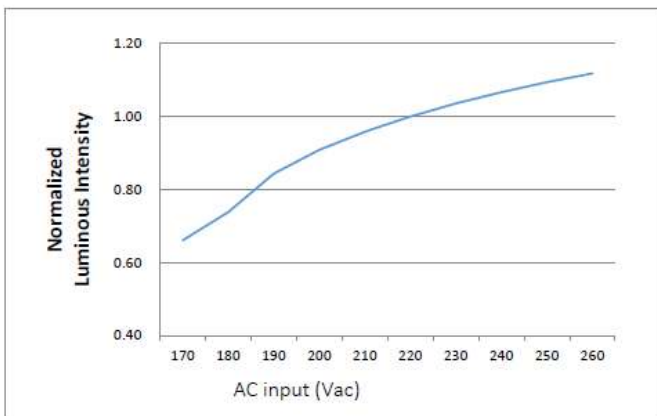

■ **Relative luminous output vs. Input voltage (Ta=25°C)**

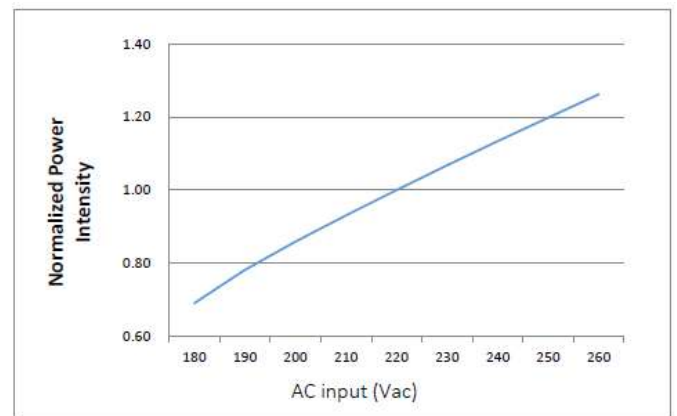

■ **Conduction Testing^[5] (220Vac/60Hz)**

Standard: EN 55015 (QP), Temp. (C)/Hum.(%): 25°C/57%

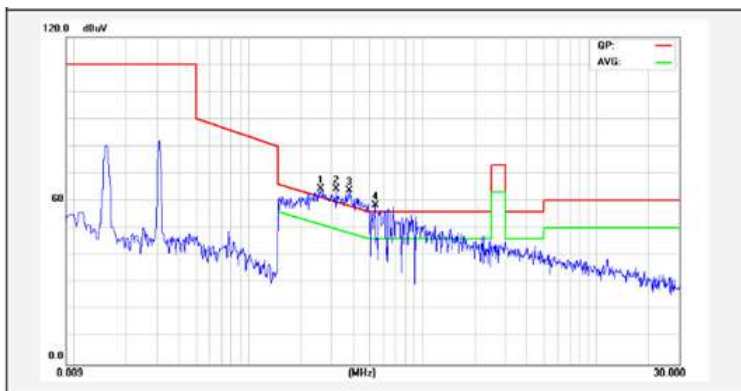

■ **Conduction Testing^[5] 2 (220Vac/60Hz)**

Standard: EN 55015 (QP), Temp. (C)/Hum.(%): 25°C/57%

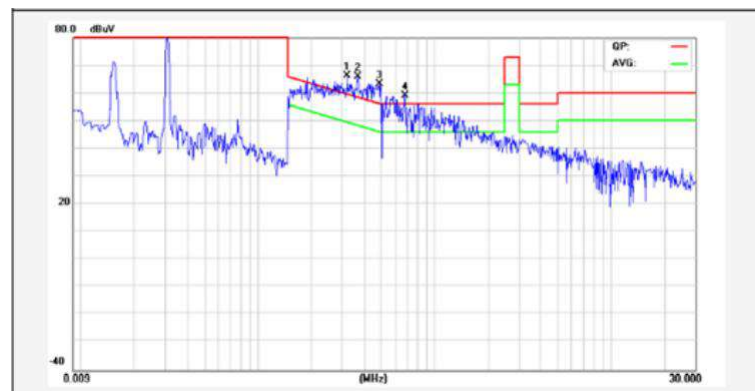

Packaging

1. ESD bubble bag

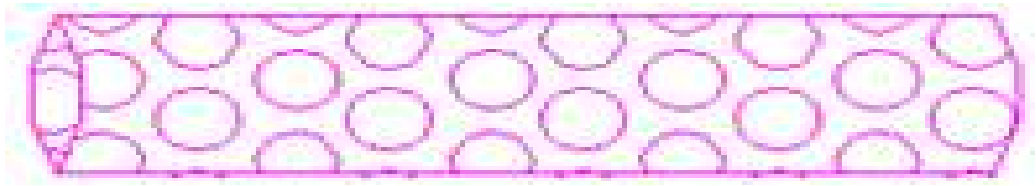

1 items per bag

Color Bin Code

Color region stays within Macadam "3-Step" ellipse from the chromaticity center.
 The chromaticity center refers to ANSI C78.377:2008.

Please refer to ANSI C78.377 for the chromaticity center.

CC	Steps	C	C	a	b	theta
2700K	3	0.4578	0.4101	0.00810	0.00420	53.7
3000K	3	0.4338	0.4030	0.00834	0.00408	53.2
3500K	3	0.4073	0.3917	0.00927	0.00414	54.0
4000K	3	0.3818	0.3797	0.00939	0.00402	53.7
5000K	3	0.3447	0.3553	0.00822	0.00354	59.6
5700K	3	0.3287	0.3417	0.00746	0.00320	59.0
6500K	3	0.3123	0.3282	0.00669	0.00285	58.5

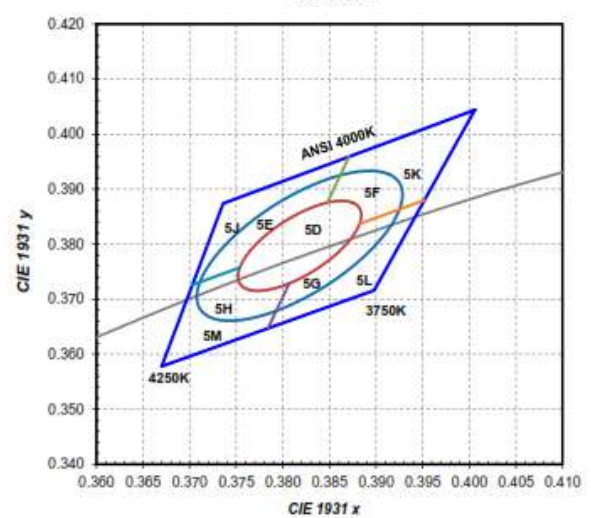
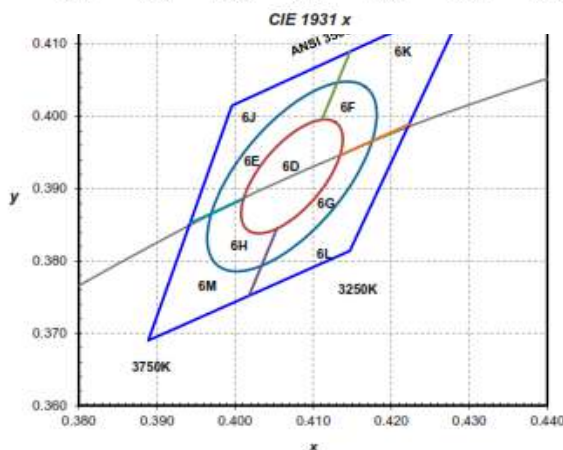
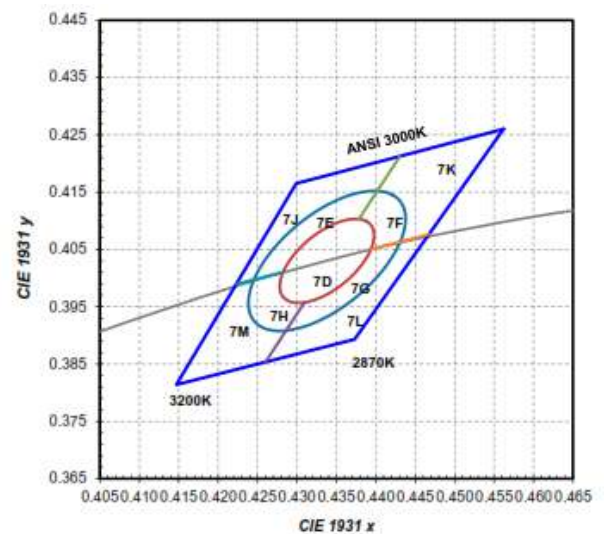
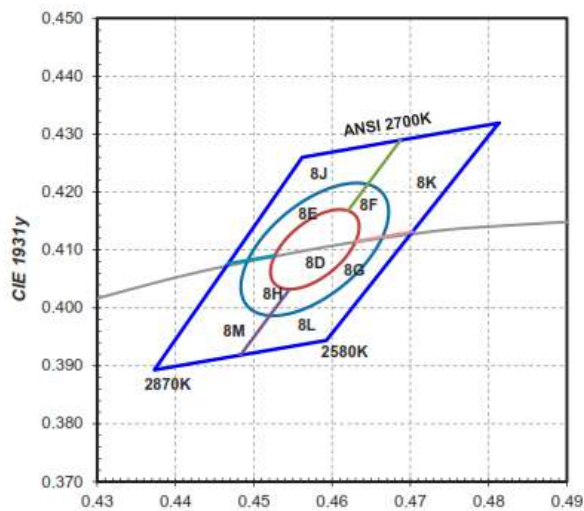

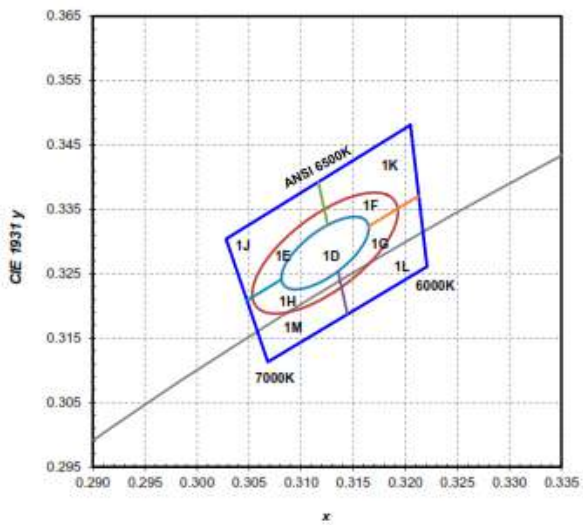
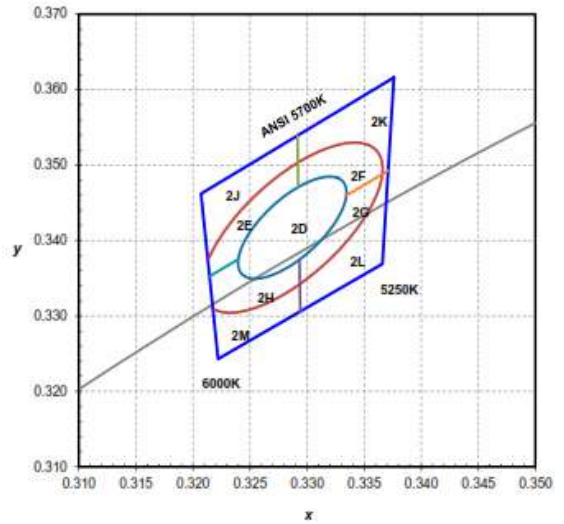
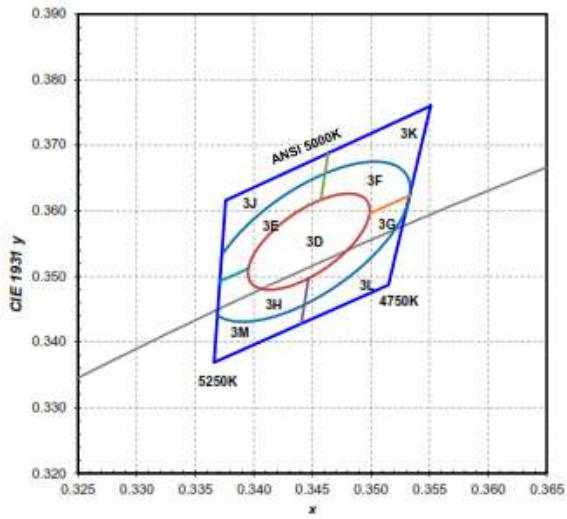

AC Module Flicker

Flicker for AC driven LED modules can be measured in two different manners, Percent and Index.

Percent - Older more common metric that measures peak to peak amplitude. No other attributes of the AC wave are taken into account. Measurements of percent range from 0%-100%

AC Module Flicker	100%
Any LED system with Electrolytic Capacitor	2%-90%

Index - A metric defined by the IES (Illuminating Engineering Society) that measures the shape, duty cycle, and peak to peak amplitude. This is a true measure of eye response to flicker. Measurement of index range from 1-1.0.

AC Module Index	<0.3
Any LED system with Electrolytic Capacitor	.02~0.2

Graph showing measurement differences

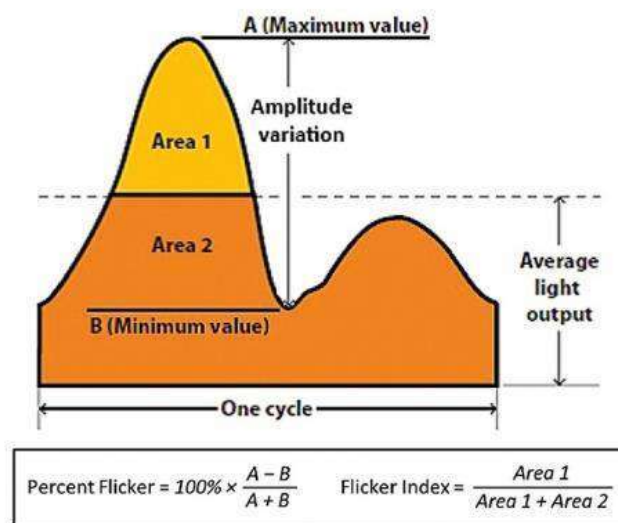

Junction Temperature (T_j) & Solder Point Temperature (T_s)

Junction Temperature is the most important factor of LED. Different life performance will be impacted by different junction temperature.

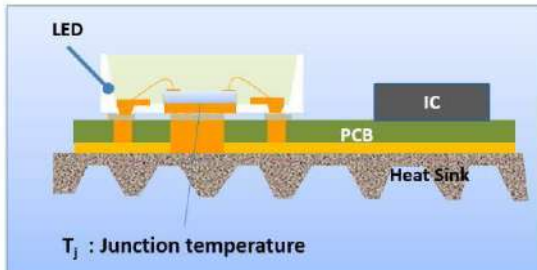

If the thermal dissipation is good enough, the junction temperature will be lower and the lifetime performance will be better.

If the junction temperature is higher than 120°C, the LED will deteriorate quickly.

How to monitor the junction temperature?

You need to measure the T_s point.

A solder point temperature is a temperature at the measurable point nearest to the junction. Typically this point is at the solder joint.

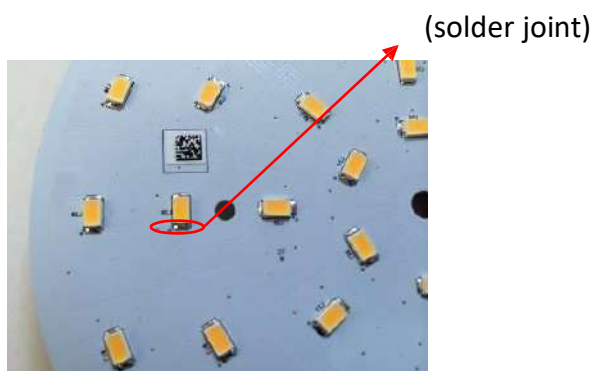

You can use the high-temperature thermal conductivity glue (Such as SatlonD-3/606...etc.) to fix the thermal couple to the solder joint then measure the temperature. Once you got the T_s temperature measurement data, you can calculate the junction temperature based on the measurement data of the T_s . The details of the calculation method are shown in the following page:

Calculate the Junction temperature of LED

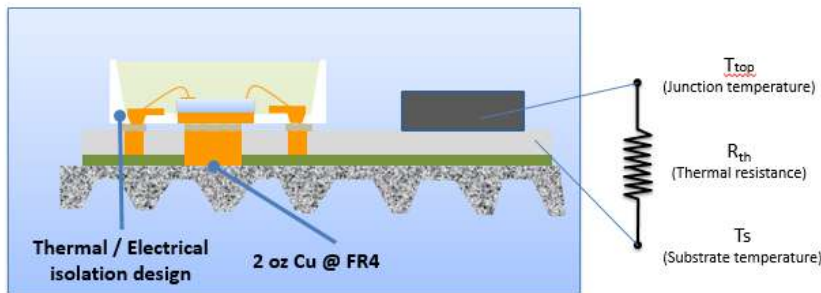

$$T_{j,LED} = T_s + R_{th} * P_D$$

The junction temperature should be calculated by the Substrate temperature (T_s) and the thermal resistance of Substrate (R_{th}).

Examples:

What is the T_j of LED (R_{th}= 12 °C/W) at 40°C?

T_s=40°C, LED P_D=0.5W, LED R_{th}= 12 °C/W (typical)

★T_{j,LED}= 40 + 0.5*12 = 45.5°C (Normal T_{j,LED} limitation is 110°C)

Calculate the Junction temperature of IC

$$T_{j,IC} = T_s + R_{th,IC} * P_D$$

The junction temperature should be calculated by the Substrate temperature (T_s) and the Thermal resistance of Substrate (R_{th})

IC	IC power consumption	R _{th,ic}
	AC input	
	100V-220V	15

Thermal resistance of IC under different AC input

Examples:

What is the T_j of IC (R_{th}= 15 °C/W) at 40°C?

T_s=40°C, IC P_D=1.68W, IC R_{th}= 15 °C/W (minimum)

★T_{j,IC}= 40 + 1.68*15 = 65.2°C (Normal T_{j,IC} limitation is 110°C)

Backside of AC LED module

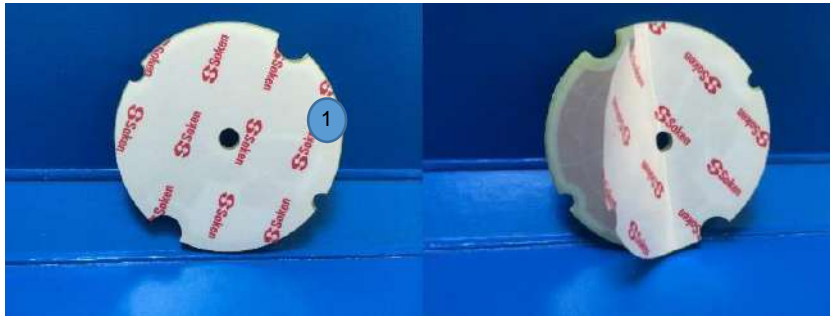

Picture of the backside of module

Items:

Warning:

Remember to remove the protective paper on the thermal insulating tape from the backside of the module

Warning:

AC LED modules must be attached by an additional connection, not only the tape

Specification of the Thermal tape

Thickness	mm	0.25
Adhesive force	T ₀ (0 hrs)	4.0
	T ₂₄ (24 hrs)	4.6
Thermal conductivity	W / m •K	0.7
Thermal resistance	cm ² °C/W	3.6
Fire ret ardency	UL94	V0
Isolation strength	DC (kV)	>10
	AC (kV)	4.4



Reference Information

- [1] Flicker information, please refer to page 8.
- [2] Junction Temperature (T_j) & T_s Point information please refer to page 9.
- [3] Thermal tape information, please refer to page 11.
- [4] Dimmer list, please refer to page 13.
- [5] The primary goal of **EMC testing** is to identify the sources of electromagnetic energy emitted from an electronic device in an effort to reduce potential interference to other equipment, as well as determine the susceptibility of the equipment from electromagnetic energy emitted from other electronic devices nearby.