



HS3A thru HS3M

High Efficient Surface Mount Rectifiers
Reverse Voltage 50 to 1000 Volts Forward Current 3.0 Amperes

Features

- ◆ Glass passivated junction chip.
- ◆ For surface mounted application
- ◆ Low forward voltage drop
- ◆ Low profile package
- ◆ Built-in stain relief, ideal for automatic placement
- ◆ Fast switching for high efficiency
- ◆ High temperature soldering:
250°C/10 seconds at terminals
- ◆ Plastic material used carries Underwriters Laboratory
Classification 94V-O



DO-214AB (SMC)

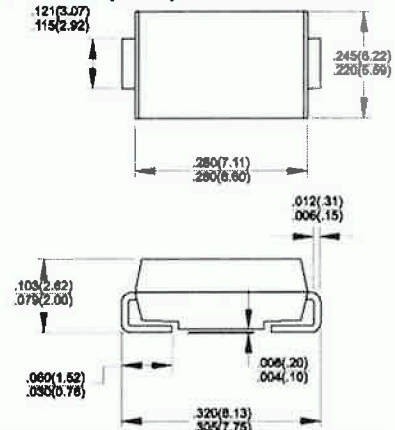

Dimensions in inches and (millimeters)

Mechanical Data

- ◆ Cases: Molded plastic
- ◆ Terminals: Solder plated
- ◆ Polarity: Indicated by cathode band
- ◆ Weight: 0.009 ounce, 0.21 gram

Maximum Ratings and Electrical Characteristics

Ratings at 25°C ambient temperature unless otherwise specified.
Single phase, half wave, 60Hz, resistive or inductive load
For capacitive load, derate current by 20%

Parameter	Symbols	HS3A	HS3B	HS3D	HS3F	HS3G	HS3J	HS3K	HS3M	Units	
Maximum repetitive peak reverse voltage	V_{RSM}	50	100	200	300	400	600	800	1000	Volts	
Maximum RMS voltage	V_{RMS}	35	70	140	210	280	420	560	700	Volts	
Maximum DC blocking voltage	V_{DC}	50	100	200	300	400	600	800	1000	Volts	
Maximum average forward rectified current See Fig 2	I_{AV}	3.0								Amps	
Peak forward surge current, 8.3ms single half sine-wave superimposed on rated load (JEDEC Method)	I_{FSM}	150.0								Amps	
Maximum instantaneous forward voltage @ 3.0A	V_F	1.0			1.3		1.7			Volts	
Maximum DC reverse current @ $T_A=25^\circ\text{C}$ at rated DC blocking voltage @ $T_A=100^\circ\text{C}$	I_R	10.0				200					uA uA
Maximum reverse recovery time (Note 1)	t_{rr}	50				75				nS	
Typical junction capacitance (Note 2)	C_j	80				50					pF
Operating junction temperature range	T_J	-55 to +150									°C
Storage temperature range	T_{STG}	-55 to +150									°C

Notes: 1. Reverse Recovery Test Conditions: $I_F=0.5A$, $I_R=1.0A$, $I_{RR}=0.25A$
2. Measured at 1 MHz and Applied Reverse Voltage of 4.0 V D.C.



RATINGS AND CHARACTERISTIC CURVES

FIG 1- REVERSE RECOVERY TIME CHARACTERISTIC AND TEST CIRCUIT DIAGRAM

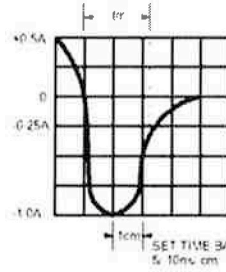
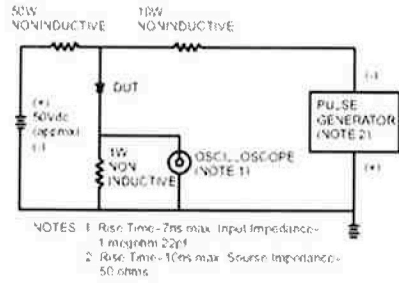

FIG 2- MAXIMUM FORWARD CURRENT DERATING CURVE

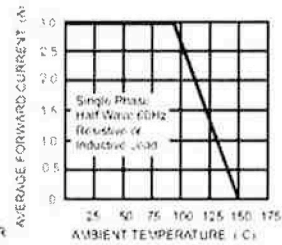

FIG-3- TYPICAL REVERSE CHARACTERISTICS

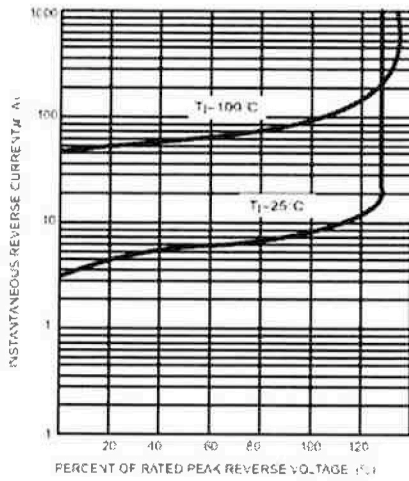

FIG 4- TYPICAL INSTANTANEOUS FORWARD CHARACTERISTICS

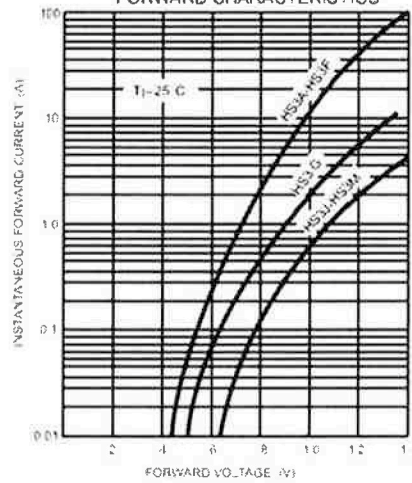

FIG 5- MAXIMUM NON-REPETITIVE FORWARD SURGE CURRENT

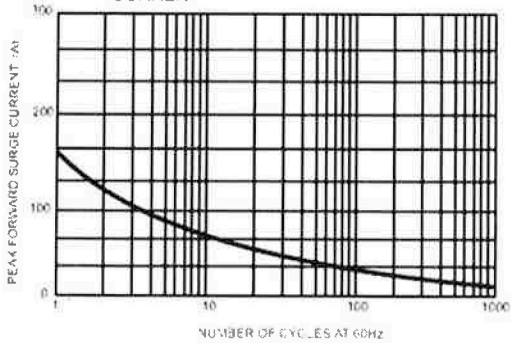

FIG-6- TYPICAL JUNCTION CAPACITANCE

