

Design Note

DN-EVALSF2-ICE2B765P-1

CoolSET™
80W 24V Design Note for Adapter using ICE2B765P

Author: Rainer Kling

Published by Infineon Technologies AG

<http://www.infineon.com/CoolSET>

Power Management & Supply



Never stop thinking

Table of Contents

TABLE OF CONTENTS	1
INTRODUCTION	2
<i>Application</i>	2
<i>CoolSET™</i>	2
LIST OF FEATURES	3
POWER SUPPLY SPECIFICATION	3
SCHEMATIC	4
PCB LAYOUT	5
DESCRIPTION	6
<i>Introduction</i>	6
<i>Line Input</i>	6
<i>Startup</i>	6
<i>Operation Mode</i>	6
<i>Softstart</i>	6
<i>Snubber Network</i>	6
<i>Limitation of primary current</i>	6
<i>Output Voltage</i>	7
<i>Regulation</i>	7
<i>EMI Behavior</i>	7
BILL OF MATERIAL	8
TRANSFORMER CONSTRUCTION DOCUMENTATION	9
PERFORMANCE DATA	12
<i>Efficiency</i>	12
<i>No-Load Input Power (Standby)</i>	13
<i>Regulation and Power Limiting</i>	13
<i>Startup Curves (Low Line)</i>	15
<i>Startup Curves (High Line)</i>	16
<i>Loadjump</i>	17
<i>AC Output Voltage Ripple</i>	18
<i>Drain Source Voltage and Current</i>	19
REFERENCES	21

Introduction

Application

This document is an engineering report that describes a universal input power supply designed in a typical off line flyback converter topology that utilizes the **ICE2B765P CoolSET™**. The application operates in discontinuous current mode using the frequency reduction during standby condition¹. The board has one output voltage with secondary regulation.

This board demonstrates the basic performance features and the power capability of the latest CoolSET™ device ICE2B765P of the second generation of CoolSET™ in a TO220 package with extended creepage distance for higher electrical strength and isolated tab.

CoolSET™

CoolSET™ is a current mode control IC and the power MOSFET CoolMOS™ within one standard package designed for low cost power supplies. CoolSET™ combines the superior technology of CoolMOS™ and the optimized technology of the control IC with enhanced protection features and improved standby power concept. The integrated propagation delay compensation (patented by Infineon Technologies) prevents a current overshoot, the result is a reduced electrical stress on the MOSFET, the transformer and the output diode. The 650V / 800V high avalanche rugged CoolMOS™ eliminates or reduces the need for a heatsink and permits a SMPS design with a simple RCD snubber and a low cost standard transformer design. The lowest area specific $R_{ds(on)}$ leads to a high efficiency and permits an operation at high ambient temperature. CoolSET™ permits always a safety operation during any error cases due to the integrated protection features.



Figure 1– EVALSF2-ICE2B765P

This document contains the power supply specification, schematic, bill of material and the transformer construction documentation. Typical operating characteristics are presented at the rear of the report and consist of performance curves and scope waveforms.

Note:

Design calculations for the components and the transformer were performed in accordance with the application note “**AN-SMPS-ICE2AXXX for OFF – Line Switch Mode Power Supplies**” and **FlyCal**, a EXCEL based design software according to the application note AN-SMPS-ICE2AXXX. The application note and FlyCal are available on the Internet: www.infineon.com/CoolSET

¹ $P_{OUT} = 0W$

List of Features

Feature
CoolSET™ Device ICE2B765P
External Sense
Adjustable Soft Start
Modulated Gatedrive
Over Load Protection with auto restart
Over Current Protection with auto restart
Over Temperature Shut Down with auto restart
Open Loop Protection with auto restart
Under Voltage Lock Out with auto restart
Drain Source Voltage 650V ²
Frequency Reduction
Internal Leading Edge Blanking
67 kHz operating frequency
TO220 ISODRAIN Package with isolated Tab
Standby Power according to European Commission

Table 1 – List of Features

Power Supply Specification

Description	Symbol	Min	Typ	Max	Units
Input Section					
Input Voltage	V _{ACIN}	85	115/230	270	V _{AC}
Line Regulation (85...270V)			< 1		%
Input Frequency	f	47	50/60	64	Hz
No Load Input Power (230V _{AC})			< 0.9		W
Output Section					
Output Voltage	V _{OUT}	23.5	24	24.5	V _{DC}
AC Output Voltage Ripple (270V _{AC})	V _{Ripple}		<0.1		V _{P-P}
Output Current	I _{OUT}	3.25	3.3	3.35	A _{DC}
Output Power	P _{OUT}	0	80	85	W
Peak Power	P _{OUTmax}		95		W
Standby Power			< 1.0		W
Total Regulation			±2		%
Load Regulation (10...100%)			< 1		%
Efficiency (85V _{AC}) @ nominal Load	η		85		%
Efficiency (270V _{AC}) @ nominal Load	η		90		%
Environmental					
Conducted EMI					EN55022B
Ambient Temperature	T _A	0	50	75	°C
Thermal Consideration @ V_{ACIN} = 85V and Dmax = 69% (ΔT @ Ta = 25°C)					
Transformer			40		°C
CoolSET			60		°C
Output Diode			60		°C
Output Capacitors			35		°C

Table 2 – Power Supply Specification

² V_{DSBR} at T_j = 110°C

Schematic

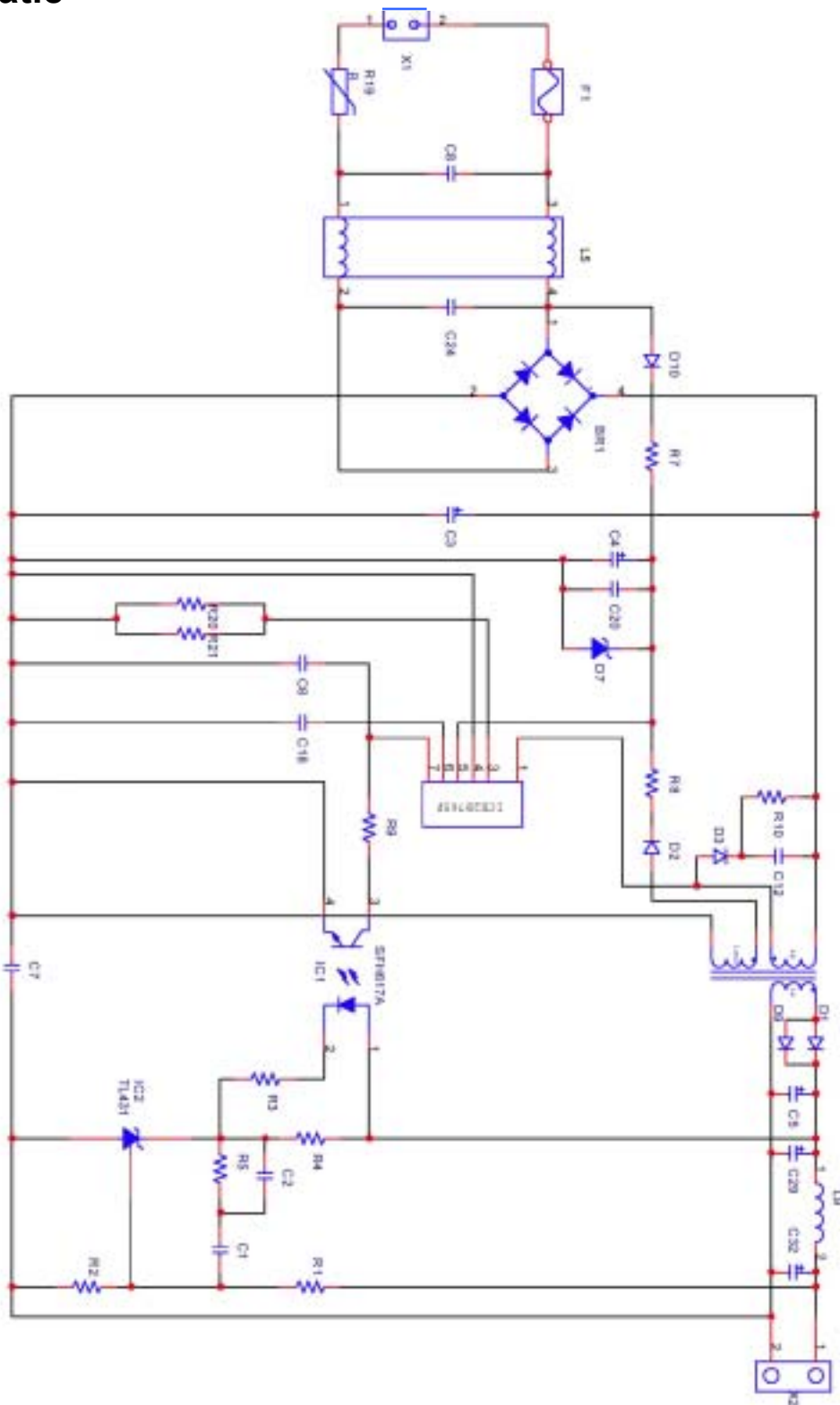

Figure 2 Power Supply Schematic

Description

Introduction

The **EVALSF2-ICE2B765P** demoboard is a low cost flyback switching power supply using the ICE2B765P integrated circuit from the *CoolSET™-F2* family. The circuit shown in Figure 2 details a 24V, 80W supply that operates from an line input voltage range of 85 to 265V_{AC}, suitable for applications requiring either an open frame supply or an enclosed adapter.

Line Input

The AC line input side comprises of an input fuse F1 as line input over current protection as well as choke L5 and the X2 capacitors C8 and C24 as radio interference suppressors. R19 prevents the application against line shut on spikes. After the bridge rectifier BR1 and input capacitor C3, a voltage from 120 to 380 V_{DC} is present. Only a 220µF input capacitor is required due to the wider duty cycle DC_{MAX} of the ICE-F2-family.

Startup

From the line input voltage, the current supply which is used to charge up the chip supply capacitor C4 is derived by using resistors R7 and rectifier diode D10. Because of the very low start up current of typically 27µA, a high-value resistor can be used to realize the startup.

Note:

Improve your standby power via increasing R7.

Operation Mode

During operation, the V_{CC} pin is supplied via a separate transformer winding with associated rectification D2 and buffering C4 and filter capacitor C20. Resistor R8 is used for current limiting during the charging of C4. In order not to exceed the maximum voltage at the V_{CC} pin an external zener diode D7 limits this voltage. During light or no load condition the switching frequency is reduced down to 21kHz in order to reduce the switching losses without audible noise.

Note:

In order to improve the standby power, set the board in the burst mode during no load condition via increasing the chip supply resistor R8.

Softstart

In order to minimize the electrical stress, a Soft-Start function is realized by an internal resistor and the adjustable external capacitor C18.

Snubber Network

Due to the high avalanche rugged CoolMOS™ inside, a simple RCD snubber protection can be used. The network R10, C12 and D3 clamp the DRAIN voltage spike caused by transformer leakage inductance to a safe value below the drain source break down voltage V_{DSBR} = 650V maximum.

Limitation of primary current

The CoolMOS™ drain source current is sensed via external shunt resistors R20 and R21. An accurate value of the shunt improves the peak power limitation shown in the curve peak power limitation in the rear of this report and minimize the electrical stress on the MOSFET, the Transformer and the output rectifier.

Output Voltage

Power is coupled out on the secondary side via a fast-acting diodes D1 and D9 with low forward voltage. Capacitors C5 and C29 performs energy buffering, a following LC - filter C32 and inductor L9 considerably reduces the output voltage ripple. Storage output capacitors C5 and C29 is designed to exhibit a very low ESR in order to minimize the output voltage ripple caused by the triangular current characteristic. The output voltage is set with resistors R1 and R2.

Regulation

The output voltage is controlled using a type TL431 reference diode. This device incorporates the voltage reference as well as the error amplifier and a driver stage. Compensation network C1, C2, R1, R5 constitutes the external circuitry of the error amplifier of IC2. This circuitry allows the feedback to be precisely matched to dynamically varying load conditions, thereby providing stable control. The maximum current through the optocoupler diode and the voltage reference is set by using resistors R3, R4. Optocoupler IC1 is used for floating transmission of the control signal to the "Feedback" input via resistor R9 and capacitor C6 of the ICE2B765P control device. The optocoupler used meets DIN VDE 884 requirements for a wider creepage distance.

EMI Behavior

In order to reduce the conducted EMI behavior, capacitor C7 is set in parallel to the transformer TR1.

Note:

The value should not exceeds 2.2nF in order to guarantee a safety off line switch mode power supply design.

Bill of Material

ICE2B765P Evaluation Board 24V/ 80W

Pos.	Part	Type	Number	Values	Note	Ordering Code
1	BR1	B380 C5000	1			
2	C1 [nF]	470	1	50V		
3	C2 [nF]	0.15	1	50V		
4	C3 [μF]	220	1	385V		
5	C4 [μF]	22	1	25V		
6	C5 [μF]	1000	1	35V	Low ESR	
7	C6 [nF]	2.2	1	50V	X7R	
8	C7 [nF]	2.2	1	275V	Y1 Cap	
9	C8 [μF]	0.22	1	275V	X2 Cap	
10	C12 [nF]	4.7	1	400V	MKT	
11	C18 [nF]	330	1	50V	X7R	
12	C20 [nF]	100	1	50V	X7R	
13	C24 [μF]	0.22	1	275V	X2 Cap	
14	C29 [μF]	1000	1	35V	Low ESR	
15	C32 [μF]	330	1	35V	Low ESR	
16	D1	MUR1520	1	200V		
17	D2	1N4148	1			
18	D3	1N4937	1	200V		
19	D7	ZPD18	1	18V		
20	D9	MUR1520	1	200V		
21	D10	1N4007	1			
22	F1	Microfuse	1	3.15A		
23	F1	Clip for Fuse	2			
24	IC1	SFH617A-3X016	1			
25	IC2	TL431CLP	1			
26	IC3	ICE2B765P	1			
27	L9 [μH]	1.0	1	6A		
28	L5 [μH]	2*27mH	1	1.7A		
29	R1 [kΩ]	40.0	1	0.6W	1%	
30	R2 [kΩ]	4.7	1	0.6W	1%	
31	R3 [kΩ]	1.1	1	0.6W		
32	R4 [kΩ]	1.6	1	0.6W		
33	R5 [kΩ]	180.0	1	0.6W		
34	R7 [kΩ]	680	1	0.6W		
35	R8 [Ω]	7.5	1	0.6W		
36	R9 [Ω]	22.0	1	0.6W		
37	R10 [kΩ]	10.0	1	2W		
38	R19	NTC10	1			
39	R20 [Ω]	0.43	1	0.6W	1%	
40	R21 [Ω]	0.39	1	0.6W	1%	
41	TR1	ETD39/18/13	1	1mm	Gap	
42	Heatsink		1	11 kW		For ICE2B756P
43	Heatsink		2	18 kW		For Output Rectifiers
44	X1, X2	Connector 2pol.	2			

Transformer Construction Documentation

Al-Value: 190 nH
 Gap: 1 mm
 Margin: 0 mm
 Inductance: 1,49E-04 H
 Leakage Ind.: 7,7E-06 H (5%)

THOMSON MULTI MEDIA	SMT31	40335-xx
	SPF : G7183-00	A

OUTPUT CHARACTERISTICS

Pin	Value	Leads	Remarks
16/15/14/13 - 12/11/10/9	24 V	1,3A	
6 - 8	11.5 V	/	VCC
3 - 1		1c	Primary

CIRCUIT DIAGRAM

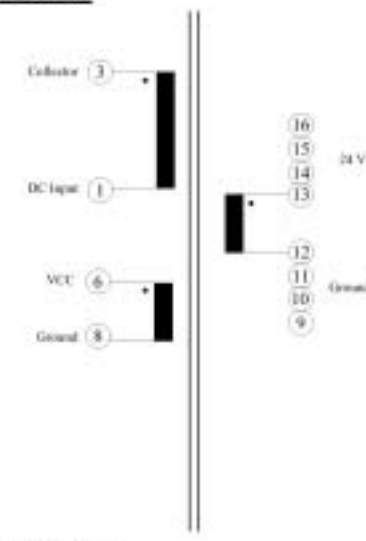

PRIMARY SIDE

OREGA	PRODUCT SPECIFICATIONS <small>Rev D Dpt : Tel : (33)01 54 64 34 08 - Fax (33)01 54 64 34 28</small>	Page : 3
--------------	---	----------

Reproduction is not permitted without THOMSON TELEVISIONS COMPOSANTS FRANCE explicit consent

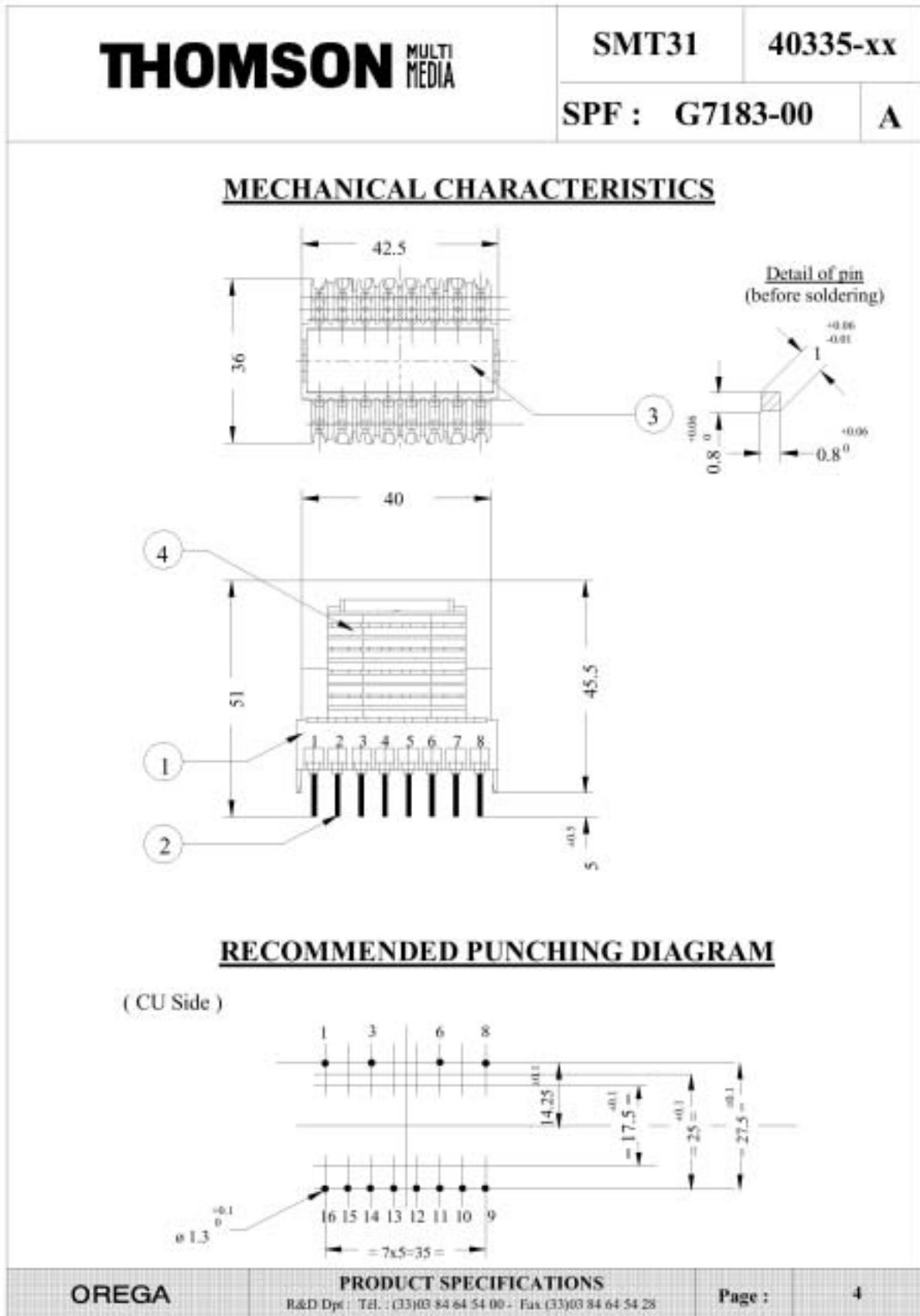

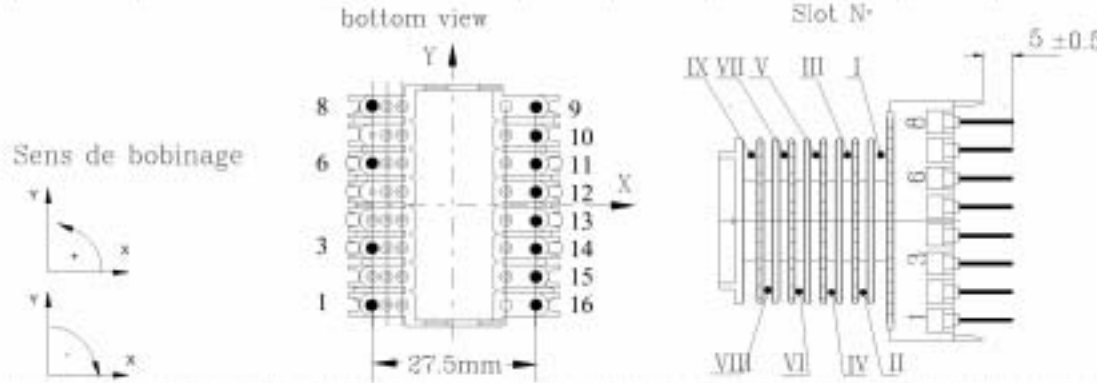
THOMSON MULTI MEDIA			SMT31		40335-xx			
			SPF : G7183-00			A		
WINDING SPECIFICATION								
Slot N°	Winding N°	Voltage / Observations	Nr. of turns	Sense	ØWire (mm)	Start	End	Class of wire
I	1	Aux	4	+	0.28	6	8	Grade 2
	2	Primary	28	+	0.28	3	1	Grade 2
II	3	24 V	7	+	0.28	16	9	Grade 2
	4	24 V	7	-	0.28	9	16	Grade 2
	5	24 V	7	+	0.28	16	9	Grade 2
III	6	Primary	28	+	0.28	3	1	Grade 2
IV	7	24 V	7	+	0.28	15	10	Grade 2
	8	24 V	7	-	0.28	10	15	Grade 2
	9	24 V	7	+	0.28	15	10	Grade 2
V	10	Primary	28	+	0.28	3	1	Grade 2
VI	11	24 V	7	+	0.28	14	11	Grade 2
	12	24 V	7	-	0.28	11	14	Grade 2
	13	24 V	7	+	0.28	14	11	Grade 2
VII	14	Primary	28	+	0.28	3	1	Grade 2
VIII	15	24 V	7	+	0.28	13	12	Grade 2
	16	24 V	7	-	0.28	12	13	Grade 2
	17	24 V	7	+	0.28	13	12	Grade 2
IX	18	Primary	28	+	0.28	3	1	Grade 2
								
OREGA			PRODUCT SPECIFICATIONS			Page : 9		
R&D Dpt - Tél. : (33)03 84 64 54 00 - Fax (33)03 84 64 54 28								
Reproduction is not permitted without THOMSON TELEVISION COMPONENTS FRANCE explicit consent								

Performance Data

Efficiency

Efficiency vs. Line Input Voltage

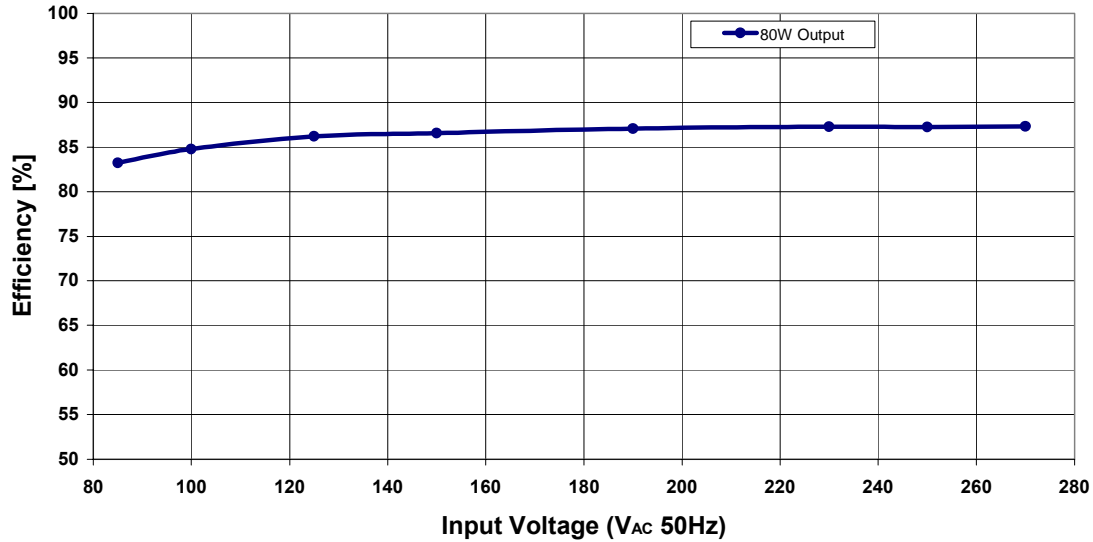

Figure 4 Efficiency vs. Line Input Voltage

Efficiency vs. Output Power

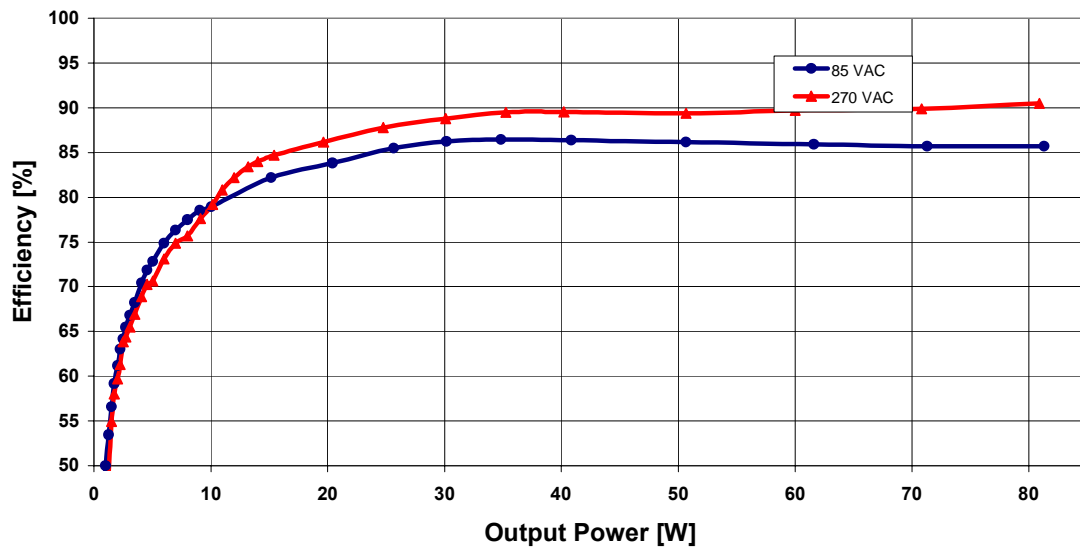

Figure 5 Efficiency vs. Output Power @ Low and High Line 50Hz

No-Load Input Power (Standby)

Standby Power versus Line Voltage @ No Load

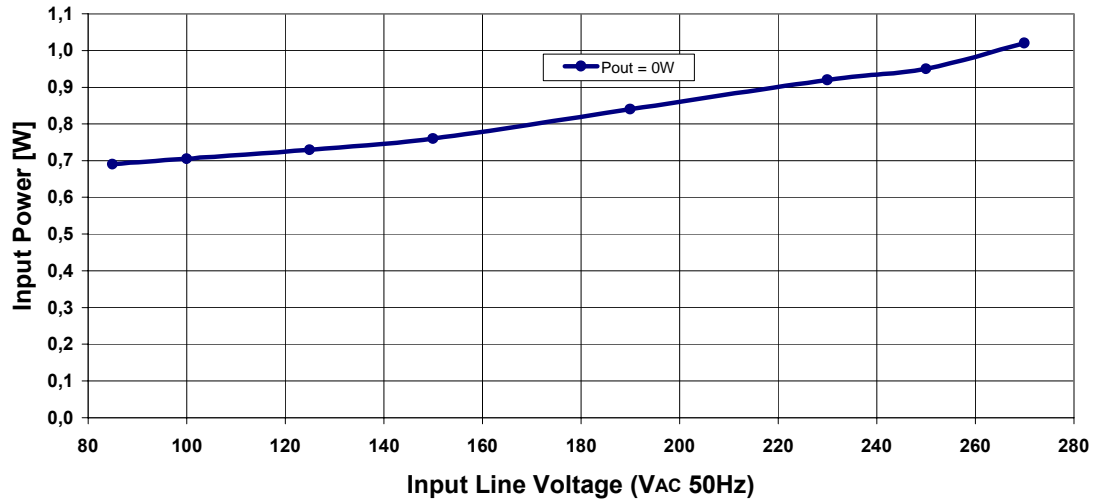

Figure 6 Standby Power vs. Line Input Voltage and No Load Condition ($P_{out} = 0W$)

Regulation and Power Limiting

Line Regulation @ $P_{out} = 80W$

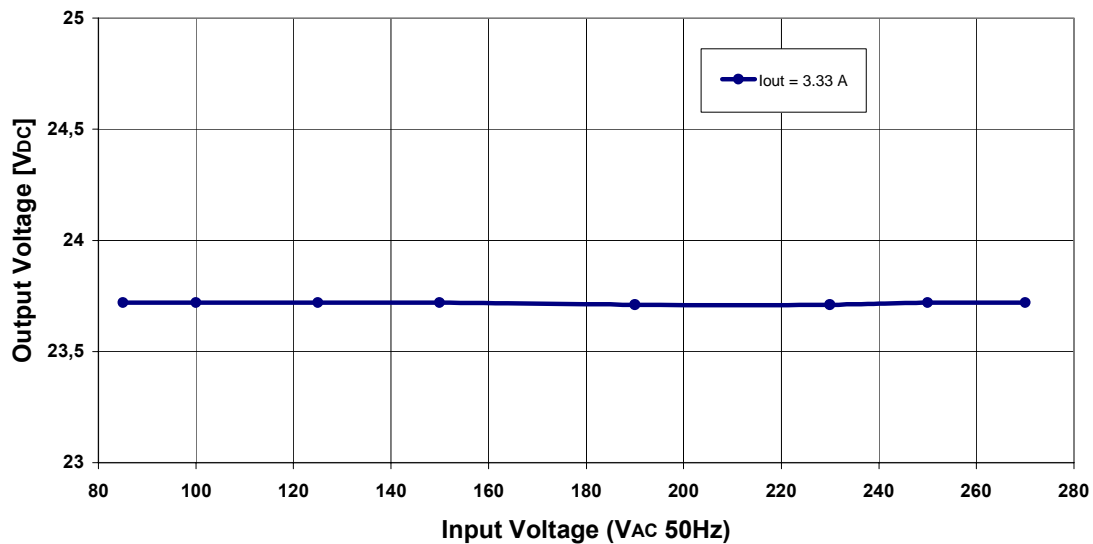

Figure 7 Regulation vs. Line Input Voltage

Load Regulation

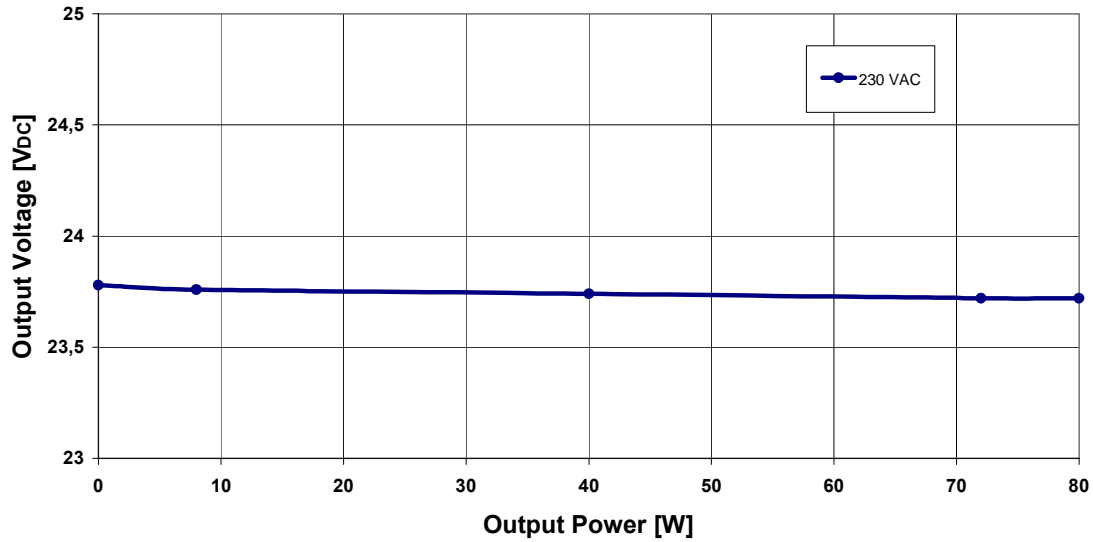

Figure 8 Regulation vs. Load

Maximum Output Power vs. Line Input Voltage

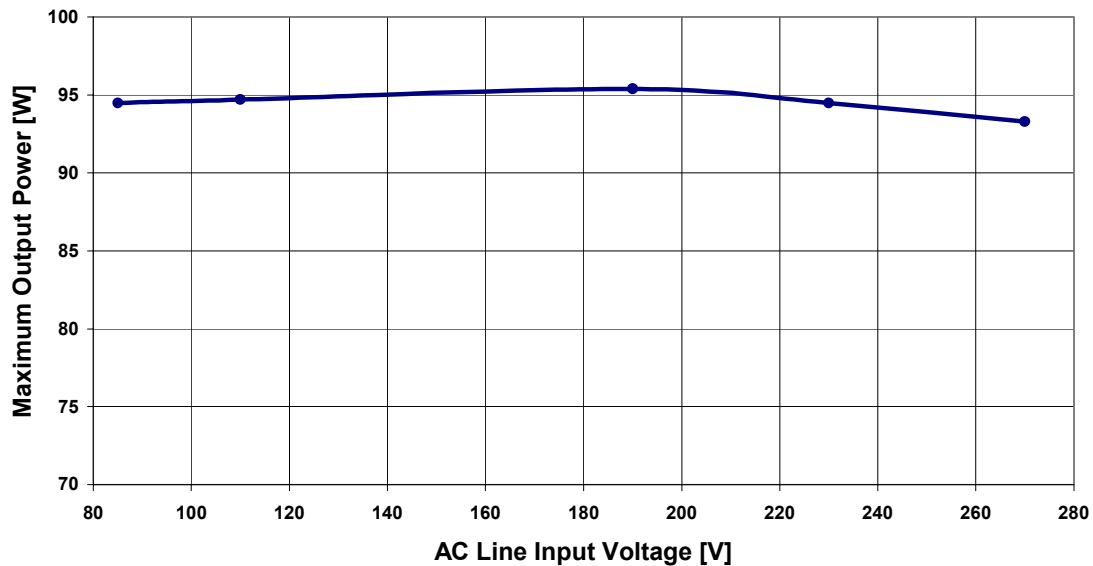

Figure 9 Peak Power (Over Current Shut Off Threshold) vs. Line Input Voltage

Startup Curves (Low Line)

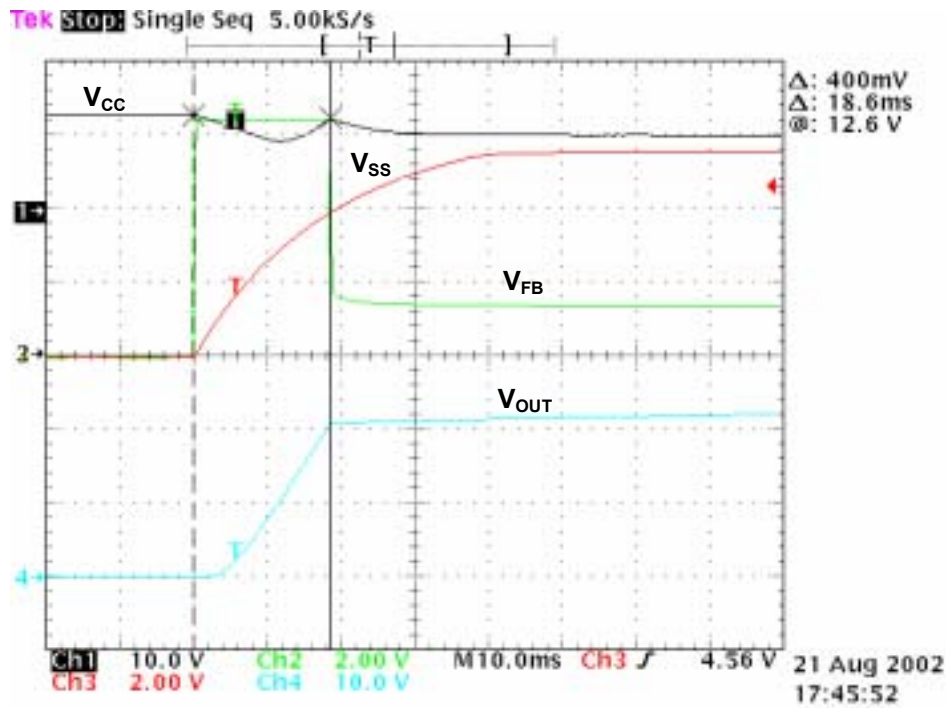

Figure 10 Startup $V_{ACIN} = 85V$ no Load Condition ($P_{OUT} = 0W$)

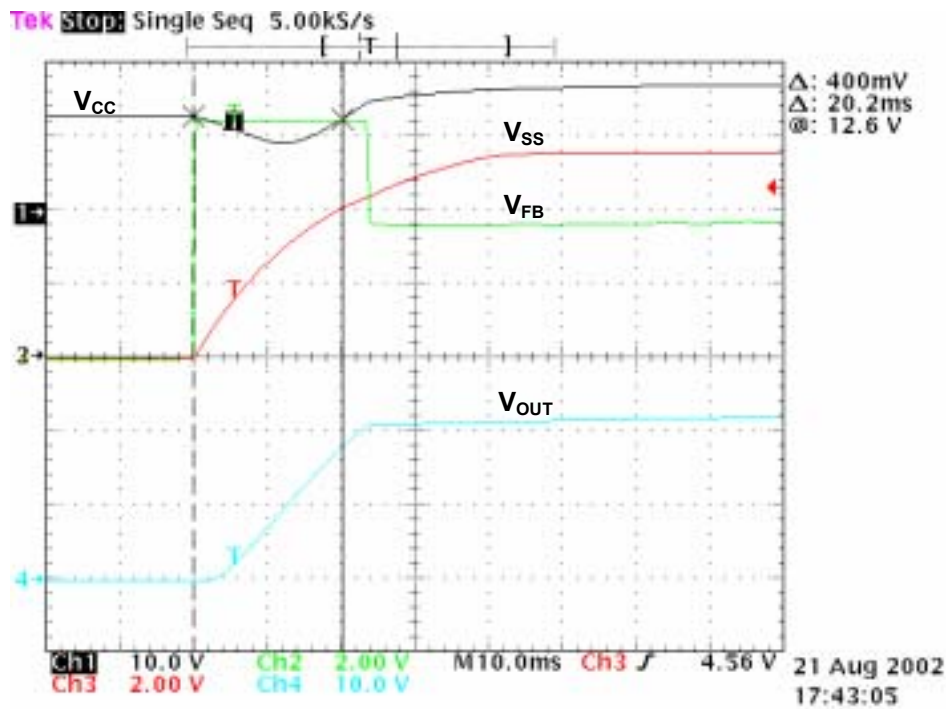

Figure 11 Startup @ $V_{acIn} = 85V$ and nominal Load ($P_{OUT} = 80W$)

Startup Curves (High Line)

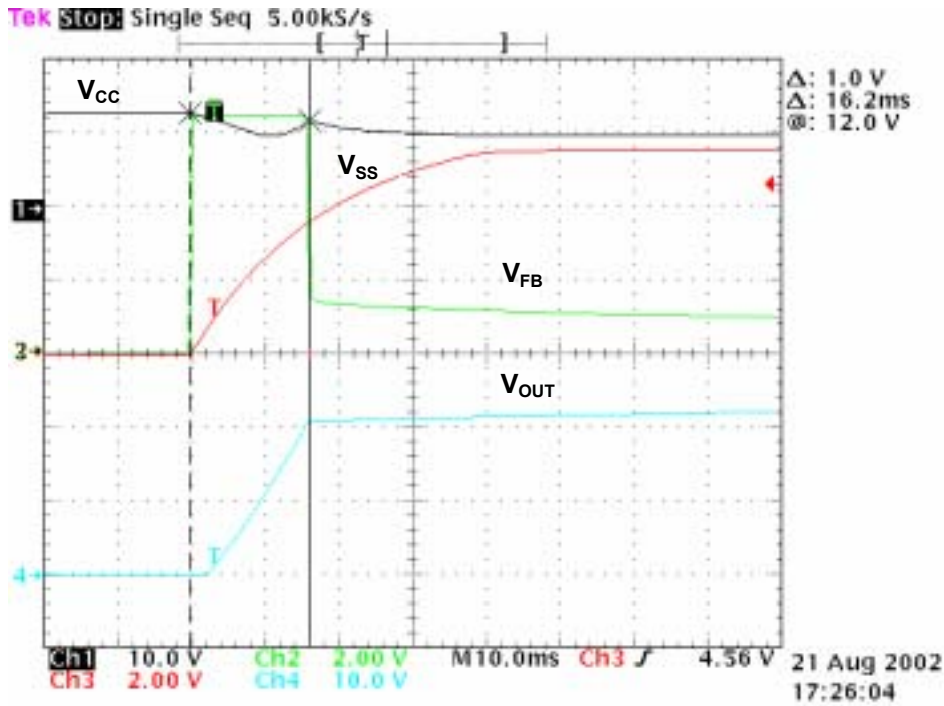

Figure 12 Startup @ 270V_{ACIN} and no Load Condition (P_{OUT} = 0W)

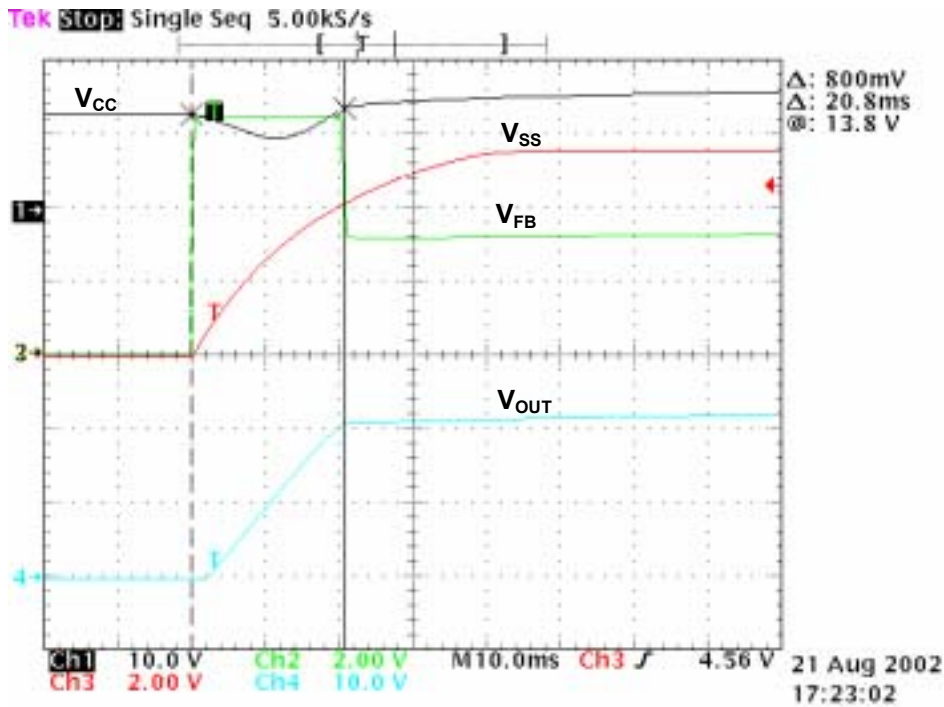

Figure 13 Startup @ Vacin = 270V and nominal Load (P_{OUT} = 80W)

Loadjump

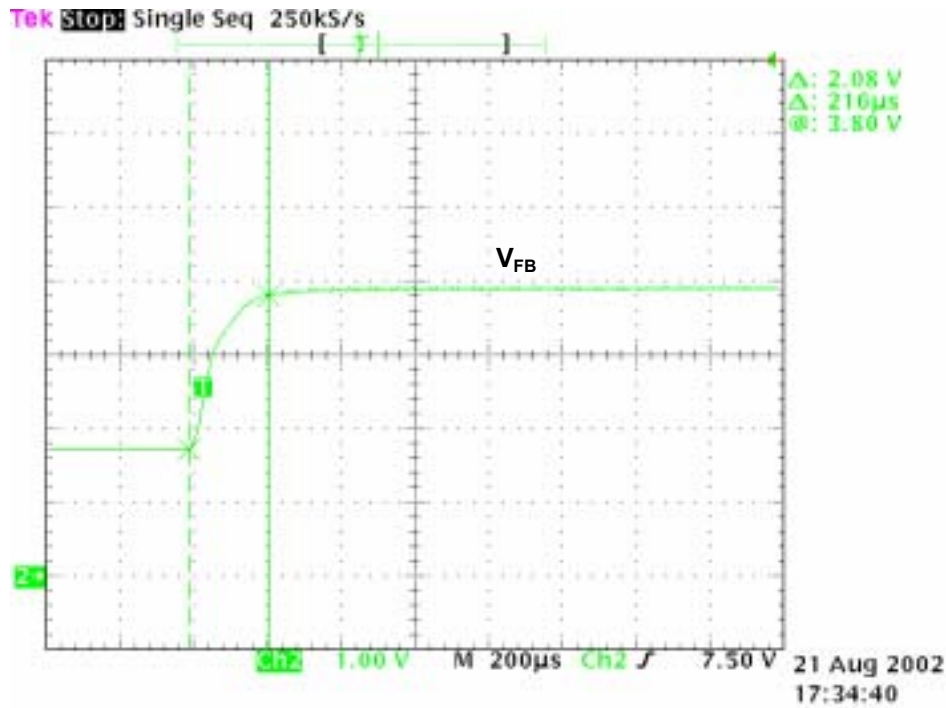

Figure 14 Loadjump form 10% up to 100% at $V_{ACIN} = 85V$

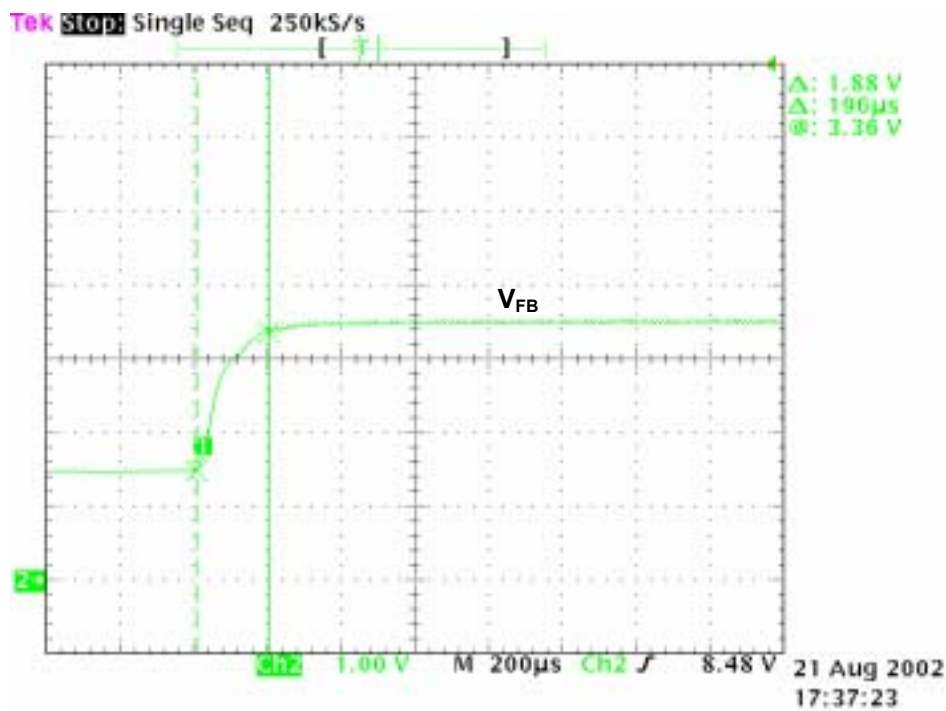

Figure 15 Loadjump form 10% up to 100% at $V_{ACIN} = 270V$

AC Output Voltage Ripple

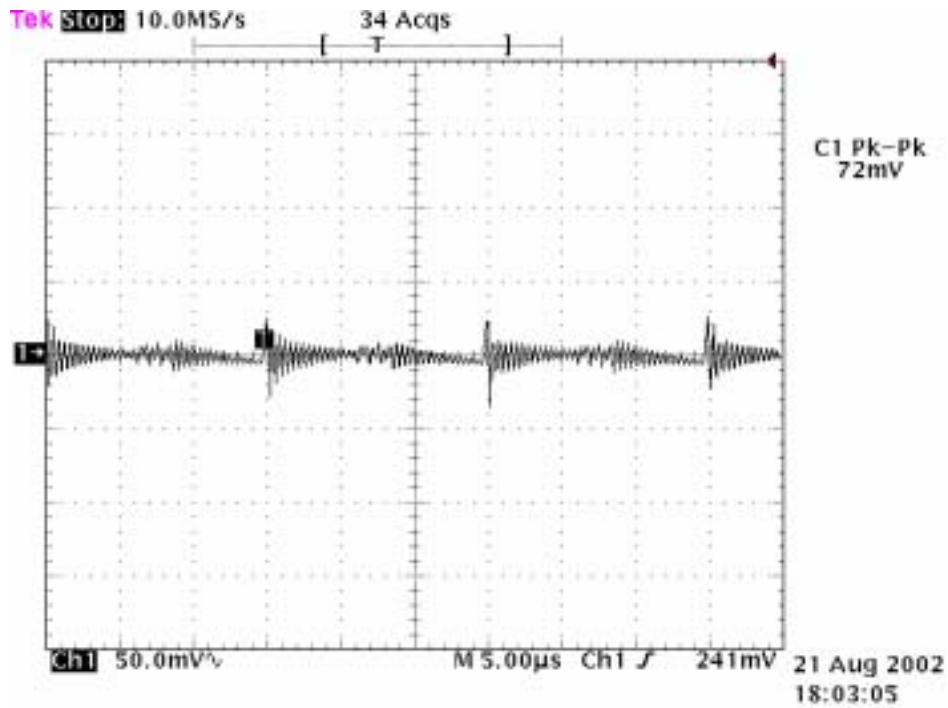

Figure 16 AC Output Voltage Ripple @ $V_{ACIN} = 85V$

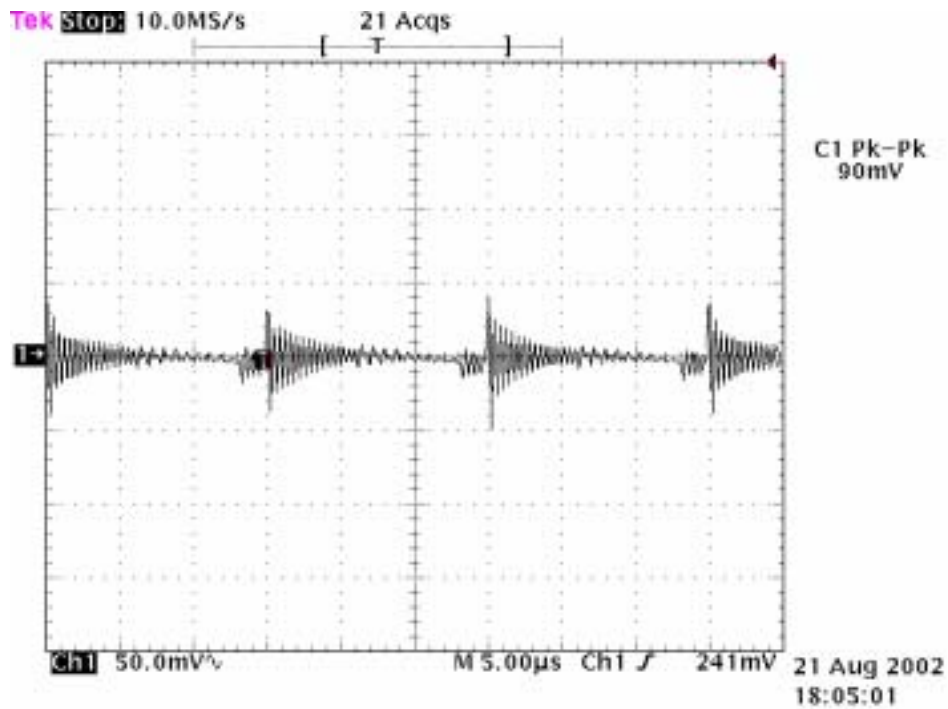

Figure 17 AC Output Voltage Ripple @ $V_{ACIN} = 270V$

Drain Source Voltage and Current

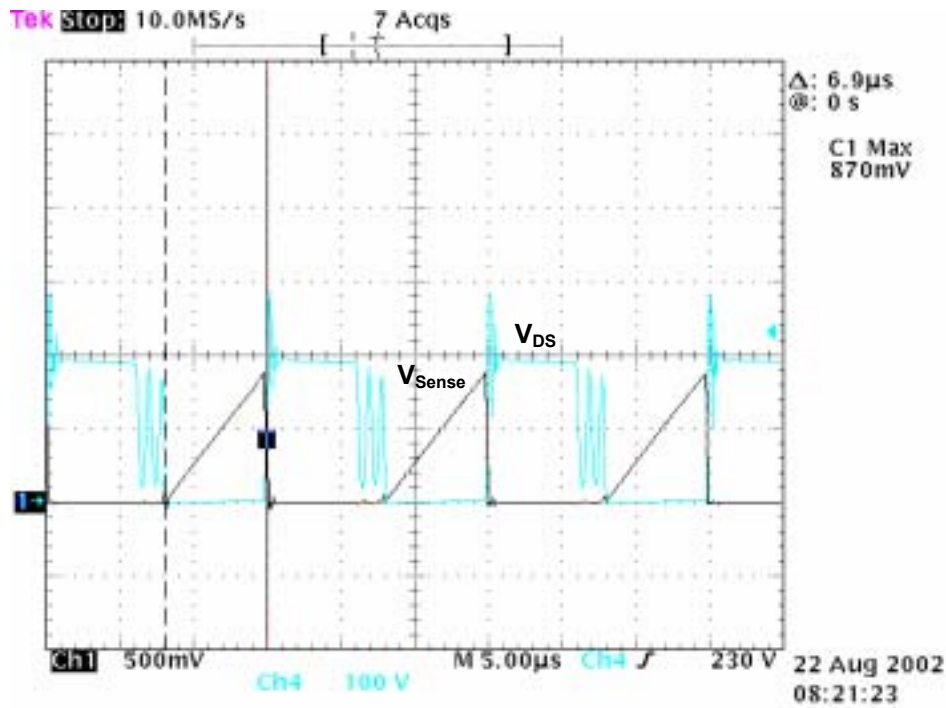

Figure 18 Drain Source Voltage and Current @ $V_{ACIN} = 85V$

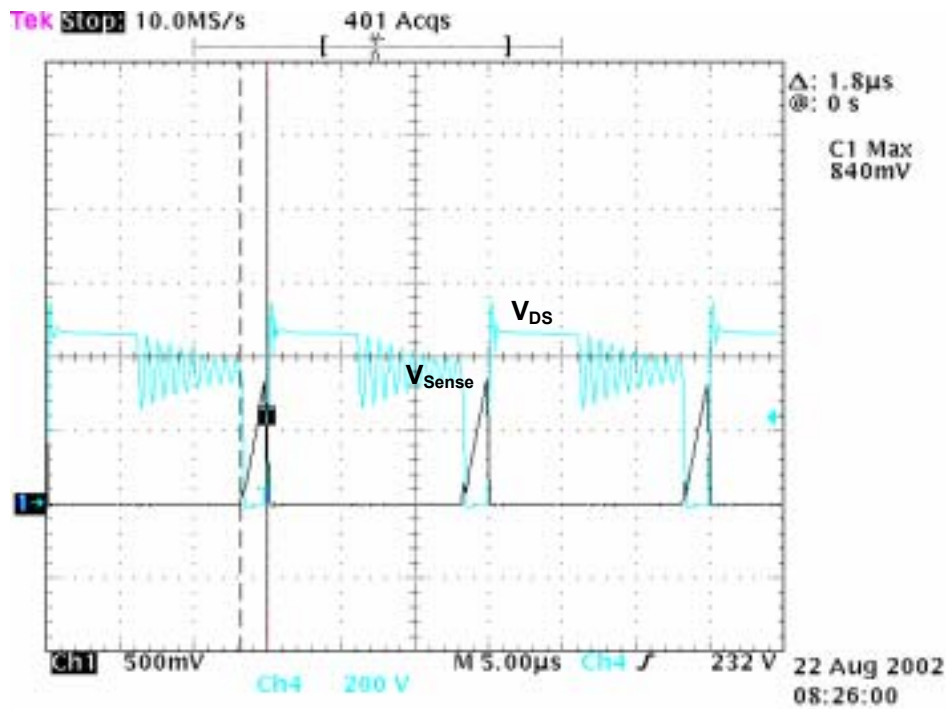

Figure 19 Drain Source Voltage and Current @ $V_{ACIN} = 85V$

Note:

The built-in transformer does **not** comply with EN60950 safety requirements in respect of electrical isolation.

Change service

Issue status	Changes	Date
1.0	First issue	02.05.2002
2.1	BOM Update	02.08.2002
2.2	Performance Data	27.08.2002
2.3	BOM Update	08.11.2002

References

- [1] ICE2AXXX for OFF-Line Switch Mode Power Supplies
Application Note, Infineon Technologies

- [2] CoolSET -II
Off-line SMPS Current Mode Controller with High Voltage CoolMOS on Board
Datasheet, Infineon Technologies

Revision History		
Application Note AN-EVALSF2-ICE2B765P-01		
Actual Release: 2.3 Date: 2002-08-27		Previous Release: V1.0
Page of actual Rel.	Page of prev. Rel.	Subjects changed since last release
--	--	See change service

For questions on technology, delivery and prices please contact the Infineon Technologies Offices in Germany or the Infineon Technologies Companies and Representatives worldwide: see the address list on the last page or our webpage at

<http://www.infineon.com/CoolSET>

CoolMOS™ and CoolSET™ are trademarks of Infineon Technologies AG.

Edition 2002-05--02

**Published by Infineon Technologies AG,
St.-Martin-Strasse 53,
D-81541 München**

**© Infineon Technologies AG 2000.
All Rights Reserved.**

Attention please!

The information herein is given to describe certain components and shall not be considered as warranted characteristics.

Terms of delivery and rights to technical change reserved.

We hereby disclaim any and all warranties, including but not limited to warranties of non-infringement, regarding circuits, descriptions and charts stated herein.

Infineon Technologies is an approved CECC manufacturer.

Information

For further information on technology, delivery terms and conditions and prices please contact your nearest Infineon Technologies Office in Germany or our Infineon Technologies Representatives worldwide (see address list).

Warnings

Due to technical requirements components may contain dangerous substances. For information on the types in question please contact your nearest Infineon Technologies Office.

Infineon Technologies Components may only be used in life-support devices or systems with the express written approval of Infineon Technologies, if a failure of such components can reasonably be expected to cause the failure of that life-support device or system, or to affect the safety or effectiveness of that device or system. Life support devices or systems are intended to be implanted in the human body, or to support and/or maintain and sustain and/or protect human life. If they fail, it is reasonable to assume that the health of the user or other persons may be endangered.