

SERIES: CP60 | **DESCRIPTION:** PELTIER MODULE**FEATURES**

- solid state device
- precise temperature control
- quiet operation

**MODEL**

| MODEL | input voltage ¹ max (Vdc) | input current ² max (A) | internal resistance ³ typ ($\Omega \pm 10\%$) | output Qmax ⁴ | | output ΔT_{max} ⁵ | |
|------------|--|--|--|-----------------------------|-----------------------------|--------------------------------------|------------------------------|
| | | | | T _h =27°C (W) | T _h =50°C (W) | T _h =27°C (°C) | T _h =50°C (°C) |
| CP60133 | 3.8 | 6.0 | 0.50 | 12.2 | 13.6 | 66 | 72 |
| CP60233 | 8.6 | 6.0 | 1.20 | 27.9 | 31.2 | 66 | 72 |
| CP60333 | 15.4 | 6.0 | 2.20 | 50.5 | 56.5 | 66 | 72 |
| CP60140 | 2.1 | 6.0 | 0.29 | 7.1 | 7.9 | 68 | 75 |
| CP60240 | 3.8 | 6.0 | 0.53 | 13.0 | 14.5 | 68 | 75 |
| CP60301540 | 4.2 | 6.0 | 0.57 | 14.5 | 16.1 | 68 | 75 |
| CP60340 | 8.6 | 6.0 | 1.21 | 29.0 | 32.4 | 68 | 75 |
| CP60440 | 15.4 | 6.0 | 2.17 | 53.0 | 59.3 | 68 | 75 |

- Notes:
1. Maximum voltage at ΔT_{max} and T_h=27°C
 2. Maximum current to achieve ΔT_{max}
 3. Measured by AC 4-terminal method at 25°C
 4. Maximum heat absorbed at cold side occurs at I_{max}, V_{max}, and $\Delta T=0^\circ\text{C}$
 5. Maximum temperature difference occurs at I_{max}, V_{max}, and Q=0W (ΔT_{max} measured in a vacuum at 1.3 Pa)

SPECIFICATIONS

| parameter | conditions/description | min | typ | max | units |
|----------------------------|---|-----|-----|-----|-------|
| solder melting temperature | connection between thermoelectric pairs | 235 | | | °C |
| | CP60133, CP60233, CP60333, CP60301540 all other models | 138 | | | °C |
| assembly compression | | | | 1 | MPa |
| hot side plate | | | | 80 | °C |
| RoHS | yes | | | | |

MECHANICAL DRAWING

units: mm

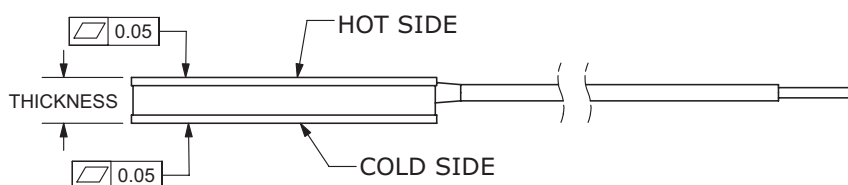

| | MATERIAL | PLATING |
|---------------|---|---------|
| ceramic plate | 96% AL ₂ O ₃ | |
| wire leads | 20 AWG | tin |
| sealer | silicon rubber 703 RTV (between cold and hot side plates) | |
| joint cover | silicon rubber 703 RTV | |
| marking | P/N & S/N printed on cold side surface | |

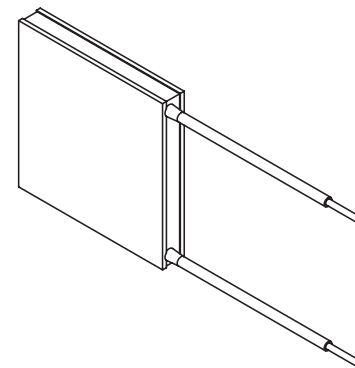
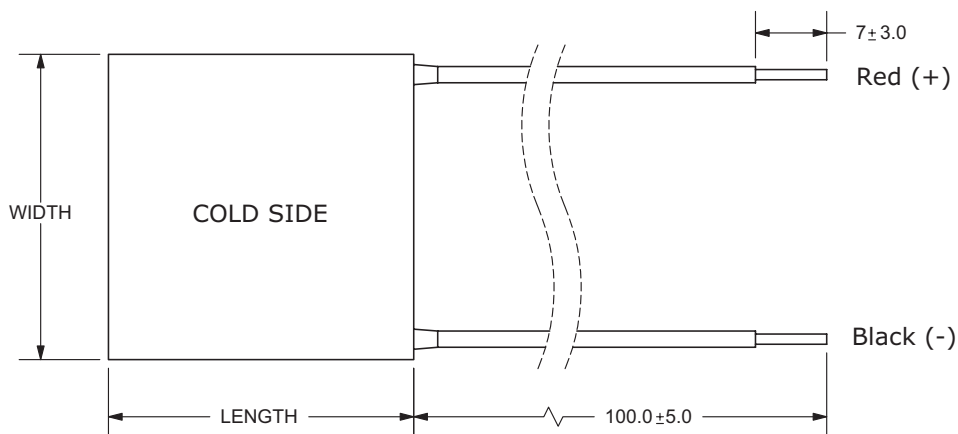

| MODEL NO. | LENGTH (mm) | WIDTH (mm) | THICKNESS (mm) |
|------------|-------------|------------|----------------|
| CP60133 | 15 ±0.3 | 15 ±0.3 | 3.22 ±0.1 |
| CP60233 | 20 ±0.3 | 20 ±0.3 | 3.22 ±0.1 |
| CP60333 | 30 ±0.3 | 30 ±0.3 | 3.22 ±0.1 |
| CP60140 | 15 ±0.3 | 15 ±0.3 | 4.0 ±0.1 |
| CP60240 | 20 ±0.3 | 20 ±0.3 | 4.0 ±0.1 |
| CP60301540 | 30 ±0.3 | 15 ±0.3 | 4.0 ±0.1 |
| CP60340 | 30 ±0.3 | 30 ±0.3 | 4.0 ±0.1 |
| CP60440 | 40 ±0.3 | 40 ±0.3 | 4.0 ±0.1 |

CP60133 PERFORMANCE (Th=27°C)

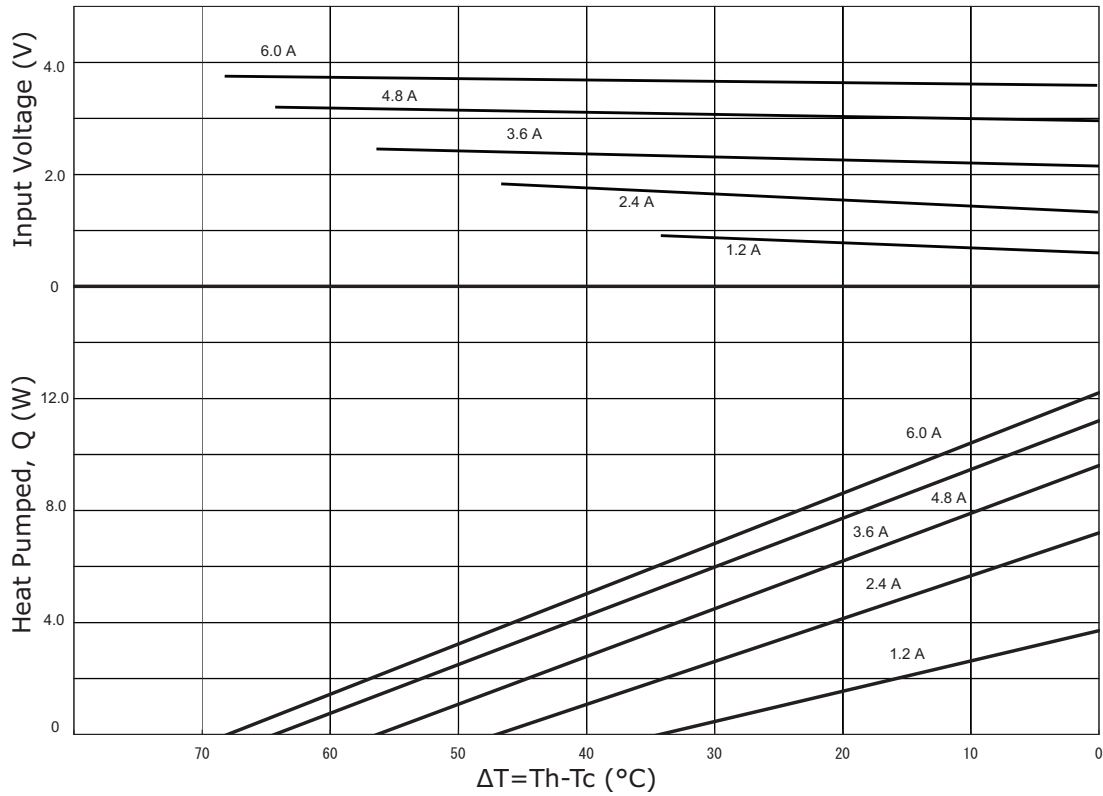

CP60133 PERFORMANCE (Th=50°C)

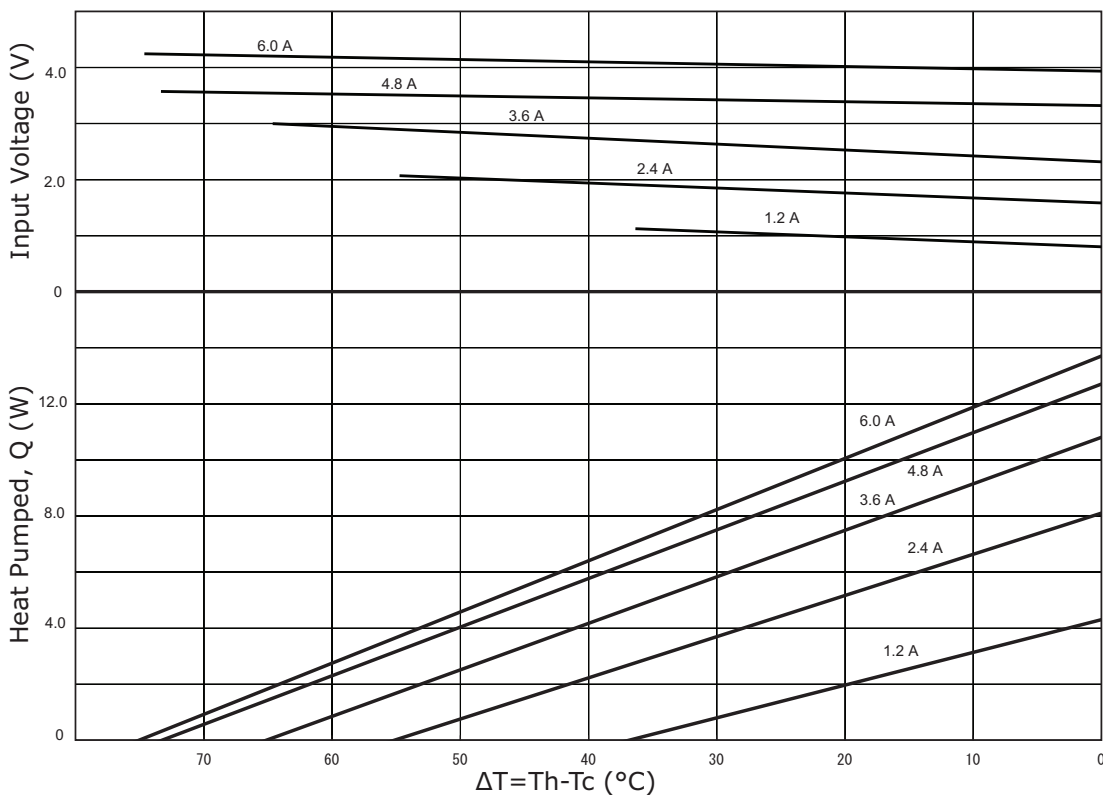

CP60233 PERFORMANCE (Th=27°C)

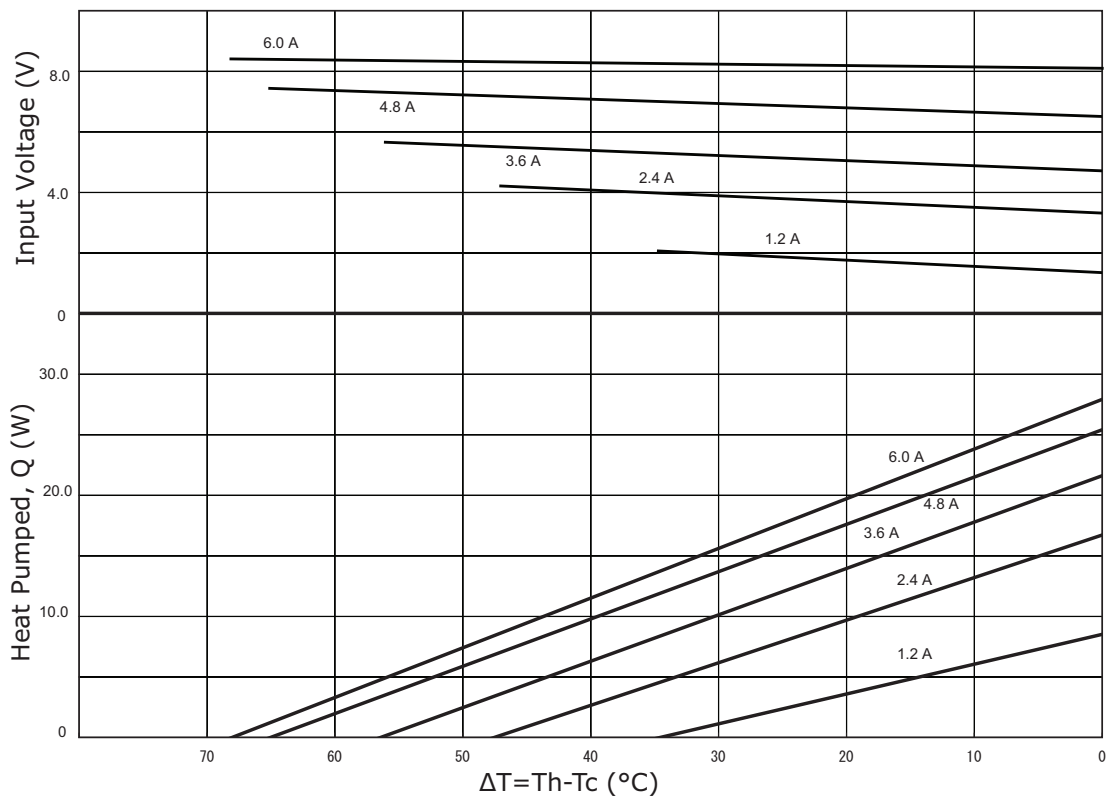

CP60233 PERFORMANCE (Th=50°C)

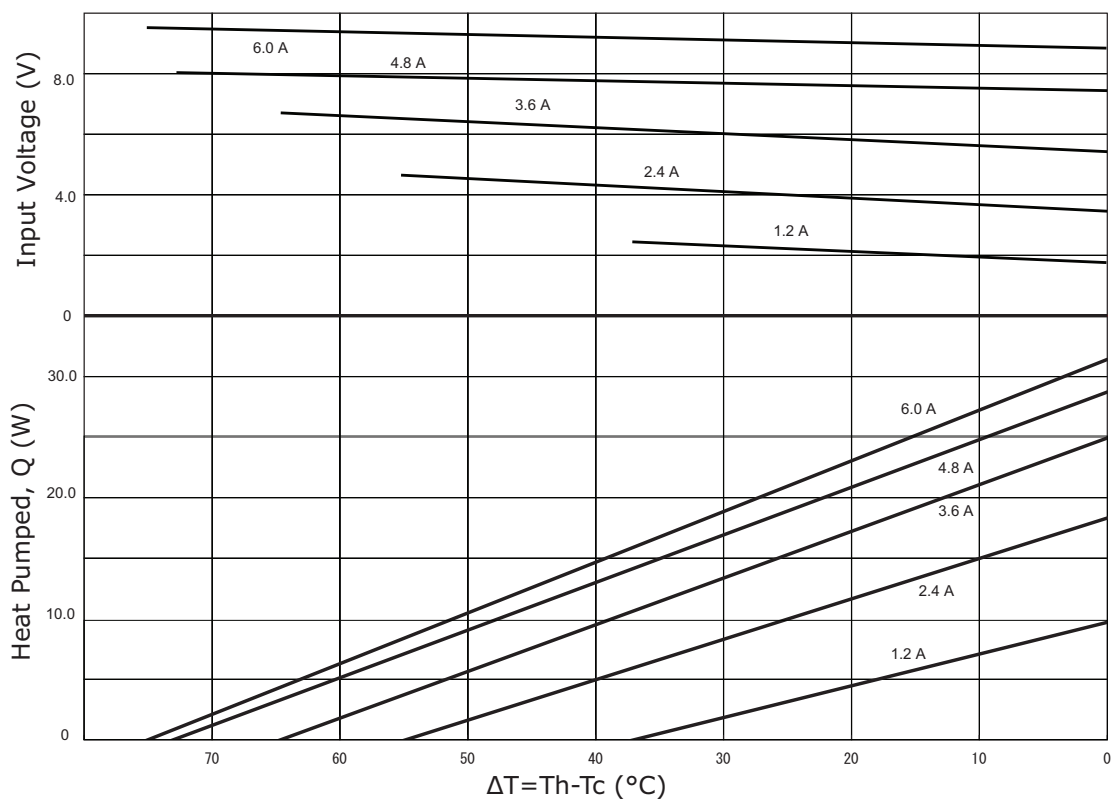

CP60333 PERFORMANCE (Th=27°C)

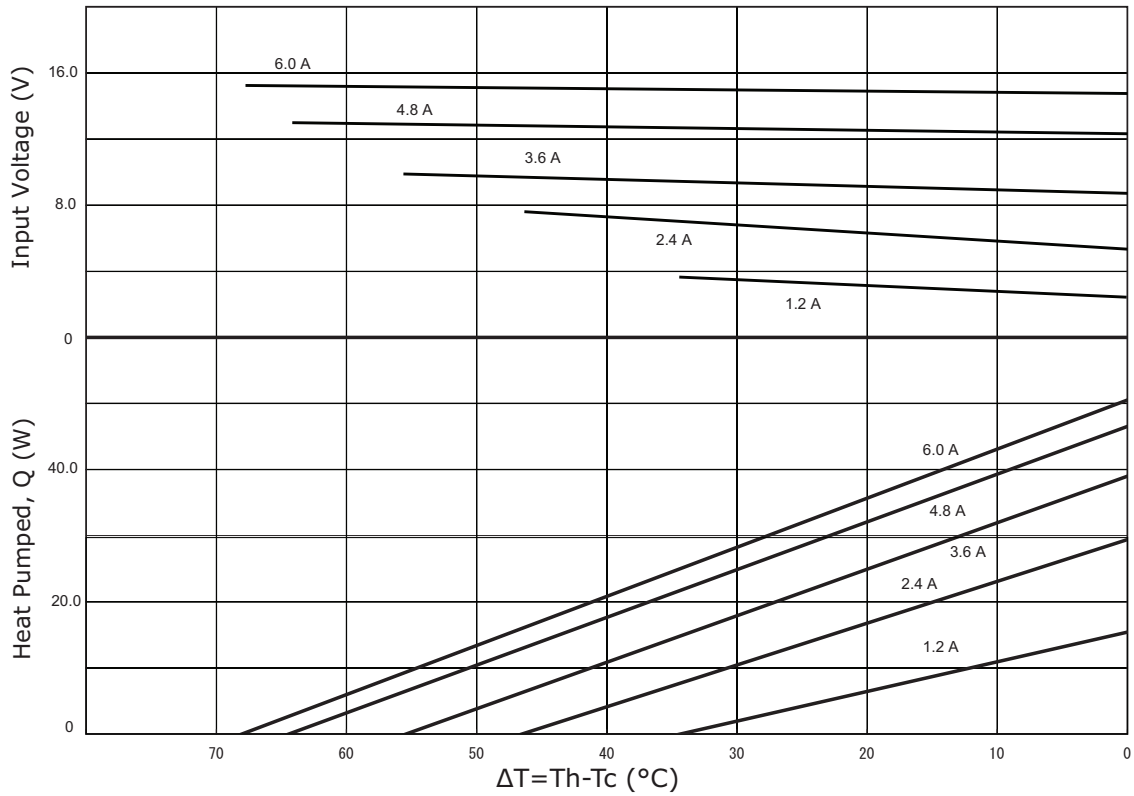

CP60333 PERFORMANCE (Th=50°C)

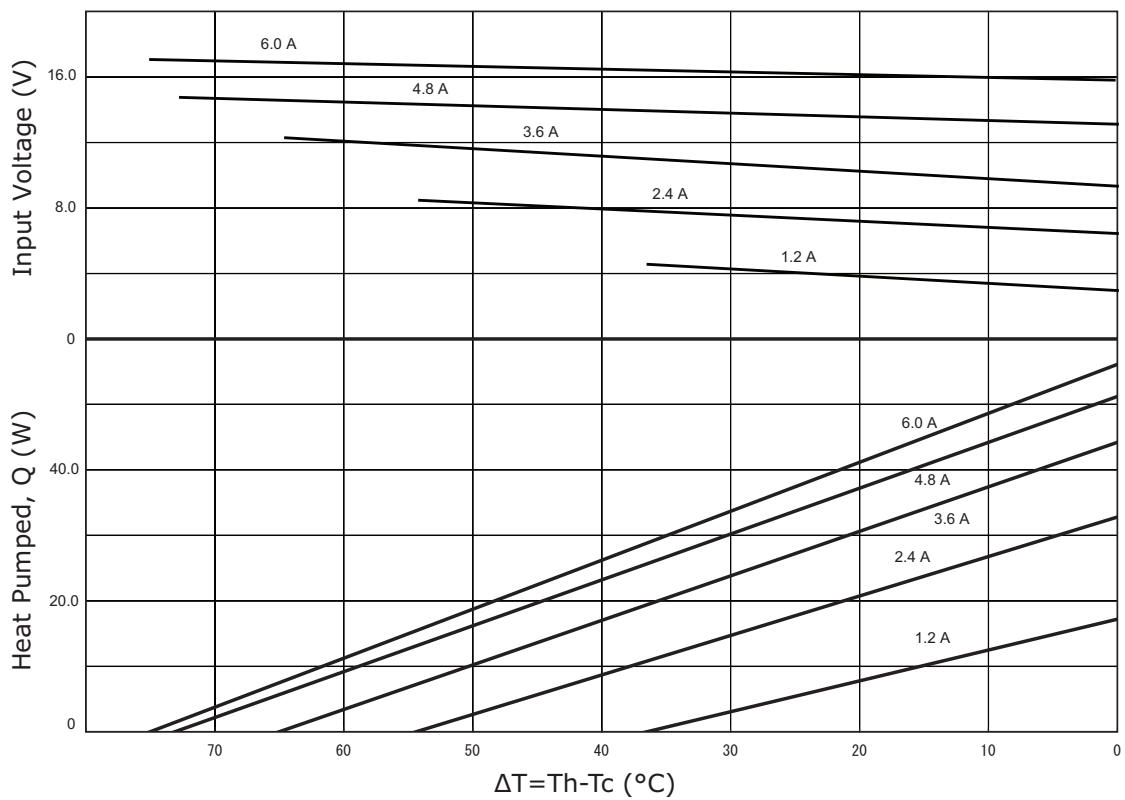

CP60140 PERFORMANCE (Th=27°C)

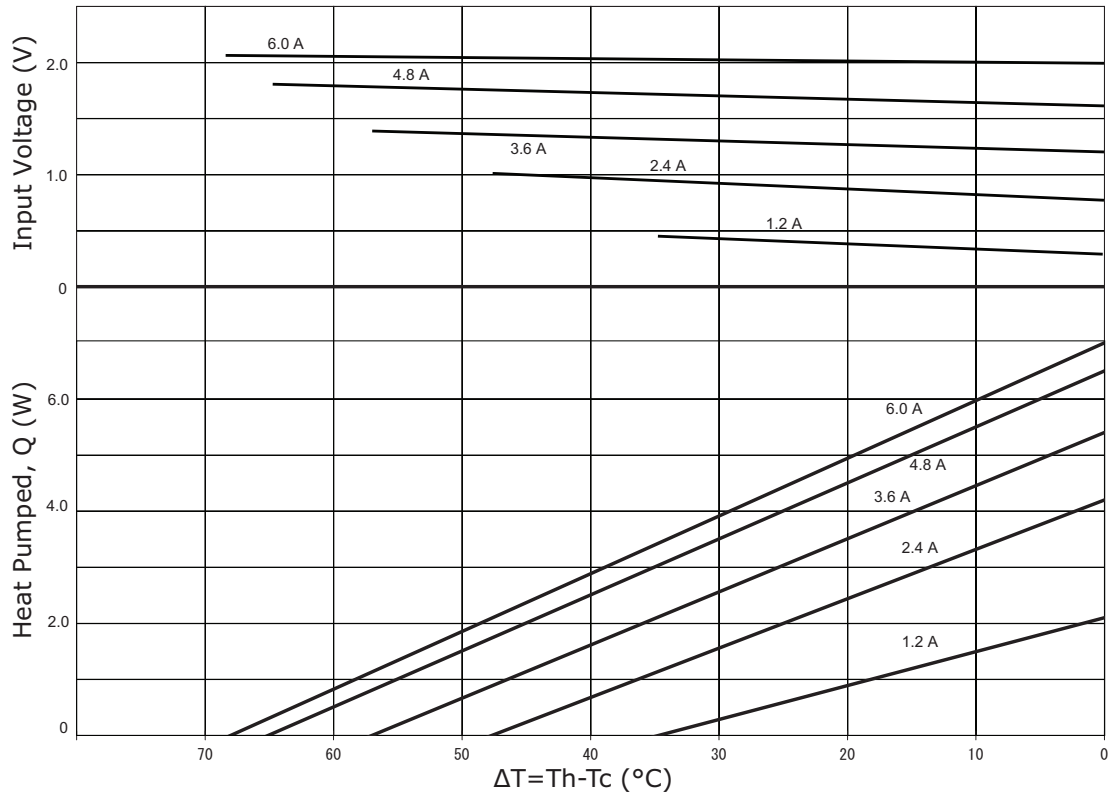

CP60140 PERFORMANCE (Th=50°C)

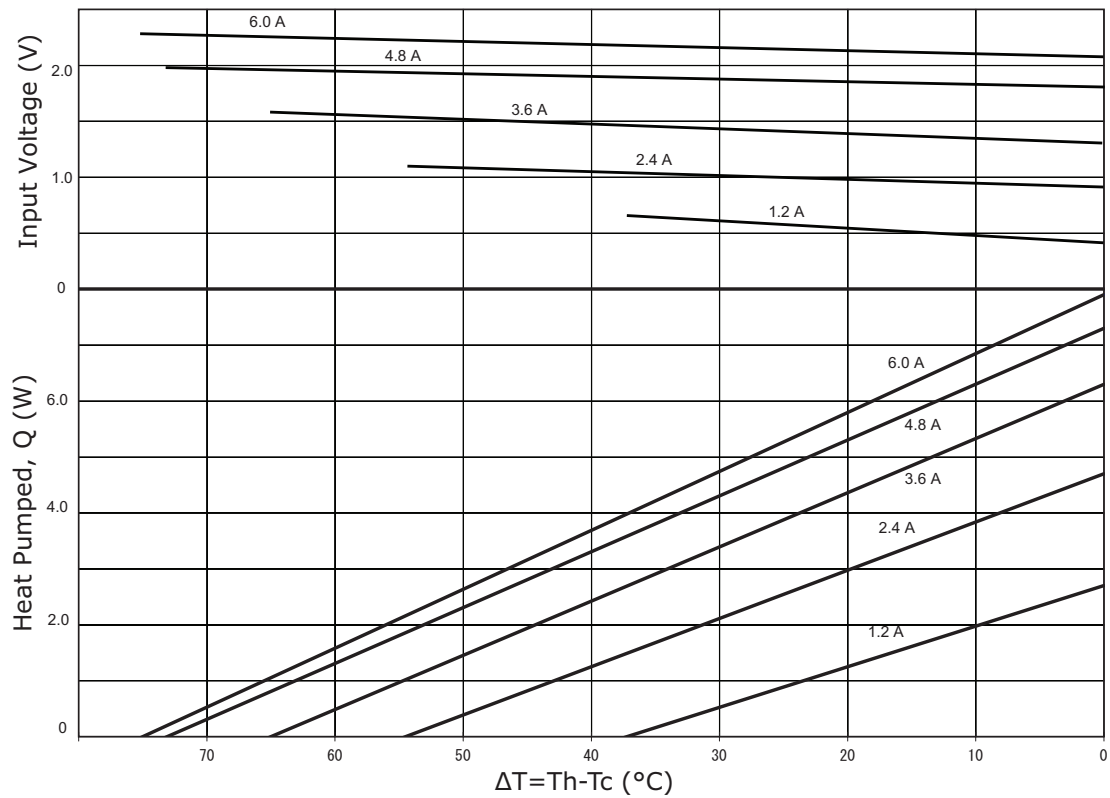

CP60240 PERFORMANCE (Th=27°C)

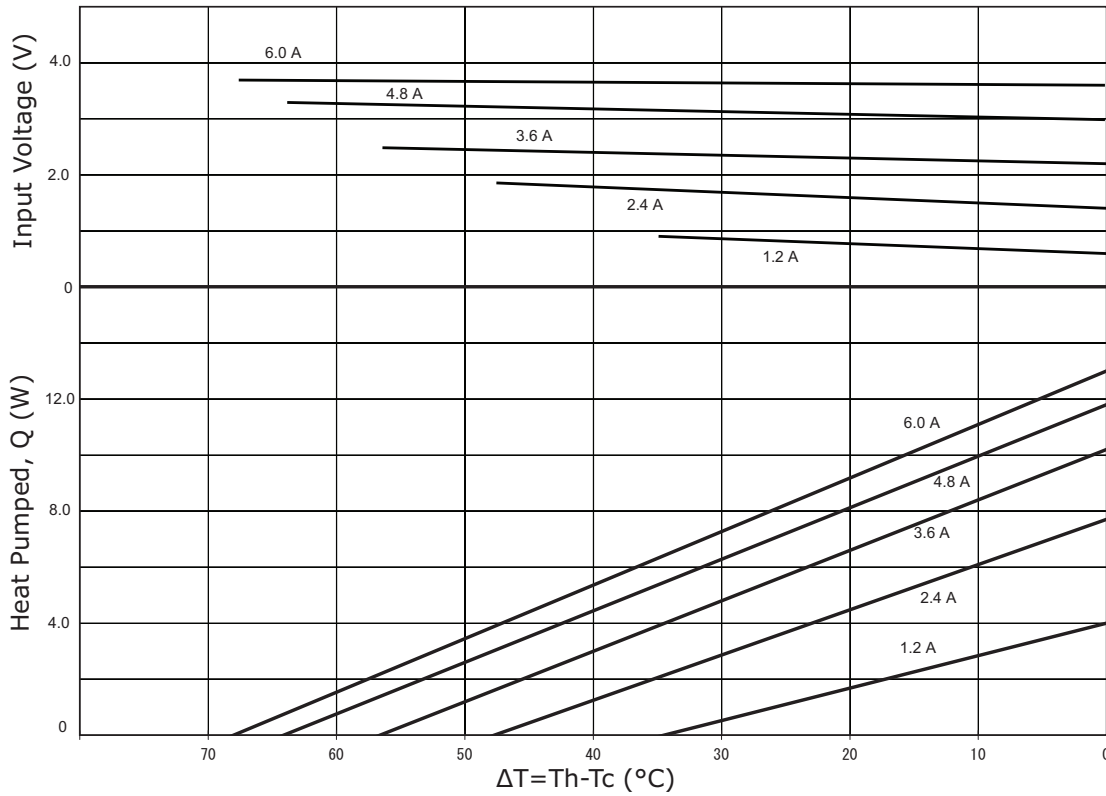

CP60240 PERFORMANCE (Th=50°C)

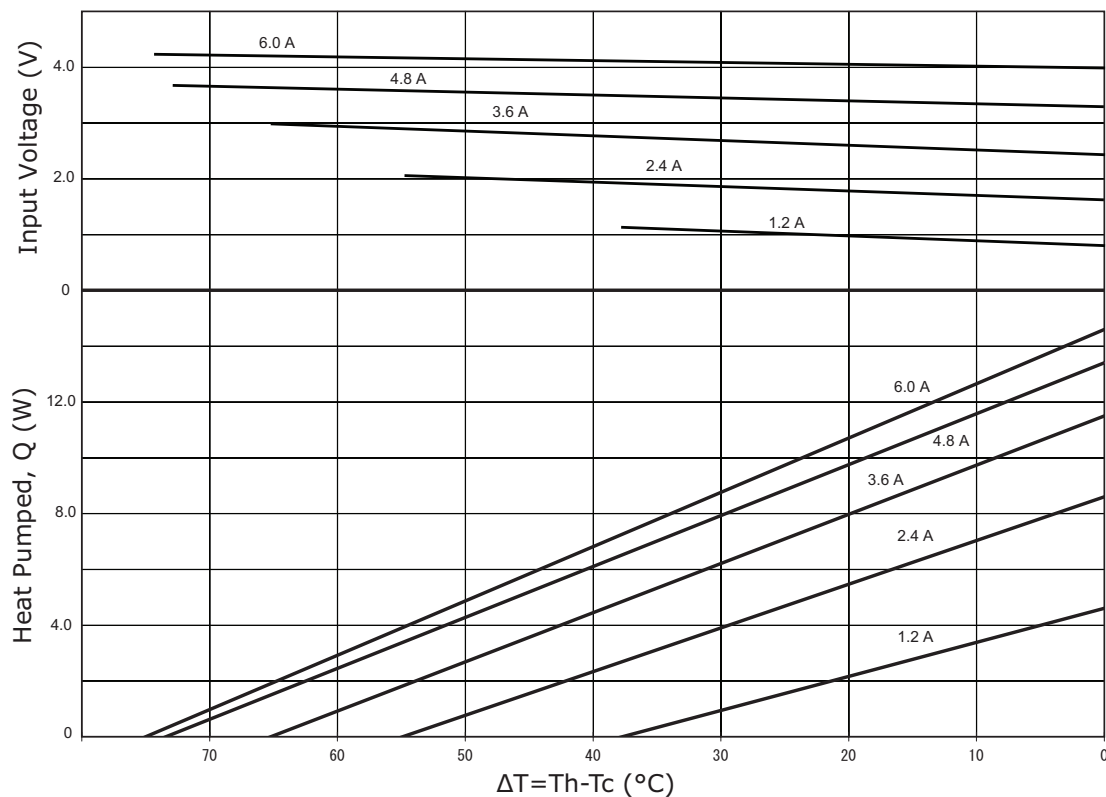

CP60301540 PERFORMANCE (Th=27°C)

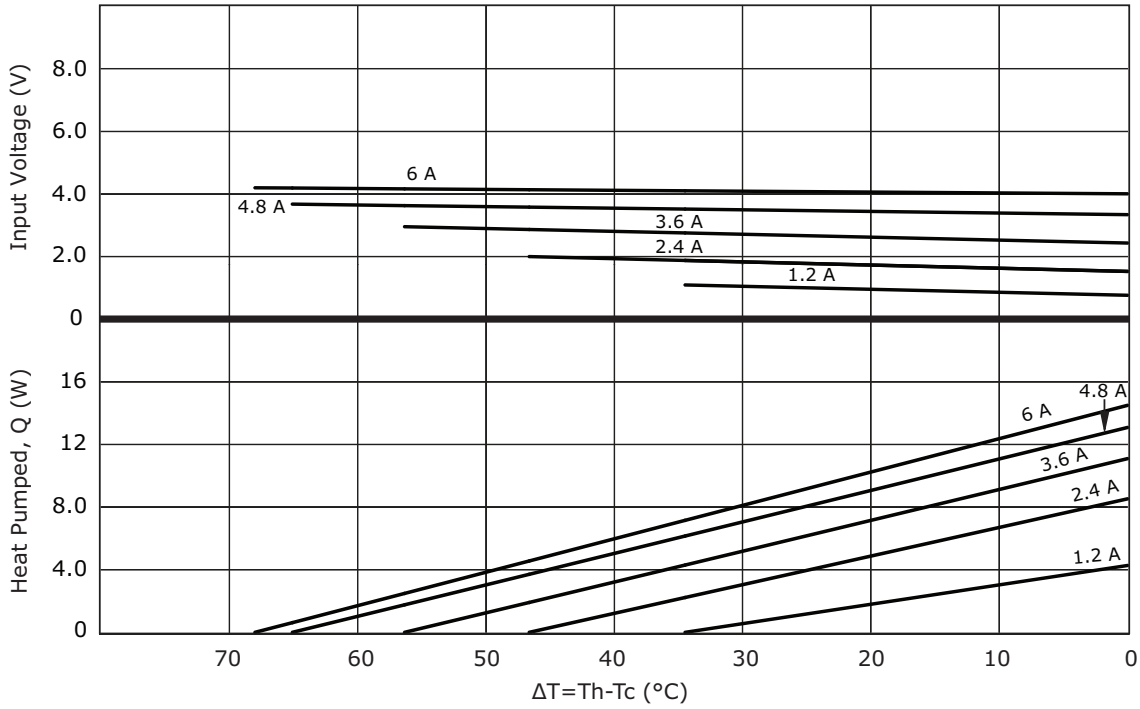

CP60301540 PERFORMANCE (Th=50°C)

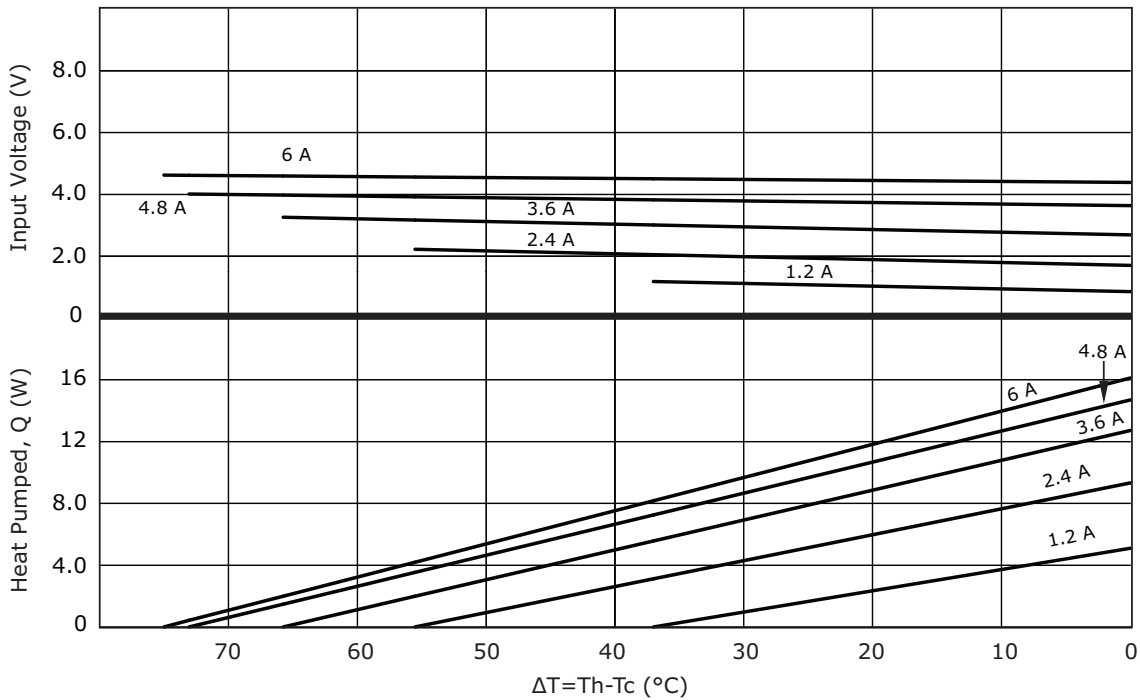

CP60340 PERFORMANCE (Th=27°C)

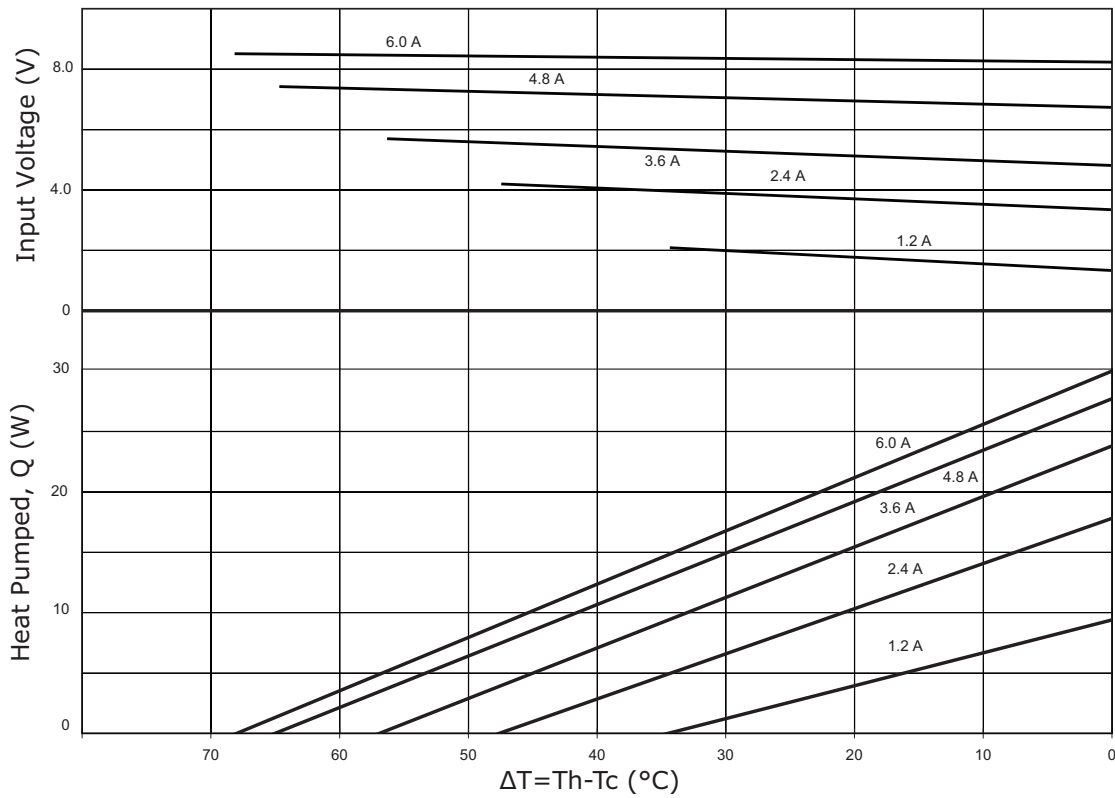

CP60340 PERFORMANCE (Th=50°C)

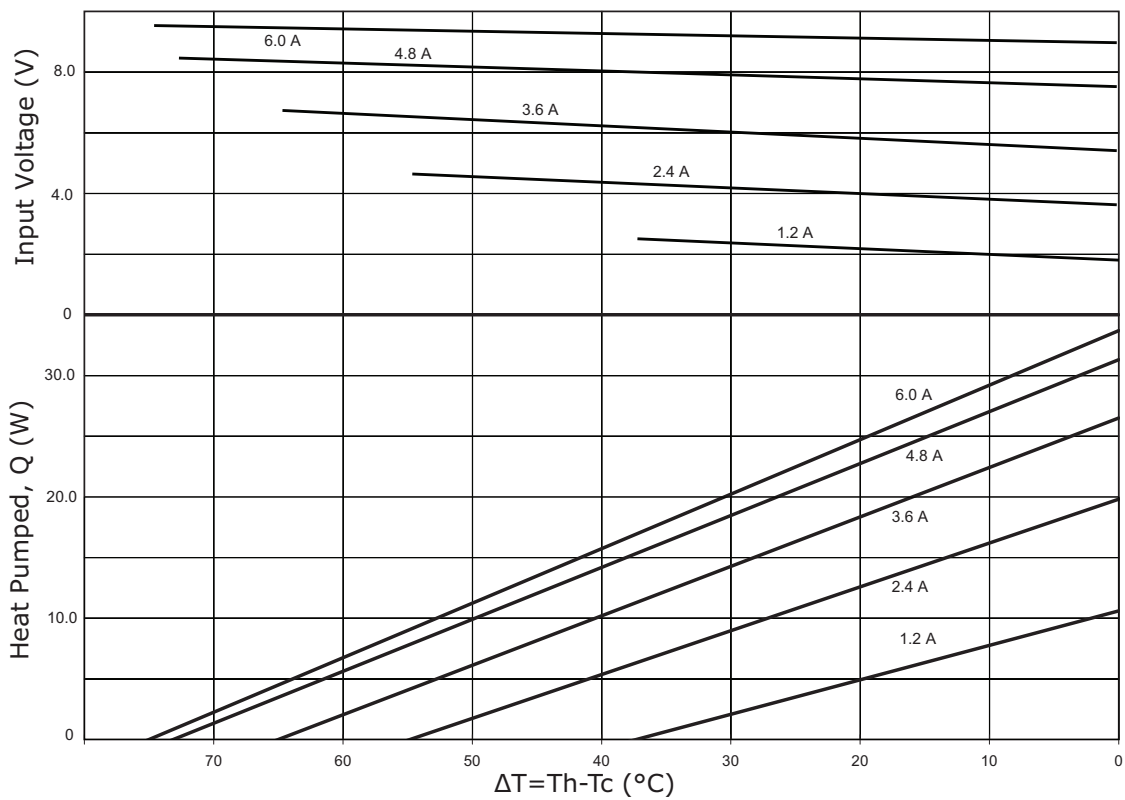

CP60440 PERFORMANCE (Th=27°C)

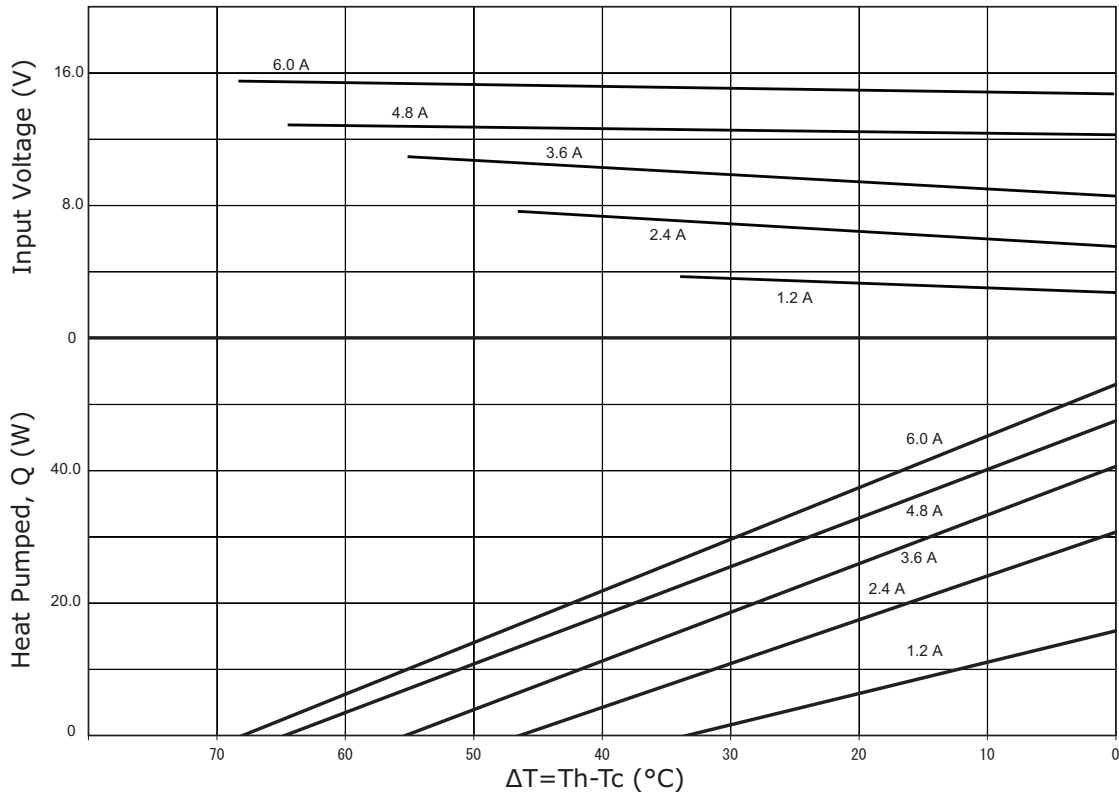

CP60440 PERFORMANCE (Th=50°C)

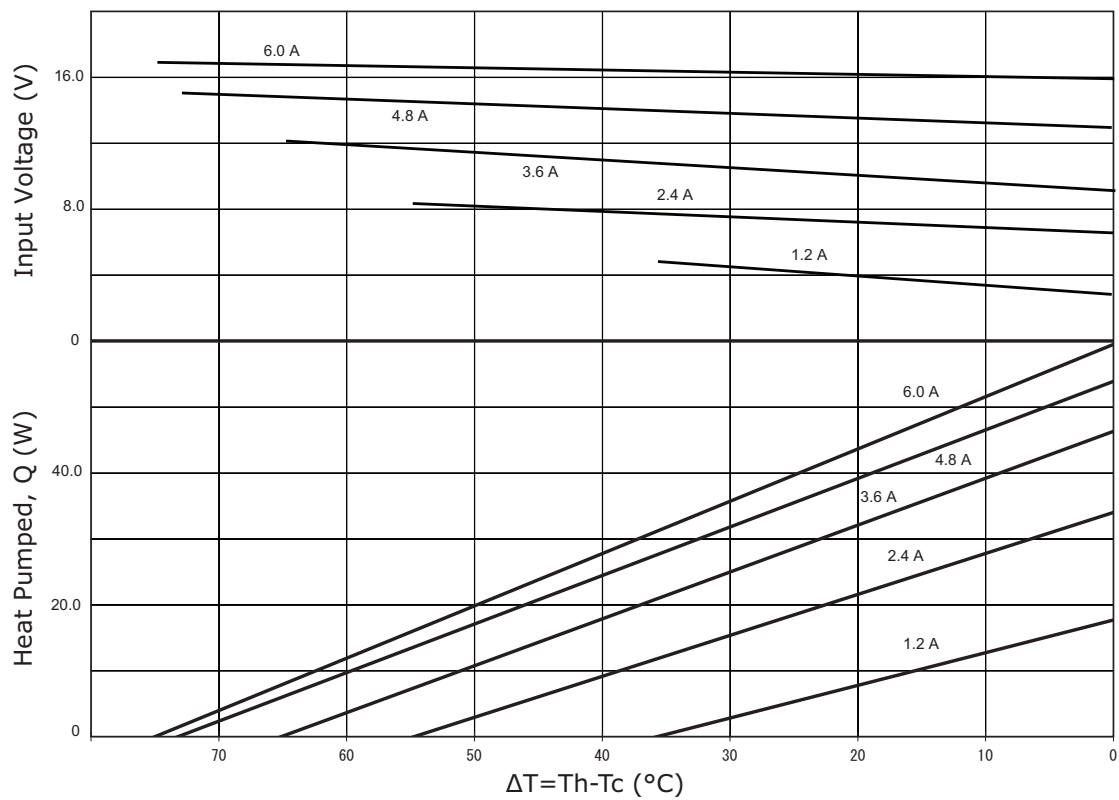

REVISION HISTORY

| rev. | description | date |
|------|---|------------|
| 1.0 | initial release | 09/03/2009 |
| 1.01 | applied new template | 05/08/2012 |
| 1.02 | added new models | 09/09/2016 |
| 1.03 | changed thickness of CP60133, CP60233, CP60333, CP60301540 models | 09/20/2018 |
| 1.04 | brand update | 10/28/2019 |

The revision history provided is for informational purposes only and is believed to be accurate.

CUI DEVICES

CUI Devices offers a one (1) year limited warranty. Complete warranty information is listed on our website.

CUI Devices reserves the right to make changes to the product at any time without notice. Information provided by CUI Devices is believed to be accurate and reliable. However, no responsibility is assumed by CUI Devices for its use, nor for any infringements of patents or other rights of third parties which may result from its use.

CUI Devices products are not authorized or warranted for use as critical components in equipment that requires an extremely high level of reliability. A critical component is any component of a life support device or system whose failure to perform can be reasonably expected to cause the failure of the life support device or system, or to affect its safety or effectiveness.