

POWER SCHOTTKY RECTIFIER

MAIN PRODUCT CHARACTERISTICS

I_{F(AV)}	2 x 40 A
V_{RRM}	60 V
T_j (max)	150 °C
V_F (max)	0.56 V

FEATURES AND BENEFITS

- VERY SMALL CONDUCTION LOSSES
- NEGLIGIBLE SWITCHING LOSSES
- EXTREMELY FAST SWITCHING
- LOW FORWARD VOLTAGE DROP
- LOW THERMAL RESISTANCE
- AVALANCHE CAPABILITY SPECIFIED

DESCRIPTION

Dual center tap Schottky rectifier suited for CAD computers and servers.

Packaged in Max247, STPS80L60CY is intended for use in low voltage, high frequency switching power supplies, free wheeling and polarity protection applications.

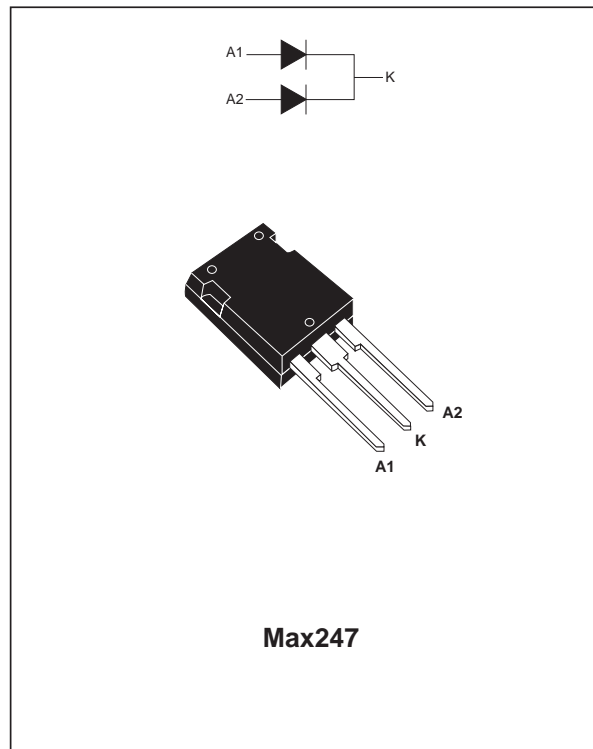

ABSOLUTE RATINGS (limiting values, per diode)

Symbol	Parameter		Value	Unit	
V _{RRM}	Repetitive peak reverse voltage		60	V	
I _{F(RMS)}	RMS forward current		56	A	
I _{F(AV)}	Average forward current	T _c = 130°C	Per diode	40	A
		δ = 0.5	Per device	80	
I _{FSM}	Surge non repetitive forward current	tp = 10 ms sinusoidal	400	A	
I _{RRM}	Repetitive peak reverse current	tp = 2 μs square F = 1kHz	2	A	
P _{ARM}	Repetitive peak avalanche power	tp = 1 μs T _j = 25°C	20000	W	
T _{stg}	Storage temperature range		- 55 to + 150	°C	
T _j	Maximum operating junction temperature *		150	°C	
dV/dt	Critical rate of rise of reverse voltage		10000	V/μs	

* : $\frac{dP_{tot}}{dT_j} < \frac{1}{R_{th}(j-a)}$ thermal runaway condition for a diode on its own heatsink

STPS80L60CY

THERMAL RESISTANCES

Symbol	Parameter		Value	Unit
R _{th(j-c)}	Junction to case	Per diode	0.70	°C/W
		Total	0.50	
R _{th(c)}		Coupling	0.3	

When the diodes 1 and 2 are used simultaneously :
 $\Delta T_j(\text{diode 1}) = P(\text{diode 1}) \times R_{th(j-c)}(\text{Per diode}) + P(\text{diode 2}) \times R_{th(c)}$

STATIC ELECTRICAL CHARACTERISTICS (per diode)

Symbol	Parameter	Tests conditions		Min.	Typ.	Max.	Unit
I _R *	Reverse leakage current	T _j = 25°C	V _R = V _{RRM}			1.8	mA
		T _j = 125°C			0.4	0.9	
V _F *	Forward voltage drop	T _j = 25°C	I _F = 40 A			0.57	V
		T _j = 125°C			0.50	0.56	
		T _j = 25°C	I _F = 80 A			0.78	
		T _j = 125°C			0.69	0.77	

Pulse test : * t_p = 380 μs, δ < 2%

To evaluate the maximum conduction losses use the following equation :
 $P = 0.36 \times I_{F(AV)} + 0.005 \times I_{F(RMS)}^2$

Fig. 1: Conduction losses versus average current.

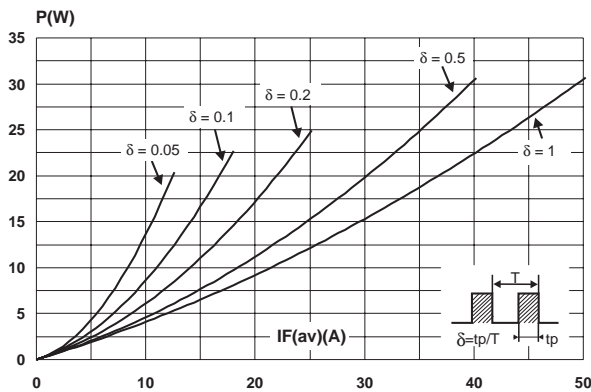

Fig. 3: Normalized avalanche power derating versus pulse duration.

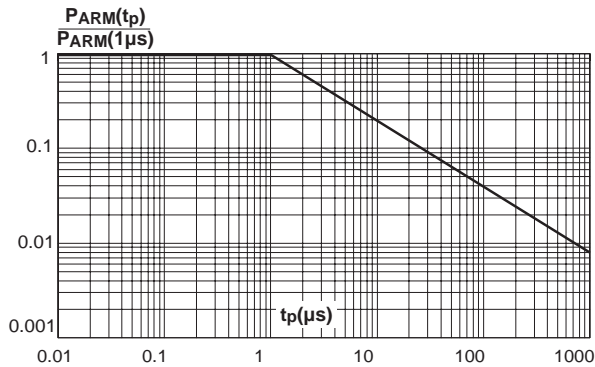

Fig. 2: Average forward current versus ambient temperature (δ = 0.5).

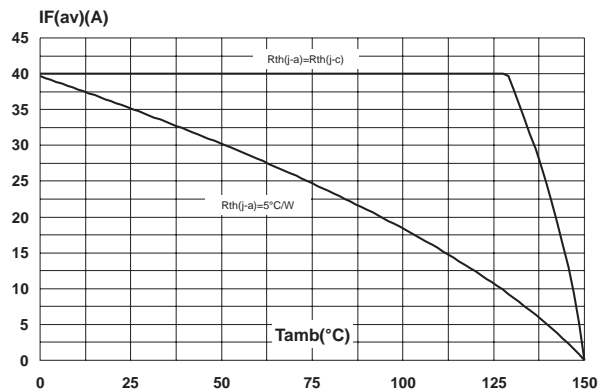

Fig. 4: Normalized avalanche power derating versus junction temperature.

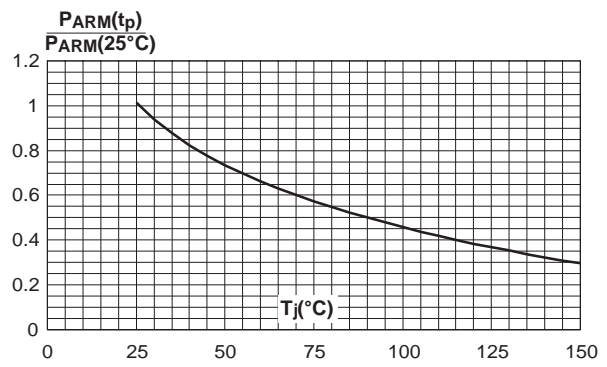

Fig. 5: Non repetitive surge peak forward current versus overload duration (maximum values).

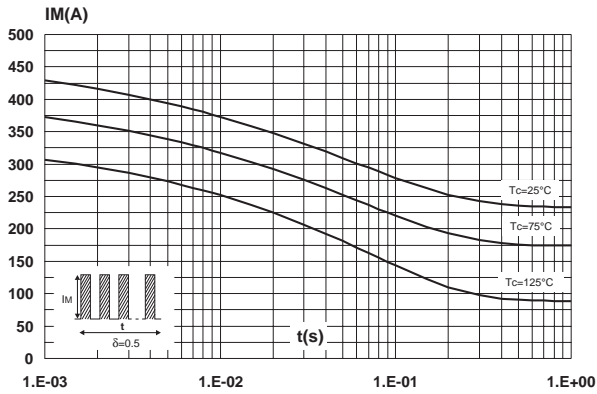

Fig. 6: Relative variation of thermal impedance junction to case versus pulse duration.

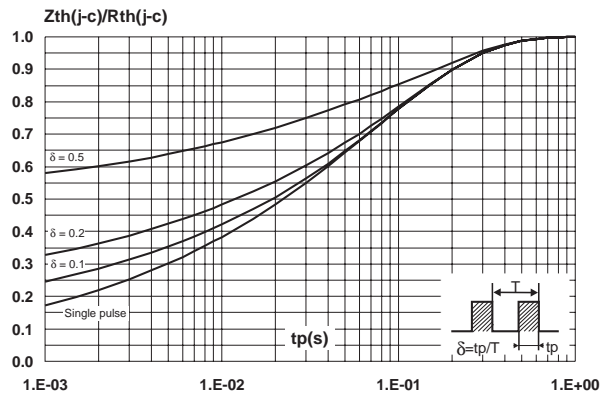

Fig. 7: Reverse leakage current versus reverse voltage applied (typical values).

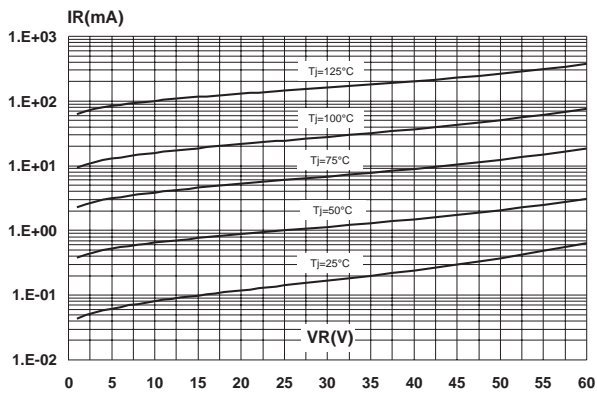

Fig. 8: Junction capacitance versus reverse voltage applied (typical values).

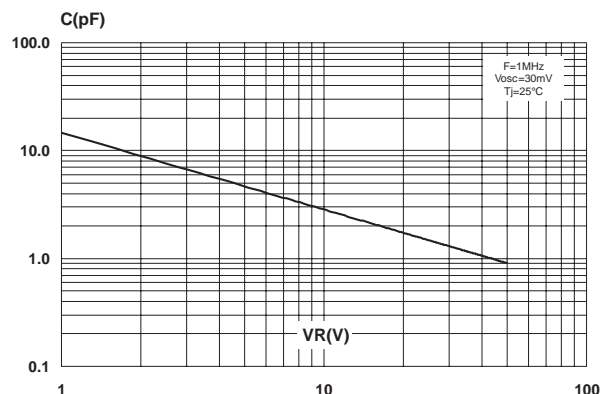
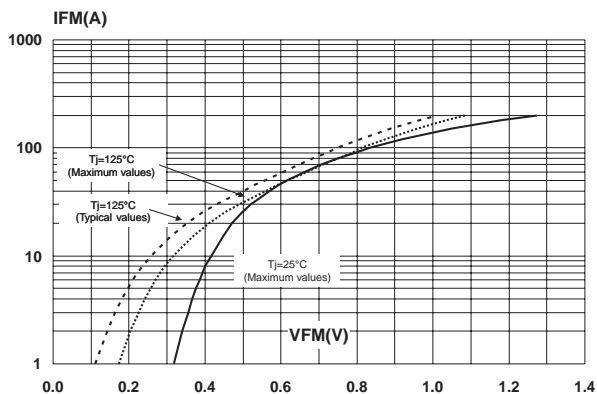

Fig. 9: Forward voltage drop versus forward current.



STPS80L60CY

PACKAGE MECHANICAL DATA

Max247

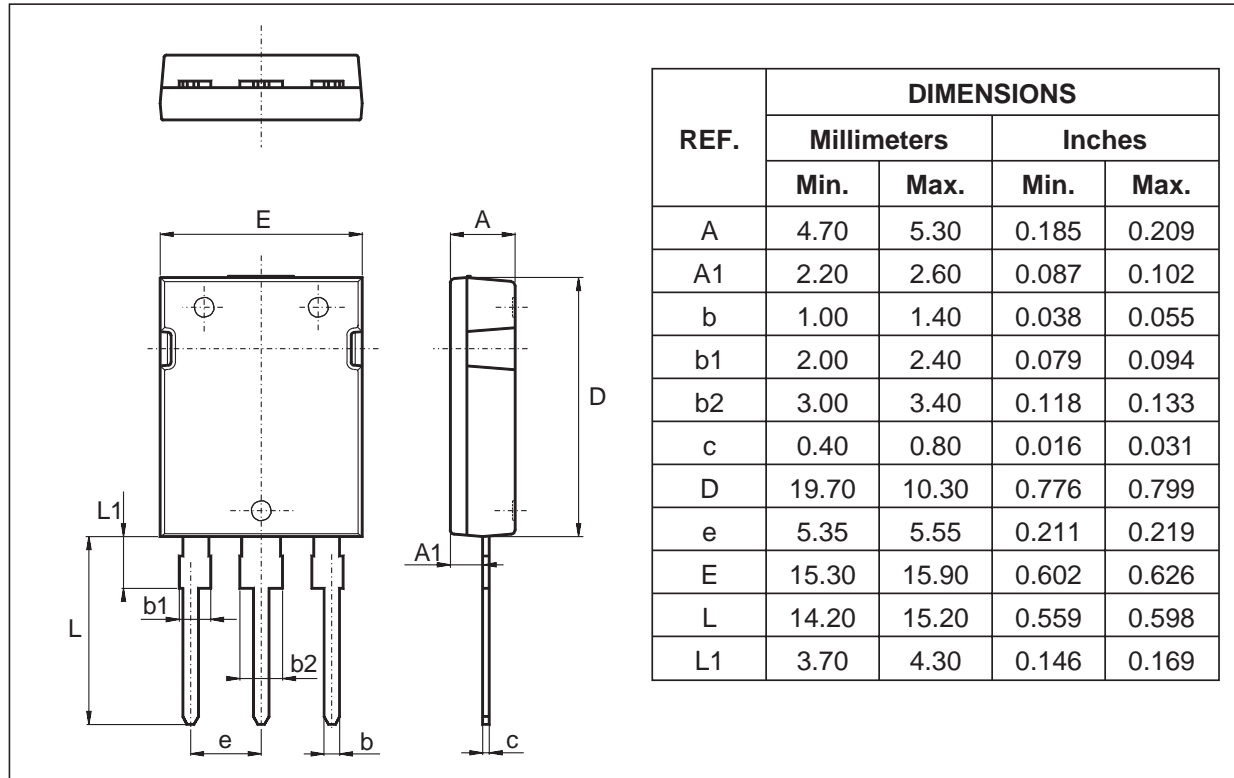

Ordering type	Marking	Package	Weight	Base qty	Delivery mode
STPS80L60CY	STPS80L60CY	Max247	4.4g	30	Tube

- EPOXY MEETS UL94,V0

Information furnished is believed to be accurate and reliable. However, STMicroelectronics assumes no responsibility for the consequences of use of such information nor for any infringement of patents or other rights of third parties which may result from its use. No license is granted by implication or otherwise under any patent or patent rights of STMicroelectronics. Specifications mentioned in this publication are subject to change without notice. This publication supersedes and replaces all information previously supplied. STMicroelectronics products are not authorized for use as critical components in life support devices or systems without express written approval of STMicroelectronics.

The ST logo is a registered trademark of STMicroelectronics
 © 2003 STMicroelectronics - Printed in Italy - All rights reserved.
 STMicroelectronics GROUP OF COMPANIES
 Australia - Brazil - Canada - China - Finland - France - Germany
 Hong Kong - India - Israel - Italy - Japan - Malaysia - Malta - Morocco - Singapore
 Spain - Sweden - Switzerland - United Kingdom - United States.

