

ANGELINA-M-B

~30° medium beam compatible with BJB connectors

TECHNICAL SPECIFICATIONS:

Dimensions	Ø 82.0 mm
Height	31 mm
Fastening	socket
ROHS compliant	yes ⓘ

MATERIAL SPECIFICATIONS:

Component	Type	Material	Colour	Finish	Coating
ANGELINA-M-B	Reflector	PC	metal		HMDS

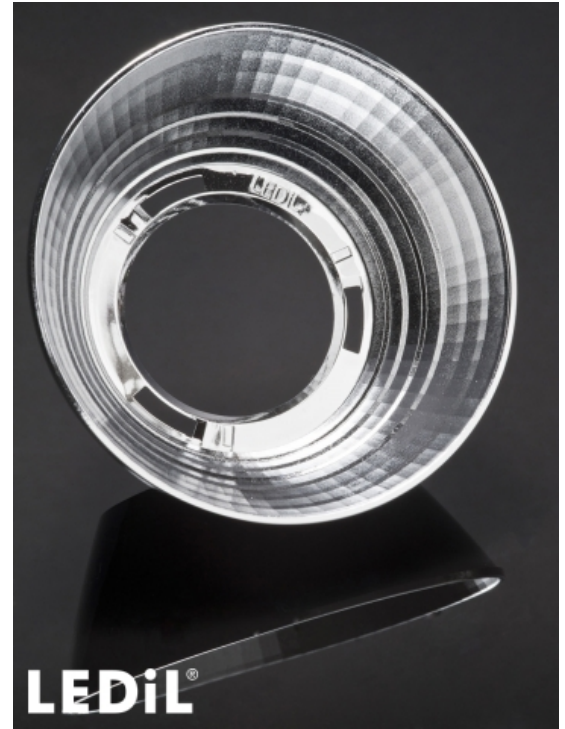

ORDERING INFORMATION:

Component	Qty in box	MOQ	MPQ	Box weight (kg)
F13660_ANGELINA-M-B » Box size: 480 x 280 x 300 mm	2035	110	55	10.0

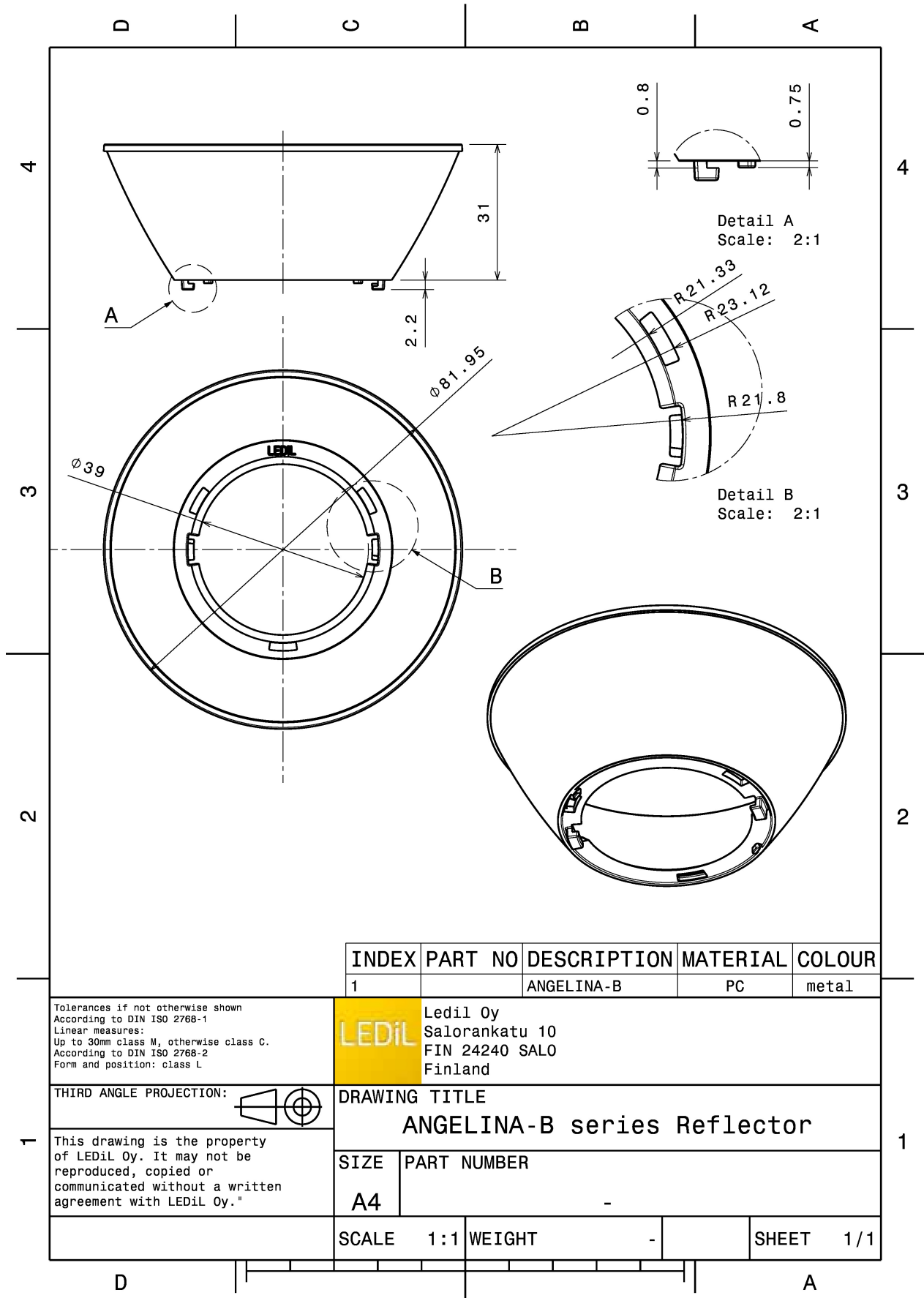

INDEX	PART NO	DESCRIPTION	MATERIAL	COLOUR
1		ANGELINA-B	PC	metal

Tolerances if not otherwise shown
According to DIN ISO 2768-1
Linear measures:
Up to 30mm class M, otherwise class C.
According to DIN ISO 2768-2
Form and position: class L

LEDiL Ledil Oy
Salorankatu 10
FIN 24240 SALO
Finland

THIRD ANGLE PROJECTION:

DRAWING TITLE
ANGELINA-B series Reflector







This drawing is the property of LEDiL Oy. It may not be reproduced, copied or communicated without a written agreement with LEDiL Oy."

SIZE	PART NUMBER
A4	-

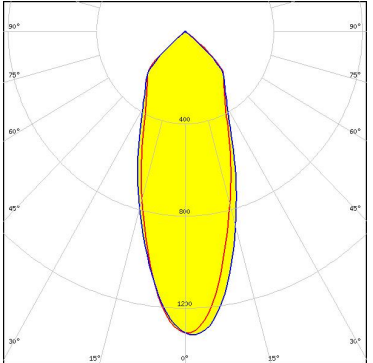

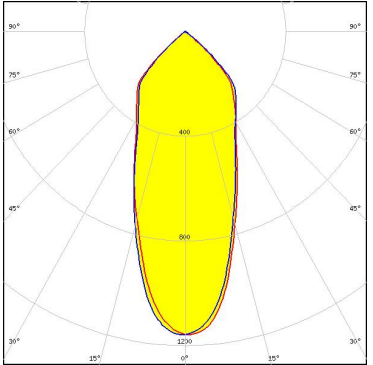

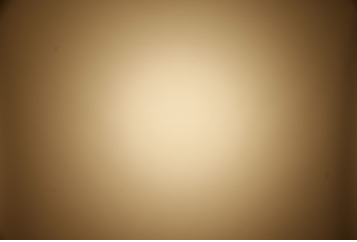
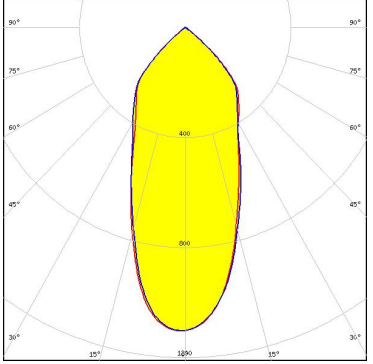

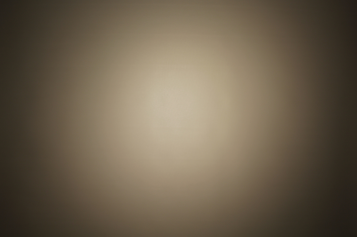
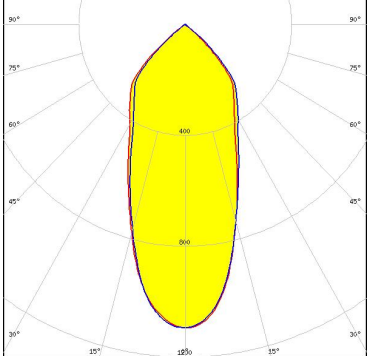
SCALE	1:1	WEIGHT	-	SHEET	1/1
-------	-----	--------	---	-------	-----

See also our general installation guide: www.ledil.com/installation_guide

PHOTOMETRIC DATA (MEASURED):

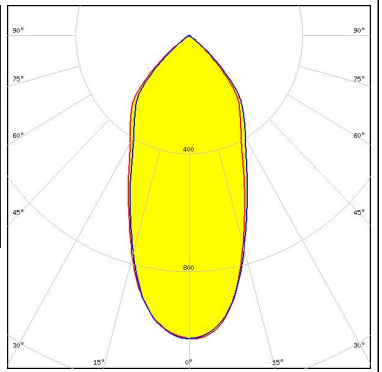
<p></p> <p>LED BXRA ES Rectangle FWHM / FWTM 38.0° / 97.0° Efficiency 92 % Peak intensity 1.3 cd/m LEDs/each optic 1 Light colour White Required components: BJB: 47.319.2040</p>		
<p></p> <p>LED V15 Gen6 FWHM / FWTM 41.0° / 98.0° Efficiency 93 % Peak intensity 1.2 cd/m LEDs/each optic 1 Light colour White Required components: BJB: 47.319.2224</p>		
<p></p> <p>LED V18 Gen6 FWHM / FWTM 44.0° / 98.0° Efficiency 93 % Peak intensity 1.1 cd/m LEDs/each optic 1 Light colour White Required components: BJB: 47.319.2274</p>		
<p></p> <p>LED V18 Gen7 FWHM / FWTM 44.0° / 99.0° Efficiency 93 % Peak intensity 1.1 cd/m LEDs/each optic 1 Light colour White Required components: BJB: 47.319.2350</p>		

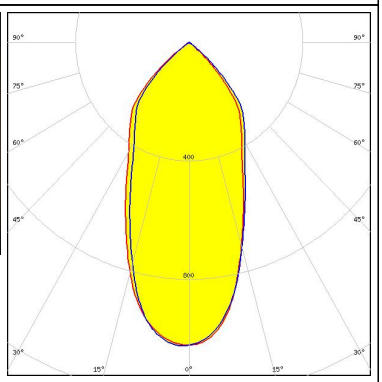
PHOTOMETRIC DATA (MEASURED):

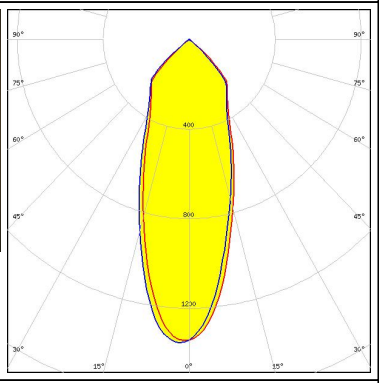
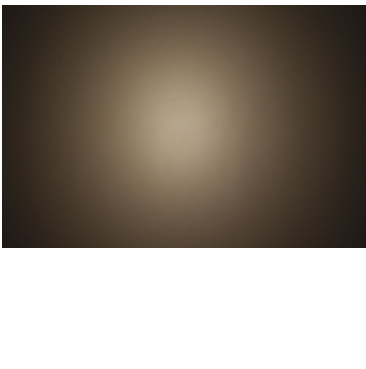
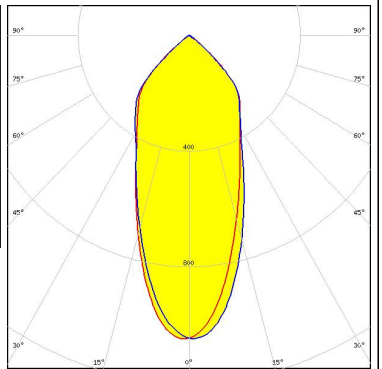
<p></p> <p>LED V22 Gen6 FWHM / FWTM 47.0° / 98.0° Efficiency 91 % Peak intensity 1 cd/lm LEDs/each optic 1 Light colour White Required components: A.A.G. STUCCHI: 8102/G2</p>		
<p></p> <p>LED V22 Gen7 FWHM / FWTM 47.0° / 98.0° Efficiency 91 % Peak intensity 1 cd/lm LEDs/each optic 1 Light colour White Required components: BJB: 47.319.2030</p>		
<p>CITIZEN</p> <p>LED CLL03x/CLU03x FWHM / FWTM 37.0° / 96.0° Efficiency 92 % Peak intensity 1.4 cd/lm LEDs/each optic 1 Light colour White Required components: BJB: 47.319.2021</p>		
<p>CITIZEN</p> <p>LED CLL03x/CLU03x FWHM / FWTM 43.0° / 99.0° Efficiency 89 % Peak intensity 1.1 cd/lm LEDs/each optic 1 Light colour White Required components: F13671_ANGE-RZ-LENS A.A.G. STUCCHI: 8101/G2</p>		

PHOTOMETRIC DATA (MEASURED):

CITIZEN

LED CLL03x/CLU03x
 FWHM / FWTM 39.0° / 98.0°
 Efficiency 94 %
 Peak intensity 1.2 cd/lm
 LEDs/each optic 1
 Light colour White
 Required components:
 A.A.G. STUCCHI: 8101/G2

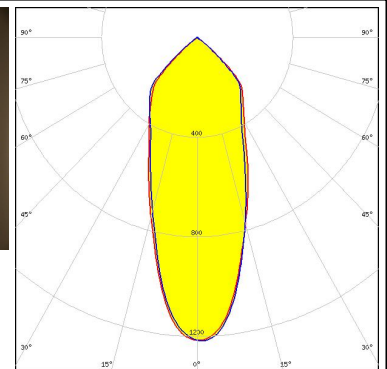
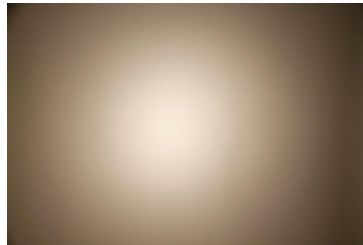

CITIZEN

LED CLL04x/CLU04x
 FWHM / FWTM 50.0° / 101.0°
 Efficiency 87 %
 Peak intensity 0.9 cd/lm
 LEDs/each optic 1
 Light colour White
 Required components:
 F13671_ANGE-RZ-LENS
 A.A.G. STUCCHI: 8102/G2

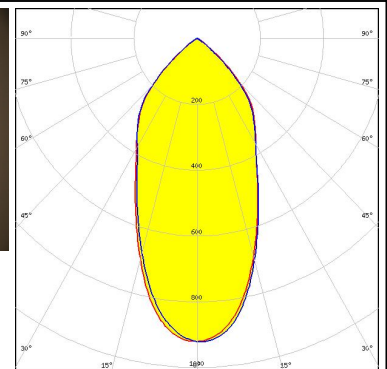
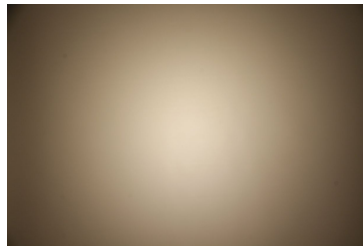

CITIZEN

LED CLL04x/CLU04x
 FWHM / FWTM 39.0° / 98.0°
 Efficiency 94 %
 Peak intensity 1.2 cd/lm
 LEDs/each optic 1
 Light colour White
 Required components:
 A.A.G. STUCCHI: 8102/G2

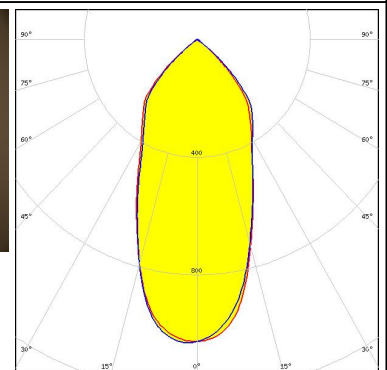
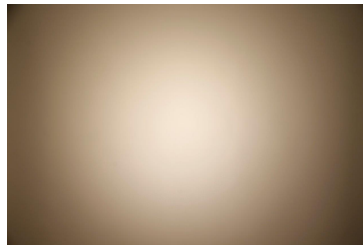

CITIZEN

LED CLU720/721
 FWHM / FWTM 34.0° / 96.0°
 Efficiency 94 %
 Peak intensity 1.4 cd/lm
 LEDs/each optic 1
 Light colour White
 Required components:
 BJB: 47.319.2021

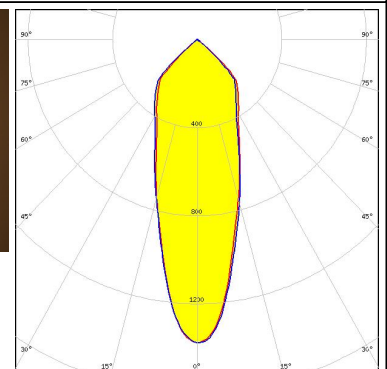
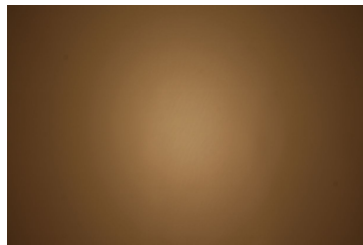

PHOTOMETRIC DATA (MEASURED):

CITIZEN

LED CLU720/721
 FWHM / FWTM 35.0° / 97.0°
 Efficiency 94 %
 Peak intensity 1.3 cd/lm
 LEDs/each optic 1
 Light colour White
 Required components:
 A.A.G. STUCCHI: 8101/G2

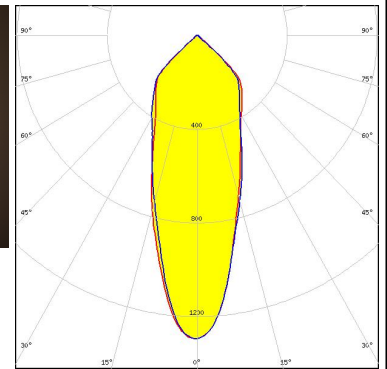
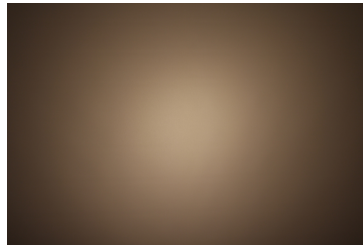

CREE

LED CXA/B 25xx
 FWHM / FWTM 44.0° / 98.0°
 Efficiency 92 %
 Peak intensity 1.1 cd/lm
 LEDs/each optic 1
 Light colour White
 Required components:
 BJB: 47.319.2141

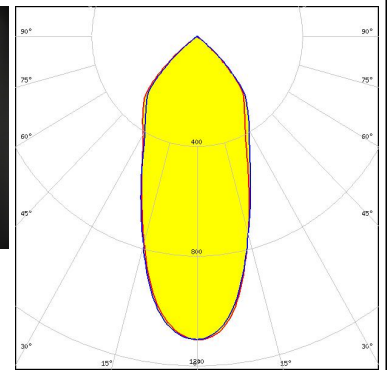
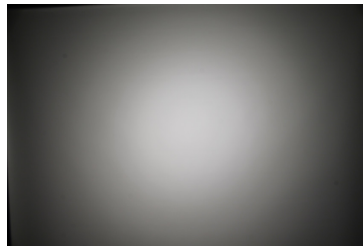

CREE

LED CXA/B 25xx
 FWHM / FWTM 46.0° / 99.0°
 Efficiency 89 %
 Peak intensity 1 cd/lm
 LEDs/each optic 1
 Light colour White
 Required components:
 F13671_ANGE-RZ-LENS
 BJB: 47.319.2141

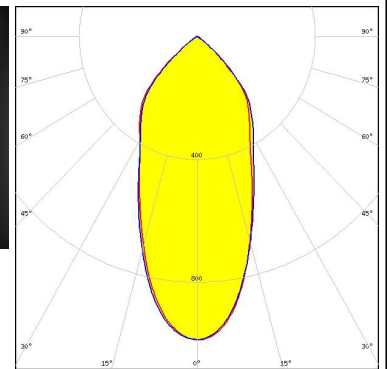
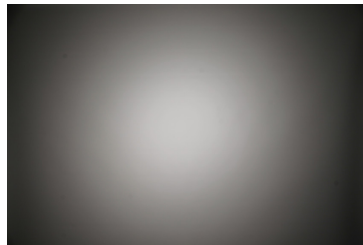





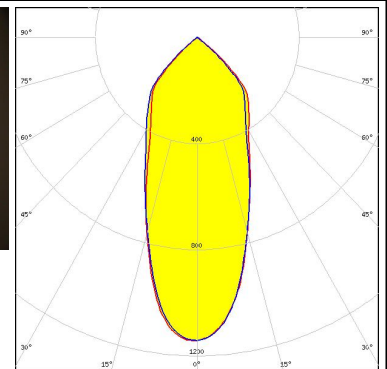
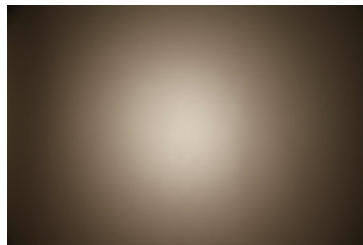



CREE

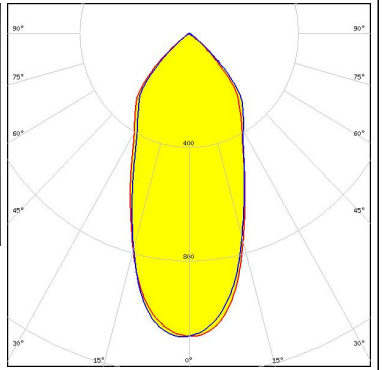

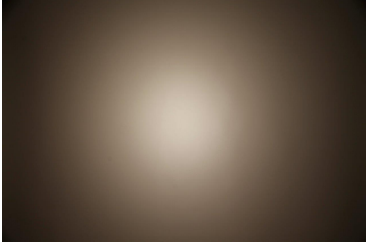
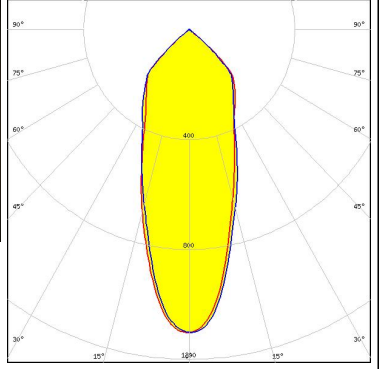
LED CXA/B 25xx
 FWHM / FWTM 42.0° / 98.0°
 Efficiency 93 %
 Peak intensity 1.1 cd/lm
 LEDs/each optic 1
 Light colour White
 Required components:
 A.A.G. STUCCHI: 8401/G2

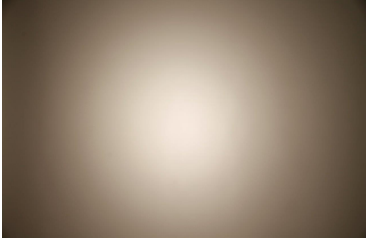
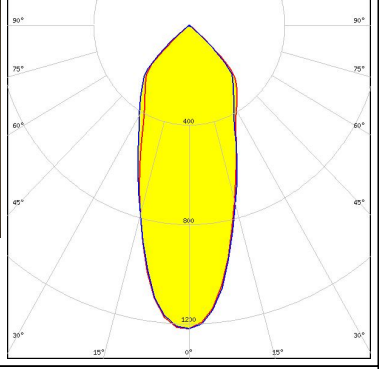

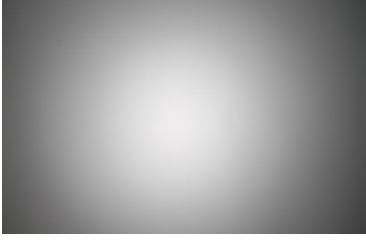
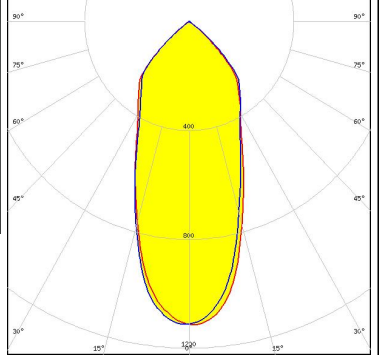

PHOTOMETRIC DATA (MEASURED):

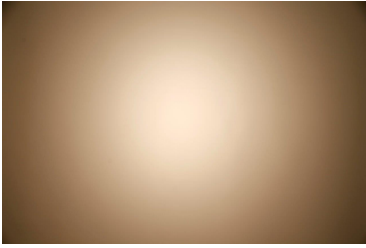
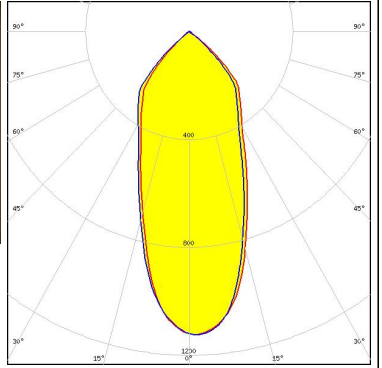
<p>CREE </p> <p>LED CXA/B 30xx FWHM / FWTM 45.0° / 98.0° Efficiency 92 % Peak intensity 1.1 cd/lm LEDs/each optic 1 Light colour White Required components: A.A.G. STUCCHI: 8404/G2</p>		
<p>LUMILEDS </p> <p>LED LUXEON CoB 1204/1205 FWHM / FWTM 38.0° / 97.0° Efficiency 94 % Peak intensity 1.3 cd/lm LEDs/each optic 1 Light colour White Required components: A.A.G. STUCCHI: 8301/G2</p>		
<p>LUMILEDS </p> <p>LED LUXEON CoB 1208 FWHM / FWTM 39.0° / 97.0° Efficiency 94 % Peak intensity 1.2 cd/lm LEDs/each optic 1 Light colour White Required components: A.A.G. STUCCHI: 8301/G2</p>		
<p>LUMILEDS </p> <p>LED LUXEON CoB 1211 FWHM / FWTM 44.0° / 98.0° Efficiency 92 % Peak intensity 1.1 cd/lm LEDs/each optic 1 Light colour White Required components: BJB: 47.319.2030</p>		

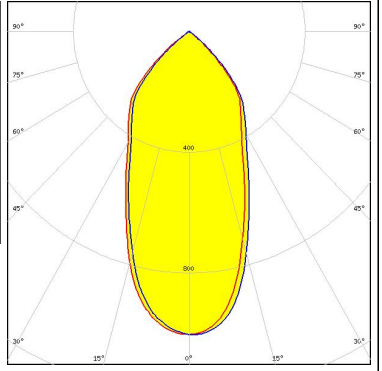
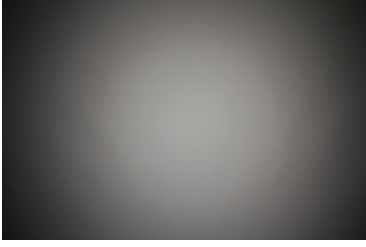
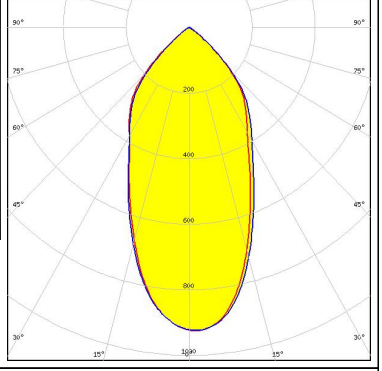
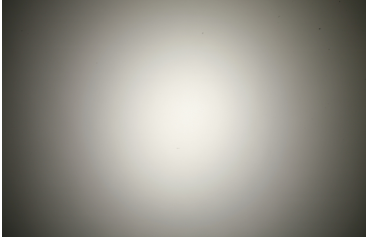
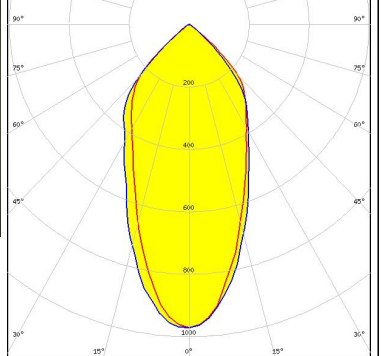
PHOTOMETRIC DATA (MEASURED):

<p>LUMILEDS</p> <p>LED LUXEON CoB 1211</p> <p>FWHM / FWTM 43.0° / 97.0°</p> <p>Efficiency 92 %</p> <p>Peak intensity 1.1 cd/lm</p> <p>LEDs/each optic 1</p> <p>Light colour White</p> <p>Required components: A.A.G. STUCCHI: 8102/G2</p>		
<p>LUMILEDS</p> <p>LED LUXEON CoB 1216/1812</p> <p>FWHM / FWTM 49.0° / 99.0°</p> <p>Efficiency 91 %</p> <p>Peak intensity 1 cd/lm</p> <p>LEDs/each optic 1</p> <p>Light colour White</p> <p>Required components: BJB: 47.319.2030</p>		
<p>LUMILEDS</p> <p>LED LUXEON CoB 1216/1812</p> <p>FWHM / FWTM 50.0° / 100.0°</p> <p>Efficiency 88 %</p> <p>Peak intensity 0.9 cd/lm</p> <p>LEDs/each optic 1</p> <p>Light colour White</p> <p>Required components: F13671_ANGE-RZ-LENS BJB: 47.319.2030</p>		
<p>LUMILEDS</p> <p>LED LUXEON K12</p> <p>FWHM / FWTM 48.0° / 101.0°</p> <p>Efficiency 89 %</p> <p>Peak intensity 1 cd/lm</p> <p>LEDs/each optic 1</p> <p>Light colour White</p> <p>Required components: F13671_ANGE-RZ-LENS BJB: 47.319.2070</p>		

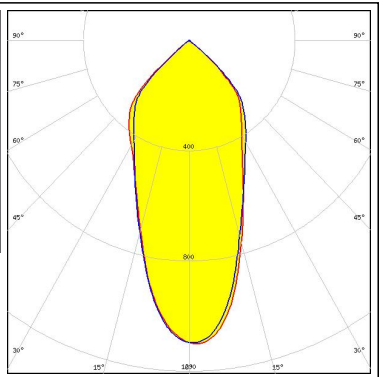
PHOTOMETRIC DATA (MEASURED):

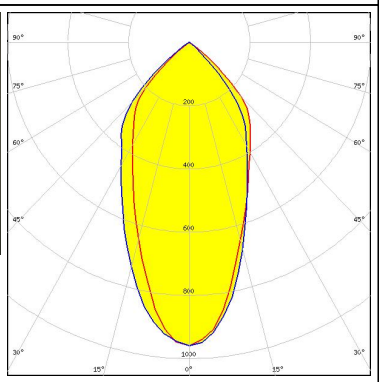
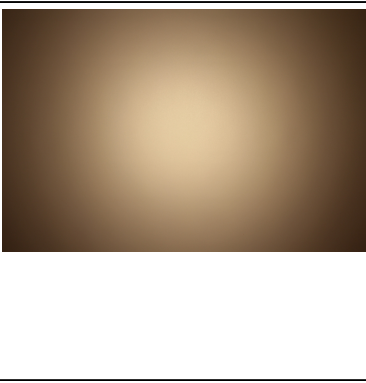
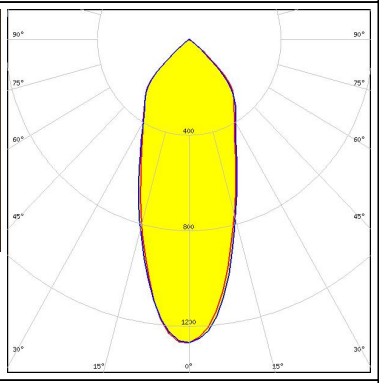
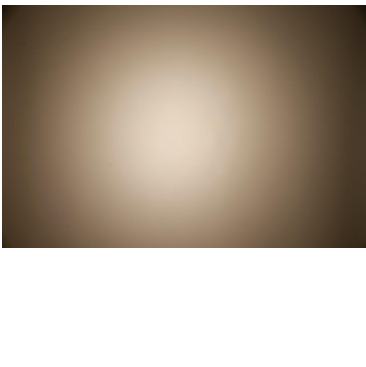
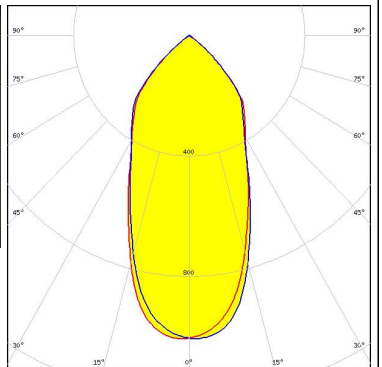
<p>LUMILEDS</p> <p>LED LUXEON K16</p> <p>FWHM / FWTM 44.0° / 98.0°</p> <p>Efficiency 94 %</p> <p>Peak intensity 1.1 cd/lm</p> <p>LEDs/each optic 1</p> <p>Light colour White</p> <p>Required components: BJB: 47.319.2070</p>		
<p>LUMILEDS</p> <p>LED LUXEON K16</p> <p>FWHM / FWTM 50.0° / 101.0°</p> <p>Efficiency 89 %</p> <p>Peak intensity 1 cd/lm</p> <p>LEDs/each optic 1</p> <p>Light colour White</p> <p>Required components: F13671_ANGE-RZ-LENS BJB: 47.319.2070</p>		
<p>LUMINUS</p> <p>LED CxM-14 (19x19)</p> <p>FWHM / FWTM 40.0° / 98.0°</p> <p>Efficiency 94 %</p> <p>Peak intensity 1.3 cd/lm</p> <p>LEDs/each optic 1</p> <p>Light colour White</p> <p>Required components: BJB: 47.319.2021</p>		
<p>LUMINUS</p> <p>LED CxM-22 (28x28)</p> <p>FWHM / FWTM 48.0° / 99.0°</p> <p>Efficiency 92 %</p> <p>Peak intensity 1 cd/lm</p> <p>LEDs/each optic 1</p> <p>Light colour White</p> <p>Required components: BJB: 47.319.2030</p>		

PHOTOMETRIC DATA (MEASURED):

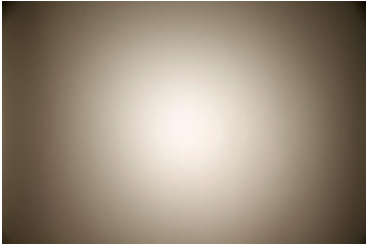
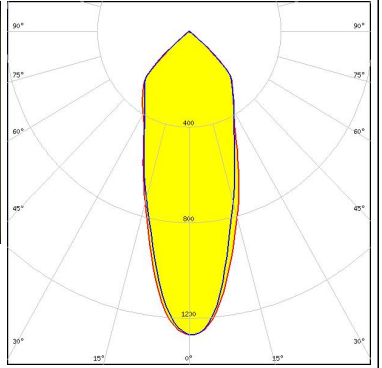
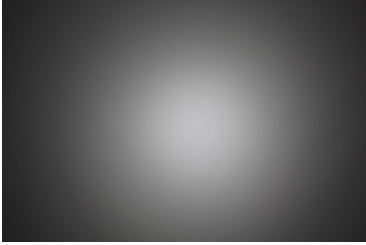
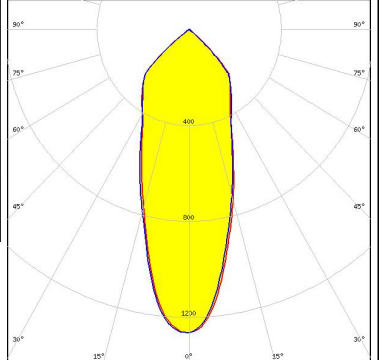
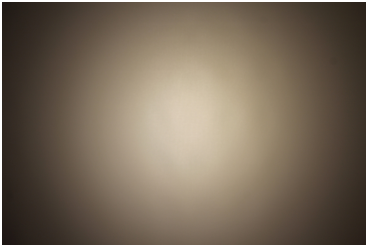
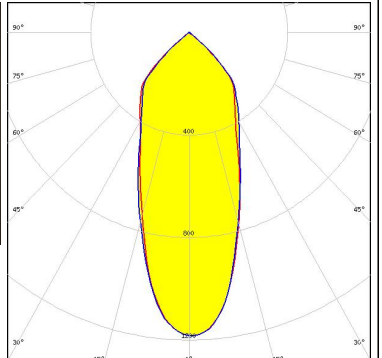
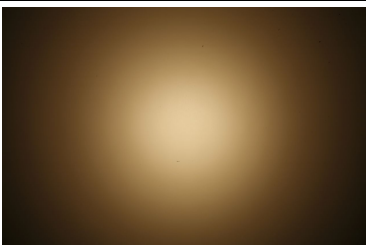
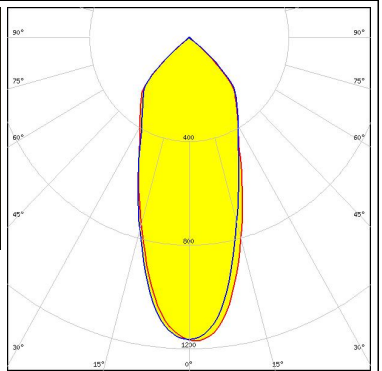
<p>OSRAM Opto Semiconductors</p> <p>LED Soleriq S13</p> <p>FWHM / FWTM 37.0° / 98.0°</p> <p>Efficiency 94 %</p> <p>Peak intensity 1.3 cd/m</p> <p>LEDs/each optic 1</p> <p>Light colour White</p> <p>Required components: A.A.G. STUCCHI: 8502/G2</p>		
<p>OSRAM Opto Semiconductors</p> <p>LED Soleriq S13 19x19</p> <p>FWHM / FWTM 37.0° / 97.0°</p> <p>Efficiency 93 %</p> <p>Peak intensity 0.9 cd/m</p> <p>LEDs/each optic 1</p> <p>Light colour White</p> <p>Required components: BJB: 47.319.2021</p>		
<p>OSRAM Opto Semiconductors</p> <p>LED Soleriq S19</p> <p>FWHM / FWTM 41.0° / 97.0°</p> <p>Efficiency 93 %</p> <p>Peak intensity 1.2 cd/m</p> <p>LEDs/each optic 1</p> <p>Light colour White</p> <p>Required components: A.A.G. STUCCHI: 8503/G2</p>		
<p>OSRAM Opto Semiconductors</p> <p>LED Soleriq S19</p> <p>FWHM / FWTM 41.0° / 98.0°</p> <p>Efficiency 94 %</p> <p>Peak intensity 1.2 cd/m</p> <p>LEDs/each optic 1</p> <p>Light colour White</p> <p>Required components: BJB: 47.319.2170</p>		

PHOTOMETRIC DATA (MEASURED):

PHILIPS

LED Fortimo SLM L19 CoB
 FWHM / FWTM 42.0° / 98.0°
 Efficiency 88 %
 Peak intensity 1.1 cd/lm
 LEDs/each optic 1
 Light colour White
 Required components:
 F13671_ANGE-RZ-LENS
 BJB: 47.319.2030

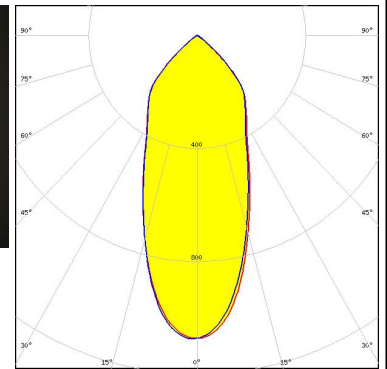
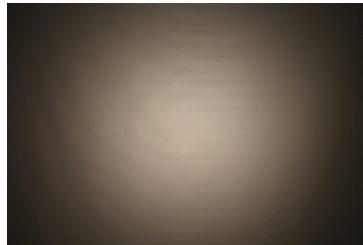

PHILIPS

LED Fortimo SLM L19 CoB
 FWHM / FWTM 40.0° / 97.0°
 Efficiency 93 %
 Peak intensity 1.2 cd/lm
 LEDs/each optic 1
 Light colour White
 Required components:
 BJB: 47.319.2030

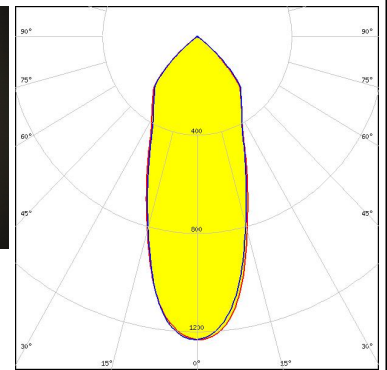
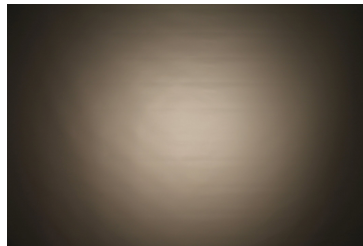

PHILIPS

LED Fortimo SLM L23 CoB
 FWHM / FWTM 44.0° / 98.0°
 Efficiency 93 %
 Peak intensity 1.1 cd/lm
 LEDs/each optic 1
 Light colour White
 Required components:
 BJB: 47.319.2030

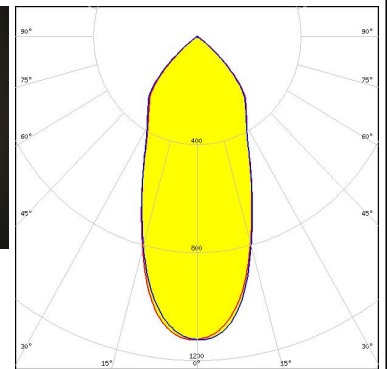
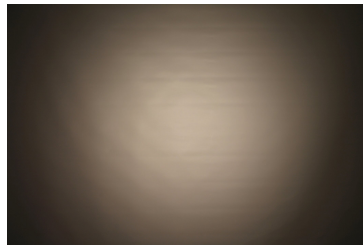

PHILIPS

LED Fortimo SLM L23 CoB
 FWHM / FWTM 45.0° / 99.0°
 Efficiency 88 %
 Peak intensity 1 cd/lm
 LEDs/each optic 1
 Light colour White
 Required components:
 F13671_ANGE-RZ-LENS
 BJB: 47.319.2030

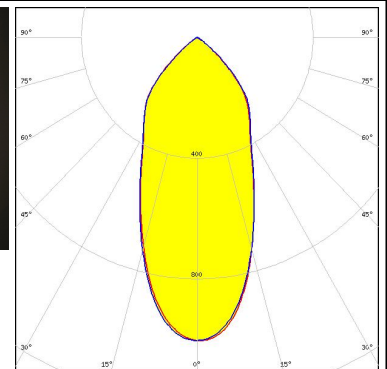
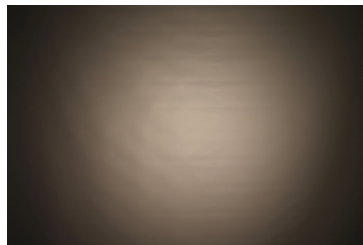

PHOTOMETRIC DATA (MEASURED):

SAMSUNG

LED LC016D / LC019D / LC026D / LC033D
 FWHM / FWTM 41.0° / 98.0°
 Efficiency 93 %
 Peak intensity 1.2 cd/lm
 LEDs/each optic 1
 Light colour White
 Required components:
 A.A.G. STUCCHI: 8101/G2

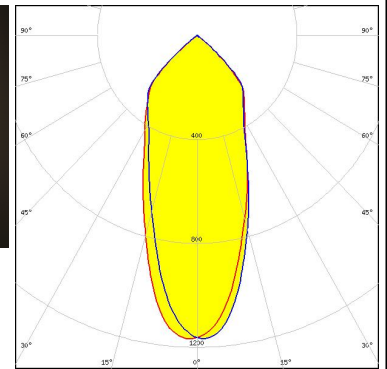
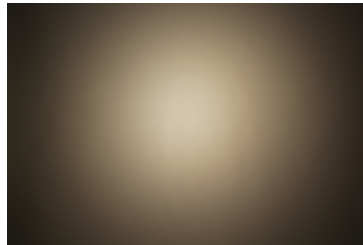

SAMSUNG

LED LC016D / LC019D / LC026D / LC033D
 FWHM / FWTM 45.0° / 100.0°
 Efficiency 89 %
 Peak intensity 1 cd/lm
 LEDs/each optic 1
 Light colour White
 Required components:
 F13671_ANGE-RZ-LENS
 BJB: 47.319.2021

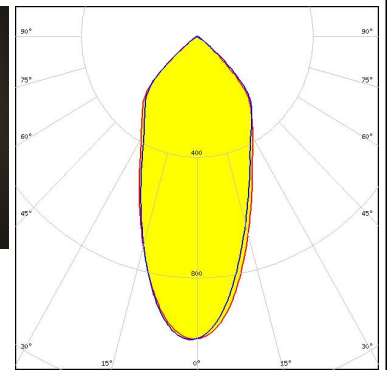
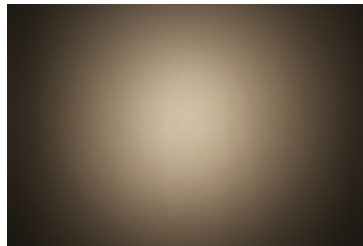

SAMSUNG

LED LC016D / LC019D / LC026D / LC033D
 FWHM / FWTM 45.0° / 100.0°
 Efficiency 89 %
 Peak intensity 1 cd/lm
 LEDs/each optic 1
 Light colour White
 Required components:
 F13671_ANGE-RZ-LENS
 A.A.G. STUCCHI: 8101/G2

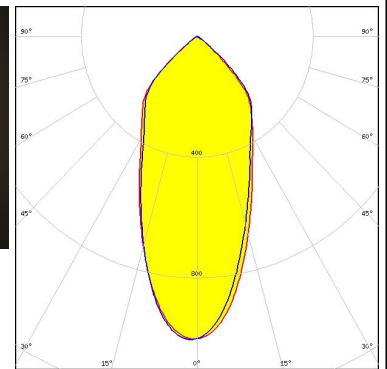
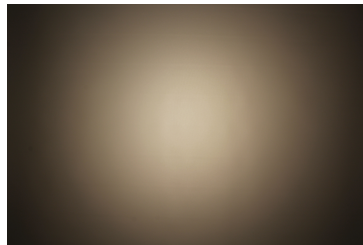

SAMSUNG

LED LC016D / LC019D / LC026D / LC033D
 FWHM / FWTM 41.0° / 98.0°
 Efficiency 93 %
 Peak intensity 1.2 cd/lm
 LEDs/each optic 1
 Light colour White
 Required components:
 BJB: 47.319.2021

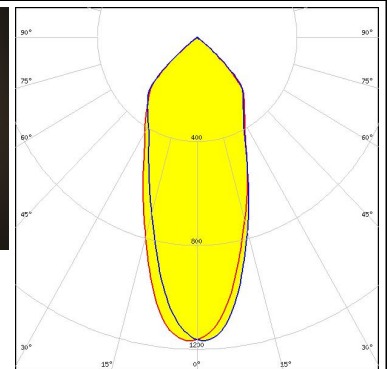
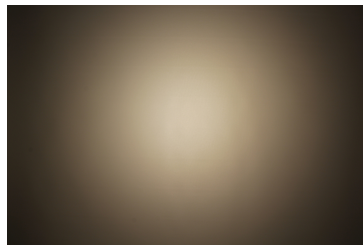

PHOTOMETRIC DATA (MEASURED):

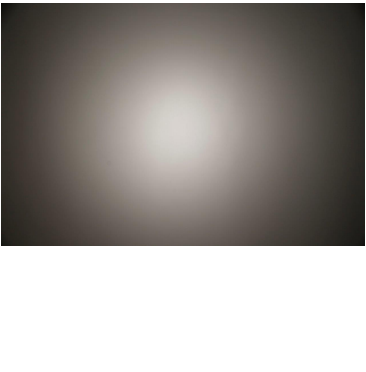
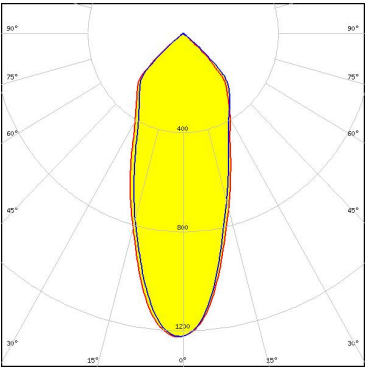
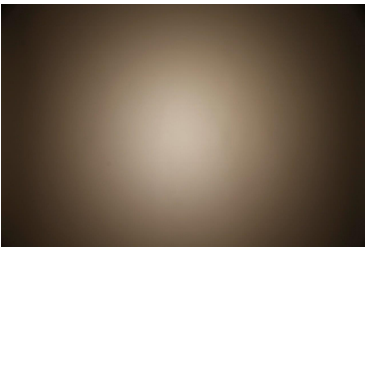
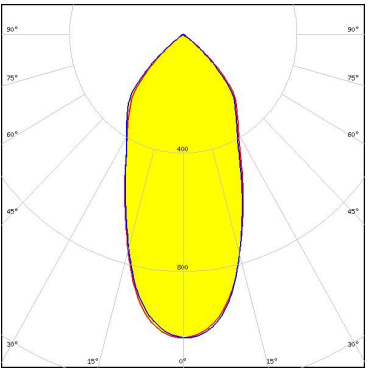
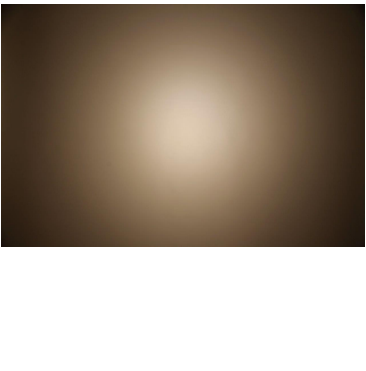
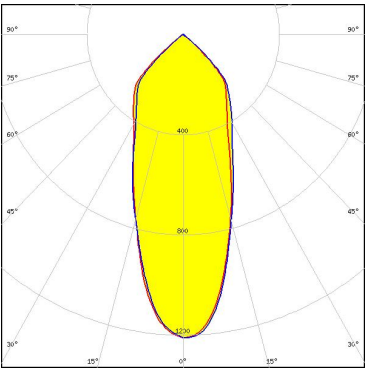
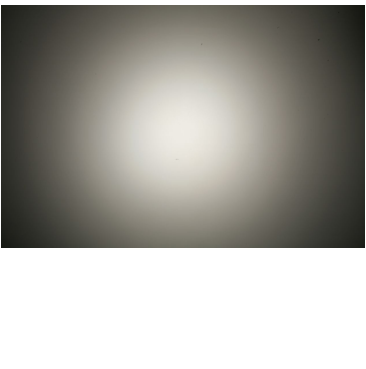
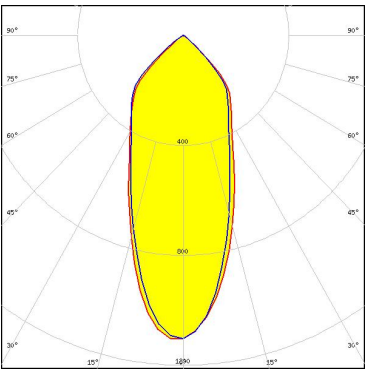
<p>SEOL SEOL SEMICONDUCTOR</p> <p>LED ZC12/18 FWHM / FWTM 39.0° / 97.0° Efficiency 93 % Peak intensity 1.2 cd/lm LEDs/each optic 1 Light colour White Required components: A.A.G. STUCCHI: 8101/G2</p>		
<p>SEOL SEOL SEMICONDUCTOR</p> <p>LED ZC25/40/60 FWHM / FWTM 47.0° / 99.0° Efficiency 92 % Peak intensity 1 cd/lm LEDs/each optic 1 Light colour White Required components: A.A.G. STUCCHI: 8102/G2</p>		
<p>SHARP</p> <p>LED Mega Zenigata (GW6DME) FWHM / FWTM 40.0° / 98.0° Efficiency 94 % Peak intensity 1.2 cd/lm LEDs/each optic 1 Light colour White Required components: A.A.G. STUCCHI: 8301/G2</p>		
<p>SHARP</p> <p>LED Tiger Zenigata (GWTGCBG4FD) FWHM / FWTM 41.0° / 99.0° Efficiency 90 % Peak intensity 1.1 cd/lm LEDs/each optic 1 Light colour White Required components: F13671_ANGE-RZ-LENS BJB: 47.319.2051</p>		

PHOTOMETRIC DATA (MEASURED):

TRIDONIC

LED SLE G7 LES17 H
 FWHM / FWTM 38.0° / 96.0°
 Efficiency 91 %
 Peak intensity 1.2 cd/lm
 LEDs/each optic 1
 Light colour White
 Required components:

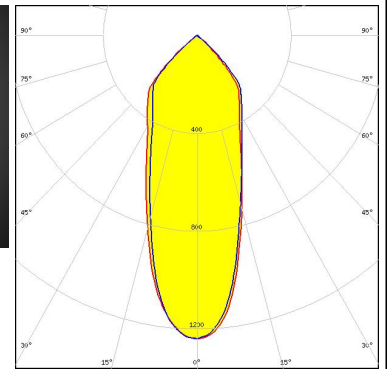
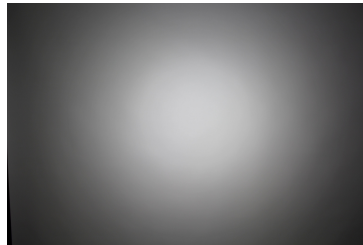

TRIDONIC

LED SLE G7 LES21 H
 FWHM / FWTM 43.0° / 97.0°
 Efficiency 91 %
 Peak intensity 1.1 cd/lm
 LEDs/each optic 1
 Light colour White
 Required components:

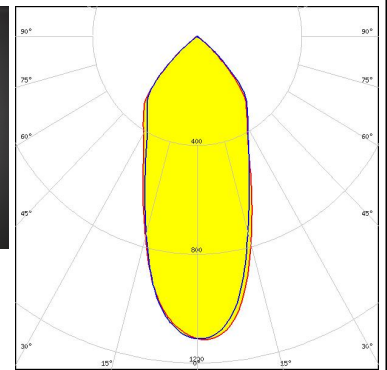
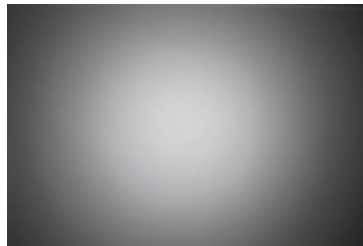

XICATO

LED XOB 14.5 mm
 FWHM / FWTM 40.0° / 98.0°
 Efficiency 94 %
 Peak intensity 1.2 cd/lm
 LEDs/each optic 1
 Light colour White
 Required components:
 BJB: 47.319.2021

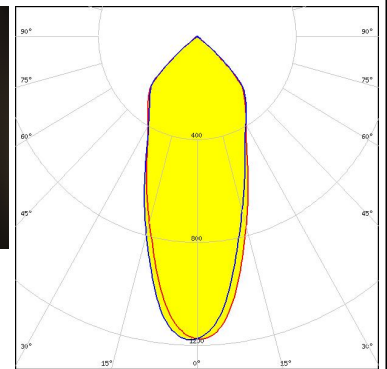
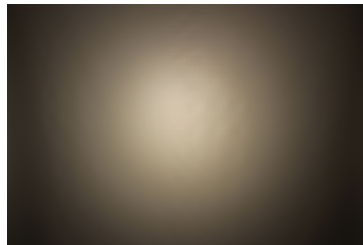

XICATO

LED XTM - 19mm LES
 FWHM / FWTM 43.0° / 98.0°
 Efficiency 93 %
 Peak intensity 1.1 cd/lm
 LEDs/each optic 1
 Light colour White
 Required components:
 C15743_XTM-ADAPTER-50-B

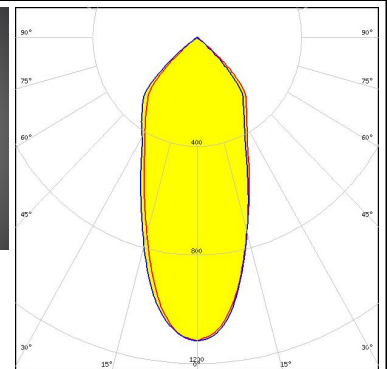

PHOTOMETRIC DATA (SIMULATED):

CITIZEN

LED CLL04x/CLU04x
FWHM / FWTM 37.0° / 90.0°
Efficiency 95 %
Peak intensity 1.6 cd/lm
LEDs/each optic 1
Light colour White
Required components:
BJB: 47.319.2030

CITIZEN

LED CLU730/731
FWHM / FWTM 37.0° / 93.0°
Efficiency 91 %
Peak intensity 1.6 cd/lm
LEDs/each optic 1
Light colour White
Required components:
BJB: 47.319.2030

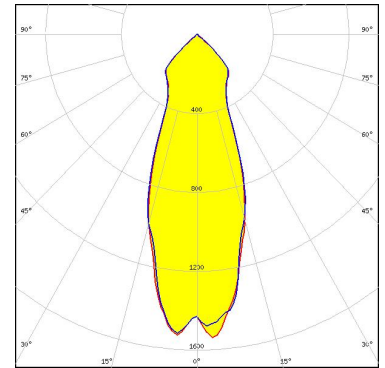

SAMSUNG

LED LC040D / LC060D / LC080D
FWHM / FWTM 41.0° / 94.0°
Efficiency 90 %
Peak intensity 1.3 cd/lm
LEDs/each optic 1
Light colour White
Required components:
BJB: 47.319.2030

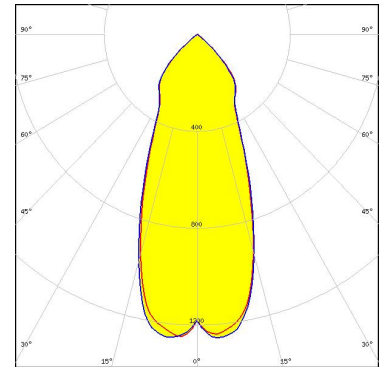

GENERAL INFORMATION:

NOTE: The typical beam angle will be changed by different color, chip size and chip position tolerance. The typical total beam angle is the full angle measured where the luminous intensity is half of the peak value.

Due to use of high power COB's with this product, special attention to proper thermal design is highly recommended. LEDiL has no liability for direct, indirect or consecutive damages arising from the LEDiL products being used outside of the recommended temperature range.

MATERIALS:

As part of our continuous research and improvement processes, and to ensure the best possible quality and availability of our products, LEDiL reserves the right to change material grades without notice.

PRODUCT DATA USER AGREEMENT AND DISCLAIMER:

The measured data in the provided downloadable LEDiL Product Datasheets and Mechanical 2D-Drawings is rounded and provided as reference for planning. LEDiL Oy's optical specifications have been verified by conducting performance testing of the products in accordance with the company's quality system. The reported data are averaged results of multiple measurements with typical variation. LEDiL Oy reserves the right to without prior notification make changes and improvements to its products.

LEDiL Oy assumes neither warranty, nor guarantee nor any other liability of any kind for the contents and correctness of the provided data. The provided data has been generated with highest diligence but the provided data may in reality not represent the complete possible variation range of all intrinsic parameters. Therefore, in certain cases a deviation from the provided data could occur.

LEDiL Oy reserves the right to undertake technical changes of its products without further notification which could lead to changes in the provided data. LEDiL Oy assumes no liability of any kind for the possible deviation from any provided data or any other damage resulting from the usage of the provided data.

The user agrees to this disclaimer and user agreement with the download or usage of the provided files.

LEDiL Oy

Joensuunkatu 13
FI-24240 SALO
Finland

LEDiL Inc.

228 West Page Street
Suite D
Sycamore IL 60178
USA

Ledil Optics Technology (Shenzhen) Co., Ltd.

405 , Block B
Casic Motor Building
Shenzhen 518057
P.R.CHINA

Local sales and technical support

[www.ledil.com/
where_to_buy](http://www.ledil.com/where_to_buy)

Shipping locations

Salo, Finland
Hong Kong, China

Distribution Partners

[www.ledil.com/
where_to_buy](http://www.ledil.com/where_to_buy)