

THIS DOCUMENT IS THE PROPERTY OF
KEYSTONE ELECTRONICS CORP. AND
SHALL NOT BE REPRODUCED, DISTRIBUTED
OR USED AS A BASIS FOR MANUFACTURE
WITHOUT PRIOR WRITTEN PERMISSION
FROM KEYSTONE ELECTRONICS CORP.

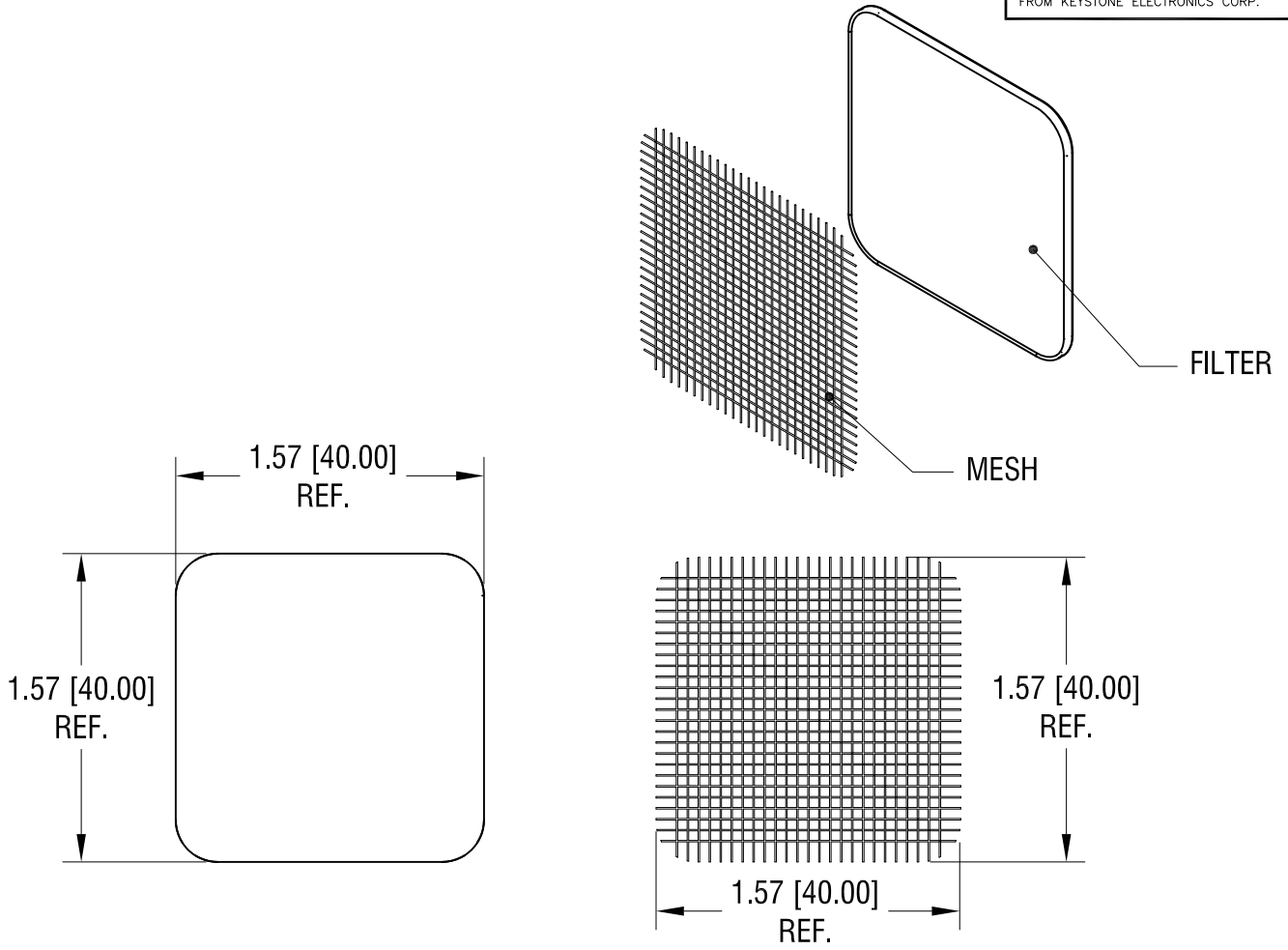

NOTE:

- FILTER INCLUDES: a) MESH (1) ONE PICE: MAT'L- ALUMINUM
 - b) FILTER (1) ONE PICE: MAT'L- POLYESTER
- FILTER SUPPLIED UNASSEMBLED

KEYSTONE ELECTRONICS CORP.			
www.keyelco.com • ASTORIA, N.Y. 11105-2017 • Tel (718) 956-8900			
PART NAME			
FAN FILTER FOR Ø40mm FAN			
MATERIAL			
AS NOTED			
FINISH		DRN BY	DATE
AS NOTED		NT	2.01.13
		APP'D	SCALE
		LN	.7X
TOLERANCES	INCH [MM]	CODE	DWG NO.
DECIMAL	± .010 [± 0.25]	C	8443-M0
ANGULAR	± 1°		
UNLESS OTHERWISE SPECIFIED			

DATE	DESCRIPTION	REV.	
------	-------------	------	--