

**User Manual**

# ARK-3403

*Trusted ePlatform Services*

**ADVANTECH**

---

## Copyright

The documentation and the software included with this product are copyrighted 2010 by Advantech Co., Ltd. All rights are reserved. Advantech Co., Ltd. reserves the right to make improvements in the products described in this manual at any time without notice. No part of this manual may be reproduced, copied, translated or transmitted in any form or by any means without the prior written permission of Advantech Co., Ltd. Information provided in this manual is intended to be accurate and reliable. However, Advantech Co., Ltd. assumes no responsibility for its use, nor for any infringements of the rights of third parties, which may result from its use.

## Acknowledgements

Intel and Pentium are trademarks of Intel Corporation.

Microsoft Windows and MS-DOS are registered trademarks of Microsoft Corp.

All other product names or trademarks are properties of their respective owners.

## Product Warranty (2 years)

Advantech warrants to you, the original purchaser, that each of its products will be free from defects in materials and workmanship for two years from the date of purchase.

This warranty does not apply to any products which have been repaired or altered by persons other than repair personnel authorized by Advantech, or which have been subject to misuse, abuse, accident or improper installation. Advantech assumes no liability under the terms of this warranty as a consequence of such events.

Because of Advantech's high quality-control standards and rigorous testing, most of our customers never need to use our repair service. If an Advantech product is defective, it will be repaired or replaced at no charge during the warranty period. For out-of-warranty repairs, you will be billed according to the cost of replacement materials, service time and freight. Please consult your dealer for more details.

If you think you have a defective product, follow these steps:

1. Collect all the information about the problem encountered. (For example, CPU speed, Advantech products used, other hardware and software used, etc.) Note anything abnormal and list any onscreen messages you get when the problem occurs.
2. Call your dealer and describe the problem. Please have your manual, product, and any helpful information readily available.
3. If your product is diagnosed as defective, obtain an RMA (return merchandise authorization) number from your dealer. This allows us to process your return more quickly.
4. Carefully pack the defective product, a fully-completed Repair and Replacement Order Card and a photocopy proof of purchase date (such as your sales receipt) in a shippable container. A product returned without proof of the purchase date is not eligible for warranty service.
5. Write the RMA number visibly on the outside of the package and ship it prepaid to your dealer.

Part No. 2006340301

Printed in China

Edition 2

September 2010

# Declaration of Conformity

## CE

This product has passed the CE test for environmental specifications when shielded cables are used for external wiring. We recommend the use of shielded cables. This kind of cable is available from Advantech. Please contact your local supplier for ordering information.

Also, this product has passed the CE test for environmental specifications. Test conditions for passing included the equipment being operated within an industrial enclosure. In order to protect the product from being damaged by ESD (Electrostatic Discharge) and EMI leakage, we strongly recommend the use of CE-compliant industrial enclosure products.

## FCC Class A

Note: This equipment has been tested and found to comply with the limits for a Class A digital device, pursuant to part 15 of the FCC Rules. These limits are designed to provide reasonable protection against harmful interference when the equipment is operated in a commercial environment. This equipment generates, uses, and can radiate radio frequency energy and, if not installed and used in accordance with the instruction manual, may cause harmful interference to radio communications. Operation of this equipment in a residential area is likely to cause harmful interference in which case the user will be required to correct the interference at his own expense.

## FCC Class B

Note: This equipment has been tested and found to comply with the limits for a Class B digital device, pursuant to part 15 of the FCC Rules. These limits are designed to provide reasonable protection against harmful interference in a residential installation. This equipment generates, uses and can radiate radio frequency energy and, if not installed and used in accordance with the instructions, may cause harmful interference to radio communications. However, there is no guarantee that interference will not occur in a particular installation. If this equipment does cause harmful interference to radio or television reception, which can be determined by turning the equipment off and on, the user is encouraged to try to correct the interference by one or more of the following measures:

- Reorient or relocate the receiving antenna.
- Increase the separation between the equipment and receiver.
- Connect the equipment into an outlet on a circuit different from that to which the receiver is connected.
- Consult the dealer or an experienced radio/TV technician for help.

## FM

This equipment has passed the FM certification. According to the National Fire Protection Association, work sites are classified into different classes, divisions and groups, based on hazard considerations. This equipment is compliant with the specifications of Class I, Division 2, Groups A, B, C and D indoor hazards.

---

## Technical Support and Assistance

1. Visit the Advantech web site at <http://support.advantech.com.cn> where you can find the latest information about the product.
2. Contact your distributor, sales representative, or Advantech's customer service center for technical support if you need additional assistance. Please have the following information ready before you call:
  - Product name and serial number
  - Description of your peripheral attachments
  - Description of your software (operating system, version, application software, etc.)
  - A complete description of the problem
  - The exact wording of any error messages

## Warnings, Cautions and Notes

**Warning!** *Warnings indicate conditions, which if not observed, can cause personal injury!*



**Caution!** *Cautions are included to help you avoid damaging hardware or losing data. e.g.*



*There is a danger of a new battery exploding if it is incorrectly installed. Do not attempt to recharge, force open, or heat the battery. Replace the battery only with the same or equivalent type recommended by the manufacturer. Discard used batteries according to the manufacturer's instructions.*

**Note!** *Notes provide optional additional information.*



## Document Feedback

To assist us in making improvements to this manual, we would welcome comments and constructive criticism. Please send all such - in writing to: [support@advantech.com.cn](mailto:support@advantech.com.cn)

# Safety Instructions

1. Read these safety instructions carefully.
2. Keep this User Manual for later reference.
3. Disconnect this equipment from any AC outlet before cleaning. Use a damp cloth. Do not use liquid or spray detergents for cleaning.
4. For plug-in equipment, the power outlet socket must be located near the equipment and must be easily accessible.
5. Keep this equipment away from humidity.
6. Put this equipment on a reliable surface during installation. Dropping it or letting it fall may cause damage.
7. The openings on the enclosure are for air convection. Protect the equipment from overheating. **DO NOT COVER THE OPENINGS.**
8. Make sure the voltage of the power source is correct before connecting the equipment to the power outlet.
9. Position the power cord so that people cannot step on it. Do not place anything over the power cord.
10. All cautions and warnings on the equipment should be noted.
11. If the equipment is not used for a long time, disconnect it from the power source to avoid damage by transient overvoltage.
12. Never pour any liquid into an opening. This may cause fire or electrical shock.
13. Never open the equipment. For safety reasons, the equipment should be opened only by qualified service personnel.
14. If one of the following situations arises, get the equipment checked by service personnel:
  - The power cord or plug is damaged.
  - Liquid has penetrated into the equipment.
  - The equipment has been exposed to moisture.
  - The equipment does not work well, or you cannot get it to work according to the user's manual.
  - The equipment has been dropped and damaged.
  - The equipment has obvious signs of breakage.
15. **DO NOT LEAVE THIS EQUIPMENT IN AN ENVIRONMENT WHERE THE STORAGE TEMPERATURE MAY GO BELOW -20° C (-4° F) OR ABOVE 60° C (140° F). THIS COULD DAMAGE THE EQUIPMENT. THE EQUIPMENT SHOULD BE IN A CONTROLLED ENVIRONMENT.**
16. **CAUTION: DANGER OF EXPLOSION IF BATTERY IS INCORRECTLY REPLACED. REPLACE ONLY WITH THE SAME OR EQUIVALENT TYPE RECOMMENDED BY THE MANUFACTURER, DISCARD USED BATTERIES ACCORDING TO THE MANUFACTURER'S INSTRUCTIONS.**

The sound pressure level at the operator's position according to IEC 704-1:1982 is no more than 70 dB (A).

**DISCLAIMER:** This set of instructions is given according to IEC 704-1. Advantech disclaims all responsibility for the accuracy of any statements contained herein.

---

## Safety Precaution - Static Electricity

Follow these simple precautions to protect yourself from harm and the products from damage.

- To avoid electrical shock, always disconnect the power from your PC chassis before you work on it. Don't touch any components on the CPU card or other cards while the PC is on.
- Disconnect power before making any configuration changes. The sudden rush of power as you connect a jumper or install a card may damage sensitive electronic components.

# Contents

<b>Chapter 1</b>	<b>General Introduction .....</b>	<b>1</b>
1.1	Introduction .....	2
1.2	Product Features.....	2
	1.2.1 General .....	2
	1.2.2 Display .....	2
	1.2.3 Power Consumption.....	2
1.3	Hardware Specifications .....	3
1.4	Mechanical Specifications.....	3
	1.4.1 Dimensions .....	3
	Figure 1.1 ARK-3403 Mechanical dimension drawing.....	3
	1.4.2 Weight.....	4
1.5	Power Requirement .....	4
	1.5.1 System Power.....	4
	1.5.2 RTC Battery .....	4
1.6	Environmental Specifications .....	4
	1.6.1 Operation Temperature.....	4
	1.6.2 Relative Humidity .....	4
	1.6.3 Storage Temperature.....	4
	1.6.4 Vibration loading during operation .....	4
	1.6.5 Shock during operation .....	4
	1.6.6 EMC .....	4
	1.6.7 Safety.....	4
<b>Chapter 2</b>	<b>Hardware Installation .....</b>	<b>5</b>
2.1	ARK-3403 I/O indication.....	6
	Figure 2.1 ARK-3403 Front view .....	6
	Figure 2.2 ARK-3403 Rear view .....	6
2.2	ARK-3403 front side external I/O connectors.....	7
	2.2.1 Power ON/OFF Button.....	7
	Figure 2.3 Powers ON/OFF Button.....	7
	2.2.2 Reset Button .....	7
	Figure 2.4 Reset Button.....	7
	2.2.3 LED Indicators .....	7
	Figure 2.5 LED Indicators .....	7
	2.2.4 Audio Connector .....	7
	Figure 2.6 Audio jack connectors .....	7
	2.2.5 COM Connector .....	8
	Figure 2.7 COM port connector .....	8
	Table 2.1: COM standard serial port pin assignments .....	8
	2.2.6 e-SATA Connector.....	8
	Figure 2.8 e-SATA connector .....	8
	2.2.7 USB Connector .....	9
	Figure 2.9 USB connector .....	9
	Table 2.2: USB Connector.....	9
	2.2.8 Compact Flash Card .....	9
2.3	ARK-3403 rear side external I/O connectors .....	9
	2.3.1 Power Input Connector .....	9
	Figure 2.10Power Input Connector.....	9
	Table 2.3: Power connector pin assignments.....	9
	2.3.2 VGA Connector.....	10
	Figure 2.11VGA connector .....	10
	Table 2.4: VGA Connector pin assignments .....	10
	2.3.3 Ethernet Connector (LAN) .....	10

	Figure 2.12RJ-45 Ethernet connector .....	10
	Table 2.5: RJ-45 Connector pin assignments .....	10
2.3.4	LVDS Connector (Optional).....	11
	Figure 2.13LVDS connector .....	11
	Table 2.6: CN35 LVDS Connector Pin Assignment .....	11
2.3.5	LCD backlight On/Off control Connector (Optional).....	12
	Figure 2.14LCD backlight connector .....	12
	Table 2.7: CN34 LCD Backlight Connector Pin Assignment.....	12
2.3.6	LPT Connector (Optional).....	13
	Figure 2.15LPT connector .....	13
	Table 2.8: CN29 LPT Connector Pin Assignment .....	13
2.3.7	DIO Connector (Optional).....	14
	Figure 2.16DIO connector .....	14
	Table 2.9: CN32 DIO Connector Pin Assignment .....	14
2.4	Memory Installation.....	15
	Figure 2.17 Memory installation .....	15
2.5	Compact Flash installation.....	16
	Figure 2.18CF card installation.....	16
2.6	HDD installation .....	16
2.6.1	Internal fixed HDD installation .....	16
	Figure 2.19Internal fixed HDD installation .....	16
2.6.2	Removable HDD installation.....	17
	Figure 2.20Removable HDD installation .....	17
2.7	PCI card installation .....	18
	Figure 2.21Removable PCI Installation .....	18
2.8	Mini PCIe installation .....	19
	Figure 2.22Mini PCIe Card Installation.....	19
2.9	Antenna installation.....	19
	Figure 2.23Antenna installation .....	19

## Chapter 3 BIOS Settings ..... 21

3.1	BIOS Introduction.....	22
	Figure 3.1 Setup program initial screen.....	22
3.2	Entering BIOS Setup.....	22
3.3	Main Setup.....	23
	Figure 3.2 Main setup screen .....	23
3.3.1	System time / System date .....	23
3.4	Advanced BIOS Features Setup.....	24
	Figure 3.3 Advanced BIOS features setup screen .....	24
3.4.1	CPU Configuration.....	24
3.4.2	IDE Configuration .....	25
	Figure 3.4 IDE Configuration .....	25
3.4.3	Super IO Configuration.....	26
	Figure 3.5 Super I/O Configuration.....	26
3.4.4	Hardware Health Configuration .....	27
	Figure 3.6 Hardware Health Configuration .....	27
3.4.5	ACPI Configuration.....	27
	Figure 3.7 ACPI Settings .....	27
	Figure 3.8 General ACPI Configuration.....	28
	Figure 3.9 Advanced ACPI Configuration.....	28
	Figure 3.10Chipset ACPI Configuration .....	29
3.4.6	AHCI Configuration.....	30
	Figure 3.11Advanced ACPI Configuration.....	30
3.4.7	APM Configuration.....	30
	Figure 3.12APM Configuration .....	30
3.4.8	Event Log Configuration .....	31
	Figure 3.13South Bridge ACPI Configuration.....	31
3.4.9	MPS Configuration.....	32



	Figure 3.14 South Bridge ACPI Configuration .....	32
3.4.10	Smbios Configuration.....	33
	Figure 3.15 South Bridge ACPI Configuration .....	33
3.4.11	USB Configuration .....	33
	Figure 3.16 South Bridge ACPI Configuration .....	33
	Figure 3.17 USB Mass storage Device Configuration .....	34
3.5	Advanced PCI / PnP Settings .....	35
	Figure 3.18 PCI/PNP Setup (top) .....	35
3.6	Boot Settings.....	36
	Figure 3.19 Boot Setup Utility .....	36
3.6.1	Boot Settings Configuration .....	36
	Figure 3.20 Boot Setting Configuration.....	36
3.7	Security Setup.....	37
	Figure 3.21 Password Configuration .....	37
3.8	Advanced Chipset Settings .....	38
	Figure 3.22 Advanced Chipset Settings .....	38
3.8.1	North Bridge Configuration .....	38
	Figure 3.23 North Bridge Configuration .....	38
	Figure 3.24 Video function configuration .....	39
3.8.2	South Bridge Chipset Configuration.....	40
	Figure 3.25 South Bridge Configuration .....	40
3.9	Exit Option.....	41
	Figure 3.26 Exit Option .....	41
3.9.1	Save Changes and Exit .....	41
3.9.2	Discard Changes and Exit .....	41
3.9.3	Load Optimal Defaults .....	41
3.9.4	Load Fail-Safe Defaults .....	42

## **Chapter 4 Software installation .....43**

4.1	Driver Installation .....	44
4.1.1	Chipset driver installation.....	44
4.1.2	Graphic driver installation .....	46
4.1.3	Audio driver installation.....	49
4.1.4	LAN driver installation .....	51

## **Appendix A Function Settings .....55**

A.1	Function Settings .....	56
	Figure A.1 Top View.....	56
	Table A.1: ATX / AT Mode switch.....	56
	Table A.2: Clear CMOS .....	56
	Table A.3: COM1 / COM2 RS232/422/485 select .....	57

## **Appendix B Application Notes .....59**

B.1	WOL Setting.....	60
B.1.1	Introduction .....	60
B.1.2	System requirements - PC Compatible.....	60
B.1.3	How it works.....	61
B.1.4	Magic Packet .....	61



# Chapter 1

## General Introduction

This chapter gives background information on ARK-3403 series.

---

## 1.1 Introduction

ARK-3403 Compact Embedded Box IPC is an ideal, application-ready, system platform solution. All electronics are protected in a compact, sealed, aluminum case for easy embedding in the customer's own housing, or as a stand-alone application, where space is limited and/or the environment harsh.

A solid sealed aluminum case provides vibration and dust resistance while also providing a passive cooling solution. The ARK-3403 provides system integrators with a turn-key solution and versatile application development path without breaking the bank or missing time to market deadlines.

The ARK-3403 has been used as a standalone system, well-mounted and desktop mounted. The system accepts a wide range of power supplies (DC power in) and comes in a footprint of only 220 mm x 102.5 mm x 200 mm (8.66" x 4.04" x 7.87"). The rugged cast aluminum case not only provides great protection for EMI, shock/vibration, cold and heat, but also passive cooling for quiet fanless operation.

The ARK-3403 answers this demand by offering 6 x USB 2.0 ports, 2 x Giga LAN port, audio function, 4 x COM ports and 2 PCI expansion slots; packed into a small rugged unit and powered by an Intel Atom D510 processor. It also supports a wide range of input voltage from 12 VDC to 24 VDC. The ARK-3403 Compact Embedded IPC supports 2 x 2.5" SATA HDD and 1 x Compact Flash card for storage options and it can provide the diversified application field.

## 1.2 Product Features

### 1.2.1 General

- Intel® Atom™ D510 Dual Core 1.66 GHz / D525 Dual Core 1.8 GHz
- Dual display and support for wide screen with high resolution
- Support 2 GbE, eSATA, 6 USB 2.0 and 4 COM ports
- Two internal 2.5" SATA HDD drive bays
- Various expansion interfaces for diverse applications
- Easy integration, easy maintenance, and wide input voltage range

### 1.2.2 Display

- CRT display
- LVDS support: Support 18-bit LVDS (Optional)

### 1.2.3 Power Consumption

- Typical: 13 W (CPU is Intel® Atom™ D510 1.66 GHz and w/o expansion)
- Max: 15 W (CPU is Intel® Atom™ D510 1.66 GHz and w/o expansion)

## 1.3 Hardware Specifications

- CPU: Intel® Atom™ D510 Dual Core 1.66 GHz / D525 Dual Core 1.8 GHz
- System Chipset: Intel ICH8M
- BIOS: AMI™ 16Mbit, SPI
- System Memory: 1 x 200-pin SODIMM socket, support DDR2 667 MHz, up to 2 GB
- SSD: Supports 1 x CF Card Type I/II
- HDD: Supports drive bay space for 2 x SATA 2.5" HDD
- Watchdog Timer: 255-level timer interval, setup by software
- I/O Interface: 2 x RS-232, 2 x RS-232/422/485 port w/RS-485 auto flow control
- USB: 6 x USB ports, Compliant with USB 2.0
- Audio: Line-out, Mic-in, Line-in
- Ethernet: 2 x 10/100/1000 Mbps Ethernet controller, support Wake On LAN
- Expansion:
  - 1 Slot PCI and 1 Slot PCIe X 1
  - 2 Slots PCIe x 1 (Optional)
  - 2 Slots PCI (Optional)
  - 2 x Mini PCIe

## 1.4 Mechanical Specifications

### 1.4.1 Dimensions

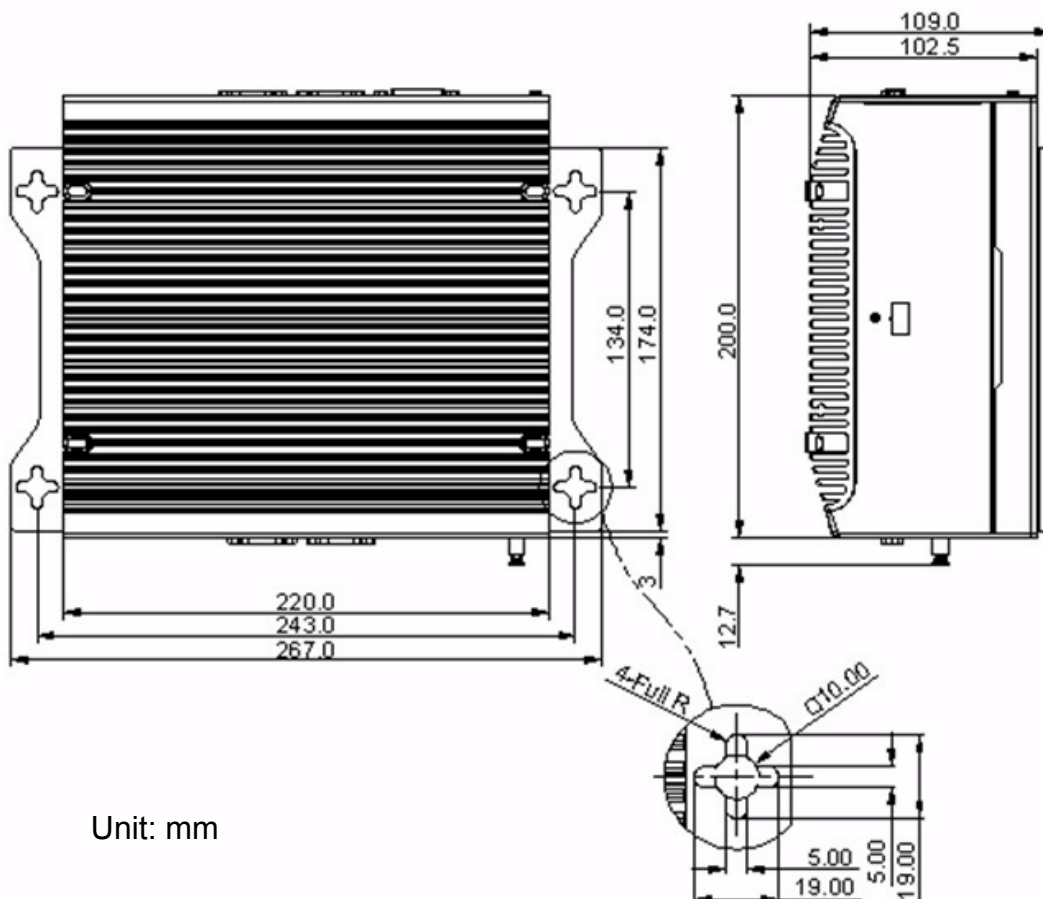

Figure 1.1 ARK-3403 Mechanical dimension drawing

---

## 1.4.2 Weight

4 kg (8.8 lb)

## 1.5 Power Requirement

### 1.5.1 System Power

Minimum power input: 12Vdc - 24Vdc @ 4.6A - 2.4A

### 1.5.2 RTC Battery

3 V / 210 mAh CR2032

## 1.6 Environmental Specifications

### 1.6.1 Operation Temperature

- With Industrial Grade CompactFlash Disk: -20 ~ 55° C
- With 2.5-inch extended temperature hard disk 0 ~ 45° C, with air flow, speed = 0.7 m/sec

### 1.6.2 Relative Humidity

95% @ 40° C (non-condensing)

### 1.6.3 Storage Temperature

-40 ~ 85° C (-40 ~ 185° F)

### 1.6.4 Vibration loading during operation

- With CompactFlash Disk: 5 Grms, IEC60068-2-64, random, 5 ~ 500 Hz, 1 Oct./min, 1 hr/axis
- With 2.5-inch hard disk: 1 Grms, IEC60068-2-64, random, 5 ~ 500 Hz, 1 Oct./min, 1 hr/axis

### 1.6.5 Shock during operation

- With CompactFlash Disk: 50 G, IEC60068-2-27, half sine, 11 ms duration
- With 2.5-inch hard disk: 20 G, IEC60068-2-27, half sine, 11 ms duration

### 1.6.6 EMC

CE/FCC Class A, CCC, BSMI

### 1.6.7 Safety

UL, CCC, BSMI

# Chapter 2

## Hardware Installation

This chapter introduces external IO and the installation of ARK-3403 Hardware.

## 2.1 ARK-3403 I/O indication

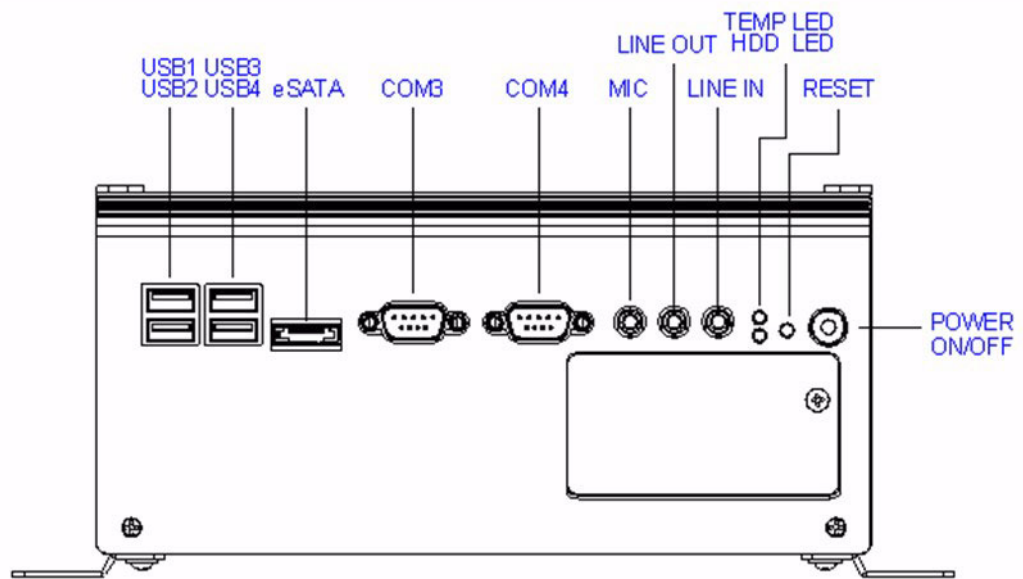

Figure 2.1 ARK-3403 Front view

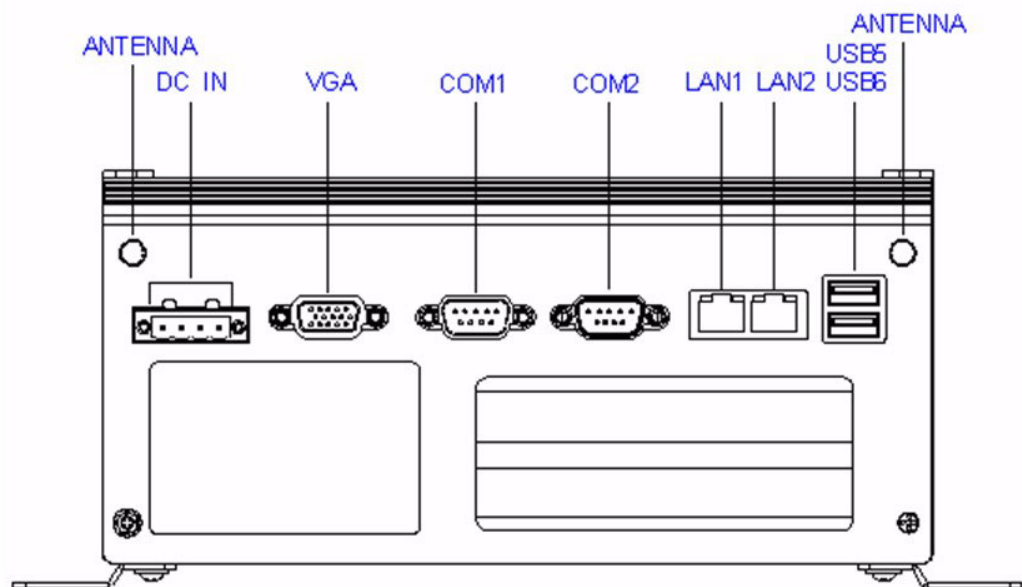

Figure 2.2 ARK-3403 Rear view



## 2.2 ARK-3403 front side external I/O connectors

### 2.2.1 Power ON/OFF Button

ARK-3403 comes with a Power On/Off button with LED indicators on the front side to show its On status (Green LED) and Off/Suspend status (Orange LED), that support dual function of Soft Power -On/Off (Instant off or Delay 4 Second), and Suspend.



Figure 2.3 Powers ON/OFF Button

### 2.2.2 Reset Button

ARK-3403 has a Reset button on front side. Press the button to activate the reset function.



Figure 2.4 Reset Button

### 2.2.3 LED Indicators

There are two LED on ARK-3403 front metal face plate for indicating system status: Thermal LED is for system thermal alarm status; and HDD LED is for HDD & compact flash disk status.

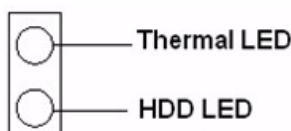

Figure 2.5 LED Indicators

### 2.2.4 Audio Connector

ARK-3403 offers stereo audio ports by three phone jack connectors of Speaker Out, Line In, Mic-In, the audio chip control by ALC888, it's compliant with Azalea standard, the Speaker Out support 3D surround stereo sound and dual 2.2 W amplifier.

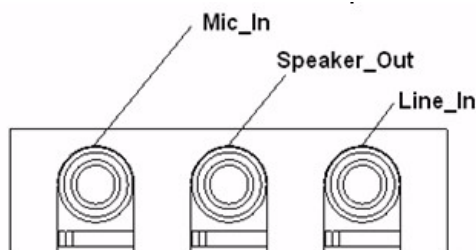

Figure 2.6 Audio jack connectors

## 2.2.5 COM Connector

ARK-3403 provides 6 D-sub 9-pin connectors that is serial communication interface ports. The COM1/2 in the rear side support RS-232/422/485 mode by BIOS select, the COM3/4 in the front side and the COM5/6(CN19/CN21) internal by header is only support RS-232. The COM1/2 default setting is RS-232, if you want to use RS-422/485, you can find the select item in the BIOS setup.

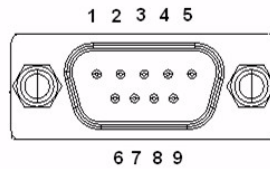

Figure 2.7 COM port connector

Table 2.1: COM standard serial port pin assignments

	RS-232	RS-422	RS-485
Pin	Signal Name	Signal Name	Signal Name
1	DCD	Tx-	DATA-
2	RxD	Tx+	DATA+
3	TxD	Rx+	NC
4	DTR	Rx-	NC
5	GND	GND	GND
6	DSR	NC	NC
7	RTS	NC	NC
8	CTS	NC	NC
9	RI	NC	NC

Note: NC represents “No Connection”.

## 2.2.6 e-SATA Connector

ARK-3403 has a 7 pin external connector for e-SATA device. That is fully compliant with SATA I/SATA II standards, its can be access with external SATA I/SATA II device then up to 300MB/sec.

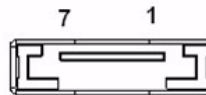

Figure 2.8 e-SATA connector

## 2.2.7 USB Connector

ARK-3403 provides six connectors of USB interface, which give complete Plug & Play and hot swapping for up to 127 external devices. The USB interface complies with USB UHCI, Rev. 2.0 compliant. The USB interface can be disabled in the system BIOS setup. Please refer to Table. 2.2 For its pin assignments.

The USB connectors are used for connecting any device that conforms to the USB interface. Many recent digital devices conform to this standard. The USB interface supports Plug and Play, which enables you to connect or disconnect a device whenever you want, without turning off the computer.

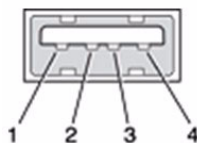

Figure 2.9 USB connector

Table 2.2: USB Connector

Pin	Signal Name	Signal Name	Signal Name
1	VCC	2	USB data-
3	USB data+	4	GND

## 2.2.8 Compact Flash Card

ARK-3403 is equipped with an external CF card. You can find the installation in Chapter 2.5.

## 2.3 ARK-3403 rear side external I/O connectors

### 2.3.1 Power Input Connector

ARK-3403 comes with a two pins header that carries 12~24 VDC external power input.

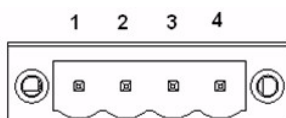

Figure 2.10 Power Input Connector

Table 2.3: Power connector pin assignments

Pin	Signal Name
1	GND
2	+12~24VDC
3	+12~24VDC
4	GND

### 2.3.2 VGA Connector

The ARK-3403 offers a high resolution VGA interface via D-Sub 15 pin connector to support a VGA monitor. It supports VGA and VESA, the display output resolution up to 2048 \* 1536 @ 60 Hz.

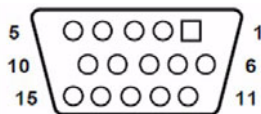

Figure 2.11 VGA connector

Table 2.4: VGA Connector pin assignments

Pin	Signal Name	Pin	Signal Name
1	RED	2	GREEN
3	BLUE	4	NC
5	GND	6	GND
7	GND	8	GND
9	NC	10	GND
11	NC	12	DDC DATA
13	H-SYNC	14	V-SYNC
15	DDC CLOCK		

### 2.3.3 Ethernet Connector (LAN)

ARK-3403 provides two RJ45 connectors of Gigabit LAN interface, is equipped with Intel 82567V and 82583V Ethernet controller that is fully compliant with IEEE 802.3u 10/100/1000Base-T CSMA/CD standards. The Ethernet port provides a standard RJ-45 jack connector with LED indicators on the front side to show its Active/Link status (Green LED) and Speed status (Yellow LED).

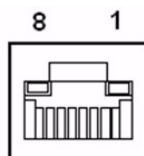

Figure 2.12 RJ-45 Ethernet connector

Table 2.5: RJ-45 Connector pin assignments

Pin	Signal Name
1	TX+
2	TX-
3	RX+
4	MDI2+
5	MDI2-
6	RX-
7	MDI3+
8	MDI3-

### 2.3.4 LVDS Connector (Optional)

The ARK-3403 comes with a D-Sub 26-pin connector that carries LVDS signal output, and can direct connect to LVDS LCD Display via external cable. The system also provides power of 3.3V.

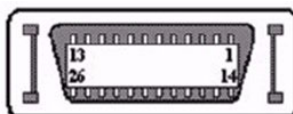

Figure 2.13 LVDS connector

Table 2.6: CN35 LVDS Connector Pin Assignment			
Pin	Signal Name	Pin	Signal name
1	N/C	14	N/C
2	GND	15	LVDS_YAM0
3	LVDS_YAP0	16	LVDS_YAM1
4	LVDS_YAP1	17	LVDS_YAM2
5	LVDS_YAP2	18	LVDS_CLKAM
6	LVDS_CLKAP	19	GND
7	+3.3	20	+3.3
8	N/C	21	N/C
9	N/C	22	N/C
10	N/C	23	N/C
11	N/C	24	N/C
12	N/C	25	N/C
13	N/C	26	N/C

### 2.3.5 LCD backlight On/Off control Connector (Optional)

The ARK-3403 comes with a D-Sub 9-pin connector which provides BKLTEN signal as well as +12V, +5V and Ground Pin signals that allow the user to connect these signals to LCD Inverter to implement the LCD On/Off control.

- Provides BKLTEN signal that inverter Module requires for inverter on/off control.
- Provides +12V, + 5V as the Inverter Power Source. The additional VBR signal pin could be connected to LCD's Inverter that allows the user to achieve brightness adjustment through customer's software utility.

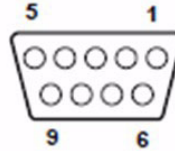

Figure 2.14 LCD backlight connector

Table 2.7: CN34 LCD Backlight Connector Pin Assignment

Pin	Signal name	Pin	Signal name
1	+12 V	6	Reserved
2	GND	7	Reserved
3	BKLTEN	8	Reserved
4	VBR	9	Reserved
5	+5 V		

### 2.3.6 LPT Connector (Optional)

The ARK-3403 provides one D-sub 25-pin female connector, which offers printers or other communication interface port. If you want to use LPT port, you can find the Pin assignment as following.

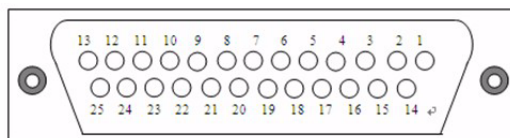

Figure 2.15 LPT connector

Table 2.8: CN29 LPT Connector Pin Assignment

Pin	Signal Name	Pin	Signal name
1	STROBE	14	ALF
2	PD0	15	ERROR
3	PD1	16	INIT
4	PD2	17	SLCTIN
5	PD3	18	GND
6	PD4	19	GND
7	PD5	20	GND
8	PD6	21	GND
9	PD7	22	GND
10	ACK	23	GND
11	BUSY	24	GND
12	PE	25	GND
13	SLCT		

### 2.3.7 DIO Connector (Optional)

The ARK-3403 provides one D-sub 25-pin male connector, which offers Digital I/O communication interface port. If you want to use DIO port, you can find the Pin assignment as following.

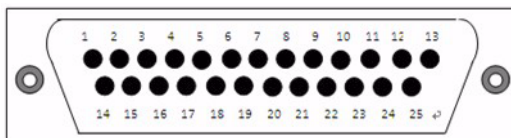

Figure 2.16 DIO connector

Table 2.9: CN32 DIO Connector Pin Assignment

Pin	Signal Name	Pin	Signal name
1	DIO0-0	14	DIO1-0
2	DIO0-1	15	DIO1-1
3	DIO0-2	16	DIO1-2
4	DIO0-3	17	DIO1-3
5	DIO0-4	18	DIO1-4
6	DIO0-5	19	DIO1-5
7	DIO0-6	20	DIO1-6
8	DIO0-7	21	DIO1-7
9	GND	22	GND
10	GND	23	GND
11	GND	24	GND
12	+5V	25	+5V
13	+5V		



## 2.4 Memory Installation

1. Remove top screws and heatsink.
2. Remove the heatspreader by unscrewing the 5 screws.
3. Insert the memory module into the SODIMM socket.
4. Reverse steps to reassemble.

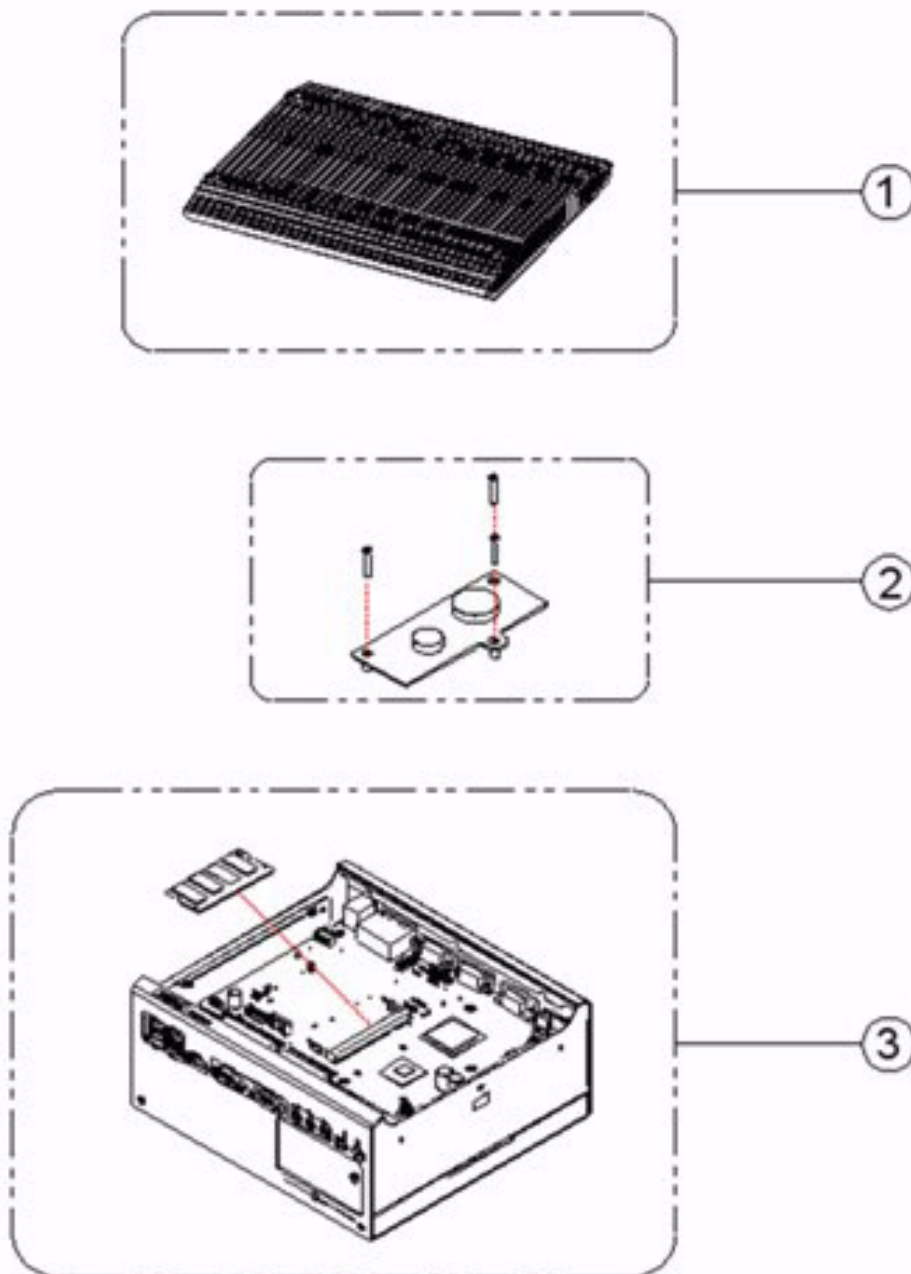

Figure 2.17 Memory installation

## 2.5 Compact Flash installation

1. Open the front CF/HDD door by loosening the door screw.
2. Insert the CF card into the CF socket.
3. Reverse steps to reassemble.

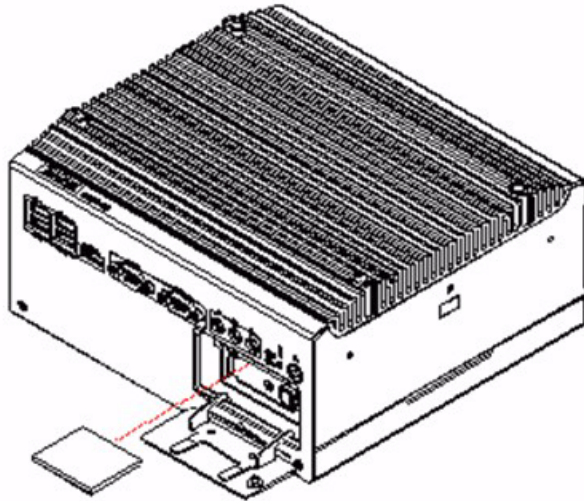

Figure 2.18 CF card installation

## 2.6 HDD installation

### 2.6.1 Internal fixed HDD installation

1. Remove 4 retaining screws and the bottom cover.
2. Install the 2.5-inch SATA HDD with 4 HDD screws.
3. Connect the SATA signal cable and power cable. Reverse steps to reassemble.

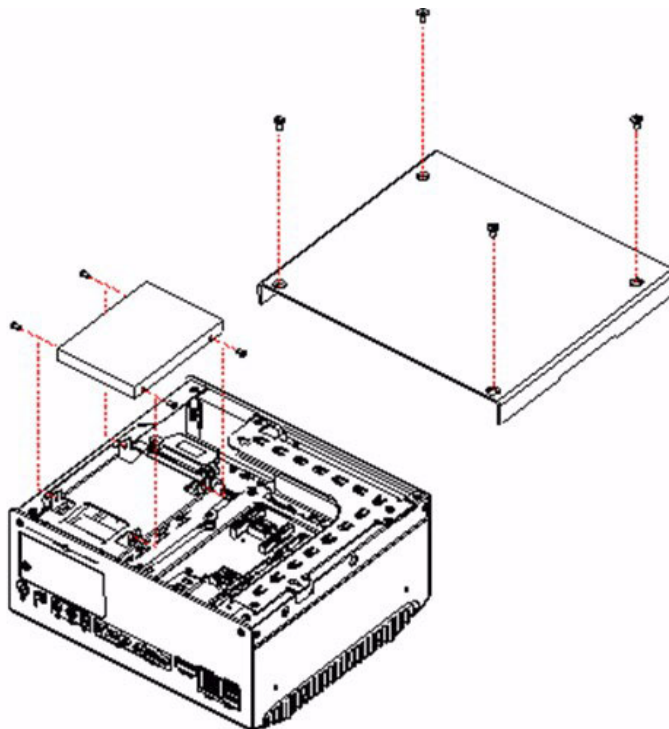

Figure 2.19 Internal fixed HDD installation

## 2.6.2 Removable HDD installation

1. Loosen door screw and open front CF/HDD door.
2. Attach the 2.5-inch SATA HDD on the loader with 4 HDD screws.
3. Slide in HDD loader along the rails to the end and fix with lever screw.
4. Close door and fasten.

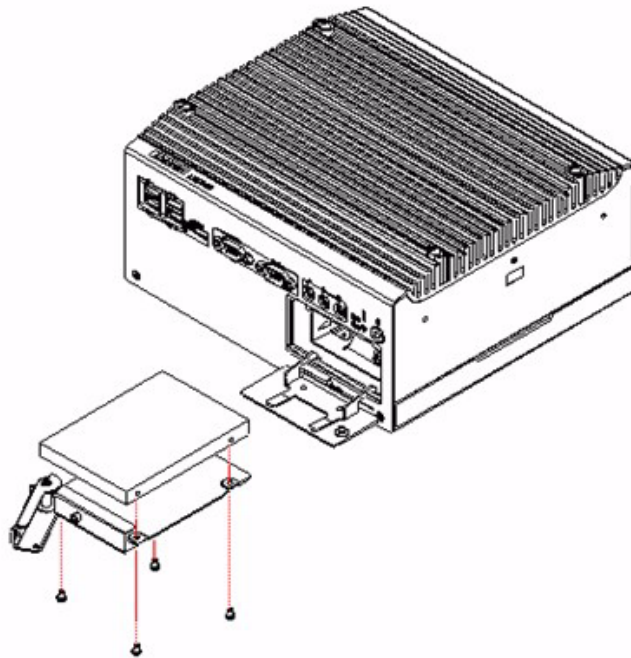

Figure 2.20 Removable HDD installation

## 2.7 PCI card installation

1. Remove the 4 bottom screws and bottom cover.
2. Remove the riser card module.
3. Insert the PCI extension card into the PCI slot of the riser card module.
4. Reattach the riser card module.
5. Replace bottom cover and secure with the 4 screws.

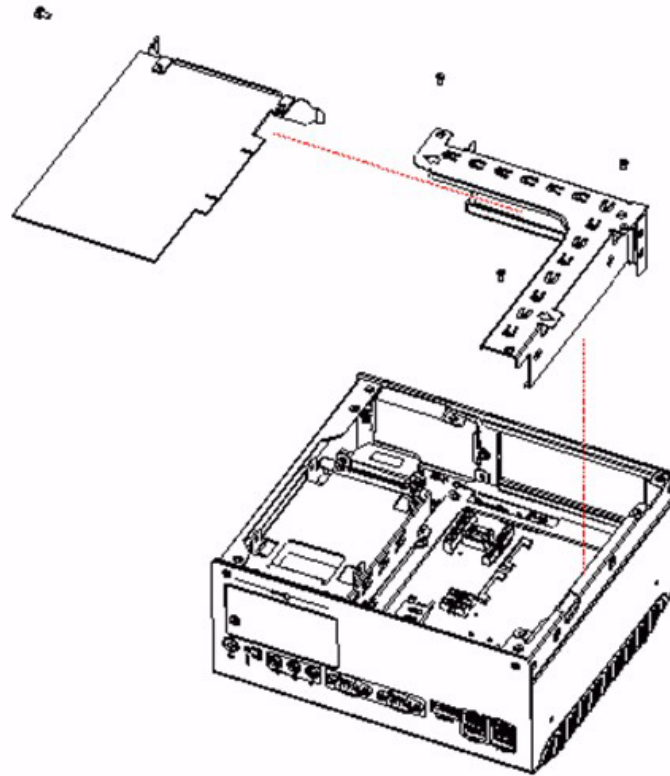

Figure 2.21 Removable PCI Installation

## 2.8 Mini PCIe installation

1. Open the bottom cover and remove the Riser card module. (Refer Chapter 2.4)
2. Insert the Mini PCIe card into the Mini PCIe socket and latch into place.

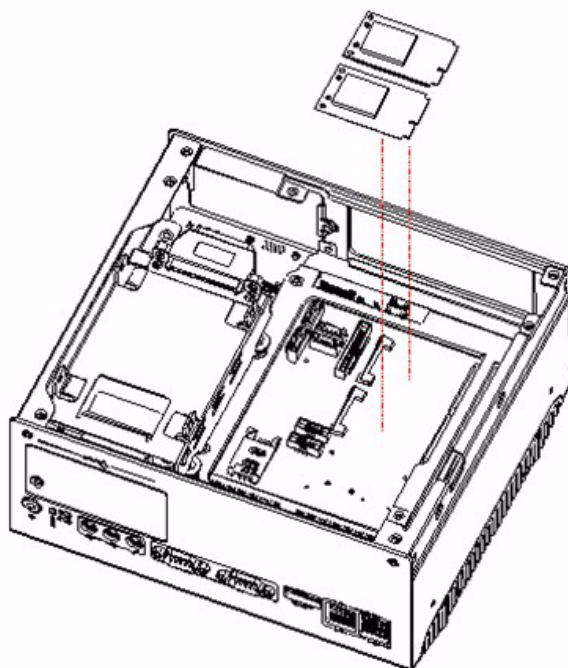

Figure 2.22 Mini PCIe Card Installation

## 2.9 Antenna installation

1. Remove top screws and heatsink. (Refer Chapter 2.1)
2. Pass the internal antenna cable jack through the antenna hole on the rear panel and fix it in place with the matching nut.
3. Attache the external antenna.
4. Reattach heatsink.

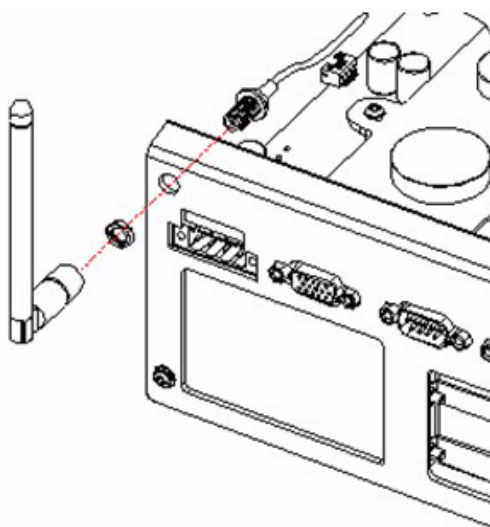

Figure 2.23 Antenna installation



# Chapter 3

## BIOS Settings

This chapter introduces how to set BIOS configuration data.

## 3.1 BIOS Introduction

Advantech provides the latest, full-featured AMI BIOS; AMI BIOSs have been integrated into squillions of motherboards for over two decades. With the AMI BIOS Setup program, users can modify BIOS settings and control various system features. This chapter describes the basic navigation of the ARK-3403 BIOS setup screens.

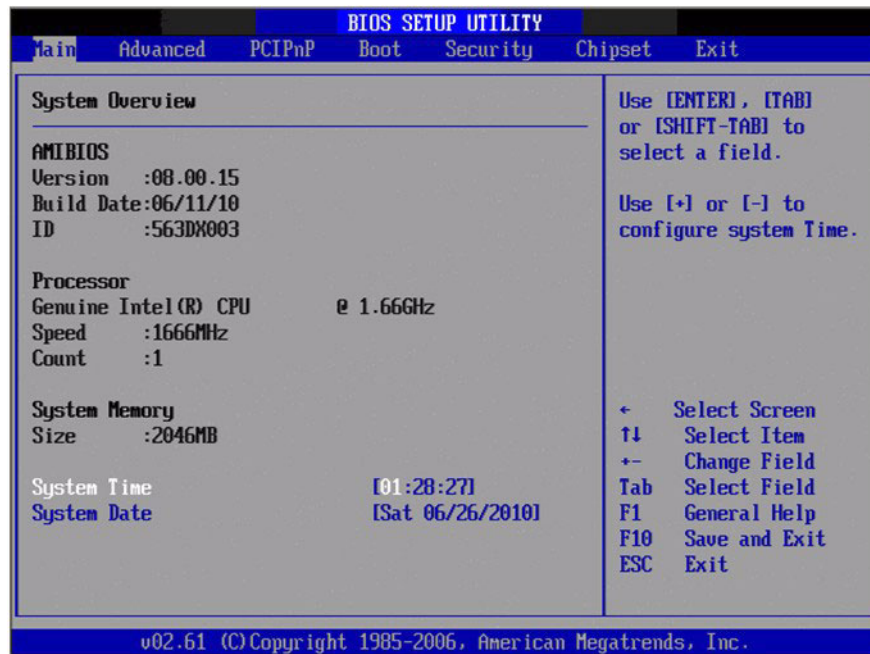

Figure 3.1 Setup program initial screen

AMI's BIOS ROM has a built-in Setup program that allows users to modify the basic system configuration. This information is stored in NVRAM area so it retains the Setup information when the power is turned off.

## 3.2 Entering BIOS Setup

Turn on the computer and check for the "patch code". If there is a number assigned to the patch code, the on board CPU is supported by current BIOS. If there is no number assigned to the patch code, please contact an Advantech application engineer to obtain an up-to-date patch code file. After ensuring that the system status of the CPU is valid, press <Del> to enter the Setup menu.



## 3.3 Main Setup

When users first enter the BIOS Setup Utility, they will enter the Main setup screen. Users can always return to the Main setup screen by selecting the Main tab. There are two Main Setup options. They are described in this section. The Main BIOS Setup screen is shown below.

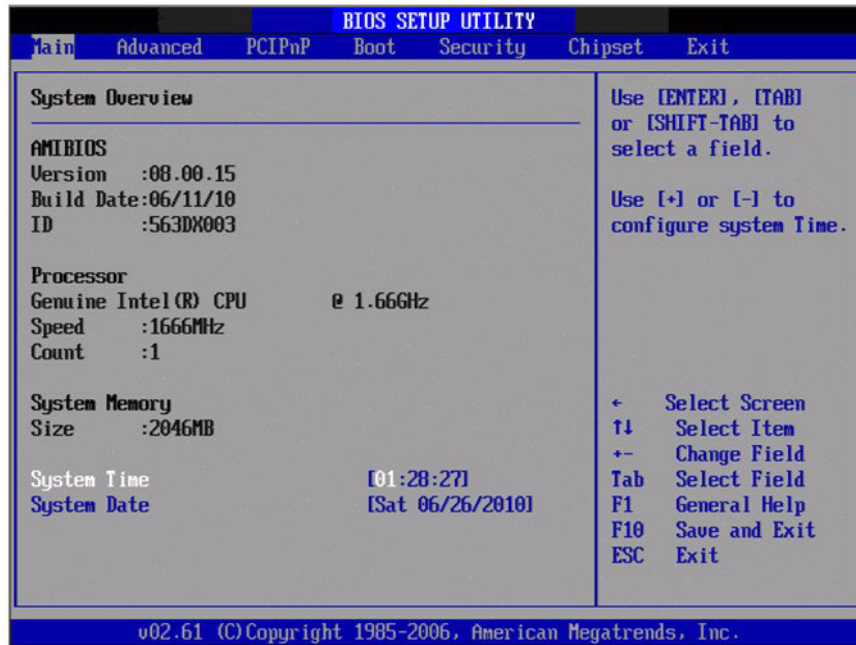

Figure 3.2 Main setup screen

The Main BIOS setup screen has two main frames. The left frame displays all the options that can be configured. Grayed-out options cannot be configured; options in blue can. The right frame displays the key legend.

Above the key legend is an area reserved for a text message. When an option is selected in the left frame, it is highlighted in white. Often a text message will accompany it.

### 3.3.1 System time / System date

Use this option to change the system time and date. Highlight System Time or System Date using the <Arrow> keys. Enter new values through the keyboard. Press the <Tab> key or the <Arrow> keys to move between fields. The date must be entered in MM/DD/YY format. The time must be entered in HH:MM:SS format.

## 3.4 Advanced BIOS Features Setup

Select the Advanced tab from the ARK-3403 setup screen to enter the Advanced BIOS Setup screen. You can select any of the items in the left frame of the screen, such as CPU Configuration, to go to the sub menu for that item. You can display an Advanced BIOS Setup option by highlighting it using the <Arrow> keys. All Advanced BIOS Setup options are described in this section. The Advanced BIOS Setup screen is shown below. The sub menus are described on the following pages.

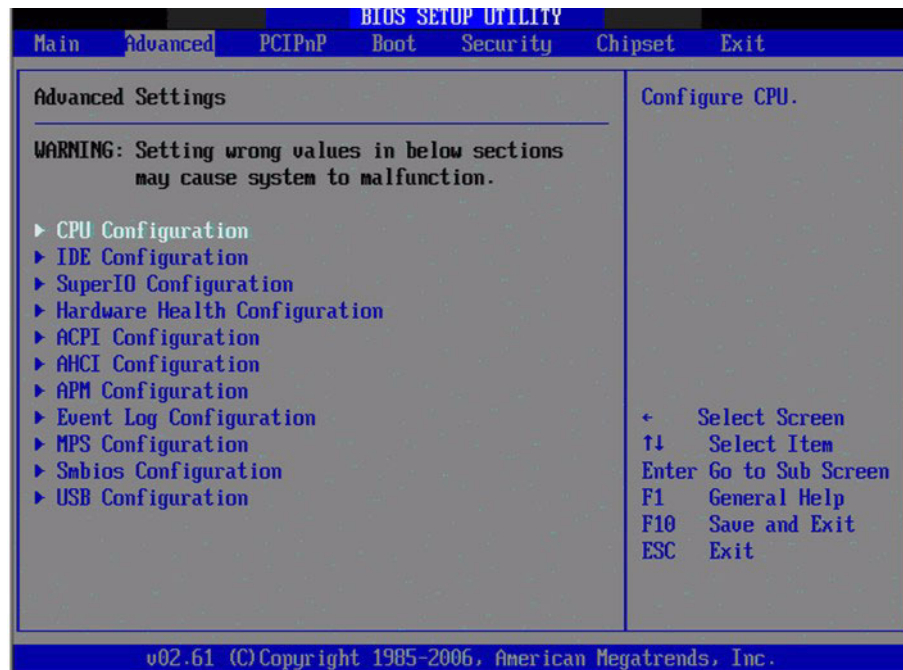

Figure 3.3 Advanced BIOS features setup screen

### 3.4.1 CPU Configuration

- **Max CPUID Value Limit**  
This item allows you to limit CPUID maximum value.
- **Execute-Disable Bit Capability**  
This item allows you to Enable or Disable the No-Execution page protection technology.
- **Hyper Threading Technology**  
This item allows you to Enable or Disable Intel Hyper Threading technology.
- **Intel® SpeedStep™ tech**  
When set to disabled, the CPU runs at its default speed, when set to enabled, the CPU speed is controlled by the operating system.
- **Intel® C-STATE tech**  
This item allows the CPU to save more power under idle mode.
- **Enhanced C-States**  
CPU idle set to enhanced C-States, disabled by Intel® C-STATE tech item.

### 3.4.2 IDE Configuration



Figure 3.4 IDE Configuration

- **ATA/IDE Configuration**  
This item allows you to select Disabled / Compatible / Enhanced.
- **Legacy IDE Channels**  
When set to Enhanced mode you can select IDE or AHCI mode. When select Compatible mode you can select SATA only / SATA pri, PATA sec or PATA only.
- **Primary/Secondary/Third IDE Master/Slave**  
BIOS auto detects the presence of IDE device, and displays the status of auto detection of IDE device.
  - Type: Select the type of SATA driver.[Not Installed][Auto][CD/DVD][ARMD].
  - LBA/Large Mode: Enables or Disables the LBA mode.
  - Block (Multi-Sector Transfer): Enables or disables data multi-sectors transfers.
  - PIO Mode: Select the PIO mode.
  - DMA Mode: Select the DMA mode.
  - S.M.A.R.T.: Select the smart monitoring, analysis, and reporting technology.
  - 32Bit Data Transfer: Enables or disables 32-bit data transfer.
- **Hard Disk Write Protect**  
Disable/Enable device write protection. This will be effective only if device is accessed through BIOS.
- **IDE Detect Time Out (Sec)**  
This item allows you to select the time out value for detecting ATA/ATAPI device(s).

### 3.4.3 Super IO Configuration

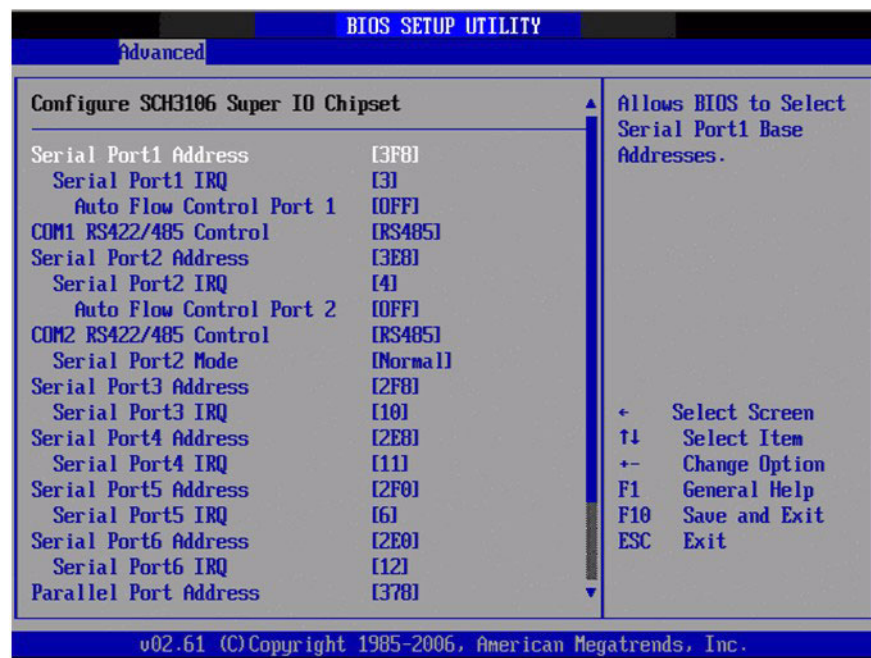

Figure 3.5 Super I/O Configuration

- **Serial Port1 / Port2 / Port3 / Port 4 / Port 5 / Port 6 address**  
This item allows you to select serial port1 ~ port6 base addresses.
- **Serial Port1 / Port2 / Port3 / Port 4 / Port 5 / Port 6 IRQ**  
This item allows you to select serial port1 ~ port6 IRQs.
- **Auto Flow Control Port1 / Port2**  
This item allows you to enable or disable auto flow control function. When Disabled, auto flow control is RS232.
- **Parallel Port Address**  
This item allows you to select parallel port base addresses.
- **Parallel Port Mode**  
This item allows you to select parallel port mode.
- **Parallel Port IRQ**  
This item allows you to select parallel port IRQ.
- **LPT/FDD Switch**  
This function will switch LPT port to FDD mode.
- **WatchDog Function**  
WatchDog function support (Seconds/Minutes).

### 3.4.4 Hardware Health Configuration

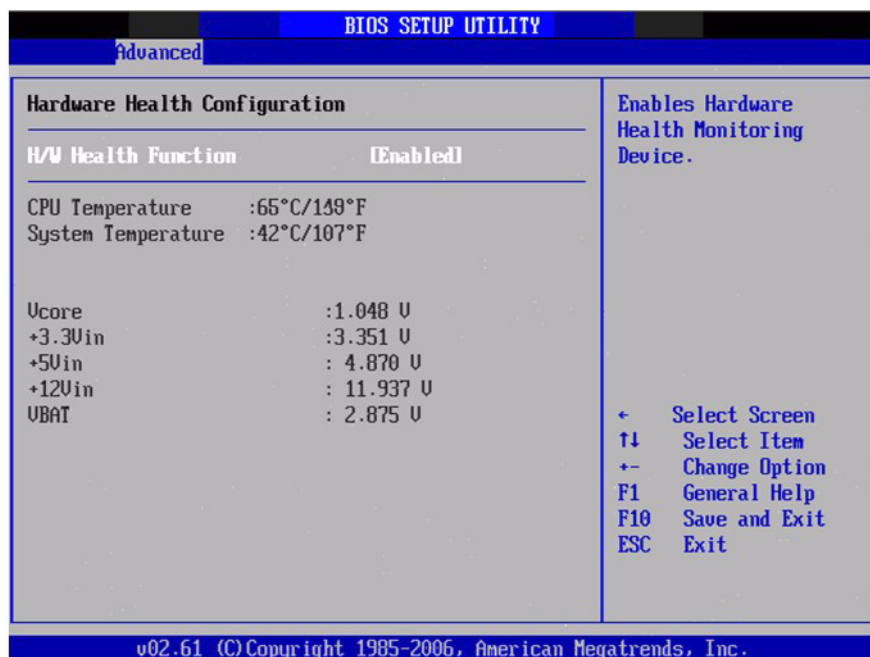

Figure 3.6 Hardware Health Configuration

- **H/W Health Function**  
This item allows you to enable or disable H/W monitoring.
- **Temperature & Voltage show**  
CPU/System Temperature  
Vcore / +3.3Vin / +5Vin / +12Vin / VBAT

### 3.4.5 ACPI Configuration

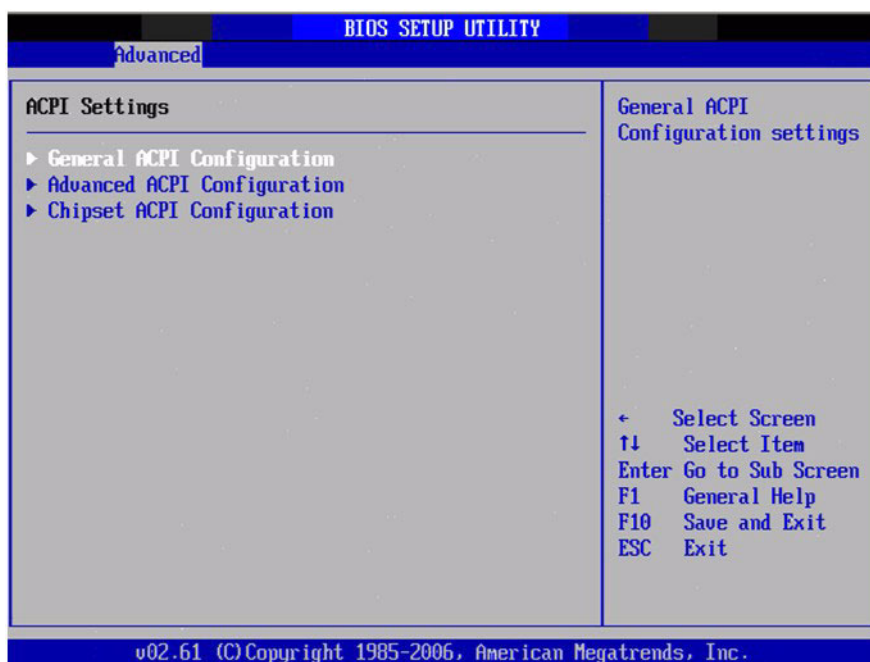

Figure 3.7 ACPI Settings

### 3.4.5.1 General ACPI Configuration

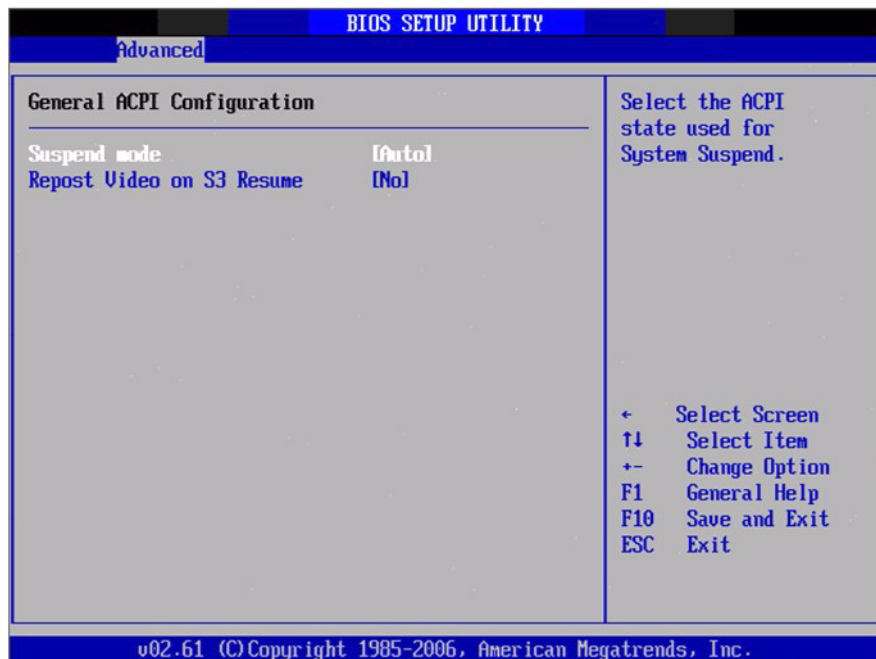

Figure 3.8 General ACPI Configuration

- **Suspend mode**  
Select the ACPI states used for system suspend.
- **Report Video on S3 Resume**  
This item allows you to invoke VA BIOS POST on S3/STR resume.

### 3.4.5.2 Advanced ACPI Configuration

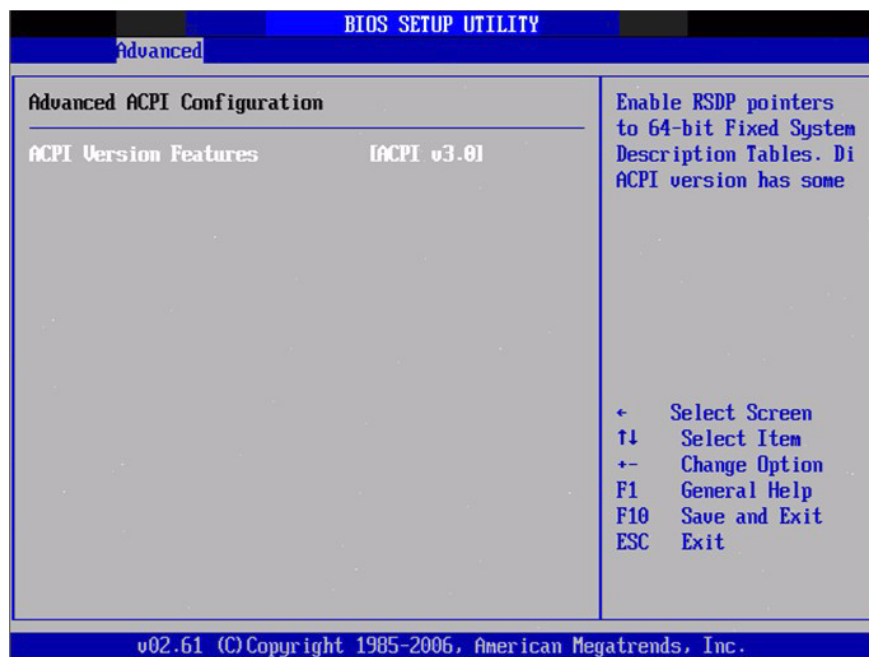

Figure 3.9 Advanced ACPI Configuration

- **ACPI Version Features**  
This item allows you to enable RSDP pointers to 64-bit fixed system description tables.



### 3.4.5.3 Chipset ACPI Configuration

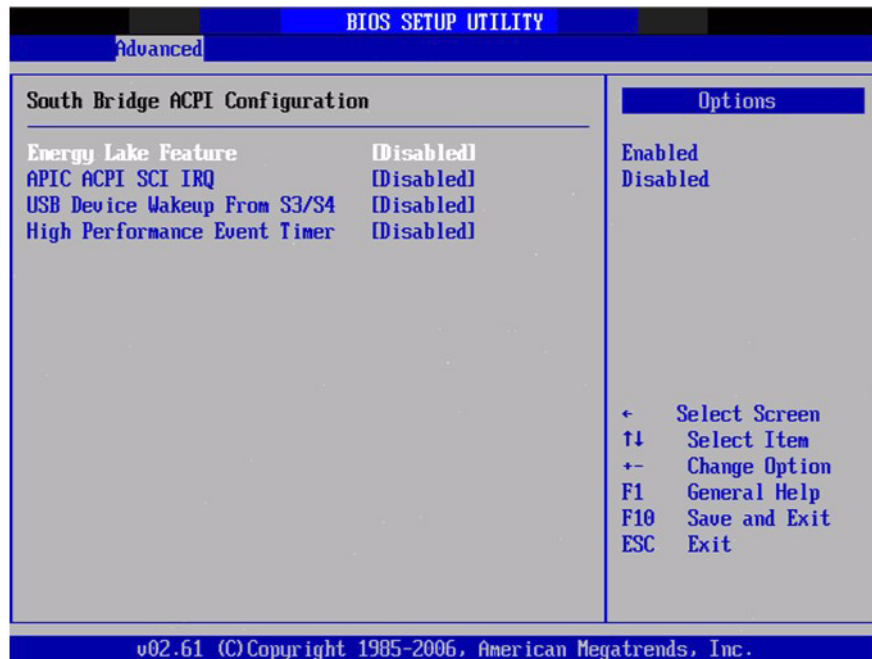

Figure 3.10 Chipset ACPI Configuration

- **Energy Lake Feature**  
Allows you to configure Intel's Energy Lake power management technology.
- **APIC ACPI SCI IRQ**  
Enable/Disable APIC ACPI SCI IRQ.
- **USB Device Wakeup From S3/S4**  
Enable/Disable USB Device Wakeup from S3/S4.
- **High Performance Event Timer**  
Enable / Disable High performance Event timer.

### 3.4.6 AHCI Configuration

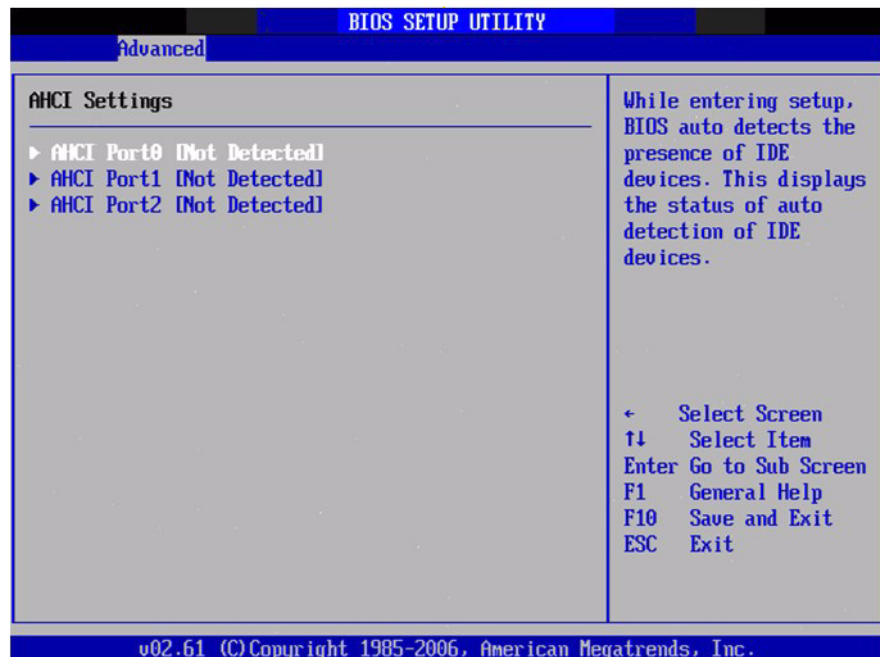

Figure 3.11 Advanced ACPI Configuration

- **AHCI Ports0 / Port1 / Port2**

While entering setup, BIOS auto detects the presence of IDE devices. This displays the status of auto detected IDE devices.

### 3.4.7 APM Configuration

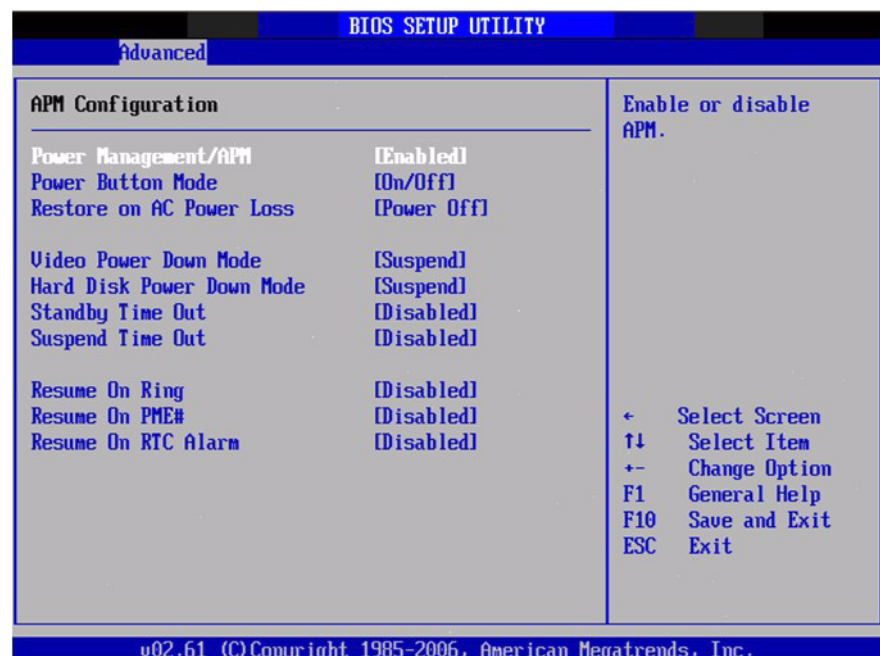

Figure 3.12 APM Configuration



- **Power Management/APM**  
Enable or disable APM.
- **Power Button Mode**  
Power on, off, or enter suspend mode when the power button is pressed. The following options are also available.
- **Restore on AC power Loss**  
Use this to set up the system response after a power failure. The "Off" setting keeps the system powered off after power failure, the "On" setting boots up the system after failure, and the "Last State" returns the system to the status just before power failure.
- **Video Power Down Mode**  
Power down video in suspend or standby mode.
- **Hard Disk Power Down Mode**  
Power down Hard Disk in suspend or standby mode.
- **Standby Time Out**  
Go into standby in the specified time.
- **Suspend Time Out**  
Go into Suspend in the specified time.
- **Resume On Ring**  
Enable / Disable RI to generate a wake event.
- **Resume On PME#**  
Enable / Disable PME to generate a wake event.
- **Resume On RTC Alarm**  
Enable / Disable RTC to generate a wake event.

### 3.4.8 Event Log Configuration



Figure 3.13 South Bridge ACPI Configuration

- **View Event Log**  
View all unread events on the event Log.
- **Mark all events as read**  
Mark all unread events as read.
- **Clear Event Log**  
Discard all events in the event Log.

### 3.4.9 MPS Configuration

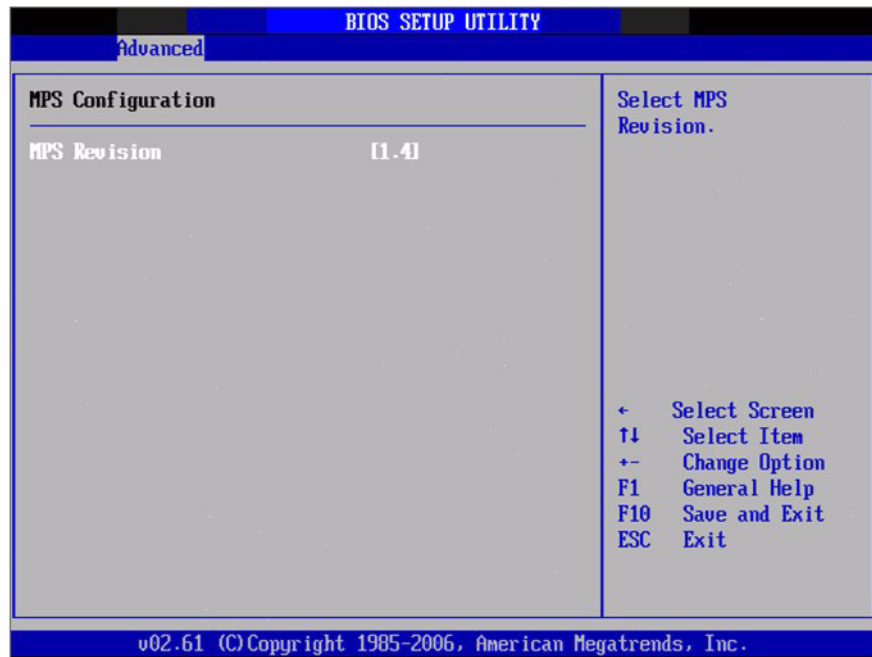

Figure 3.14 South Bridge ACPI Configuration

- **MPS Revision**  
This item allows you to select MPS reversion.

### 3.4.10 Smbios Configuration

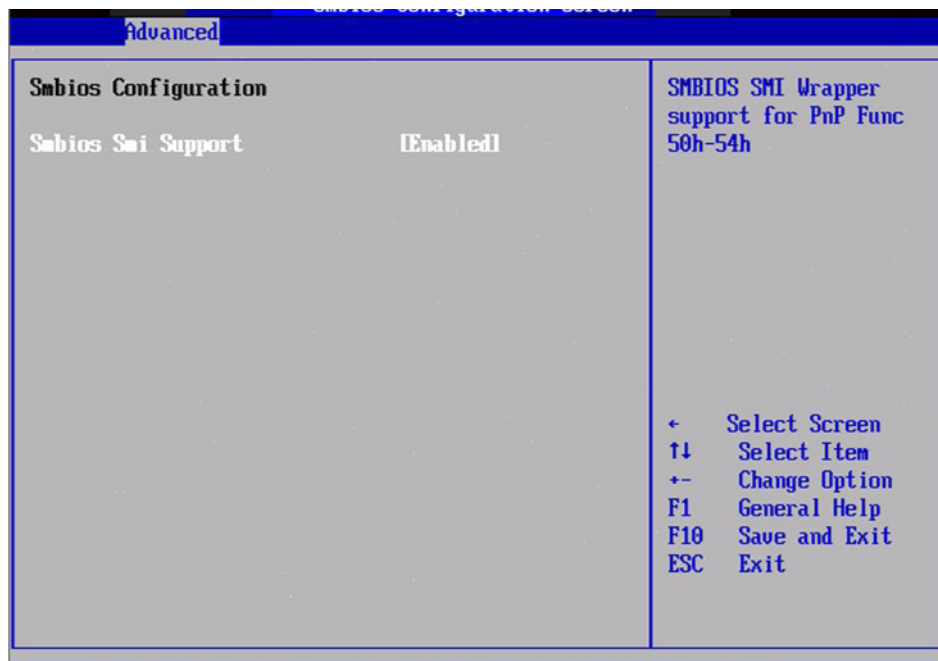

Figure 3.15 South Bridge ACPI Configuration

- **SMBIOS SMI Support**  
SMBIOS SMI wrapper support for PnP function 50h-54h.

### 3.4.11 USB Configuration

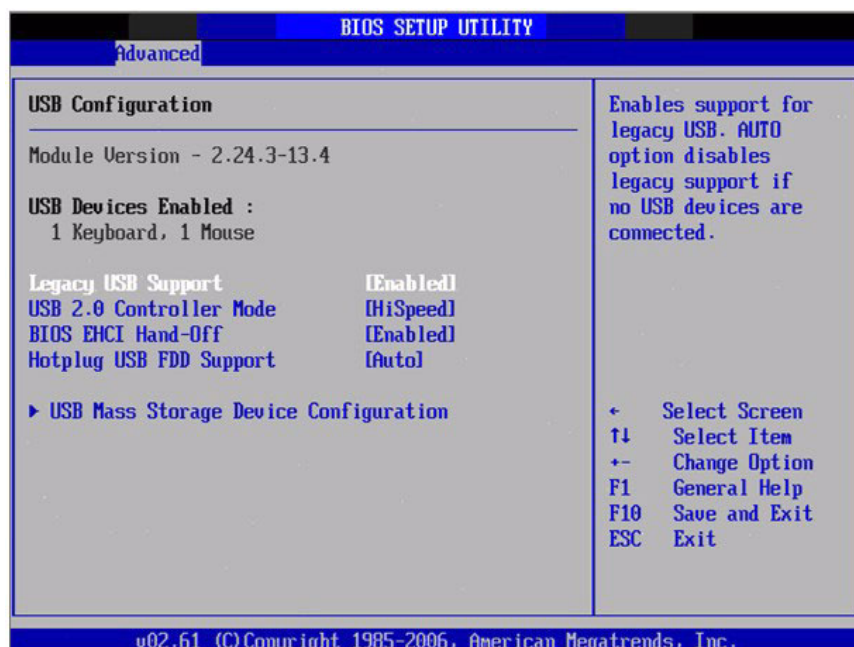
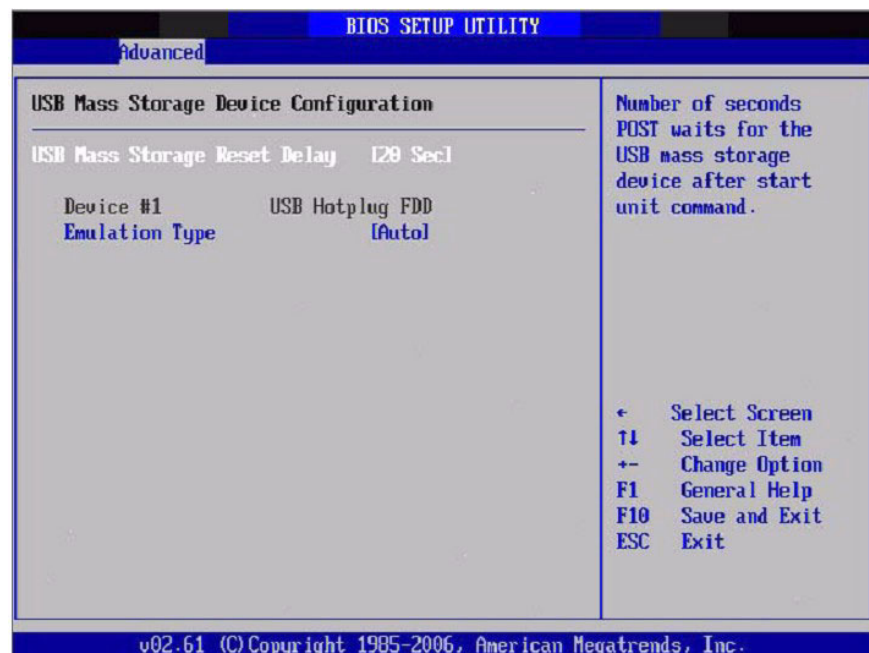

Figure 3.16 South Bridge ACPI Configuration

- **Legacy USB Support**  
Enables support for legacy USB. Auto option disables legacy support if no USB devices are connected.
- **USB 2.0 Controller Mode**  
This item allows you to select HiSpeed(480Mbps) or FullSpeed (12Mbps).
- **BIOS EHCI Hand-Off**  
This is a workaround for OSeS without EHCI hand-off support. The EHCI ownership change should be claimed by EHCI driver.
- **Hotplug USB FDD Support**  
A dummy FDD device is created that will be associated with the hot plugged FDD later. Auto option creates this dummy device only if there is no USB FDD present.
- **USB Mass Storage Device Configuration**



**Figure 3.17 USB Mass storage Device Configuration**

- **USB Mass Storage Reset Delay**  
Number of seconds POST waits for the USB mass storage device after start unit command.
- **Emulation Type**  
If Auto, USB devices less than 530 MB will be emulated as Floppy and larger as hard drive. Force FDD option can be used to force a FDD formatted drive to boot as FDD (E.G., a ZIP drive).

## 3.5 Advanced PCI / PnP Settings

Select the PCI/PnP tab from the ARK-3403 setup screen to enter the Plug and Play BIOS Setup screen. You can display a Plug and Play BIOS Setup option by highlighting it using the <Arrow> keys. All Plug and Play BIOS Setup options are described in this section. The Plug and Play BIOS Setup screen is shown below.

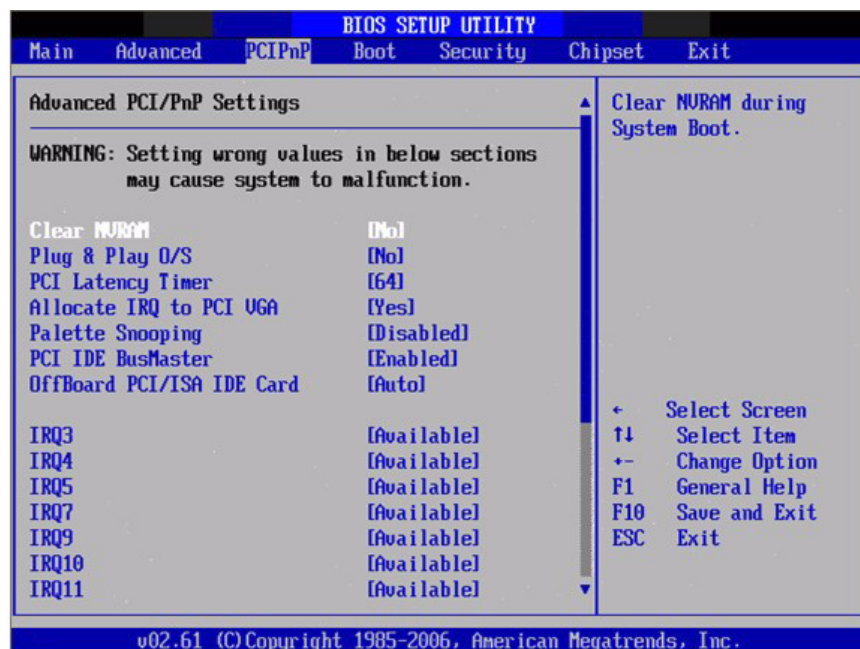

Figure 3.18 PCI/PNP Setup (top)

- **Clear NVRAM**  
Set this value to force the BIOS to clear the Non-Volatile Random Access Memory (NVRAM). The Optimal and Fail-Safe default setting is No.
- **Plug & Play O/S**  
When set to No, BIOS configures all the device in the system. When set to Yes and if you install a Plug and Play operating system, the operating system configures the Plug and Play device not required for boot.
- **PCI Latency Timer**  
Value in units of PCI clocks for PCI device latency timer register.
- **Allocate IRQ to PCI VGA**  
When set to Yes, will assign an IRQ to PCI VGA card if card requests IRQ. When set to No, will not assign IRQ to PCI VGA card even if card requests an IRQ.
- **Palette Snooping**  
This item is designed to solve problems caused by some non-standard VGA cards.
- **PCI IDE BusMaster**  
When set to enabled BIOS uses PCI busmastering for reading/writing to IDE drives.
- **OffBoard PCI/ISA IDE Card**  
Some PCI IDE cards may require this to be set to the PCI slot number that is holding the card. When set to Auto will work for most PCI IDE cards.
- **IRQ3 / 4 / 5 / 7 / 9 / 10 / 11**  
This item allows you to assign IRQ-3, 4, 5, 7, 9, 10, 11 respectively.

- **DMA Channel0 / 1 / 3 / 5 / 6 / 7**  
When set to Available, the specified DMA is available for use by PCI/PnP devices.  
When set to Reserved, the specified DMA will be reserved for legacy ISA devices.
- **Reserved Memory Size**  
Use to set size of reserved memory block for legacy ISA device.

## 3.6 Boot Settings

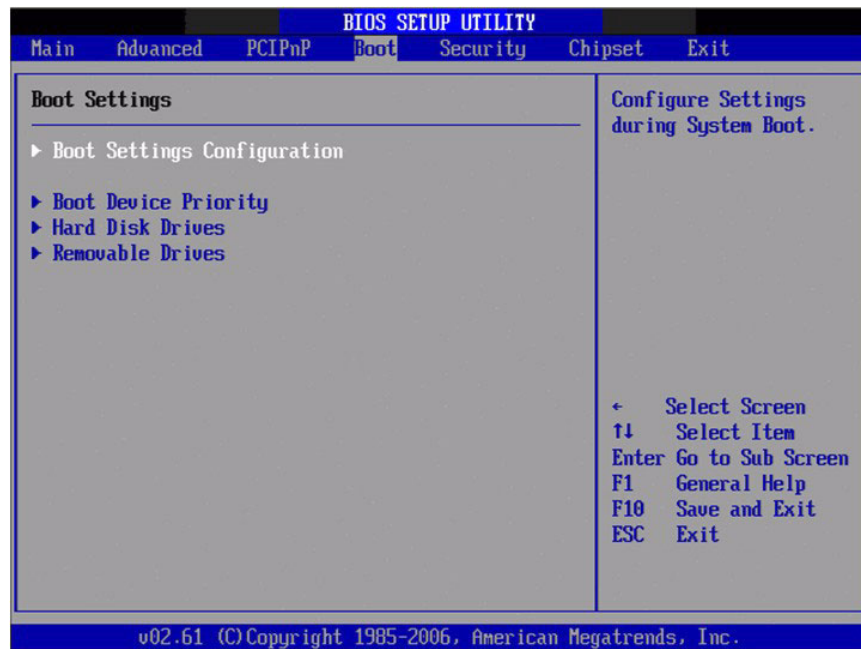

Figure 3.19 Boot Setup Utility

### 3.6.1 Boot Settings Configuration

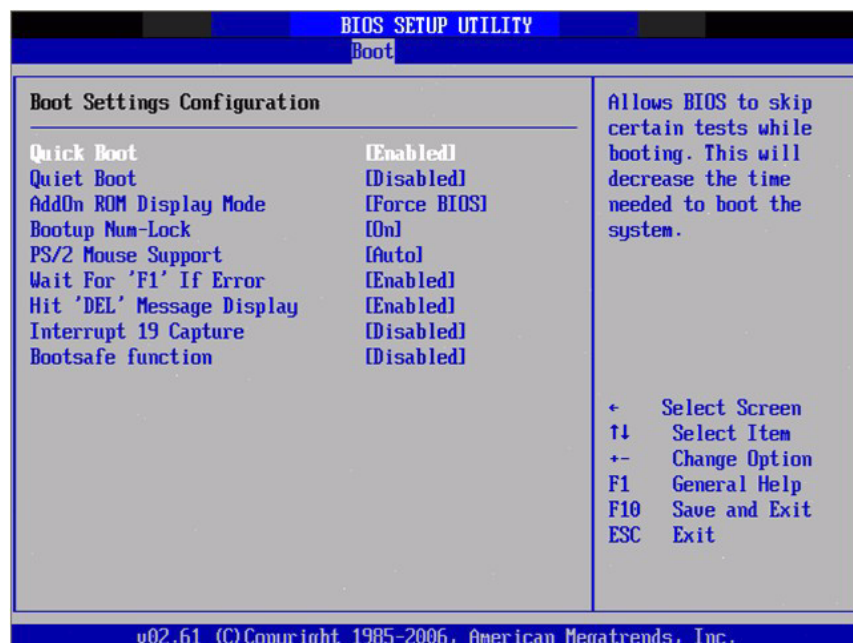

Figure 3.20 Boot Setting Configuration



- **Quick Boot**  
This item allows BIOS to skip certain tests while booting. This will decrease the time needed to boot the system.
- **Quiet Boot**  
If this option is set to Disabled, BIOS displays normal POST messages. If Enabled, an OEM Logo is shown instead of POST messages.
- **AddOn ROM Display Mode**  
Set display mode for option ROM.
- **Bootup Num-Lock**  
Select the Power-on state for Numlock.
- **PS/2 Mouse Support**  
Select support for PS/2 Mouse.
- **Wait For "F1" If Error**  
Wait for the F1 key to be pressed if an error occurs.
- **Hit "DEL" Message Display**  
Displays "Press DEL to run Setup" in POST.
- **Interrupt 19 Capture**  
This item allows option ROMs to trap interrupt 19.
- **Bootsafe function**  
This item allows you to enable or disable bootsafe function.

## 3.7 Security Setup



**Figure 3.21 Password Configuration**

Select Security Setup from the ARK-3403 Setup main BIOS setup menu. All Security Setup options, such as password protection and virus protection, are described in this section. To access the sub menu for the following items, select the item and press <Enter>:

- **Change Supervisor / User Password**

Boot sector Virus protection: The boot sector virus protection will warn if any program tries to write to the boot sector.

## 3.8 Advanced Chipset Settings



Figure 3.22 Advanced Chipset Settings

### 3.8.1 North Bridge Configuration



Figure 3.23 North Bridge Configuration



- **DRAM Frequency**  
This item allows you to manually change DRAM frequency.
- **Configure DRAM Timing by SPD**  
This item allows you to enable or disable detect by DRAM SPD.
- **Memory Hole**  
This item allows you to free 15MB-16MB of memory size for some ISA devices.
- **Initiate Graphic Adapter**  
This item allows you to select which graphics controller to use as the primary boot device.  
Internal Graphics Mode Select: Select the amount of system memory used by the internal graphics device.

### 3.8.1.1 Video Function Configuration

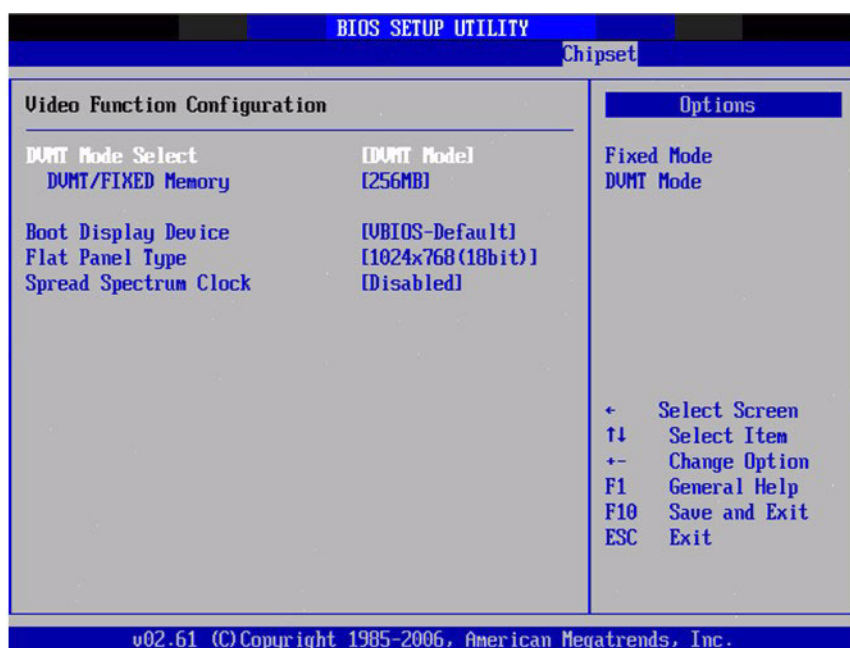

Figure 3.24 Video function configuration

- **DVMT Mode Select**  
Displays the active system memory mode.
- **DVMT/FIXED Memory**  
Specify the amount of DVMT / FIXED system memory to allocate for video memory.
- **Boot Display Device**  
Select boot display device at post stage.
- **Flat Panel Type**  
This item allows you to select panel resolution.
- **Spread Spectrum Clock**  
This item allows you to enable or disable spread spectrum clock.

## 3.8.2 South Bridge Chipset Configuration

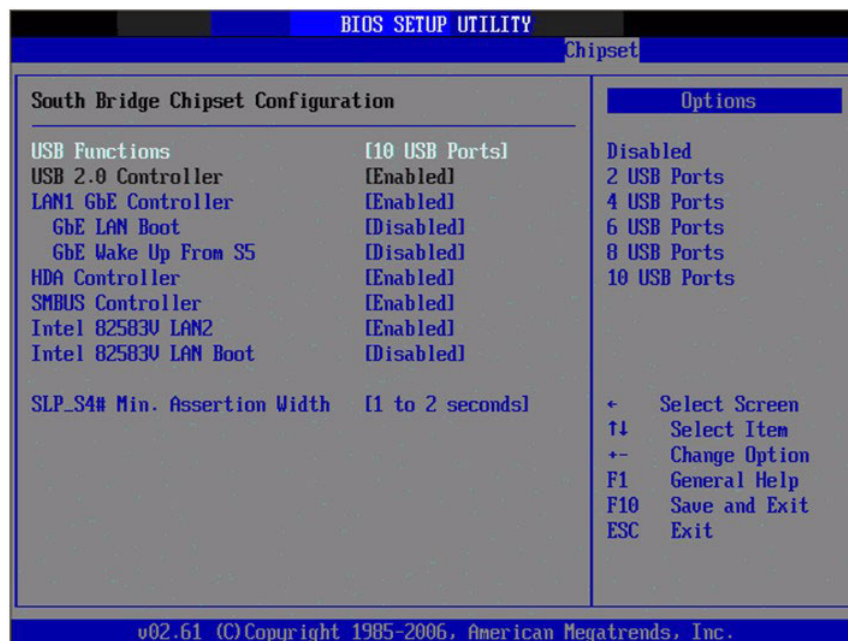

Figure 3.25 South Bridge Configuration

- **USB Functions**  
Disabled, 2 USB Ports, 4 USB Ports, 6 USB Ports or 8 USB Ports.
- **USB 2.0 Controller**  
Enables or disables the USB 2.0 controller.
- **LAN1 GbE controller**  
Enables or disables the GbE controller.
- **GbE LAN Boot**  
Enables or disables GbE LAN boot.
- **GbE Wake Up From S5**  
Enables or disables GbE LAN wake up from S5 function.
- **HDA Controller**  
Enables or disables the HDA controller.
- **SMBUS Controller**  
Enables or disables the SMBUS controller.
- **Intel 82583V LAN2**  
Enables or disables the LAN2 controller.
- **Intel 82583V LAN Boot**  
Enables or disables Intel 82583V LAN boot.
- **SLP\_S4# Min. Assertion Width**  
This item allows you to set a minimum assertion width of the SLP-S4# signal to guarantee that memory has been safely power-cycled.

## 3.9 Exit Option

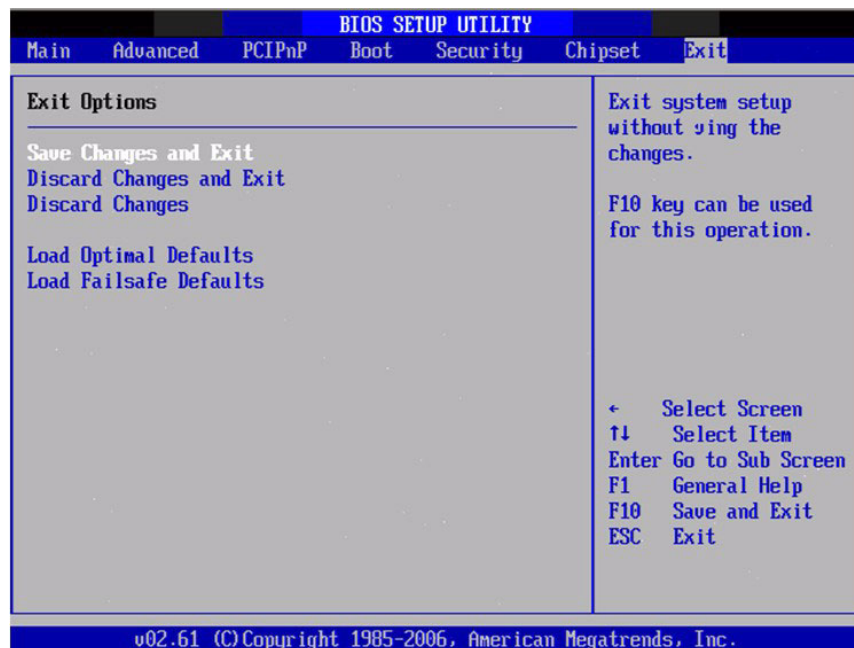

Figure 3.26 Exit Option

### 3.9.1 Save Changes and Exit

When you have completed system configuration, select this option to save your changes, exit BIOS setup and reboot the computer so the new system configuration parameters can take effect.

1. Select Exit Saving Changes from the Exit menu and press <Enter>. The following message appears: Save Configuration Changes and Exit Now? [Ok] [Cancel].
2. Select Ok or cancel.

### 3.9.2 Discard Changes and Exit

Select this option to quit Setup without making any permanent changes to the system configuration.

1. Select Exit Discarding Changes from the Exit menu and press <Enter>. The following message appears: Discard Changes and Exit Setup Now? [Ok] [Cancel]
2. Select Ok to discard changes and exit. Discard Changes
3. Select Discard Changes from the Exit menu and press <Enter>.

### 3.9.3 Load Optimal Defaults

The ARK-3403 automatically configures all setup items to optimal settings when you select this option. Optimal Defaults are designed for maximum system performance, but may not work best for all computer applications. In particular, do not use the Optimal Defaults if your computer is experiencing system configuration problems. Select Load Optimal Defaults from the Exit menu and press <Enter>.

---

### 3.9.4 Load Fail-Safe Defaults

The ARK-3403 automatically configures all setup options to fail-safe settings when you select this option. Fail-Safe Defaults are designed for maximum system stability, but not maximum performance. Select Fail-Safe Defaults if your computer is experiencing system configuration problems.

1. Select Load Fail-Safe Defaults from the Exit menu and press <Enter>. The following message appears: Load Fail-Safe Defaults? [OK] [Cancel].
2. Select OK to load Fail-Safe defaults.

# Chapter 4

## Software installation

This chapter introduces driver installation.

## 4.1 Driver Installation

### 4.1.1 Chipset driver installation

1. Change folder address to \Driver\00-PCH. And double click to execute infinst\_autol.exe.

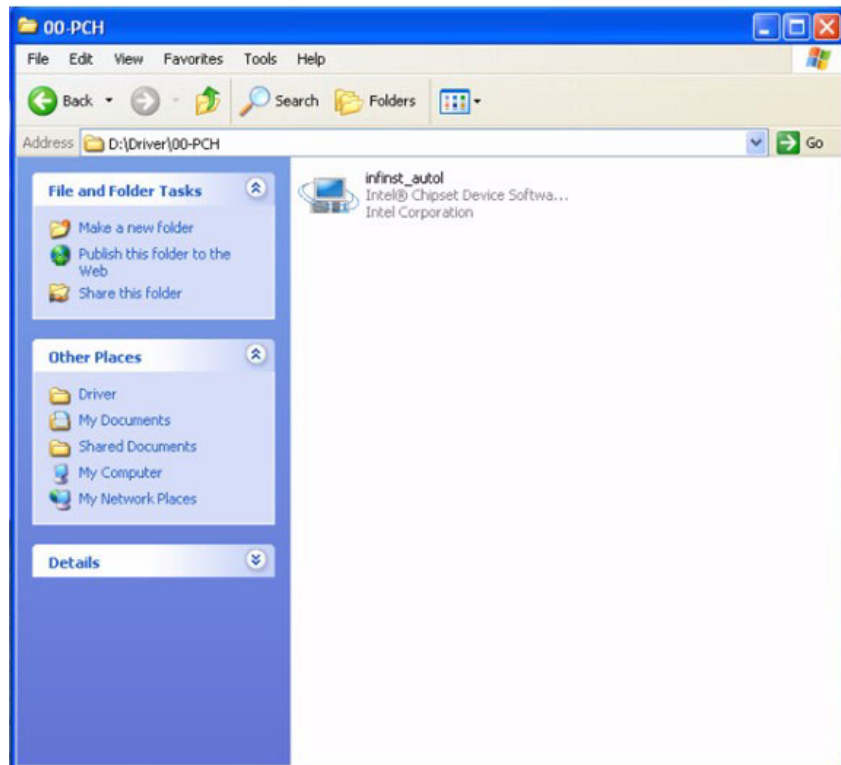

2. Click "Next" button to go to the next step.



3. Click "Yes" to accept License Agreement.



4. Click "Next" to exit Readme File Information window.





5. Select “Yes, I want to restart this computer now.” and click “Finish” bottom. The computer will restart automatically. Then the driver installation is complete.



#### 4.1.2 Graphic driver installation

1. Change folder address to \Driver\01-Graphic. And double click to execute setup.exe.

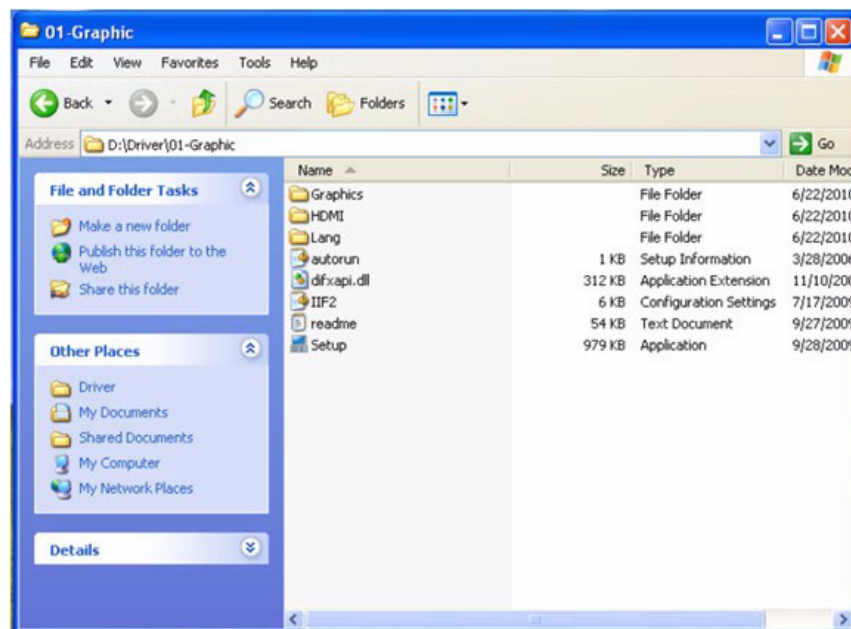



2. Click "Next" button to skip through welcome window.



3. Click "Yes" to accept License Agreement.



- Click “Next” to exit Readme File Information window.

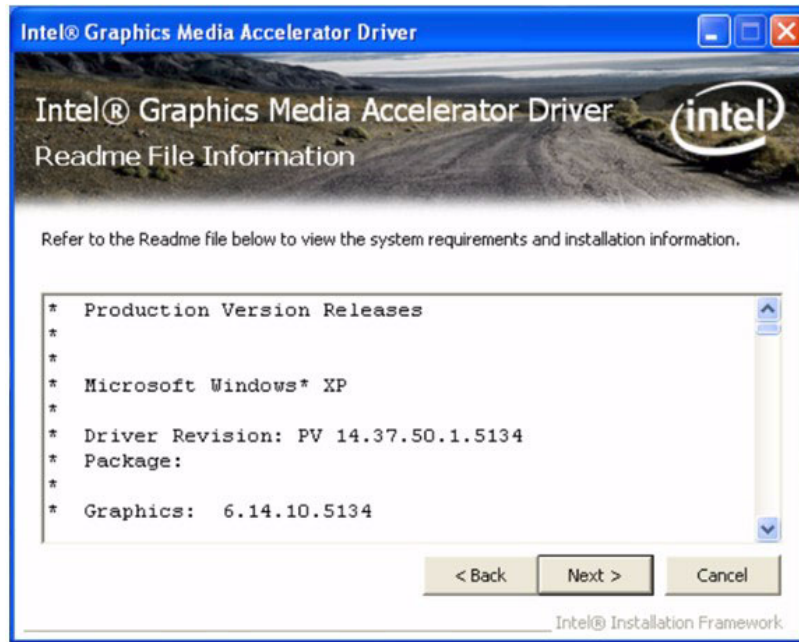

- Click “Next” button to continue.

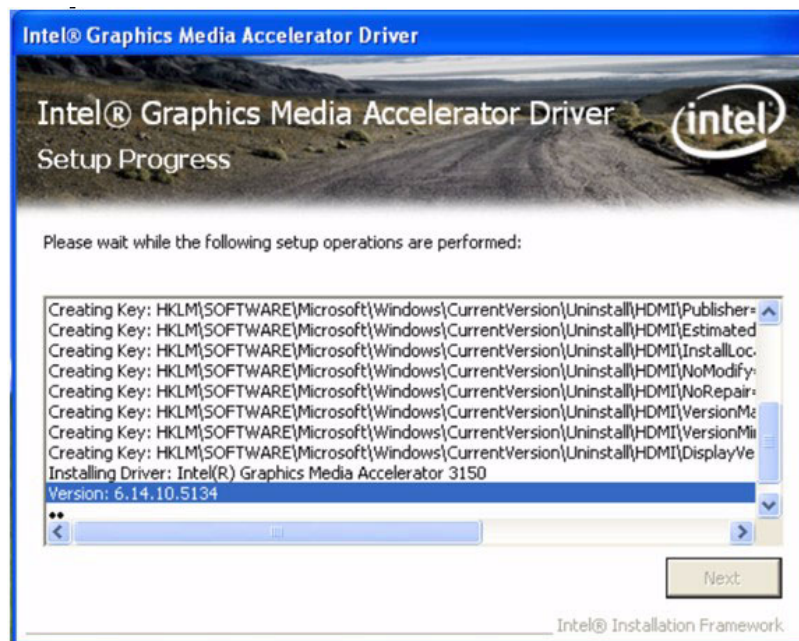

6. Select “Yes, I want to restart this computer now.” and click “Finish” button. The computer will restart automatically. Then the driver installation is completed.



### 4.1.3 Audio driver installation

1. Change folder address to \Driver\02-Audio. And double click to execute WDM\_R192.exe.

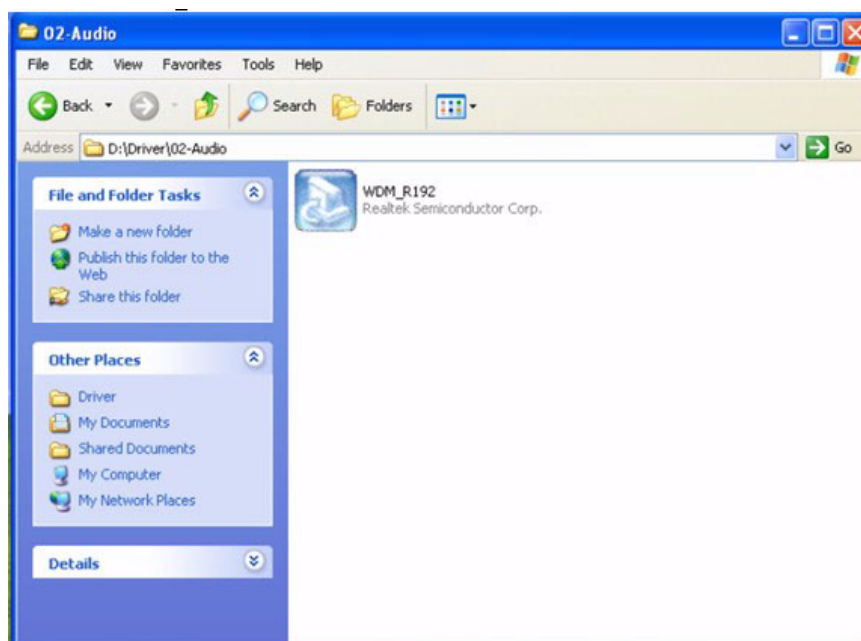

2. Click “Next” button to skip welcome message.

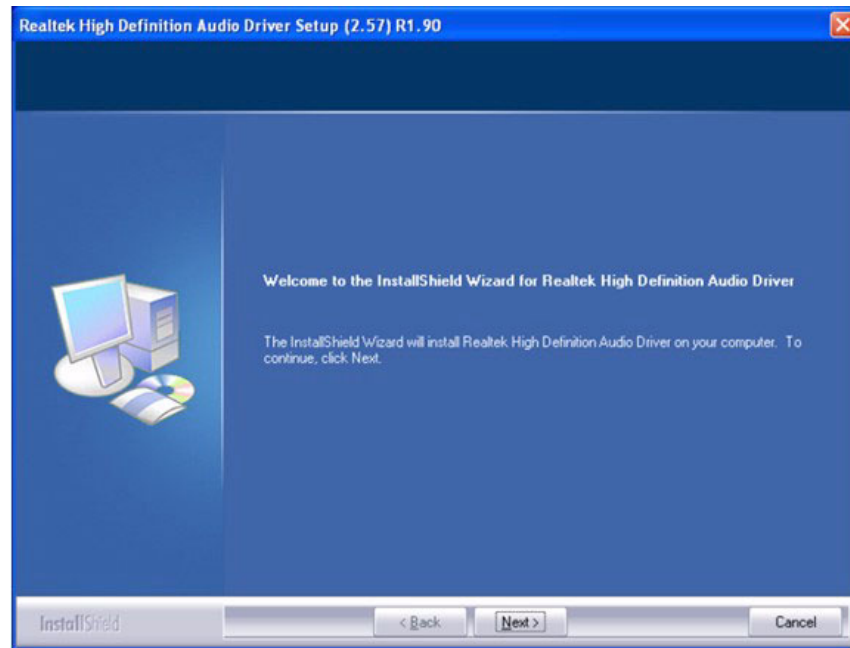

3. Select “Yes, I want to restart this computer now.” and click “Finish” button. The computer will restart automatically. Then the driver installation is completed.

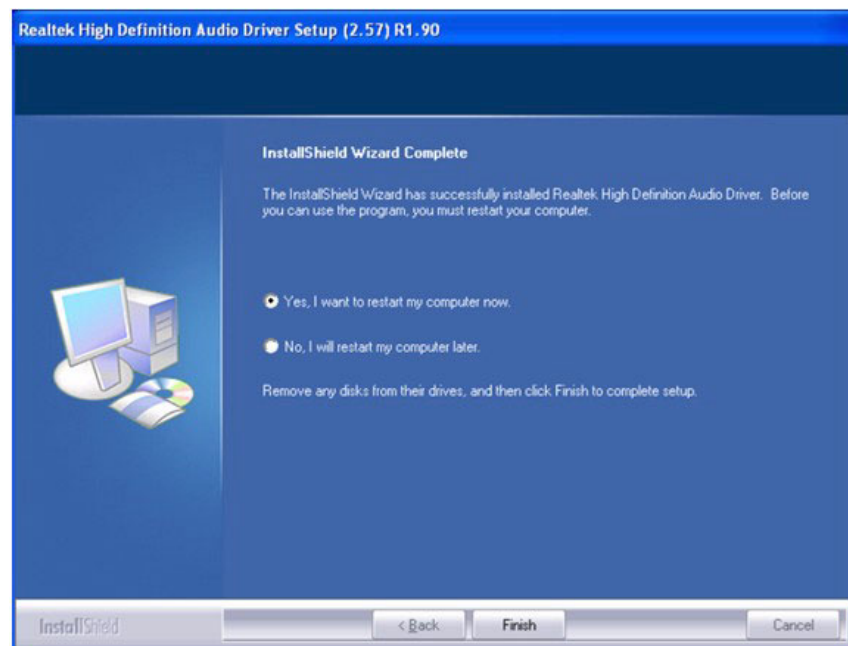

### 4.1.4 LAN driver installation

1. Change folder address to \Driver\03-LAN. And double click to execute Autorun.exe.

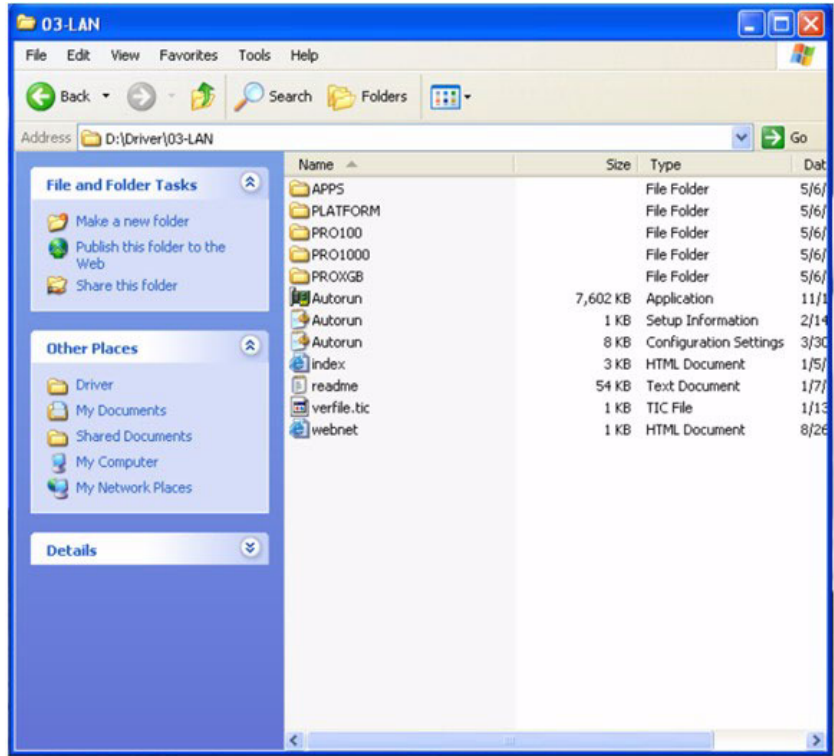

2. Select "Install Drivers and Software".

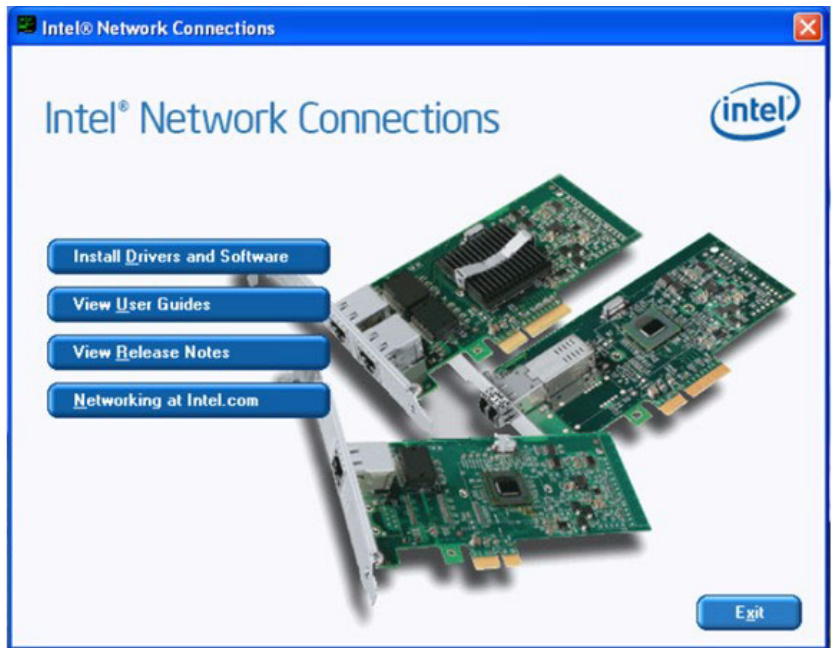



3. Click “Next” button to go to the next step.



4. Select “I accept the terms in the license agreement”, and click “Next” button.



5. Select Drivers > Intel® PROSet for Windows® Device Manager > Advanced Networks Services [by default setting]. And click “Next” button to go to the next step.

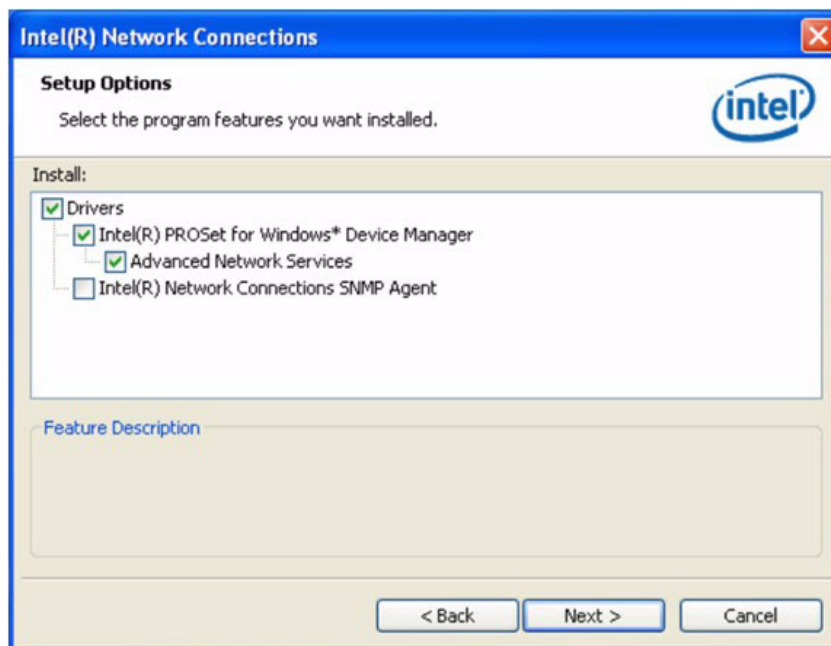

6. Click “Install” button to start Installation.

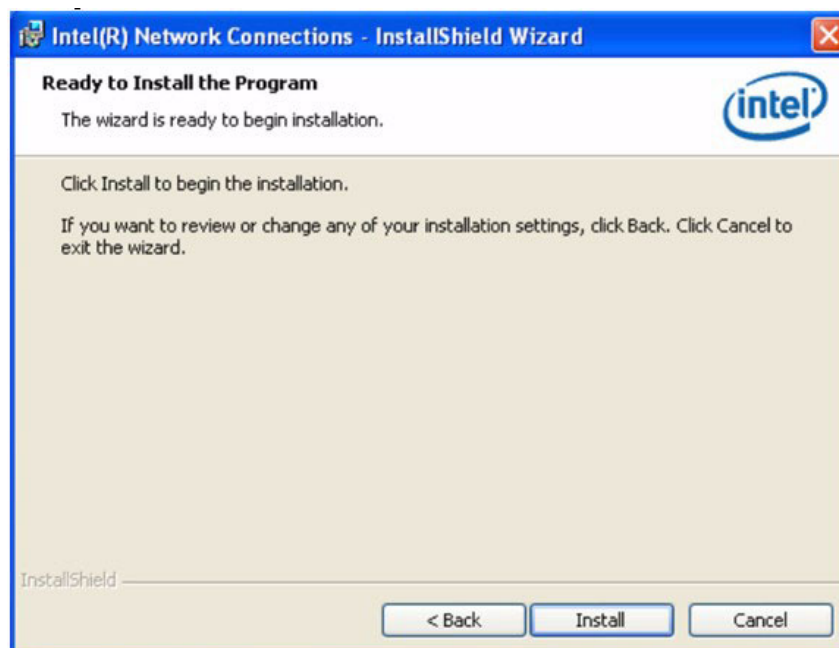

7. The network driver installation is complete. Click “Finish” button to exit InstallShield.

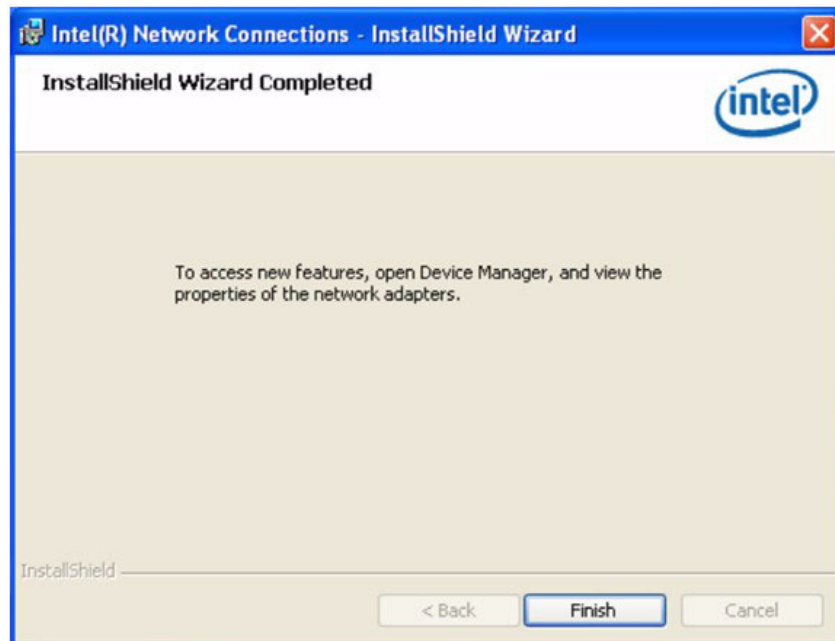



# Appendix **A**

## Function Settings

## A.1 Function Settings

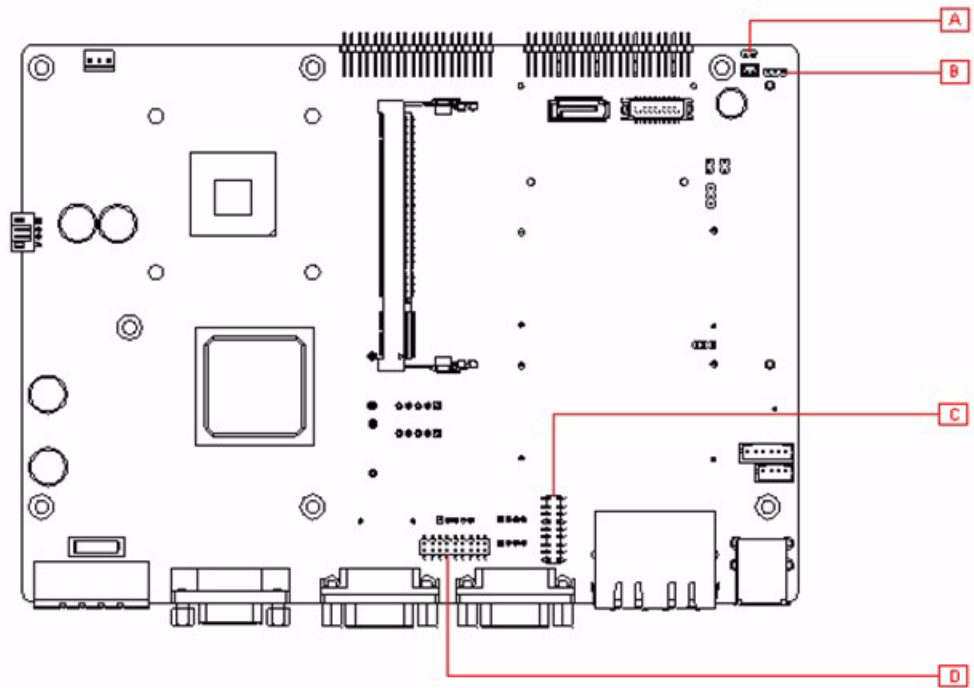

Figure A.1 Top View

### A

Table A.1: ATX / AT Mode switch

JP1	ATX / AT Mode switch
Footprint	2x1 Pin
Setting	Function
(1-2)	AT
Empty	ATX Mode (default)

### B

Table A.2: Clear CMOS

JP2	Clear CMOS
Footprint	3x1 Pin
Setting	Function
(1-2)	Normal (default)
(2-3)	Clear CMOS

**CD**

Table A.3: COM1 / COM2 RS232/422/485 select	
CN17 / CN11	RS232/422/485 select
Footprint	9x2 Pin
Setting	Function
(5-6),(7-9),(8-10),(13-15),(14-16)	RS232
(3-4),(9-11),(10-12),(15-17),(16-18)	RS422
(1-2),(9-11),(10-12),(15-17),(16-18)	RS485

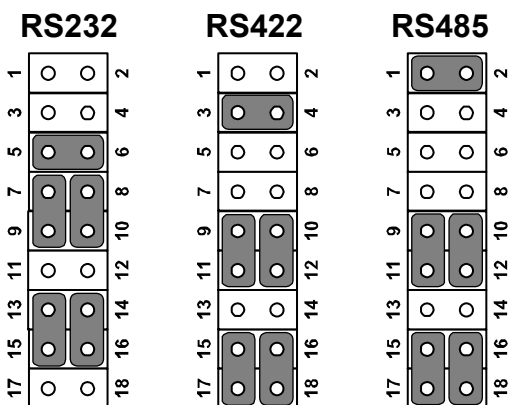



# Appendix **B**

Application Notes

---

## B.1 WOL Setting

### B.1.1 Introduction

Wake on LAN (WOL, sometimes WoL) is an Ethernet computer networking standard that allows a computer to be turned on or awakened remotely by a network message.

### B.1.2 System requirements - PC Compatible

Wake on LAN (WoL) support is implemented on the motherboard of a computer. Most modern motherboards with an embedded Ethernet controller support WoL without the need for an external cable. Older motherboards must have a WAKEUP-LINK header onboard and connected to the network card via a special 3-pin cable; however, systems supporting the PCI 2.2 standard coupled with a PCI 2.2 compliant network adapter typically do not require a WoL cable as the required standby power is relayed through the PCI bus.

PCI version 2.2 has PME (Power Management Events). What this means is that PCI cards can send and receive PME via the PCI socket directly, without the need for a WOL cable.

Laptops powered by the Intel 3945 chipset or newer (with explicit BIOS support) allow waking up the machine using wireless (802.11 protocols). This is called Wake on Wireless LAN (WoWLAN).

Wake on LAN must be enabled in the Power Management section of the motherboard's BIOS. It may also be necessary to configure the computer to reserve power for the network card when the system is shutdown.

In addition, in order to get WOL to work it is sometimes required to enable this feature on the card. This can be done in Microsoft Windows from the properties of the network card in the device manager, on the "Power Management" tab. Check "Allow this device to bring the computer out of standby" and then "Only allow management stations to bring the computer out of standby" to make sure it does not wake up on all network activity.

### B.1.3 How it works

Wake-on-LAN is not restricted to LAN (Local area network) traffic.

The general process of waking a computer up remotely over a network connection can be explained thusly:

The target computer is shut down (Sleeping, Hibernating or Soft Off, i.e. ACPI state G1 or G2), with power reserved for the network card. The network card listens for a specific packet, called the "Magic Packet." The Magic Packet is broadcast on the broadcast address for that particular subnet (or an entire LAN, though this requires special hardware and/or configuration). When the listening computer receives this packet, the network card checks the packet for the correct information. If the Magic Packet is valid, the network card turns on the computer to full power and boots the operating system.

The magic packet is sent on the data link or OSI-2 layer and broadcast to all NICs (within the network of the broadcast address). Therefore, it does not matter whether the remote host has a fixed or dynamic IP-address (OSI-3 layer).

In order for Wake on LAN to work, parts of the network interface need to stay on. This increases the standby power used by the computer. If Wake on LAN is not needed, turning it off may reduce power consumption while the computer is off but still plugged in.

### B.1.4 Magic Packet

The Magic Packet is a broadcast frame containing anywhere within its payload 6 bytes of ones (resulting in hexadecimal FF FF FF FF FF FF) followed by sixteen repetitions of the target computer's MAC address.

Since the Magic Packet is only scanned for the string above, and not actually parsed by a full protocol stack, it may be sent as a broadcast packet of any network- and transport-layer protocol. It is typically sent as a UDP datagram to port 0, 7 or 9, or, in former times, as an IPX packet.

*Trusted ePlatform Services*

**ADVANTECH**

[www.advantech.com.cn](http://www.advantech.com.cn)

Please verify specifications before quoting. This guide is intended for reference purposes only.

All product specifications are subject to change without notice.

No part of this publication may be reproduced in any form or by any means, electronic, photocopying, recording or otherwise, without prior written permission of the publisher.

All brand and product names are trademarks or registered trademarks of their respective companies.

© Advantech Co., Ltd. 2010