

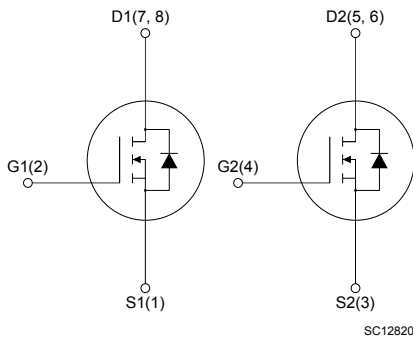

Automotive-grade dual N-channel 60 V, 21 mΩ typ., 8 A STripFET F6 Power MOSFET in a SO-8 package

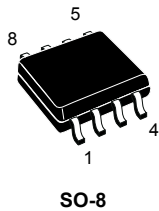

Features

Order code	V_{DS}	$R_{DS(on)}$ max.	I_D	P_{TOT}
STS8DN6LF6AG	60 V	24 mΩ	8 A	3.2 W

- AEC-Q101 qualified 
- Very low on-resistance
- Very low gate charge
- High avalanche ruggedness
- Low gate drive power loss
- Logic level

Applications

- Switching applications

Description

This device is a dual N-channel Power MOSFET developed using the STripFET F6 technology with a new trench gate structure. The resulting Power MOSFET exhibits very low $R_{DS(on)}$ in all packages.



Product status link

[STS8DN6LF6AG](#)

Product summary

Order code	STS8DN6LF6AG
Marking	8DN6LF6
Package	SO-8
Packing	Tape and reel

1 Electrical ratings

Table 1. Absolute maximum ratings

Symbol	Parameter	Value	Unit
V_{DS}	Drain-source voltage	60	V
V_{GS}	Gate-source voltage	± 20	V
$I_D^{(1)}$	Drain current (continuous) at $T_{amb} = 25\text{ }^\circ\text{C}$	8	A
	Drain current (continuous) at $T_{amb} = 100\text{ }^\circ\text{C}$	5.8	
$I_{DM}^{(2)}$	Drain current (pulsed)	32	A
P_{TOT}	Total power dissipation at $T_{amb} = 25\text{ }^\circ\text{C}$ (one channel active)	3.2	W
T_{stg}	Storage temperature range	-55 to 175	$^\circ\text{C}$
T_J	Operating junction temperature range		$^\circ\text{C}$

1. When mounted on a 1-inch² FR-4, 2 Oz copper board, $t < 10\text{ s}$.
2. Pulse width is limited by safe operating area.

Table 2. Thermal data

Symbol	Parameter	Value	Unit
$R_{thJA}^{(1)}$	Thermal resistance, junction-to-ambient	47	$^\circ\text{C}/\text{W}$

1. When mounted on a 1-inch² FR-4, 2 Oz copper board, $t < 10\text{ s}$.

Table 3. Avalanche characteristics

Symbol	Parameter	Value	Unit
I_{AV}	Avalanche current, not repetitive	6	A
$E_{AS}^{(1)}$	Single pulse avalanche energy	72	mJ

1. Starting $T_J = 25\text{ }^\circ\text{C}$, $I_D = I_{AV}$, $V_{DD} = 43.5\text{ V}$.

2 Electrical characteristics

$T_C = 25\text{ }^\circ\text{C}$ unless otherwise specified.

Table 4. Static

Symbol	Parameter	Test conditions	Min.	Typ.	Max.	Unit
$V_{(BR)DSS}$	Drain-source breakdown voltage	$V_{GS} = 0\text{ V}$, $I_D = 250\text{ }\mu\text{A}$	60			V
I_{DSS}	Zero gate voltage drain current	$V_{GS} = 0\text{ V}$, $V_{DS} = 60\text{ V}$			1	μA
I_{GSS}	Gate-body leakage current	$V_{DS} = 0\text{ V}$, $V_{GS} = \pm 20\text{ V}$			± 100	nA
$V_{GS(th)}$	Gate threshold voltage	$V_{DS} = V_{GS}$, $I_D = 250\text{ }\mu\text{A}$	1		2.5	V
$R_{DS(on)}$	Static drain-source on-resistance	$V_{GS} = 10\text{ V}$, $I_D = 4\text{ A}$		21	24	m Ω
		$V_{GS} = 4.5\text{ V}$, $I_D = 4\text{ A}$		22	26	

Table 5. Dynamic

Symbol	Parameter	Test conditions	Min.	Typ.	Max.	Unit
C_{iss}	Input capacitance	$V_{DS} = 25\text{ V}$, $f = 1\text{ MHz}$, $V_{GS} = 0\text{ V}$	-	1340	-	pF
C_{oss}	Output capacitance		-	90	-	pF
C_{rss}	Reverse transfer capacitance		-	60	-	pF
Q_g	Total gate charge	$V_{DD} = 30\text{ V}$, $I_D = 8\text{ A}$, $V_{GS} = 10\text{ V}$ (see Figure 13. Test circuit for gate charge behavior)	-	27	-	nC
Q_{gs}	Gate-source charge		-	4.6	-	nC
Q_{gd}	Gate-drain charge		-	4.3	-	nC

Table 6. Switching times

Symbol	Parameter	Test conditions	Min.	Typ.	Max.	Unit
$t_{d(on)}$	Turn-on delay time	$V_{DD} = 30\text{ V}$, $I_D = 4\text{ A}$, $R_G = 4.7\text{ }\Omega$, $V_{GS} = 10\text{ V}$	-	9.6	-	ns
t_r	Rise time		-	20	-	ns
$t_{d(off)}$	Turn-off delay time	(see Figure 12. Test circuit for resistive load switching times and Figure 17. Switching time waveform)	-	56	-	ns
t_f	Fall time		-	7	-	ns

Table 7. Source-drain diode

Symbol	Parameter	Test conditions	Min.	Typ.	Max.	Unit
I_{SD}	Source-drain current		-		8	A
$I_{SDM}^{(1)}$	Source-drain current (pulsed)		-		32	A
$V_{SD}^{(2)}$	Forward on voltage	$V_{GS} = 0\text{ V}$, $I_{SD} = 8\text{ A}$	-		1.3	V
t_{rr}	Reverse recovery time	$I_{SD} = 8\text{ A}$, $di/dt = 100\text{ A}/\mu\text{s}$,	-	22.5		ns
Q_{rr}	Reverse recovery charge	$V_{DD} = 48\text{ V}$, $T_J = 25\text{ }^\circ\text{C}$	-	22.2		nC
I_{RRM}	Reverse recovery current	(see Figure 14. Test circuit for inductive load switching and diode recovery times)	-	2.0		A

1. Pulse width is limited by safe operating area.
2. Pulse test: pulse duration = 300 μs , duty cycle 1.5%.

2.1 Electrical characteristics (curves)

Figure 1. Safe operating area

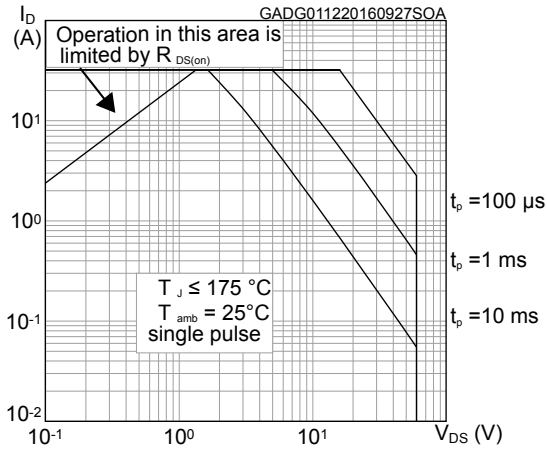

Figure 2. Thermal impedance

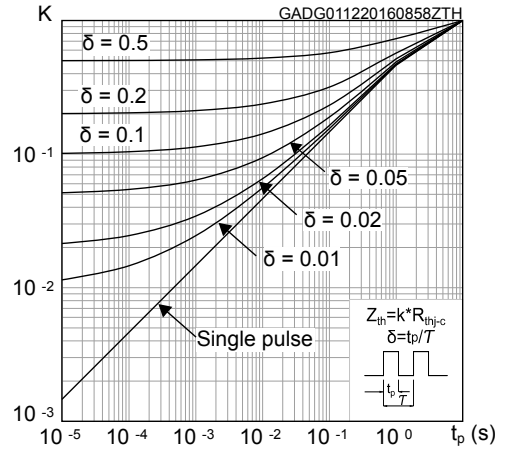

Figure 3. Output characteristics

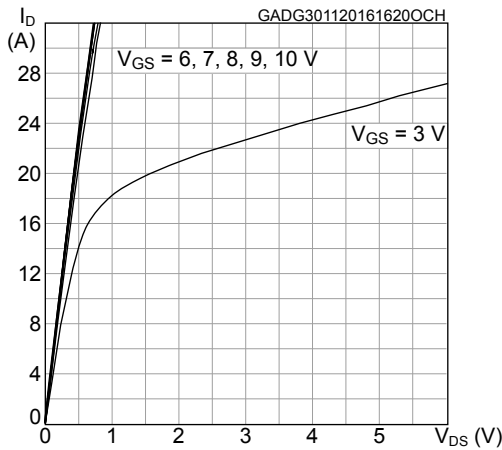

Figure 4. Transfer characteristics

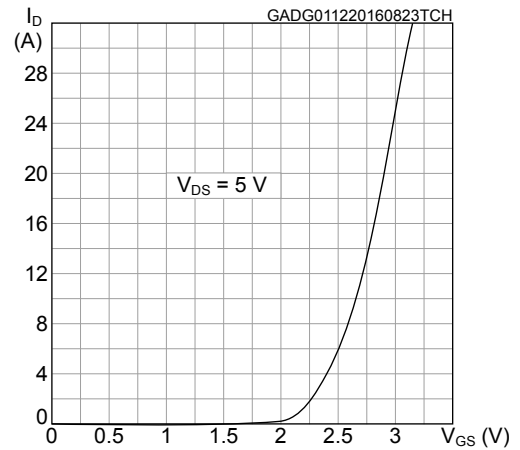

Figure 5. Gate charge vs gate-source voltage

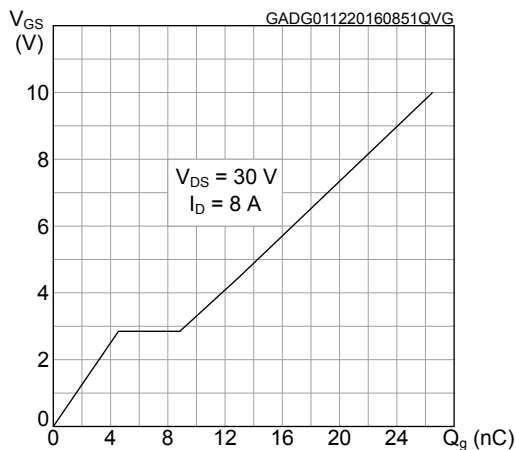

Figure 6. Static drain-source on-resistance

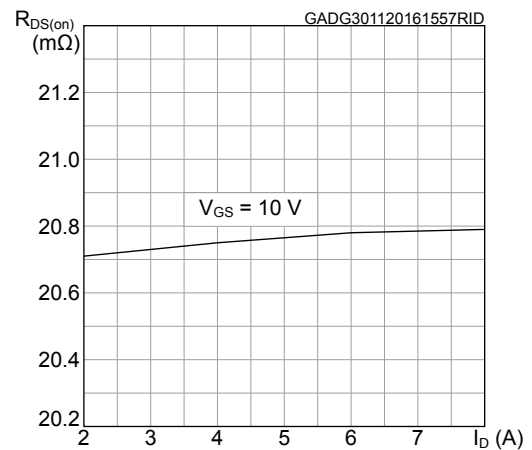

Figure 7. Capacitance variations

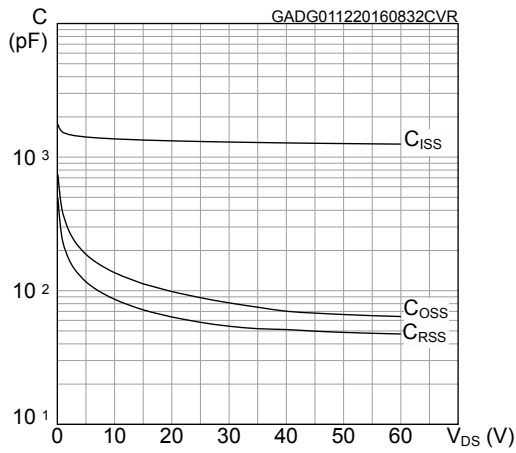

Figure 8. Normalized gate threshold voltage vs temperature

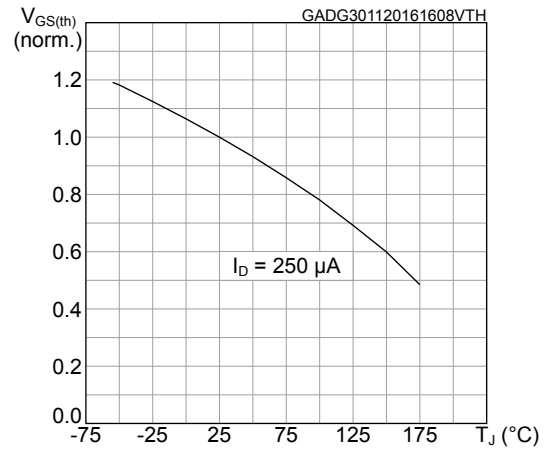

Figure 9. Normalized on-resistance vs temperature

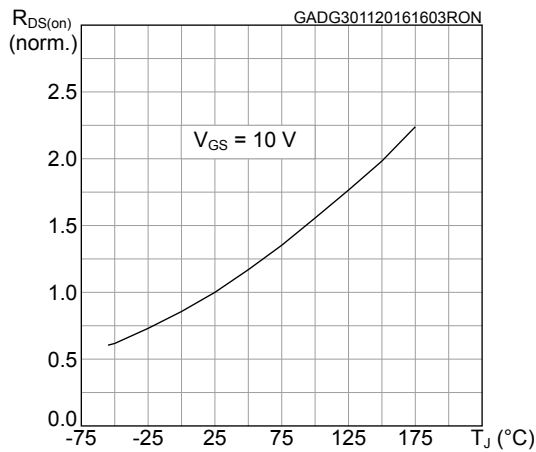

Figure 10. Normalized V_(BR)DSS vs temperature

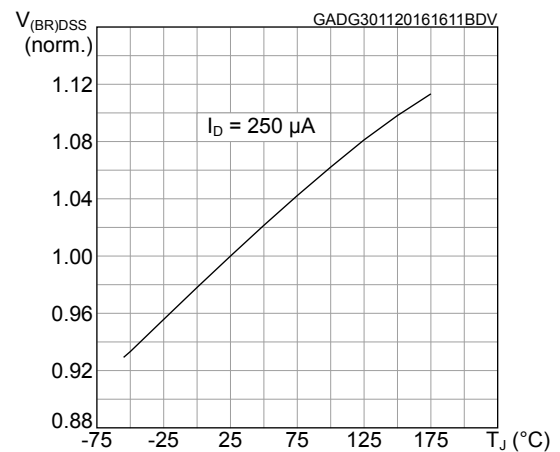
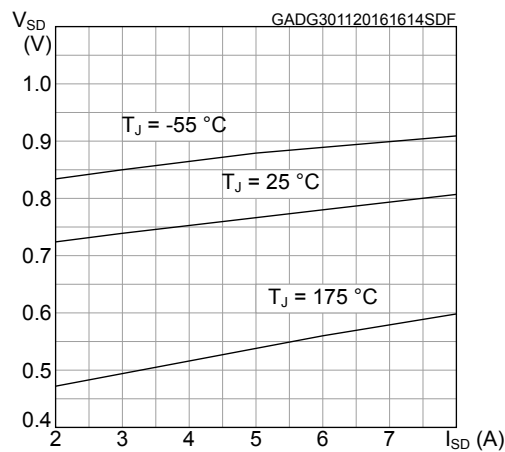
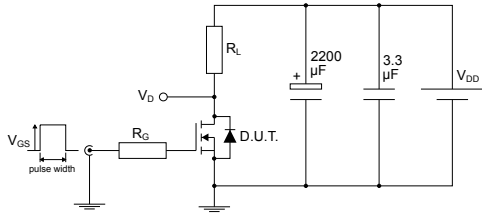

Figure 11. Source-drain diode forward characteristics



3 Test circuits

Figure 12. Test circuit for resistive load switching times



AM01468v1

Figure 13. Test circuit for gate charge behavior

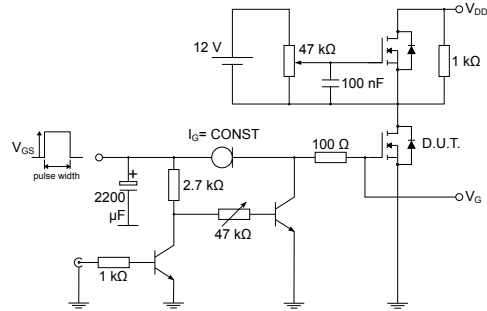

AM01469v1

Figure 14. Test circuit for inductive load switching and diode recovery times

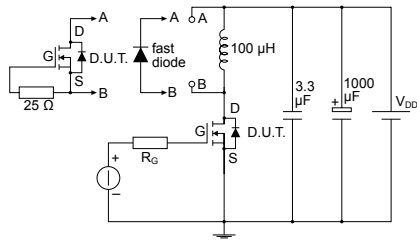

AM01470v1

Figure 15. Unclamped inductive load test circuit

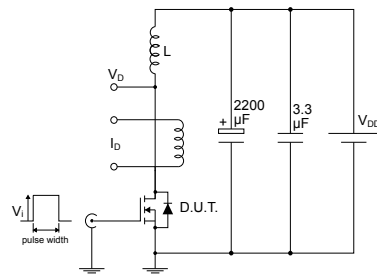

AM01471v1

Figure 16. Unclamped inductive waveform

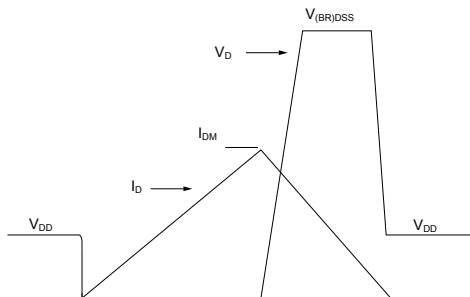

AM01472v1

Figure 17. Switching time waveform

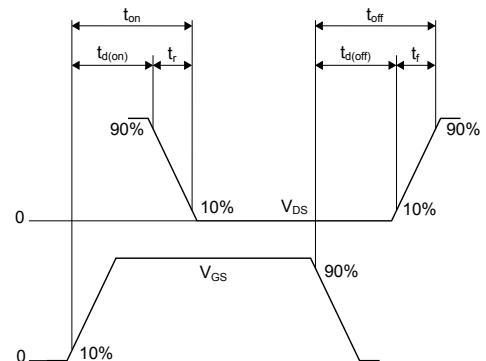

AM01473v1

4 Package information

In order to meet environmental requirements, ST offers these devices in different grades of **ECOPACK** packages, depending on their level of environmental compliance. ECOPACK specifications, grade definitions and product status are available at: www.st.com. ECOPACK is an ST trademark.

4.1 SO-8 package information

Figure 18. SO-8 package outline

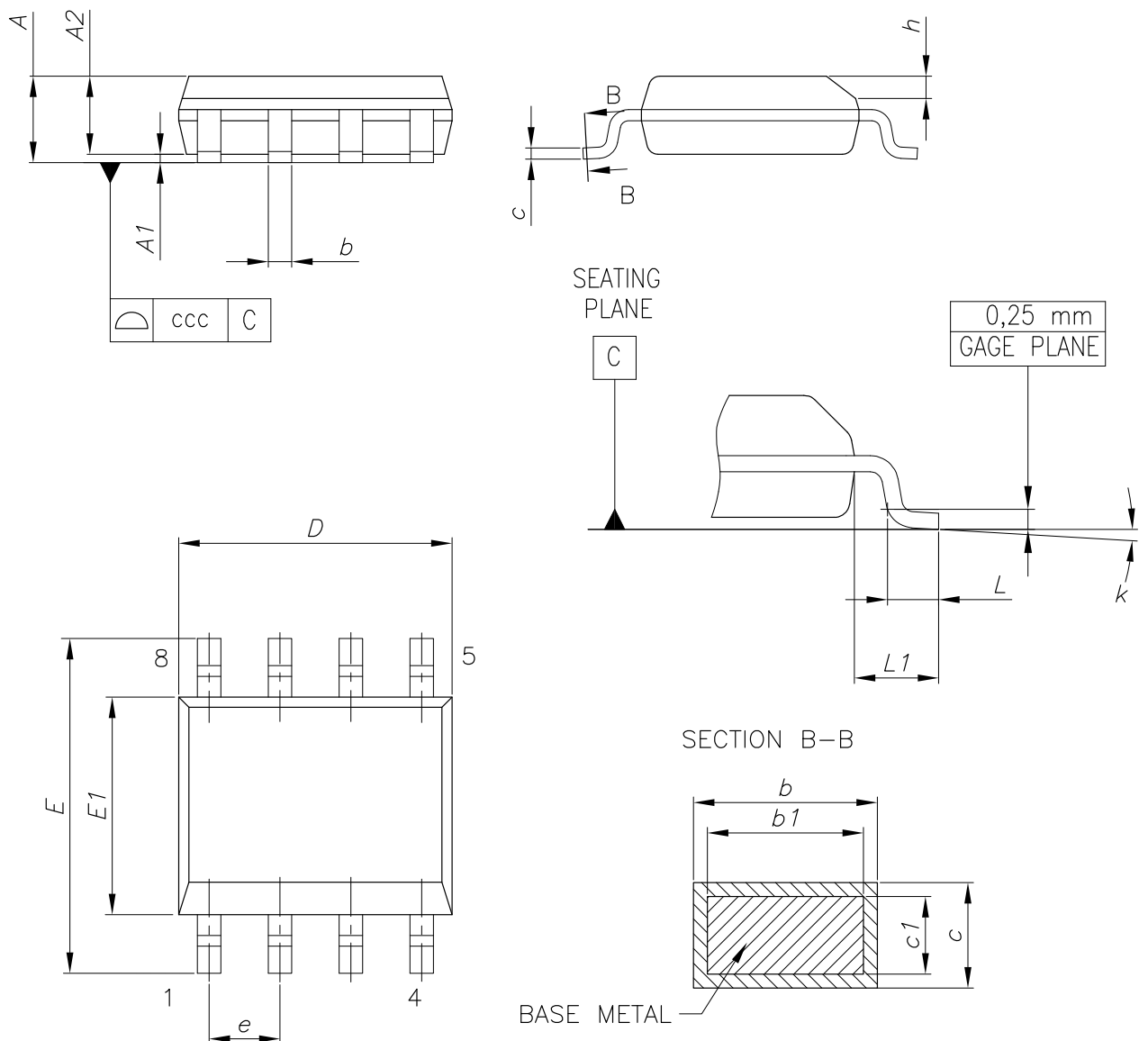

0016023_So-807_fig2_Rev10

Table 8. SO-8 mechanical data

Dim.	mm		
	Min.	Typ.	Max.
A			1.75
A1	0.10		0.25
A2	1.25		
b	0.31		0.51
b1	0.28		0.48
c	0.10		0.25
c1	0.10		0.23
D	4.80	4.90	5.00
E	5.80	6.00	6.20
E1	3.80	3.90	4.00
e		1.27	
h	0.25		0.50
L	0.40		1.27
L1		1.04	
L2		0.25	
k	0°		8°
ccc			0.10

Figure 19. SO-8 recommended footprint (dimensions are in mm)

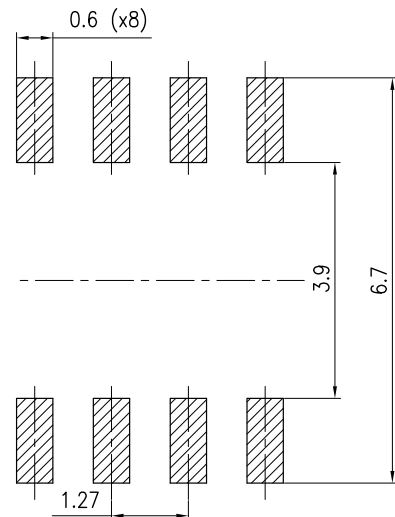

0016023_So-807_footprint_Rev10

4.2 SO-8 packing information

Figure 20. SO-8 tape and reel dimensions

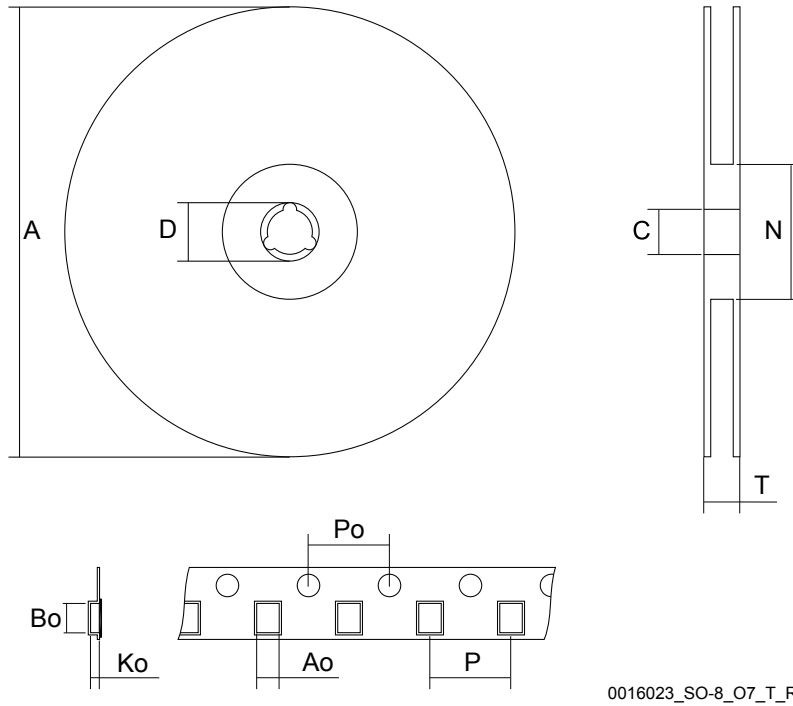

Figure 21. Tape orientation

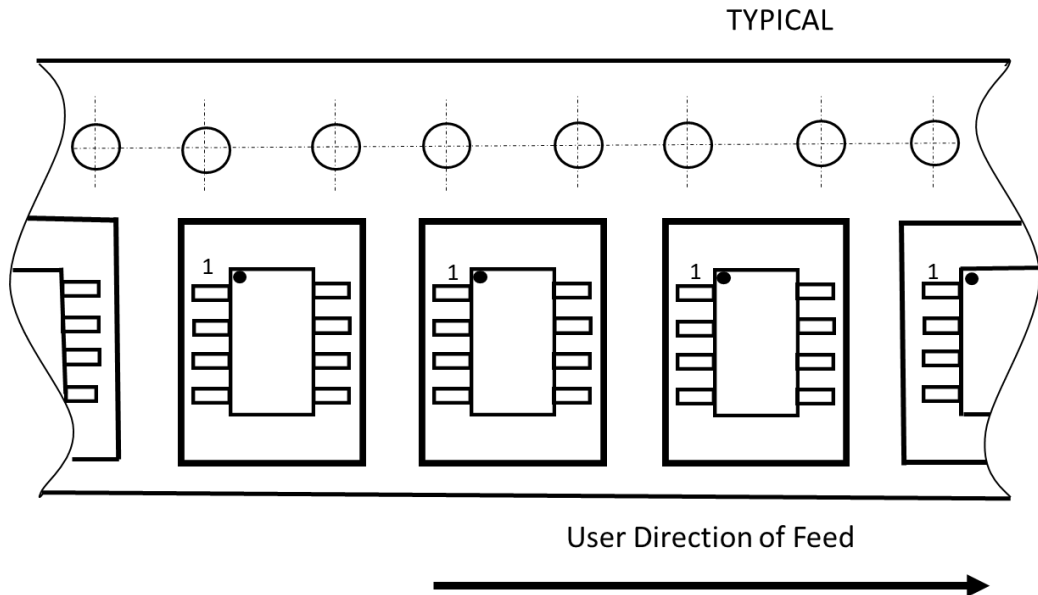

Table 9. SO-8 tape and reel mechanical data

Dim.	mm		
	Min.	Typ.	Max.
A			330
C	12.8		13.2
D	20.2		
N	60		
T			22.4
Ao	6.5	-	6.7
Bo	5.4		5.6
Ko	2.0		2.2
Po	3.9		4.1
P	7.9		8.1

Revision history

Table 10. Document revision history

Date	Version	Changes
01-Dec-2016	1	First release
08-Mar-2021	2	Updated Internal schematic for SO-8 dual N-channel. Updated Section 4.2 SO-8 packing information. Minor text changes.

Contents

1	Electrical ratings	2
2	Electrical characteristics	3
2.1	Electrical characteristics (curves)	5
3	Test circuits	7
4	Package information	8
4.1	SO-8 package information	8
4.2	SO-8 packing information	10
	Revision history	12

IMPORTANT NOTICE – PLEASE READ CAREFULLY

STMicroelectronics NV and its subsidiaries (“ST”) reserve the right to make changes, corrections, enhancements, modifications, and improvements to ST products and/or to this document at any time without notice. Purchasers should obtain the latest relevant information on ST products before placing orders. ST products are sold pursuant to ST’s terms and conditions of sale in place at the time of order acknowledgement.

Purchasers are solely responsible for the choice, selection, and use of ST products and ST assumes no liability for application assistance or the design of Purchasers’ products.

No license, express or implied, to any intellectual property right is granted by ST herein.

Resale of ST products with provisions different from the information set forth herein shall void any warranty granted by ST for such product.

ST and the ST logo are trademarks of ST. For additional information about ST trademarks, please refer to www.st.com/trademarks. All other product or service names are the property of their respective owners.

Information in this document supersedes and replaces information previously supplied in any prior versions of this document.

© 2021 STMicroelectronics – All rights reserved