



Micro Commercial Components
 130 W Cochran St, Unit B
 Simi Valley, CA 93065
 USA
 Tel:818-701-4933

MD165A08D2
MD165A12D2
MD165A16D2
MD165A18D2

Features

- Lead Free Finish/RoHS Compliant (NOTE 1) ("P" Suffix designates RoHS Compliant. See ordering information)
- Blocking Voltage:800 to 1800V
- Heat transfer through aluminum oxide DBC ceramic isolated metal baseplate
- Glass passivated chip

Applications

- Non-controllable rectifiers for AC/AC converters
- Line rectifiers for transistorized AC motor controllers
- Field supply for DC motors

165 Amp
GLASS PASSIVATED
RECTIFIER DIODE
MODULES
800~1800 Volts

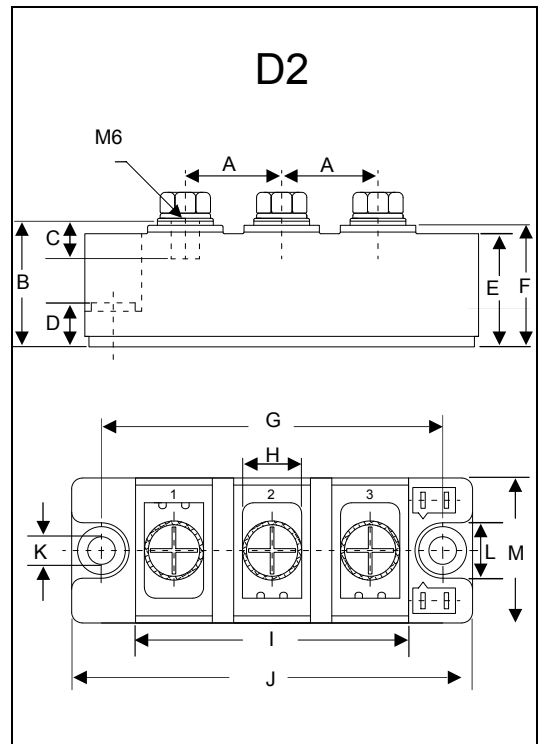

DIM	DIMENSIONS				NOTE
	INCHES		MM		
A	0.886	0.925	22.50	23.50	
B	1.161	1.201	29.50	30.50	
C	0.335	0.374	8.50	9.50	
D	0.315	0.350	8.00	8.90	
E	1.043	1.083	26.50	27.50	
F	1.122	1.161	28.50	29.50	
G	3.130	3.169	79.50	80.50	
H	0.492	0.531	12.50	13.50	
I	2.500	2.539	63.50	64.50	
J	3.681	3.720	93.50	94.50	
K	0.256		6.50		φ
L	0.492	0.531	12.50	13.50	
M	1.319	1.358	33.50	34.50	

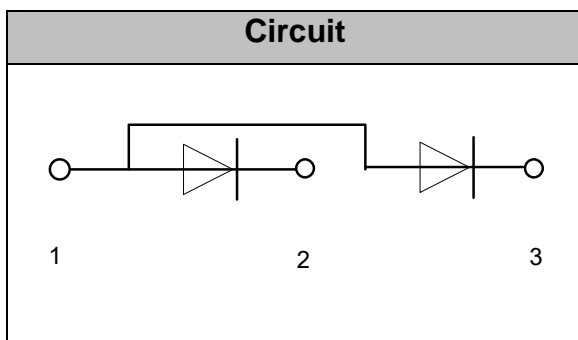

Module Type

TYPE	VRRM	VRSM
MD165A08D2	800V	900V
MD165A12D2	1200V	1300V
MD165A16D2	1600V	1700V
MD165A18D2	1800V	1900V

Maximum Ratings

Symbol	Conditions	Values	Units
IFAV	Single phase ,half wave 180° conduction Tc=101°C	165	A
IFSM	t=10mS Tvj =45°C	6000	A
i ² t	t=10mS Tvj =45°C	180000	A ² s
Visol	a.c.50HZ;r.m.s.;1min	3000	V
Tvj		-40 to +150	°C
Tstg		-40 to +125	°C
Mt	To terminals(M6)	5±15%	Nm
Ms	To heatsink(M6)	5±15%	Nm
Weight	Module (Approximately)	160	g

Thermal Characteristics

Symbol	Conditions	Values	Units
Rth(j-c)	Per diode	0.21	°C/W
Rth(c-s)	Module	0.05	°C/W

Electrical Characteristics

Symbol	Conditions	Values			Units
		Min.	Typ.	Max.	
VFM	T=25°C IF =300A	—	1.20	1.40	V
IRD	Tvj=150°C VRD=VRRM	—	—	9	mA
r _f	Tj=25°C		1.25		mΩ
V _{f0}			0.82		V

Performance Curves

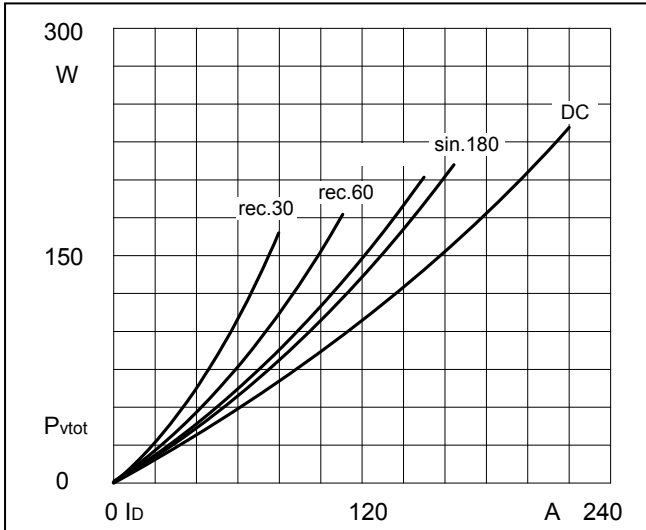

Fig1. Power dissipation

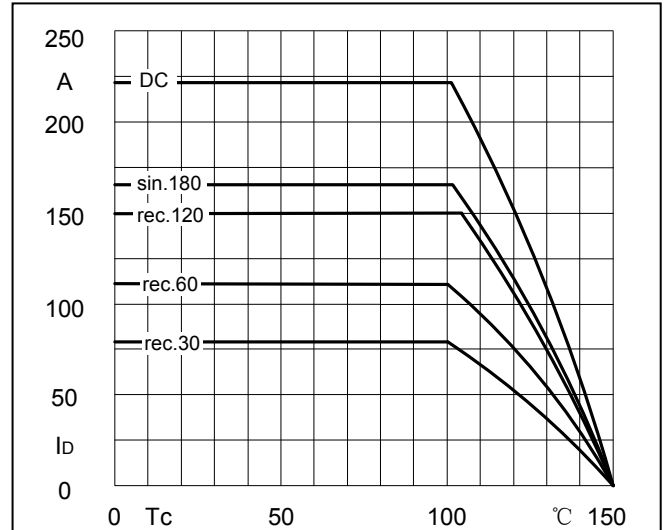

Fig2. Forward Current Derating Curve

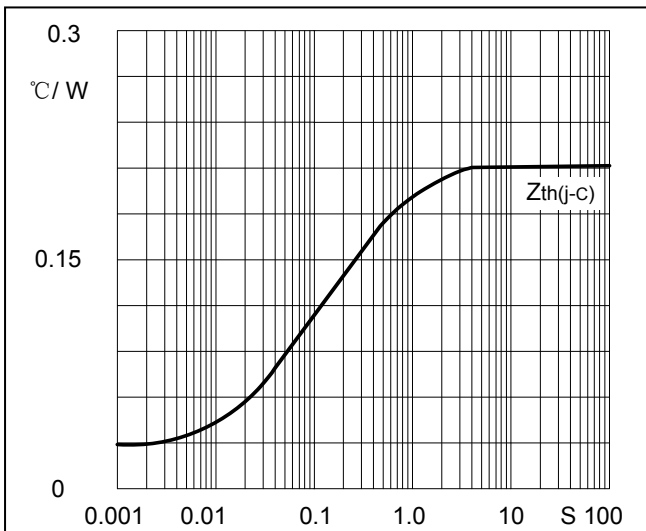

Fig3. Transient thermal impedance

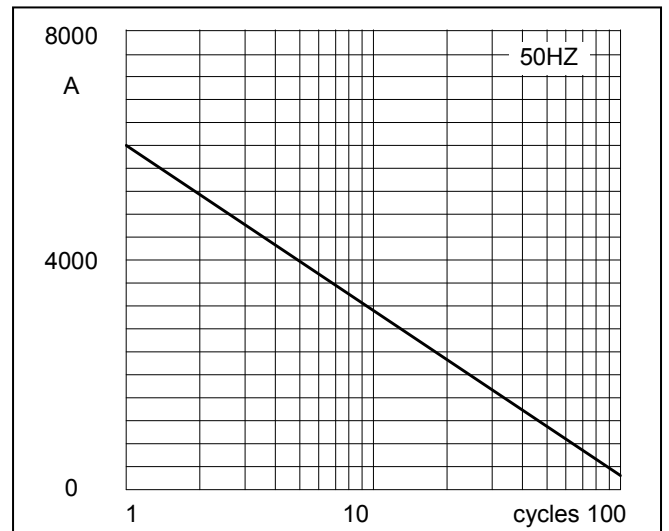

Fig4. Max Non-Repetitive Forward Surge Current

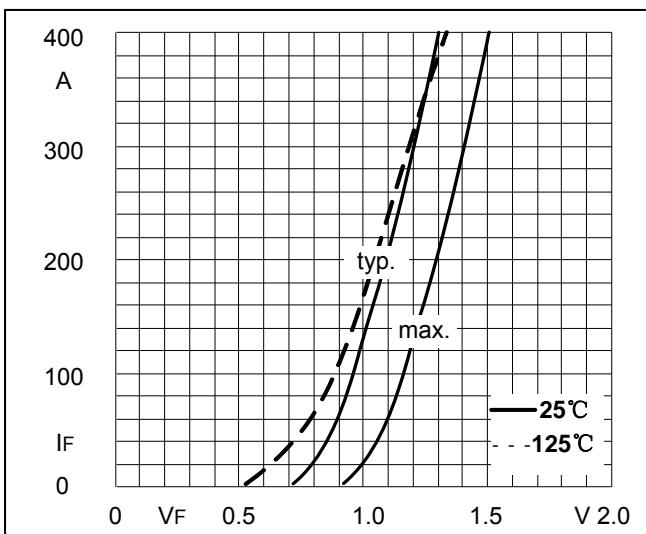

Fig5. Forward Characteristics



Micro Commercial Components®

Ordering Information :

Device	Packing
Part Number-BP	Bulk: 8PCS/BOX ;80PCS/CTN

IMPORTANT NOTICE

Micro Commercial Components Corp. reserves the right to make changes without further notice to any product herein to make corrections, modifications , enhancements , improvements , or other changes . **Micro Commercial Components Corp .** does not assume any liability arising out of the application or use of any product described herein; neither does it convey any license under its patent rights ,nor the rights of others . The user of products in such applications shall assume all risks of such use and will agree to hold **Micro Commercial Components Corp .** and all the companies whose products are represented on our website, harmless against all damages. **Micro Commercial Components Corp.** products are sold subject to the general terms and conditions of commercial sale, as published at <https://www.mccsemi.com/Home/TermsAndConditions>.

LIFE SUPPORT

MCC's products are not authorized for use as critical components in life support devices or systems without the express written approval of Micro Commercial Components Corporation.

CUSTOMER AWARENESS

Counterfeiting of semiconductor parts is a growing problem in the industry. Micro Commercial Components (MCC) is taking strong measures to protect ourselves and our customers from the proliferation of counterfeit parts. MCC strongly encourages customers to purchase MCC parts either directly from MCC or from Authorized MCC Distributors who are listed by country on our web page cited below. Products customers buy either from MCC directly or from Authorized MCC Distributors are genuine parts, have full traceability, meet MCC's quality standards for handling and storage. **MCC will not provide any warranty coverage or other assistance for parts bought from Unauthorized Sources.** MCC is committed to combat this global problem and encourage our customers to do their part in stopping this practice by buying direct or from authorized distributors.

www.mccsemi.com