

SPECIFICATIONS

(RoHS Compliant)



Model Number: SDD24B1E2X-E3
Part Number: 17001139A

Version: 00
Jun 12, 2018

Mechanical Drawing:

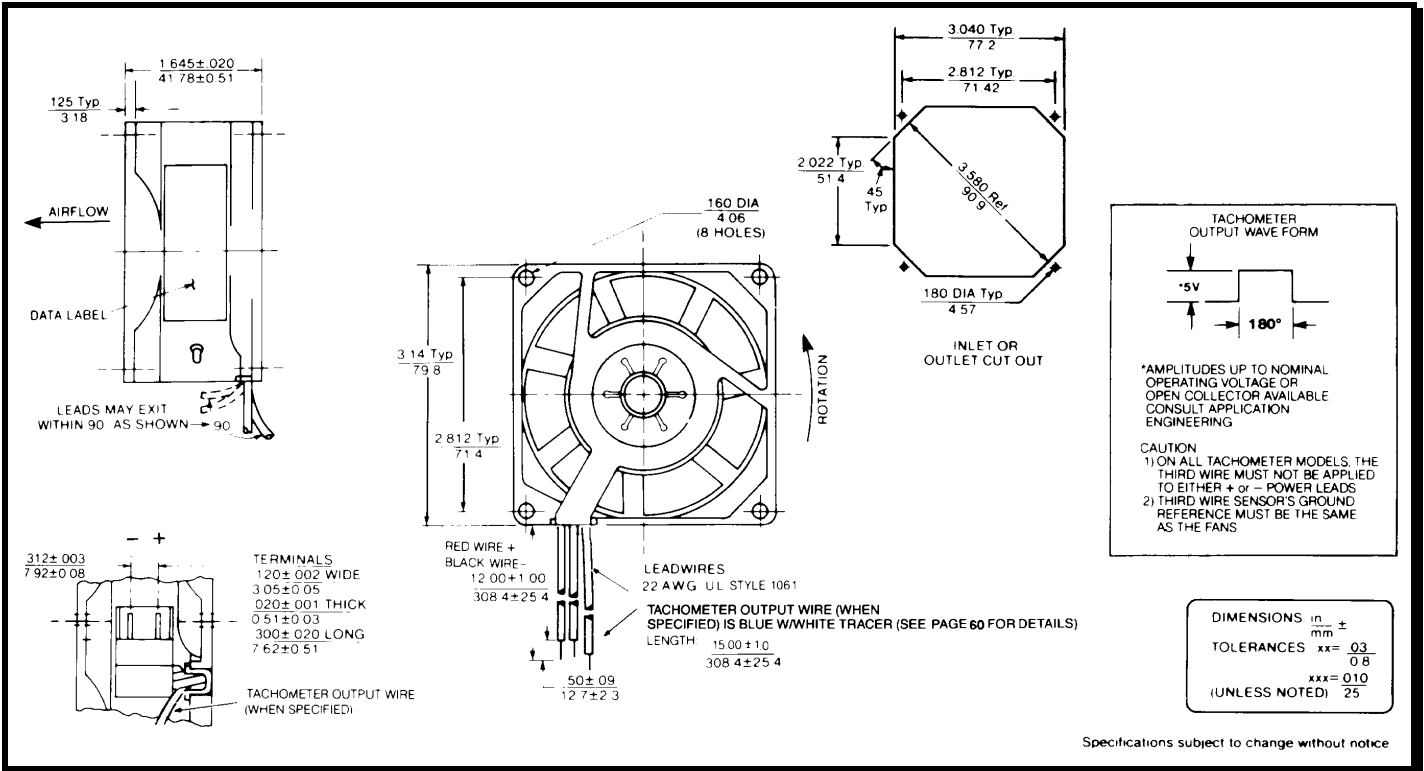

Motor:

Nominal Voltage	= 24 vdc
Operating Voltage Range	= 16 – 32vdc
Nominal Running Current	= 0.130 amps
Locked Rotor Current	= 0.6 amps
Running Power	= 3.0 watts
Average Speed	= 3500
Bearings	= Ball
Air Flow	= 35 CFM
Acoustic	= 47.6 dBA

Construction:

Venturi: Single Piece Die-Cast Zinc Alloy, Black
 Propeller: Plastic, Black, UL 94V-0

Life Expectancy:

This fan is designed for continuous duty life of 52,000 hours at 70°C.

Termination:

12" ± 1" (304.8 ± 25.4mm) 22AWG UL1061 Leadwires
 Red = Power(+)
 Black = Return(-)
 Blue/White = Tach output
 Yellow = PWM control

Additional Features:

Brushless DC Motor
 Automatic Restart Capability
 Electronic Locked Rotor Protection
 Polarity Protected
 Operating Temperature: -10°C to 70°C
 Storage Temperature: -40°C to 85°C
 Environmental Protection: Type 3(IP68)

TACHOMETER:

Output: Open Collector
 Ic: 20 mA max.
 Vcc: 32 Vdc max.
 Pulses per Revolution: 2
 Isolated: No

Speed Control:

PWM: 200 ~ 2 KHz, Open Collector
 <10% Duty: Off
 10%~95% Duty: Linear Ramp
 >95% Duty or Open Lead Wire: Full Speed

Agencies:

UL, CUL, CE

PQ Curve:

