

PN KEY ENGINEERING PN

E 4 7 2 X X X X X X X X X X

E - Packing without bag
W - Single Packing

Number of wires:
2 - 2 Wires + Earth

Cable type:
See Table

Head Colour:
G - Grey
N - Black
A - CSA-UL Black
B - CSA-UL Grey

Cable Length in[cm]
050 = 50cm
300 = 300cm
10K = 1000cm

Wiring Configuration:
See sheet 3

Voltage and Led Colour

Red Led:	Green Led:	Yellow Led:
1 = 12V	A = 12V	G = 12V
2 = 24V	B = 24V	H = 24V
3 = 48V	C = 48V	K = 48V
4 = 115V	D = 115V	L = 115V
5 = 230V	E = 230V	M = 230V

Earth PIN location (see insert orientation table):
2 = Earth on H12
6 = Earth on H6

Type of Gasket and Screw (see sheet 1):
1 = NBR Profile Gasket + Fixing Screw M3x25mm
2 = NBR Flat Gasket + Fixing Screw M3x25mm
3 = Silicone Profile Gasket + Fixing Screw M3x25mm
4 = Silicone Flat Gasket + Fixing Screw M3x25mm
P = NBR Integrated Gasket + Fixing Screw with Washer M3x27mm Assembled on Connector
R = NBR Integrated Gasket + Fixing Screw with Washer M3x27mm NOT Assembled on Connector
T = NBR Profile Gasket + Fixing Screw with Washer M3x27mm

CABLE TYPE	NO. OF WIRES	CROSS SECTION	CABLE O.D.	CABLE JACKET	UL	CSA	STATIC: TEMP. / BENDING RADIUS	DYNAMIC: TEMP. / BENDING RADIUS	SHIELD
A2	3	AWG 20	5.6mm±0.2	PVC BLACK	UL 2661	CSA C22.2	-30°C to +105°C, 10xO.D.	-5°C to +105°C, 15xO.D.	-
A3	3	AWG 18	6.5mm±0.25	PVC BLACK	UL 2661	CSA C22.2	-30°C to +105°C, 10xO.D.	-5°C to +105°C, 15xO.D.	-
B2	3	AWG 20	5.6mm±0.2	PUR BLACK	UL 20668	CSA C22.2	-40°C to +90°C, 5xO.D.	-25°C to +90°C, 10xO.D.	-
B3	3	AWG 18	6.5mm±0.2	PUR BLACK	UL 20668	CSA C22.2	-40°C to +90°C, 5xO.D.	-25°C to +90°C, 10xO.D.	-
F4	3	1mm²	7.1mm+0.2	PVC GREY	-	-	-15°C to +70°C, 10xO.D.	-5°C to +60°C, 15xO.D.	-
I0	3	1mm²	7.6mm±0.2	PVC GREY	-	-	-25°C to +70°C, 10xO.D.	-5°C to +70°C, 15xO.D.	YES
I2	3	0.5mm²	5.5mm+0.3	PVC GREY	-	-	-25°C to +70°C, 10xO.D.	-5°C to +70°C, 15xO.D.	-
I3	3	0.75mm²	6.0mm±0.2	PVC GREY	-	-	-25°C to +70°C, 10xO.D.	-5°C to +70°C, 15xO.D.	-
I4	3	1mm²	7.1mm+0.2	PVC GREY	-	-	-25°C to +70°C, 10xO.D.	-5°C to +70°C, 15xO.D.	-
N2	3	0.5mm²	5.6mm±0.7	PVC BLACK	-	-	-20°C to +70°C, 3xO.D.	-15°C to +70°C, 5xO.D.	-
N3	3	0.75mm²	6.8mm±0.8	PVC BLACK	-	-	-20°C to +70°C, 3xO.D.	-15°C to +70°C, 5xO.D.	-
N4	3	1mm²	7.15mm±0.85	PVC BLACK	-	-	-20°C to +70°C, 3xO.D.	-15°C to +70°C, 5xO.D.	-
P1	3	0.34mm²	5.3mm±0.2	PUR BLACK	-	-	-25°C to +80°C, 10xO.D.	-5°C to +80°C, 15xO.D.	-
P2	3	0.5mm²	5.5mm+0.3	PUR BLACK	-	-	-40°C to +90°C, 7.5xO.D.	-15°C to +90°C, 12.5xO.D.	-
P3	3	0.75mm²	6.5mm±0.2	PUR BLACK	-	-	-40°C to +90°C, 7.5xO.D.	-15°C to +90°C, 12.5xO.D.	-

Notes:

- Please see excel sheet 1210503400_PDP for currently configured part numbers.
- Drawing is a replacement for: SD-121050-005

SYMBOLS	THIS DRAWING CONTAINS INFORMATION THAT IS PROPRIETARY TO MOLEX ELECTRONIC TECHNOLOGIES, LLC AND SHOULD NOT BE USED WITHOUT WRITTEN PERMISSION		CURRENT REV DESC:		molex			
	mm	1:1	EC NO: 603741					STANDARD E472 DIN FORM B EN 175301-803
	GENERAL TOLERANCES (UNLESS SPECIFIED)		DRWN: APAWLAK01 2018/07/18		PRODUCT CUSTOMER DRAWING			
	ANGULAR TOL ± °		CHK'D: RSILLER 2018/08/31		DOCUMENT NUMBER			
4 PLACES ±		APPR: RSILLER 2018/08/31		1210503400		DOC TYPE	DOC PART	REVISION
3 PLACES ±		INITIAL REVISION:		PSD		000	A	
2 PLACES ± 0.05		DRWN: APAWLAK01 2018/07/18		MATERIAL NUMBER		CUSTOMER		SHEET NUMBER
1 PLACE ± 0.1		APPR: RSILLER 2018/08/31		SEE 1210503400_PDP		GENERAL MARKET		2 OF 3
0 PLACES ±		THIRD ANGLE PROJECTION		DRAWING		SERIES		
DRAFT WHERE APPLICABLE MUST REMAIN WITHIN DIMENSIONS		A3-SIZE		121050				

WIRING DIAGRAMS

ELECTRICAL DIAGRAM 00

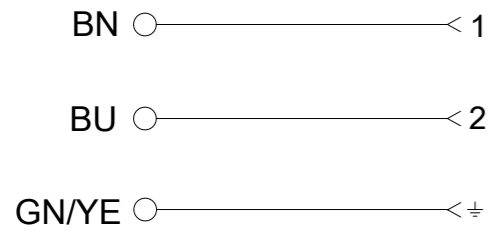

ELECTRICAL DIAGRAM A1

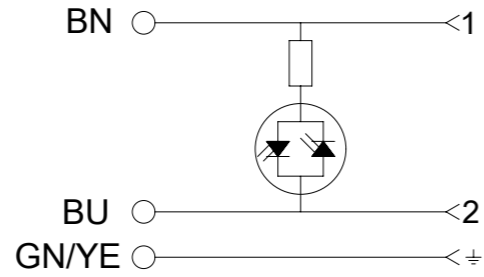

ELECTRICAL DIAGRAM C3

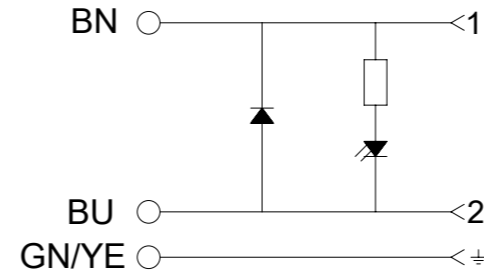

ELECTRICAL DIAGRAM C4

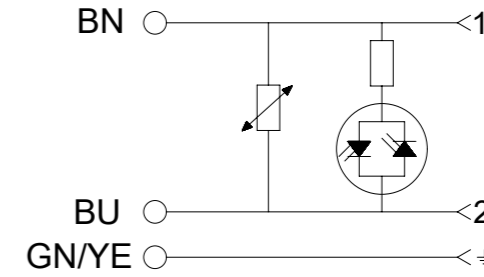

ELECTRICAL DIAGRAM E0

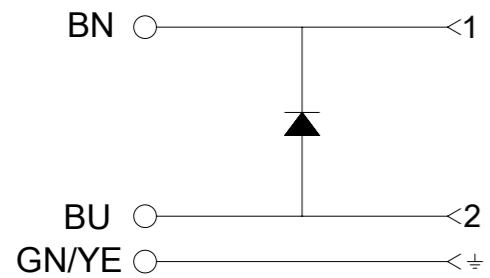

ELECTRICAL DIAGRAM S0

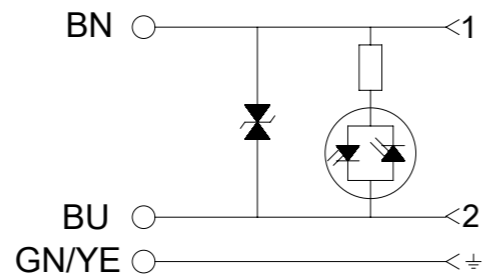

ELECTRICAL DIAGRAM S1

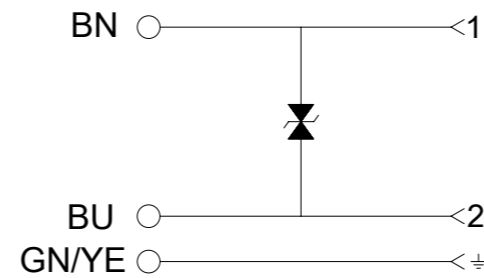

ELECTRICAL DIAGRAM NS

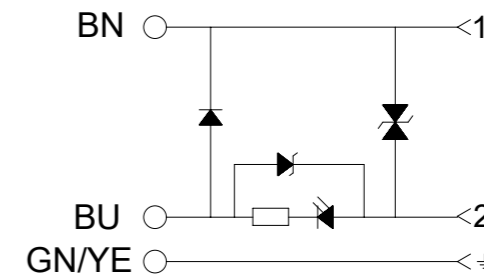

Technical Spec:
 Supply Voltage: See PN KEY
 Max. current: 5A; A1-C4-S0
 1,5A; R2
 Contact Resistance: ≤15milliohms max.
 Operating Temperature:
 with NBR Gasket: -40°C +90°C
 with Silicone: -40°C +125°C

SYMBOLS		THIS DRAWING CONTAINS INFORMATION THAT IS PROPRIETARY TO MOLEX ELECTRONIC TECHNOLOGIES, LLC AND SHOULD NOT BE USED WITHOUT WRITTEN PERMISSION	
DIMENSION UNITS	SCALE	CURRENT REV DESC:	
▽ = 0	mm	1:1	
▽ = 0	GENERAL TOLERANCES (UNLESS SPECIFIED)		
▽ = 0	ANGULAR TOL	±	°
▽ = 0	4 PLACES	±	
▽ = 0	3 PLACES	±	
▽ = 0	2 PLACES	±	0.05
▽ = 0	1 PLACE	±	0.1
▽ = 0	0 PLACES	±	
■ = 0	DRAFT WHERE APPLICABLE MUST REMAIN WITHIN DIMENSIONS		
▽ = 0	THIRD ANGLE PROJECTION	DRAWING	SERIES
		A3-SIZE	121050
		EC NO: 603741	
		DRWN: APAWLAK01	2018/07/18
		CHK'D: RSILLER	2018/08/31
		APPR: RSILLER	2018/08/31
		INITIAL REVISION:	
		DRWN: APAWLAK01	2018/07/18
		APPR: RSILLER	2018/08/31
		DOCUMENT NUMBER	DOC TYPE DOC PART REVISION
		1210503400	PSD 000 A
		MATERIAL NUMBER	CUSTOMER
		SEE 1210503400_PDP	GENERAL MARKET
			SHEET NUMBER
			3 OF 3

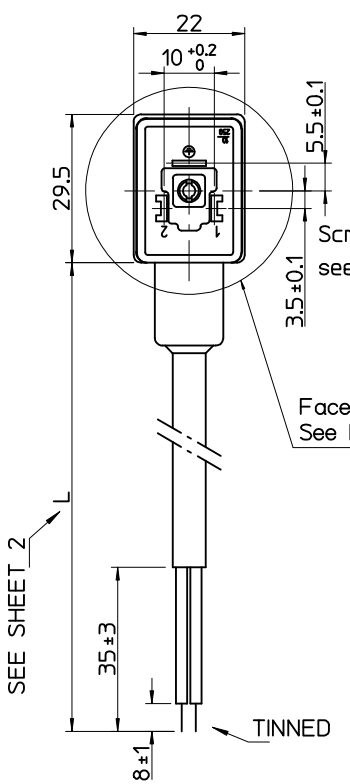

Screw and gasket,
see sheet 2, PN Key

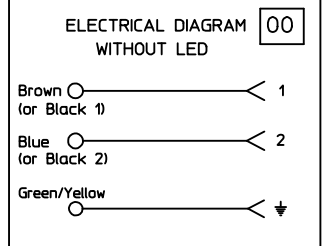
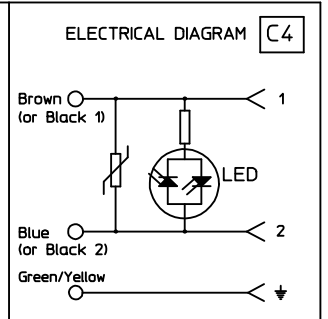
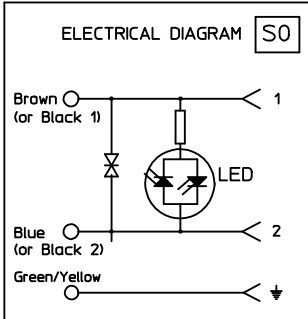
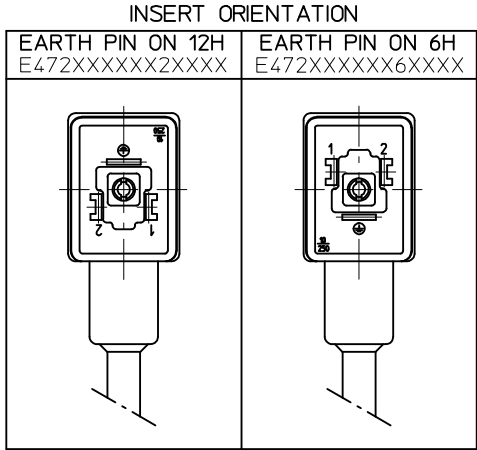
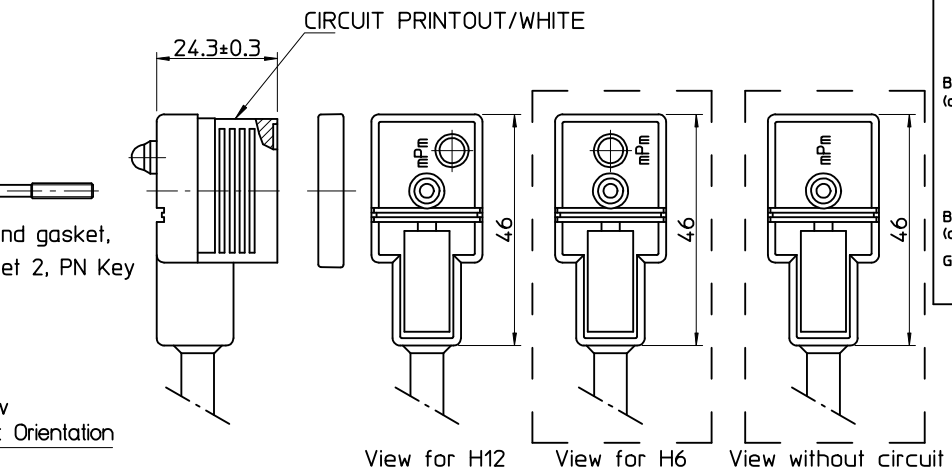

Table of length tolerances [mm]

Over	Up to and including	Tolerance (+)
0	1000	±20
1000	3000	±30
3000	5000	±40
5000	10000	±50
10000	15000	±100
15000	20000	±150
20000		±L/100

DRAWING UPDATE EC NO: IPG2013-1497 DRW: JMARSZALEK 2013/03/27 CHK: MDYSZEWSKA 2013/03/27 APPR: MIWASIECZKO 2013/03/28	QUALITY SYMBOLS ▽=0 ▽=0	GENERAL TOLERANCES (UNLESS SPECIFIED)		DIMENSION STYLE MM ONLY		SCALE	DESIGN UNITS METRIC	FIRST ANGLE PROJECTION	
		4 PLACES ±--- ±--- 3 PLACES ±--- ±--- 2 PLACES ±--- ±--- 1 PLACE ±--- ±--- 0 PLACE ±--- ±--- ANGULAR ±---°	mm INCH	DRAWN BY JMARSZALEK	DATE 2012/11/19	TITLE E472XXXXXXXXXXXX FORM B EN 175301-803			
B	REV	DRAFT WHERE APPLICABLE MUST REMAIN WITHIN DIMENSIONS		MATERIAL NO. SEE SHEET 2&3		DOCUMENT NO. SD-121050-005		SHEET NO. 1 OF 4	
		THIS DRAWING CONTAINS INFORMATION THAT IS PROPRIETARY TO MOLEX INCORPORATED AND SHOULD NOT BE USED WITHOUT WRITTEN PERMISSION		SIZE A3		molex			

10 | 9 | 8 | 7 | 6 | 5 | 4 | 3 | 2 | 1

F

F

E

E

D

D

C

C



B

B

A

A

9 | 8 | 7 | 6 | 5 | 4 | 3 | 2 | 1

DRAWING UPDATE EC NO: IPG2013-1497 DRWN: JMARSZALEK 2013/03/27 CHKD: MDYSZEWSKA 2013/03/27 APPR: MIWASIECZKO 2013/03/28	DESCRIPTION REV	QUALITY SYMBOLS  = 0  = 0	GENERAL TOLERANCES (UNLESS SPECIFIED)		DIMENSION STYLE MM ONLY		SCALE 1:1	DESIGN UNITS METRIC	 FIRST ANGLE PROJECTION	
		4 PLACES ± --- ± --- 3 PLACES ± --- ± --- 2 PLACES ± --- ± --- 1 PLACE ± --- ± --- 0 PLACE ± --- ± --- ANGULAR ± --- °	mm INCH	DRAWN BY DATE JMARSZALEK 2012/11/19 CHECKED BY DATE MSZWAJKOWSKI 2012/11/20 APPROVED BY DATE MIWASIECZKO 2013/02/12	TITLE E472XXXXXXXXXXXX FORM B EN 175301-803		MATERIAL NO. SEE SHEET 2&4		DOCUMENT NO. SD-121050-005	SHEET NO. 2 OF 4
DRAFT WHERE APPLICABLE MUST REMAIN WITHIN DIMENSIONS			THIS DRAWING CONTAINS INFORMATION THAT IS PROPRIETARY TO MOLEX INCORPORATED AND SHOULD NOT BE USED WITHOUT WRITTEN PERMISSION							



10 | 9 | 8 | 7 | 6 | 5 | 4 | 3 | 2 | 1

F

F

E

E

D

D

C



C

B

B

A

A

DRAWING UPDATE EC NO: IPG2013-1497 DRWN: JMARSZALEK 2013/03/27 CHKD: MDYSZEWSKA 2013/03/27 APPR: MIWASIECZKO 2013/03/28	DESCRIPTION REV	QUALITY SYMBOLS  = 0  = 0	GENERAL TOLERANCES (UNLESS SPECIFIED)		DIMENSION STYLE MM ONLY		SCALE 1:1	DESIGN UNITS METRIC	 FIRST ANGLE PROJECTION	
		4 PLACES ± --- ± --- 3 PLACES ± --- ± --- 2 PLACES ± --- ± --- 1 PLACE ± --- ± --- 0 PLACE ± --- ± --- ANGULAR ± --- °	mm INCH	DRAWN BY DATE JMARSZALEK 2012/11/19 CHECKED BY DATE MSZWAJKOWSKI 2012/11/20 APPROVED BY DATE MIWASIECZKO 2013/02/12	TITLE E472XXXXXXXXXXXX FORM B EN 175301-803 molex		MATERIAL NO. SEE SHEET 2&4	DOCUMENT NO. SD-121050-005	SHEET NO. 3 OF 4	
DRAFT WHERE APPLICABLE MUST REMAIN WITHIN DIMENSIONS			THIS DRAWING CONTAINS INFORMATION THAT IS PROPRIETARY TO MOLEX INCORPORATED AND SHOULD NOT BE USED WITHOUT WRITTEN PERMISSION							

9 | 8 | 7 | 6 | 5 | 4 | 3 | 2 | 1

10 9 8 7 6 5 4 3 2 1

F

F

E

E

D

D

C

C



B

B

A

A

9 8 7 6 5 4 3 2 1

DRAWING UPDATE EC NO: IPG2013-1497 DRWN: JMARSZALEK 2013/03/27 CHKD: MDYSZEWSKA 2013/03/27 APPR: MIWASIECZKO 2013/03/28	DESCRIPTION REV	QUALITY SYMBOLS  = 0  = 0	GENERAL TOLERANCES (UNLESS SPECIFIED)		DIMENSION STYLE MM ONLY		SCALE 1:1	DESIGN UNITS METRIC	 FIRST ANGLE PROJECTION	
		4 PLACES ± --- ± --- 3 PLACES ± --- ± --- 2 PLACES ± --- ± --- 1 PLACE ± --- ± --- 0 PLACE ± --- ± --- ANGULAR ± --- °	mm INCH	DRAWN BY DATE JMARSZALEK 2012/11/19 CHECKED BY DATE MSZWAJKOWSKI 2012/11/20 APPROVED BY DATE MIWASIECZKO 2013/02/12	TITLE E472XXXXXXXXXXXX FORM B EN 175301-803 molex		MATERIAL NO. SEE SHEET 2&4	DOCUMENT NO. SD-121050-005	SHEET NO. 4 OF 4	
DRAFT WHERE APPLICABLE MUST REMAIN WITHIN DIMENSIONS			THIS DRAWING CONTAINS INFORMATION THAT IS PROPRIETARY TO MOLEX INCORPORATED AND SHOULD NOT BE USED WITHOUT WRITTEN PERMISSION							