

30 Watt - LD30W Series

CONSTANT VOLTAGE OR CONSTANT CURRENT LED DRIVER WITH DIMMING



DIMMING
LD30W Series
30W

Model: LD30W Series

- Drive Mode: Constant Current or Constant Voltage
- Technology: PFC Off-Line Switch Mode
- Output Power: 30W Max.
- Input Voltage: 90 to 305VAC, 47-63Hz
- Number of Outputs: One
- Output Voltages: 4VDC - 85VDC
- Output Currents: 350mA - 2500mA
- Optional 0-10V or PWM Positive Dimming 10% to 100% (Iout ≤ 350mA Models Dimming is 12% to 100%)

Environmental

1. Operating temperature: Tc 90C Maximum. Reference -30 to +60°C ambient
2. Storage temperature range: -40 to +85°C
3. Humidity (non-condensing): 5% - 95%RH
4. Cooling: Convection
5. Vibration Frequency: 5-55Hz/2g, 30 minutes
6. Impact resistance: 1g/s
7. MTBF@ 25°C: 474,000 hours @ Full Load per MIL-217F Notice 2.

Safety and Compliance

1. UL8750, EN61347, CSA 22.2 safety compliant
2. FCC, 47CFR Part 15 Class B & EN55015 compliant.
3. Water resistant and Dust Proof Design: IP66, NEMA4, for Dry, Damp, Wet Locations.
4. Compact, Lightweight Design.
5. Safety Isolation between Primary and Secondary
6. Meets EN61000-3-2 & EN61000-3-3 Class C
7. Protection: output over-voltage, output over-current, output short circuit, auto-recovery.
8. EN61000-4-5: 2kV L-N, 8/20 µsec surge protection.

Electrical Specifications at 25°C

- Input voltage range: 90 to 305VAC
- Frequency: 47- 63HZ
- Power Factor: ≥ 0.90 at ≥ 60% Load, 120Vac/230Vac, ≥ 88% Load 277Vac
- THD%: ≤ 20% at ≥ 60% Load, 120Vac/230Vac, ≥ 80% Load 277Vac
- Inrush current: <30A at 25C, 277Vac, cold start, Max. Load
- Input current: 0.30A at 120Vac, 60Hz, Maximum Load
- Efficiency: 85% typical at 230Vac Full Load
- Constant Current regulation: +/-3% Over Input Line Variation
- Load regulation accuracy: +/-4%
- Leakage current: 400uA typical; Hold up time: half cycle



IP66



Constant Current Versions

Part Number ⁽²⁾	US Class 2	CN Class 2	Output Voltage Range	Output Constant Current	Current Accuracy	Output Power Maximum	Typical Efficiency ⁽¹⁾
LD30W-85-C0350	NO	NO	28 - 85 VDC	350 mA	+ 3%	30W	86%
LD30W-75-C0400	NO	NO	25 - 75 VDC	400 mA	+ 3%	30W	86%
LD30W-66-C0450	NO	NO	22 - 66 VDC	450 mA	+ 3%	30W	85%
LD30W-54-C0560	YES	YES	18 - 54 VDC	560 mA	+ 3%	30W	85%
LD30W-42-C0700	YES	YES	14 - 42 VDC	700 mA	+ 3%	30W	85%
LD30W-36-C0830	YES	YES	12 - 36 VDC	830 mA	+ 3%	30W	84%
LD30W-24-C1250 ⁽⁵⁾	YES	YES	8 - 24 VDC	1250 mA	+ 3%	30W	84%
LD30W-18-C1660	YES	YES	6 - 18 VDC	1660 mA	+ 3%	30W	83%
LD30W-12-C2500 ⁽⁵⁾	YES	YES	4 - 12 VDC	2500 mA	+ 3%	30W	83%

Notes

1. Typical efficiency measured at 230VAC input, full load
2. For dimmable versions add appropriate designator to the end of the part number: For Example: LD30W-18-C1660-RD is 0-10V or resistance dimmable version, LD30W-18-C1660-PD is PWM dimmable version.
-RD 0-10V & Resistance dimmable version comes with an extra two wires +Purple/-Grey on the output side.
-PD PWM Dimmable version comes with an extra two wires +Purple/-Grey on the output side.
3. -RD 0-10V Dimming is compatible with most quality 0-10V wall dimmers and direct 0-10V analog signal. See page 3 for details.
4. -PD PWM version is PWM Dimmable via a positive 10% to 100% Duty Cycle, 500Hz to 1.5KHz, 0-10V Pulse. See page 4 for details.
5. SAM Recognized

30W**LD30W Series****DIMMING****LED Optimized Drivers**

30 Watt - LD30W Series

CONSTANT VOLTAGE OR CONSTANT CURRENT LED DRIVER WITH DIMMING

Constant Voltage Versions

Part Number	US Class 2	CN Class 2	Output Voltage	Output Current Range	Voltage Accuracy	Output Power Maximum	Typical Efficiency ⁽¹⁾
LD30W-85	NO	NO	85 VDC	88 - 350 mA	± 5%	30W	86%
LD30W-75	NO	NO	75 VDC	100 - 400 mA	± 5%	30W	86%
LD30W-66	NO	NO	66 VDC	113 - 450 mA	± 5%	30W	85%
LD30W-54	YES	YES	54 VDC	140 - 560 mA	± 5%	30W	85%
LD30W-42	YES	YES	42 VDC	175 - 700 mA	± 5%	30W	85%
LD30W-36	YES	YES	36 VDC	208 - 830 mA	± 5%	30W	84%
LD30W-24 ⁽⁵⁾	YES	YES	24 VDC	313 - 1250 mA	± 5%	30W	84%
LD30W-18	YES	YES	18 VDC	415 - 1660 mA	± 5%	30W	83%
LD30W-12 ⁽⁵⁾	YES	YES	12 VDC	625 - 2500 mA	± 5%	30W	83%

Mechanical Dimensions: Inches [mm]

Material: Black PC ABS Plastic Case
Fully Encapsulated
Weight: 233 grams (8.2 oz) Typical

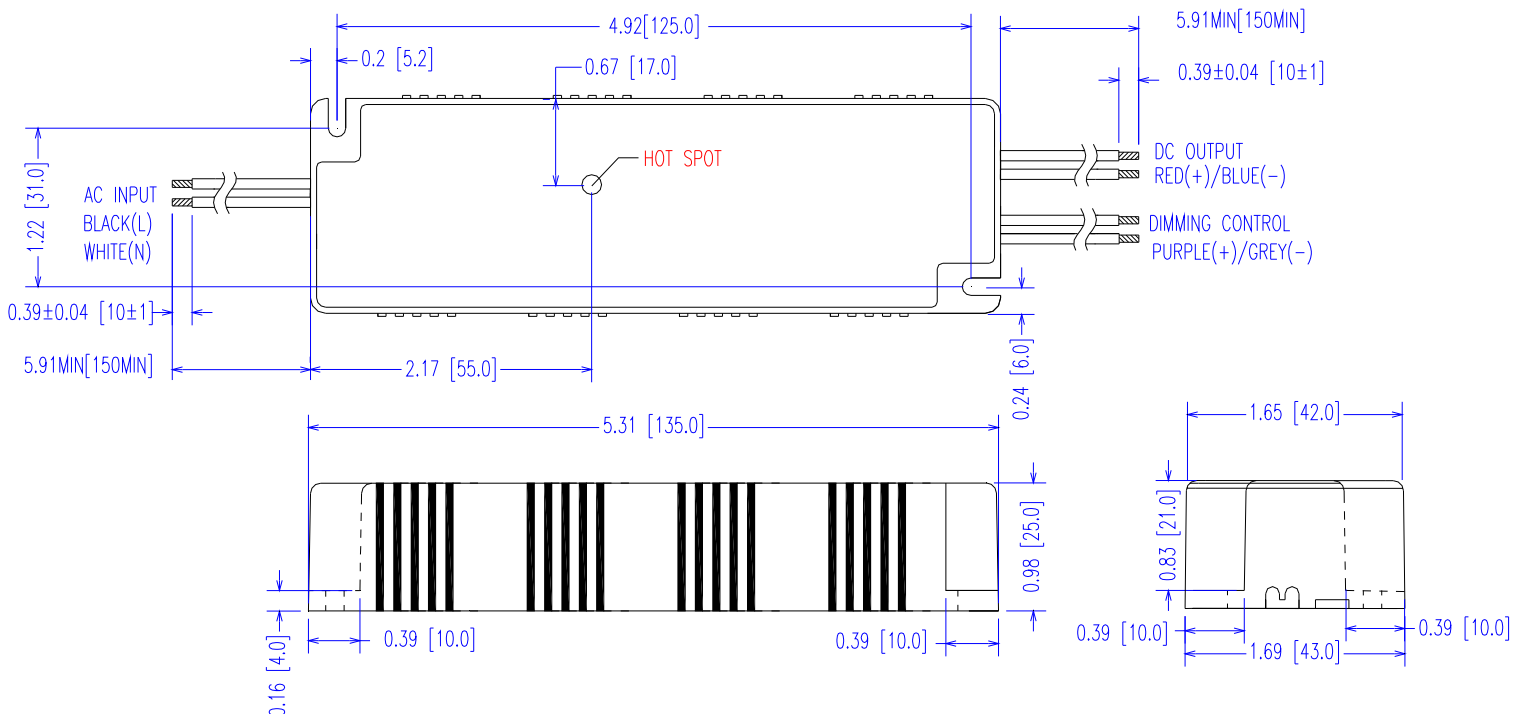
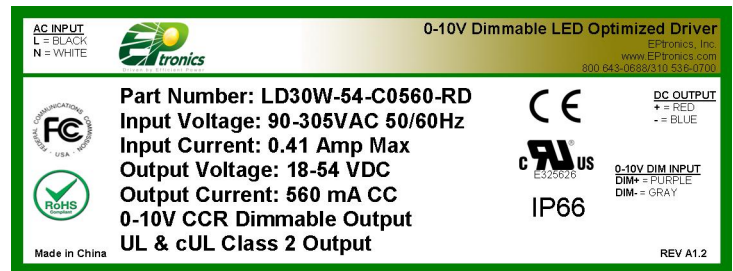
Labeling Example

30 Watt - LD30W Series

CONSTANT VOLTAGE OR CONSTANT CURRENT LED DRIVER WITH DIMMING

DIMMING
LD30W Series
30W

-RD 2-Wire 0-10V CCR Dimming Scheme

Parameters	Minimum	Typical	Maximum
Source Current out of 0-10V Purple Wire	0mA	—	2mA
Absolute Voltage Range on 0-10V (+) Purple Wire	-2.0V	—	+15V
Sink Current into 0-10V Purple Wire	0mA	—	1.2mA

Notes

- RD 0-10V dimmable version comes with an extra two wires +Purple/-Grey on the output side.
- RD version is compatible with most 0-10V Wall Slide dimmers and direct 0-10V analog signal.
Recommended wall slide dimmer is Leviton IP710 or equivalent
- RD 0-10V dimmable version is not intended to dim below about 5% @ 0V or 10% @ 1.0V. Models with $I_{out} \leq 350\text{mA}$ dim from 12% @ $V_{dim} = 1.0\text{V}$ to 100%
- RD 0-10V dimmable version output will be 100% with Purple/Grey open and minimum with Purple/Grey Shorted.

-RD 2-Wire Resistance Dimming Scheme

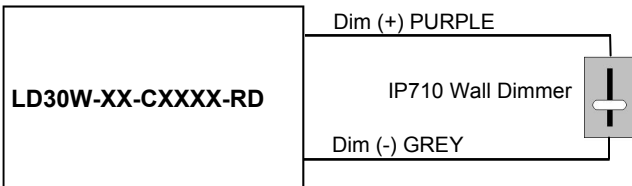

-RD 2-Wire 0-10V Analog Dimming Scheme

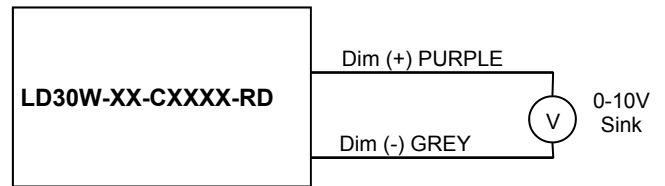

% Output Current vs. 0-10VDC Dimming Input

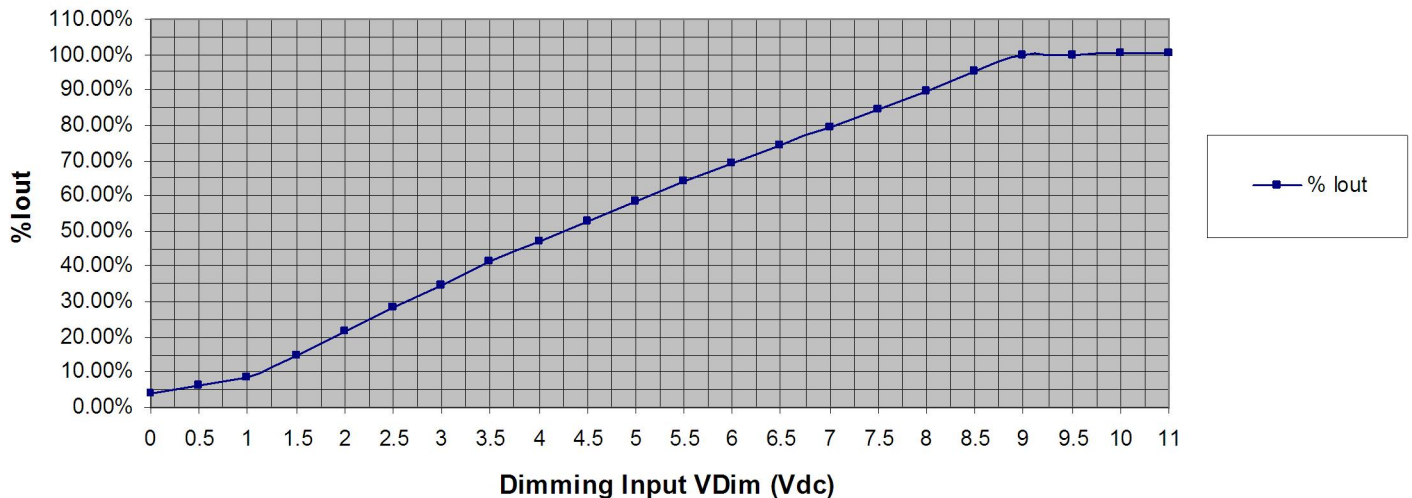

30 Watt - LD30W Series

CONSTANT VOLTAGE OR CONSTANT CURRENT LED DRIVER WITH DIMMING

-PD 2-Wire CCR PWM Positive Dimming Scheme

Parameters	Minimum	Typical	Maximum
Absolute Maximum Voltage Range on PWM Input (Purple Wire)	-2.0V	10V	+15V
Input LOW Level Voltage Range (Purple Wire)	-2.0V	0V	+5.5V
Input HIGH Level Voltage Range (Purple Wire)	+9.0V	10V	+15V
Current into PWM Input (Purple Wire)	0mA	—	1.2mA
Source Current out of PWM Input (Purple Wire)	0mA	—	2mA
PWM Input Signal Frequency	500Hz	—	1500Hz
PWM Input Signal Positive Duty Cycle	0%	10-90%	100%

Notes

1. -PD PWM Dimmable version comes with an extra 2 wires +Purple/-Grey on the output side.
2. -PD PWM Dimmable version is not intended to dim below about 5% @ 0% Duty Cycle or 10% @ 10% Duty Cycle
3. -PD PWM dimmable version output will be 100% with Purple/Grey open and minimum with Purple/Grey Shorted.

-PD 2-Wire PWM Positive Dimming Scheme

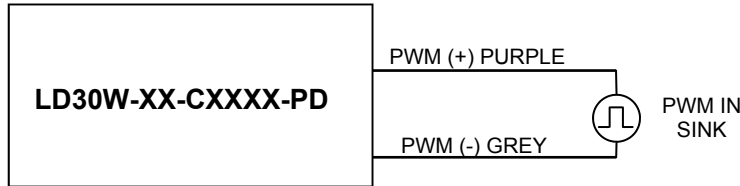

% Output Current vs. 1.0 kHz, Positive Duty Cycle Dimming Input

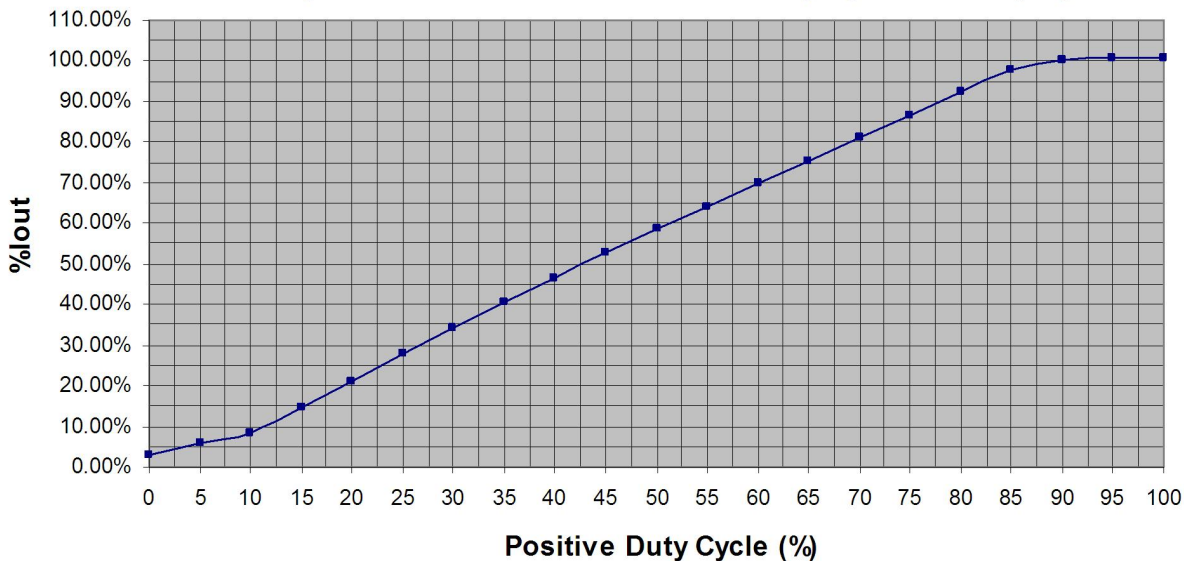

—■ % Iout

30 Watt - LD30W Series

CONSTANT VOLTAGE OR CONSTANT CURRENT LED DRIVER WITH DIMMING

DIMMING
LD30W Series
30W

Input Specifications

Parameter	Min.	Typ.	Max.	Notes/Conditions
Input Voltage	90 Vac	—	305 Vac	120, 230, 240, 277 Vac Nominal Values
Input Frequency	47 Hz	—	63 Hz	50/60Hz Nominal
Input AC Current	—	—	0.30 A	Measured at 120Vac/60Hz Input, Output Full load.
	—	—	0.14 A	Measured at 230Vac/60Hz Input, Output Full load.
Inrush Current (Peak)	—	—	30A	Measured at 277Vac/60Hz Input, Output Full Load, Ta 25°C, Cold Start 50% I _{peak} duration \approx 750 μ sec ($1/2 \cdot I_p^2 \cdot t$)
Inrush Current (I ² t)	—	—	0.34 A ² s	
Leakage Current	—	—	0.28mA	Measured at 120Vac/60Hz Input, Output Full load.
	—	—	0.75mA	Measured at 277Vac/60Hz Input, Output Full load.
THD	—	—	20%	\geq 60% Load @ 120Vac/230Vac, \geq 80% Load @ 277Vac
Power Factor (PF)	0.90	—	—	\geq 60% Load @ 120Vac/230Vac, \geq 88% Load @ 277Vac

Output Specifications

Parameter	Min.	Typ.	Max.	Notes/Conditions
DC Output Voltage	Per Table	—	Per Table	Per Tables on Page 1
DC Output Constant Current	-3%	Per Table	+3%	Per Tables on Page 1
Output Power	—	—	Per Table	Per Tables on Page 1
Ripple & Noise (V _{pk-pk})	—	—	20% V _o	20 MHz BW, Full load output in parallel with 0.1 μ F ceramic & 10 μ F Electrolytic.
Ripple (I _{pk-pk})	—	—	50% I _o	20 MHz BW, Full load output in parallel with 0.1 μ F ceramic & 10 μ F Electrolytic. 120 Hz component
Start-up Time	—	700 mS	1000 mS	Measured at 120Vac/60Hz Input, Output Full load.
Hold-up Time	—	30 mS	—	Typical @ 277Vac Input, Output Full load.

Environmental Specifications

Parameter	Min.	Typ.	Max.	Notes/Conditions
Case Temperature (T _c)	-30 °C	—	+90 °C	Measured at location specified on case.
Operating Temperature (T _a)	-30 °C	—	+60 °C	This is a reference range. T _c controls temperature range.
Storage Temperature (T _s)	-40 °C	—	+85 °C	Non operating temperature range.
Operating Humidity	—	—	95% RH	Relative Humidity, non-condensing.
Vibration	5 Hz	—	55 Hz	2G, 10 minutes/1 cycle, period 30 minutes, each along X, Y, Z axis.
MTBF	474,000 Hours	—	—	MIL-HDBK-217F Notice 2, T _a = 25C, Output Full Load.

Protection Specifications

Parameter	Min.	Typ.	Max.	Notes/Conditions
Output Short Circuit (SCP)	—	—	—	No Damage, Auto recovery after short is removed.
Output Over Current (OCP)	—	—	+8% I _o	Constant Current Limiting circuit.
Output Over Voltage (OVP)	—	—	120% V _o	No Damage, Auto recovery after fault is removed.

30 Watt - LD30W Series

CONSTANT VOLTAGE OR CONSTANT CURRENT LED DRIVER WITH DIMMING

Safety Compliance

Safety	Notes/Standards
UL/CUL	UL8750 & CAN/CSA-22.2 No. 250.13-12, UL1310 & CAN/CSA-22.2 No. 223-M91 for Class 2, UL1012/CSA-C22.2 No. 107.1 for Non Class 2
CE	EN61347-1, EN61347-2-13
Withstand Voltage	Input to Output: 3750 Vac
Isolation Resistance	Input to Output: >100 M Ω , 500VDC @ 25 °C, 70 % RH
Dimming Circuit	Dim+ Purple/Dim- Grey are considered part of the secondary circuit.

EMC Compliance

Standard	Notes/Conditions
FCC, 47CFR Part 15	Class B
EN 55015	Limits and methods of measurement of radio disturbance characteristics of electrical lighting and similar equipment.
EN 61000-3-2	Part 3-2: Limits for harmonic current emissions Class C, $\geq 80\%$ Rated Power
EN 61000-3-3	Part 3-3: Limitation of voltage changes, voltage fluctuations and flicker.
EN 61000-4-5	Part 4-5: Surge Immunity test, 2 kV L-N, 4 kV L-FG & N-FG
Energy Star	Energy Star transient protection: Ballast or driver shall comply with ANSI/IEEE C62.41.1-2002 and ANSI/IEEE C62.41.2-2002, Category A operation. The line transient shall consist of seven strikes of a 100 kHz ring wave, 2.5 kV level, for both common mode and differential mode.

Power Factor Curves (Typical)

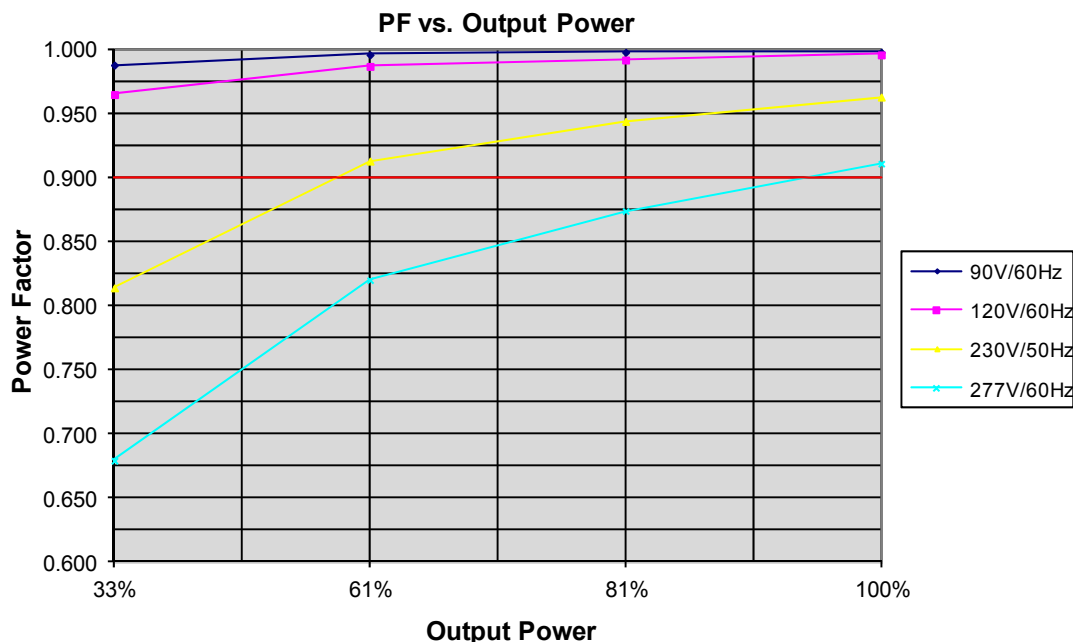

30 Watt - LD30W Series

CONSTANT VOLTAGE OR CONSTANT CURRENT LED DRIVER WITH DIMMING

DIMMING

30W
LD30W Series

THD Curves (Typical)

THD vs. Output Power

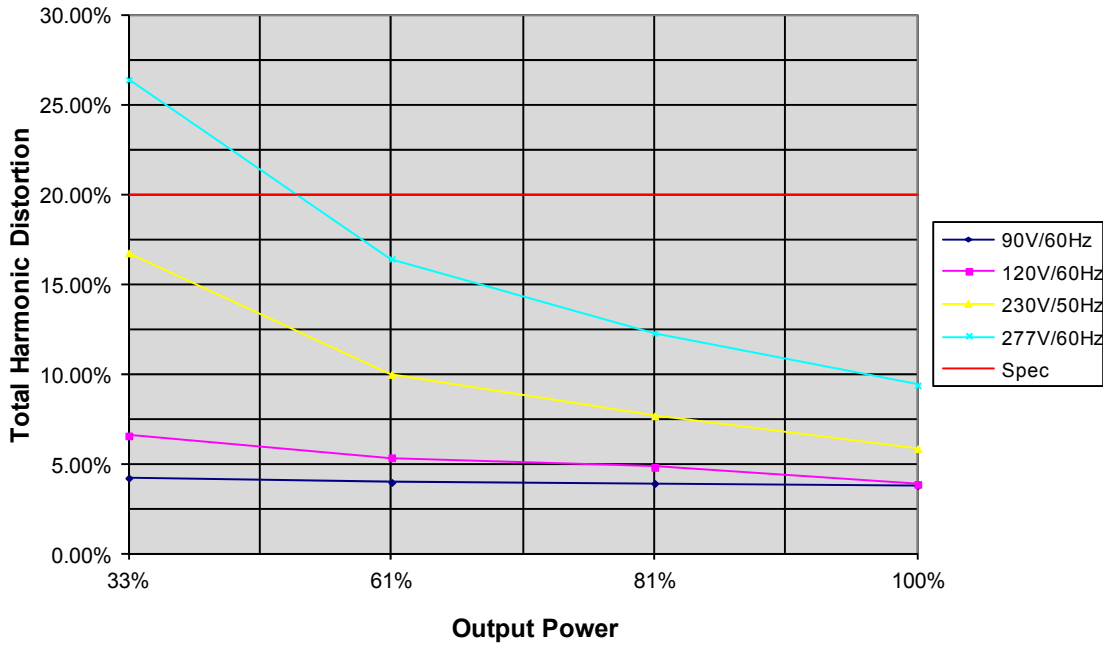

Efficiency Curve (Typical)

Efficiency vs. Output Power

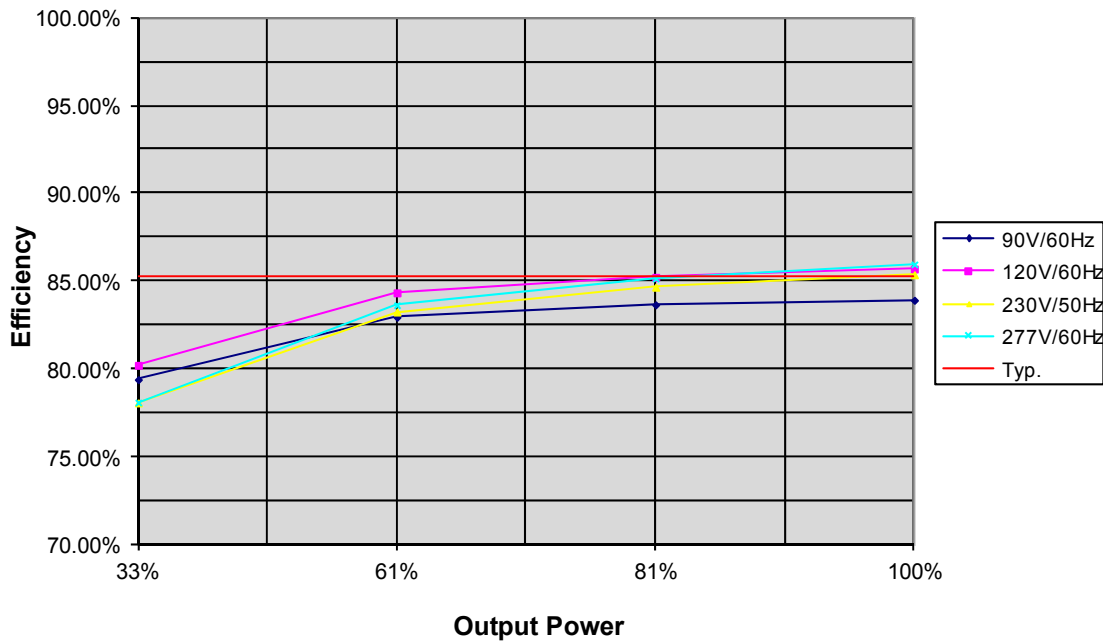

30W

LD30W Series

DIMMING



LED Optimized Drivers

30 Watt - LD30W Series

CONSTANT VOLTAGE OR CONSTANT CURRENT LED DRIVER WITH DIMMING

Life vs. Ambient Temperature

LD30W Estimated Life Full Load @ 120Vac

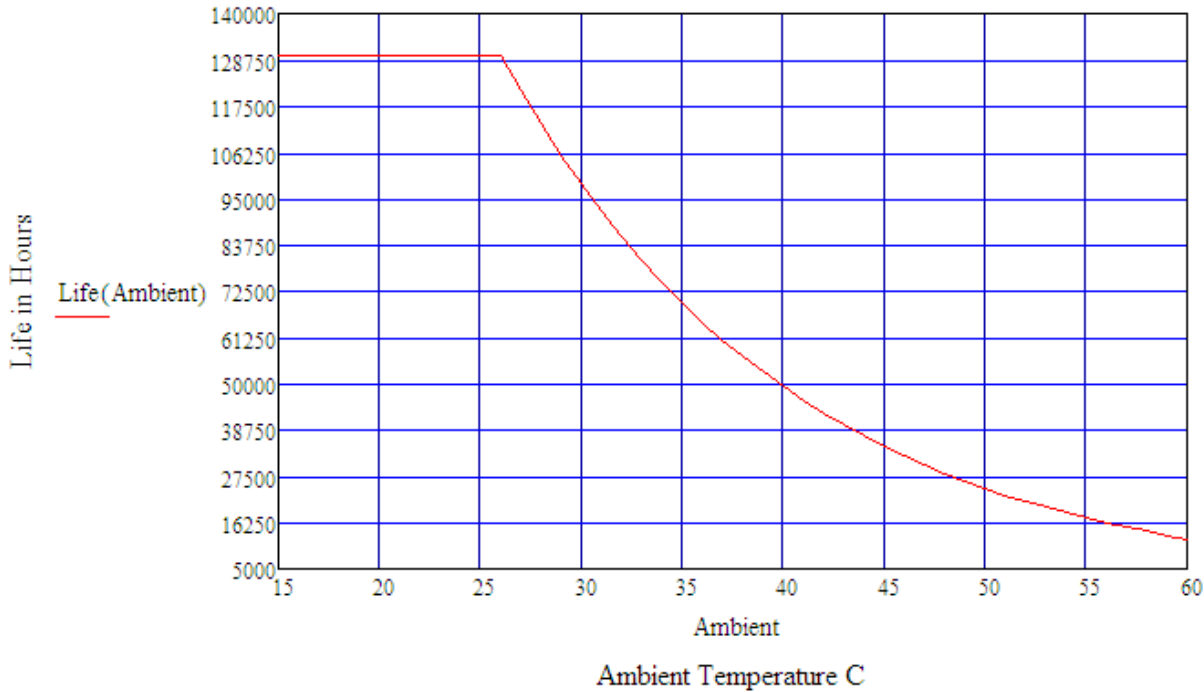

Life vs. Case (Tc) Temperature

LD30W Estimated Life Full Load @ 120Vac

