



American Opto Plus LED

L-513NBGC-32D

5mm Dia LED LAMP -WATER CLEAR
(GaN Bluegreen)

MAIN FEATURES
 5.0mm DIA LED LAMP
 POPULAR T-1 3/4 ,1" LEAD
 I.C. COMPATABLE
 LOW POWER CONSUMPTION

DESCRIPTION

- Super bright LED Lamp
- Round type
- T1-3/4 (5mm) diameter
- Lens color: Water Clear
- With Flange
- Solder leads without stand-off

FEATURES

- Emitted color: Super Green
- High Luminous intensity
- Technology: INGaN
- Peak wavelength $\lambda_p = 507\text{nm}$
- Viewing angle: 32°

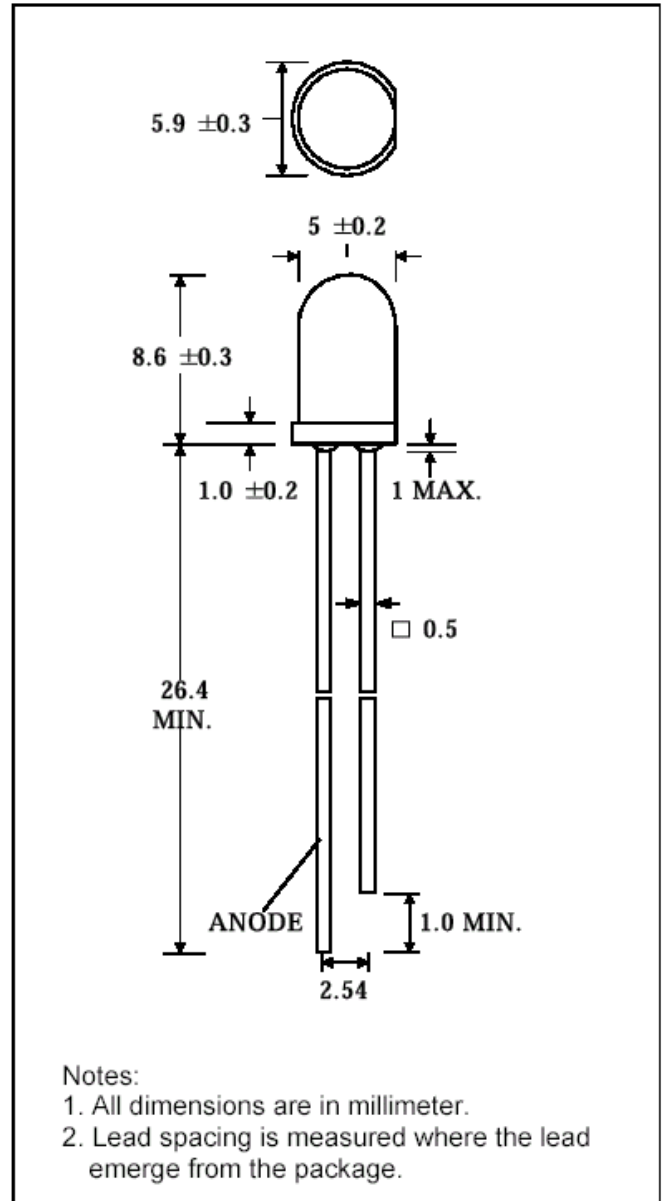

SELECTION GUIDE

Chip Material	Chip Emitted	Lens Color	Viewing Angle
INGaN	Super Green	Water Clear	32°



American Opto Plus LED
L-513NBGC-32D
5mm Dia LED LAMP -WATER CLEAR
(GaN Bluegreen)

MAIN FEATURES
5.0mm DIA LED LAMP
POPULAR T-1 3/4 ,1" LEAD
I.C. COMPATABLE
LOW POWER CONSUMPTION

ABSOLUTE MAXIMUM RATINGS

(Ta=25 °C)

PARAMETER	SYMBOL	MAX. RATING	Unit
Power Dissipation	P_D	120	mW
Peak Forward Current (1/10 Duty Cycle @1KHz)	I_{PF}	100	mA
Continuous Forward Current	I_{AF}	30	mA
Reverse Voltage	V_R	5.0	V
Operating Temperature Range	T_{OPR}	-20~+80	°C
Storage Temperature Range	T_{STG}	-30~+100	°C

Solder temperature 1.6 mm from body for 3 seconds at 260 °C

OPTICAL-ELECTRICAL CHARACTERISTICS

PARAMETER	SYMBOL	TEST CONDITION	MIN	TYP	MAX	UNIT
Luminous Intensity	I_V	$I_F = 20mA$	5000	7500		mcd
Forward Voltage	V_F	$I_F = 20mA$		3.5	4.0	V
Reverse Current	I_R	$V_R = 5V$			10	uA
Viewing Angle	2θ1/2	$I_F = 20mA$		32		deg.
Peak Wavelength	λ_P	$I_F = 20mA$		507		nm
Dominant Wavelength	λ_D	$I_F = 20mA$		505		nm
Spectrum Radiation Bandwidth	$\Delta \lambda$	$I_F = 20mA$		30		nm

*Tolerance of Viewing Angle: -10 / +5 deg.



American Opto Plus LED L-513NBGC-32D

5mm Dia LED LAMP -WATER CLEAR
(GaN Bluegreen)

MAIN FEATURES

- 5.0mm DIA LED LAMP
- POPULAR T-1 3/4 ,1" LEAD
- I.C. COMPATABLE
- LOW POWER CONSUMPTION

TYPICAL OPTICAL-ELECTRICAL CHARACTERISTIC CURVES

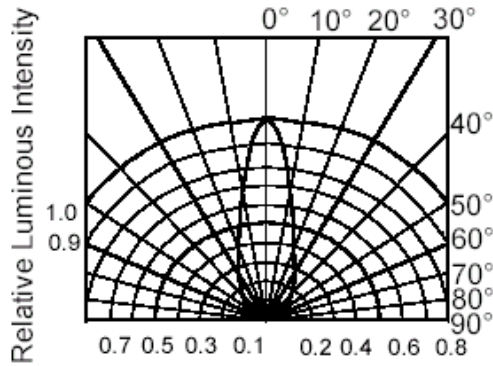

RADIATION DIAGRAM

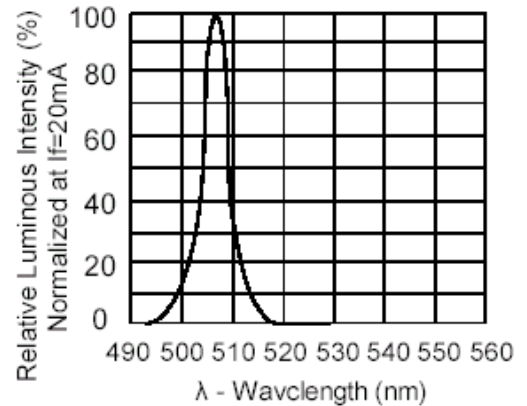

**RELATIVE LUMINOUS INTENSITY
Vs. WAVELENGTH**

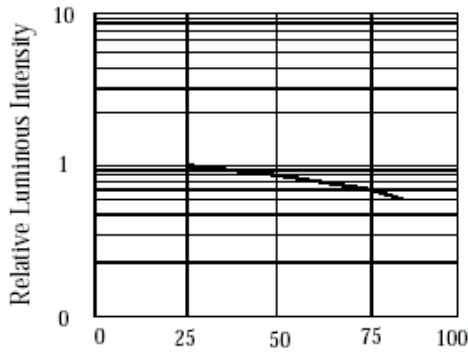

**LUMINOUS INTENSITY
Vs. AMBIENT TEMPERATURE**

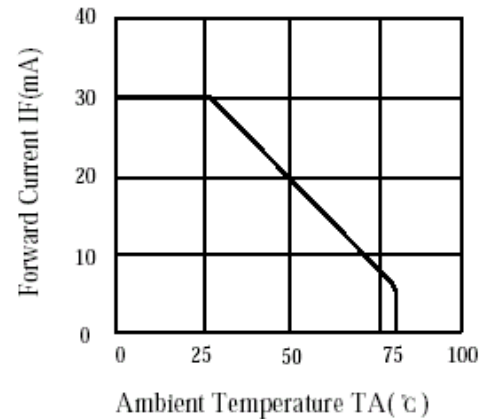

**FORWARD CURRENT
Vs. AMBIENT TEMPERATURE**

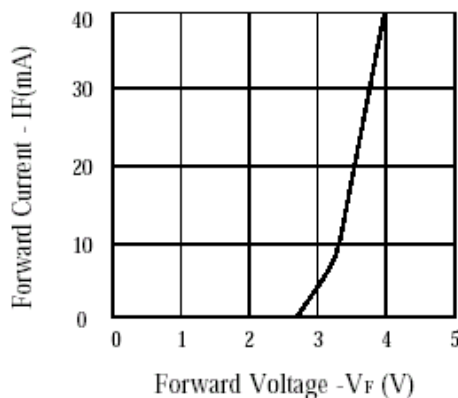

**FORWARD CURRENT
Vs. FORWARD VOLTAGE**

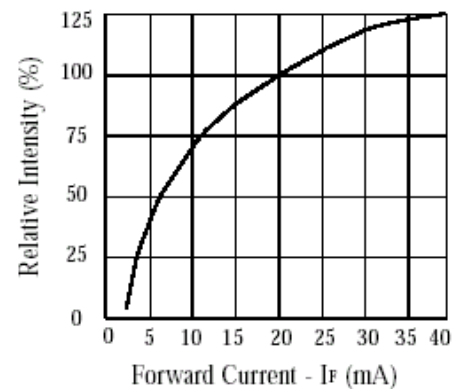

**LUMINOUS INTENSITY
Vs. FORWARD CURRENT**