

CGHV35120F

120 W, 2.9 - 3.8 GHz, 50 V, GaN HEMT
for S-Band Radar Systems

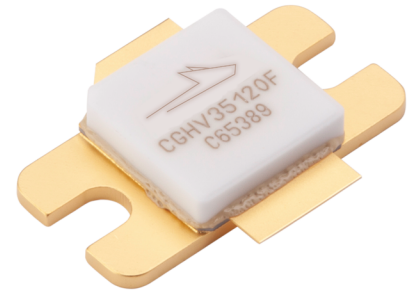

Description

WolfSpeed's CGHV35120F is a gallium nitride (GaN) high electron mobility transistor (HEMT) designed specifically with high efficiency, high gain and wide bandwidth capabilities, which makes the CGHV35120F ideal for 2.9 - 3.8 GHz S-Band radar amplifier applications. The transistor is supplied in a ceramic/metal flange package.

PN: 440162
Package Type: CGHV35120F

Typical Performance 3.1 - 3.5 GHz ($T_c = 85^\circ\text{C}$)

Parameter	3.1 GHz	3.2 GHz	3.3 GHz	3.4 GHz	3.5 GHz	Units
Output Power	142	135	132	136	134	W
Gain	13	12.8	12.8	12.9	12.8	dBc
Drain Efficiency	68	66	63	62	62	%

Note: Measured in the CGHV35120F-AMP1 application circuit, under 100 μs pulse width, 10% duty cycle, $P_{IN} = 38.5 \text{ dBm}$

Features

- Rated Power = 120 W @ $T_{CASE} = 85^\circ\text{C}$
- Operating Frequency = 2.9 - 3.8 GHz
- Transient 100 μsec - 300 μsec @ 20% Duty Cycle
- 13 dB Power Gain @ $T_{CASE} = 85^\circ\text{C}$
- 62% Typical Drain Efficiency @ $T_{CASE} = 85^\circ\text{C}$
- Input Matched
- <0.3 dB Pulsed Amplitude Droop



Large Signal Models Available for ADS and MWO





Absolute Maximum Ratings (not simultaneous)

Parameter	Symbol	Rating	Units	Conditions
Drain-Source Voltage	V_{DSS}	150	V	25°C
Gate-to-Source Voltage	V_{GS}	-10, +2		
Storage Temperature	T_{STG}	-65, +150	°C	
Operating Junction Temperature	T_J	225		
Maximum Forward Gate Current	I_{GMAX}	22.5	mA	25°C
Maximum Drain Current ¹	I_{DMAX}	9	A	
Soldering Temperature ²	T_S	245	°C	
Screw Torque	τ	40	in-oz	
Pulsed Thermal Resistance, Junction to Case ³	$R_{\theta JC}$	1.2	°C/W	300 μ sec, 20%, 85°C
Case Operating Temperature	T_C	-40, +130	°C	

Notes:

¹ Current limit for long term, reliable operation

² Refer to the Application Note on soldering at wolfspeed.com/rf/document-library

³ Measured for the CGHV35120F at $P_{DISS} = 80$ W

Electrical Characteristics

Characteristics	Symbol	Min.	Typ.	Max.	Units	Conditions
DC Characteristics¹ ($T_C = 25^\circ\text{C}$)						
Gate Threshold Voltage	$V_{GS(th)}$	-3.8	-3.0	-2.3	V_{DC}	$V_{DS} = 10$ V, $I_D = 21.6$ mA
Gate Quiescent Voltage	$V_{GS(Q)}$	—	-2.7	—		$V_{DS} = 48$ V, $I_D = 220$ mA
Saturated Drain Current ²	I_{DS}	16.2	20.1	—	A	$V_{DS} = 6.0$ V, $V_{GS} = 2.0$ V
Drain-Source Breakdown Voltage	V_{BR}	125	—	—	V_{DC}	$V_{GS} = -8$ V, $I_D = 21.6$ mA
RF Characteristics³ ($T_C = 25^\circ\text{C}$, $F_0 = 3.1 - 3.5$ GHz unless otherwise noted)						
Output Power at 3.1 GHz	P_{OUT}	135	142	—	W	$V_{DD} = 48$ V, $I_{DQ} = 220$ mA, $P_{IN} = 38.5$ dBm
Output Power at 3.5 GHz		120	134	—		
Output Return Loss	ORL	—	-8	-6	dB	
Input Return Loss	IRL	—	-8	-6		
Gain at 3.1 GHz	G_p	—	13	—		
Gain at 3.5 GHz		—	12.8	—		
Drain Efficiency at 3.1 GHz	D_E	64	68	—	%	
Drain Efficiency at 3.5 GHz		60	62	—		
Amplitude Droop	D	—	-0.3	—	dB	
Output Mismatch Stress	VSWR	—	—	5 : 1	Ψ	
Dynamic Characteristics						
Input Capacitance	C_{GS}	—	65	—	pF	$V_{DS} = 48$ V, $V_{GS} = -8$ V, $f = 1$ MHz
	C_{DS}	—	9.5	—		
	C_{GD}	—	0.7	—		

Notes:

¹ Measured on wafer prior to packaging

² Scaled from PCM data

³ Measured in CGHV35120-AMP. Pulse Width = 100 μ s, Duty Cycle = 10%



Typical Performance

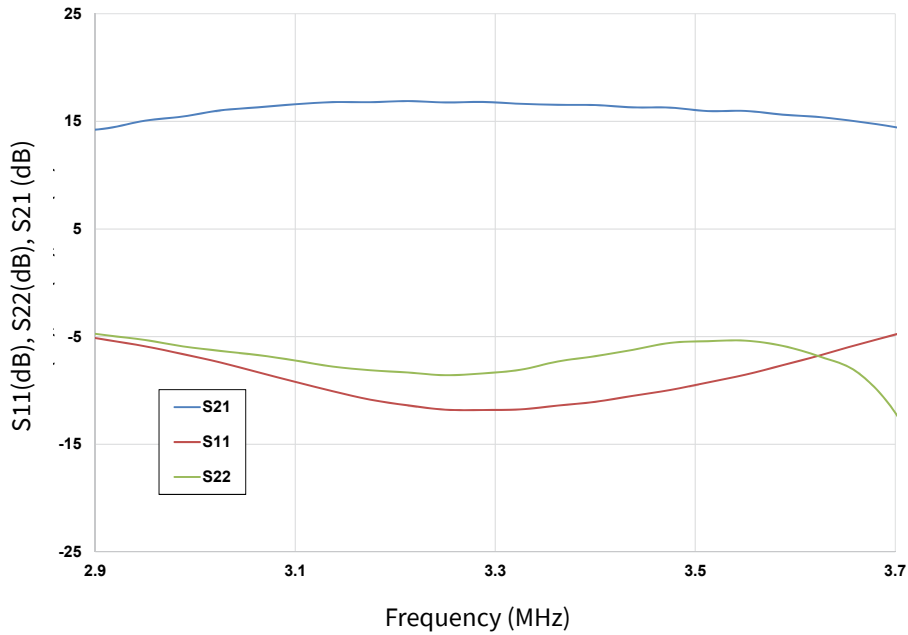

Figure 1. CGHV35120F Typical S Parameters Measured in CGHV35120F-AMP1
 $V_{DD} = 48\text{ V}$, $I_{DQ} = 220\text{ mA}$, $T_{CASE} = 25^{\circ}\text{C}$

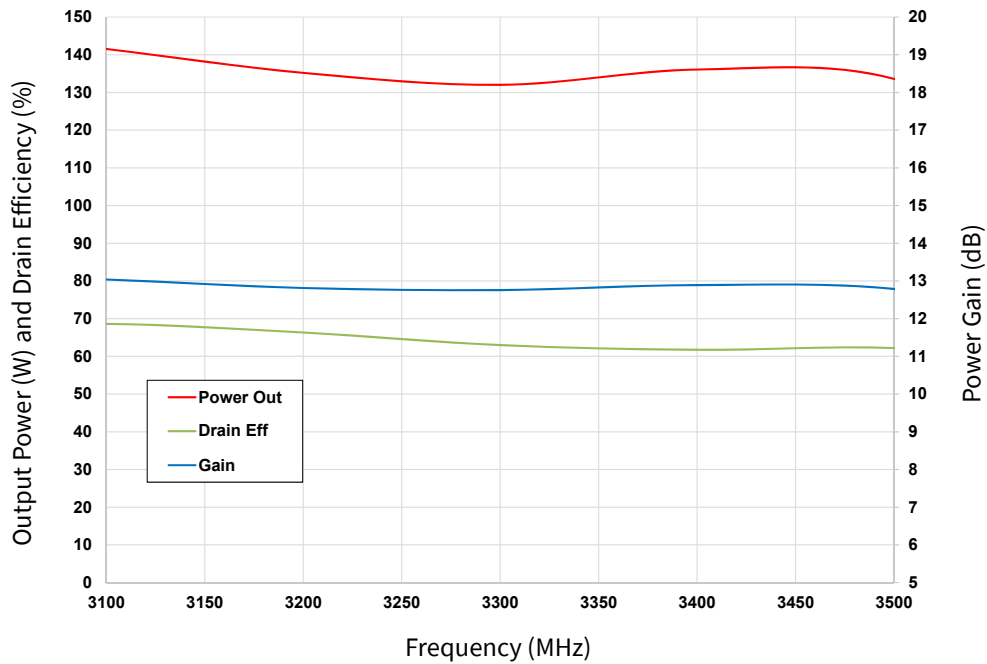

Figure 2. CGHV35120F Typical RF Results Measured in CGHV35120F-AMP1
 $V_{DD} = 48\text{ V}$, $I_{DQ} = 220\text{ mA}$, $T_{PLATE} = 85^{\circ}\text{C}$, Pulse Width = 100 μs , Duty Cycle = 10%



Typical Performance

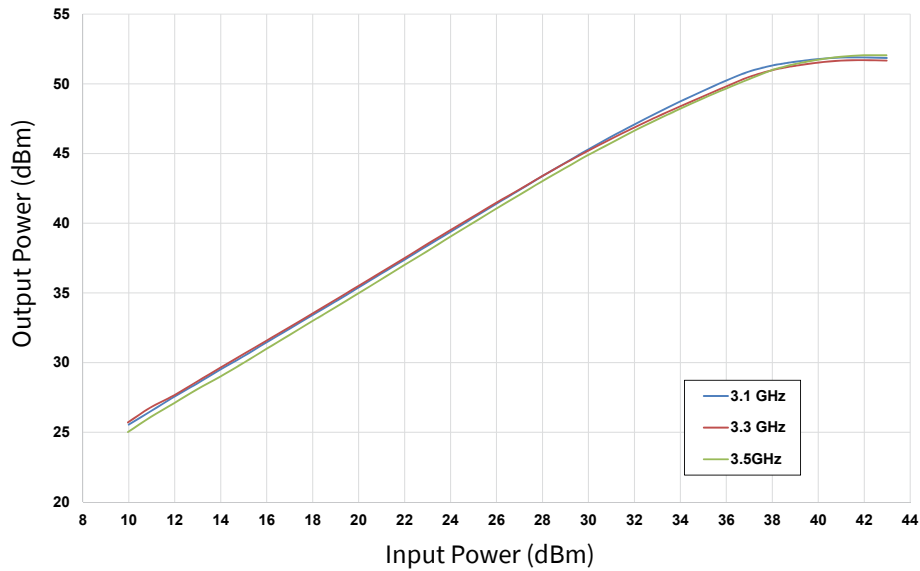

Figure 3. CGHV35120F Output Power vs Input Power Measured in CGHV35120F-AMP1
 $V_{DD} = 48\text{ V}$, $I_{DQ} = 220\text{ mA}$, $T_{PLATE} = 85^\circ\text{C}$, Pulse Width = $100\ \mu\text{s}$, Duty Cycle = 10%

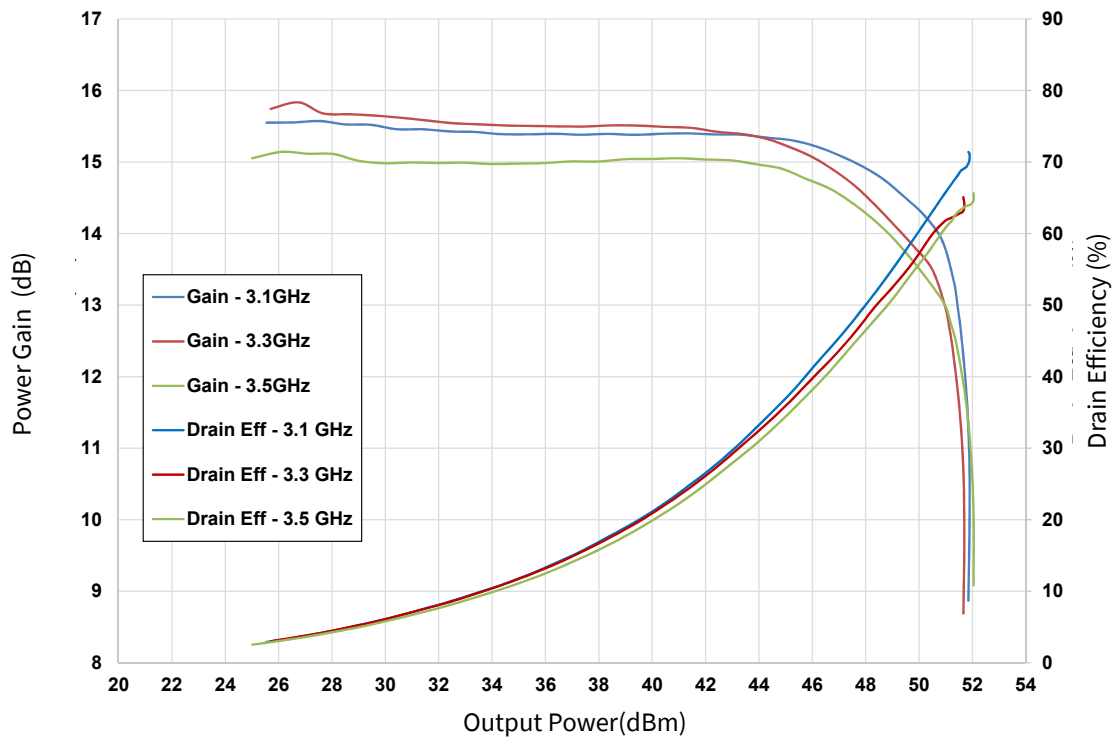

Figure 4. CGHV35120F Gain and Drain Efficiency vs Output Power Measured in CGHV35120F-AMP1
 $V_{DD} = 48\text{ V}$, $I_{DQ} = 220\text{ mA}$, $T_{PLATE} = 85^\circ\text{C}$, Pulse Width = $100\ \mu\text{s}$, Duty Cycle = 10%



Typical Performance

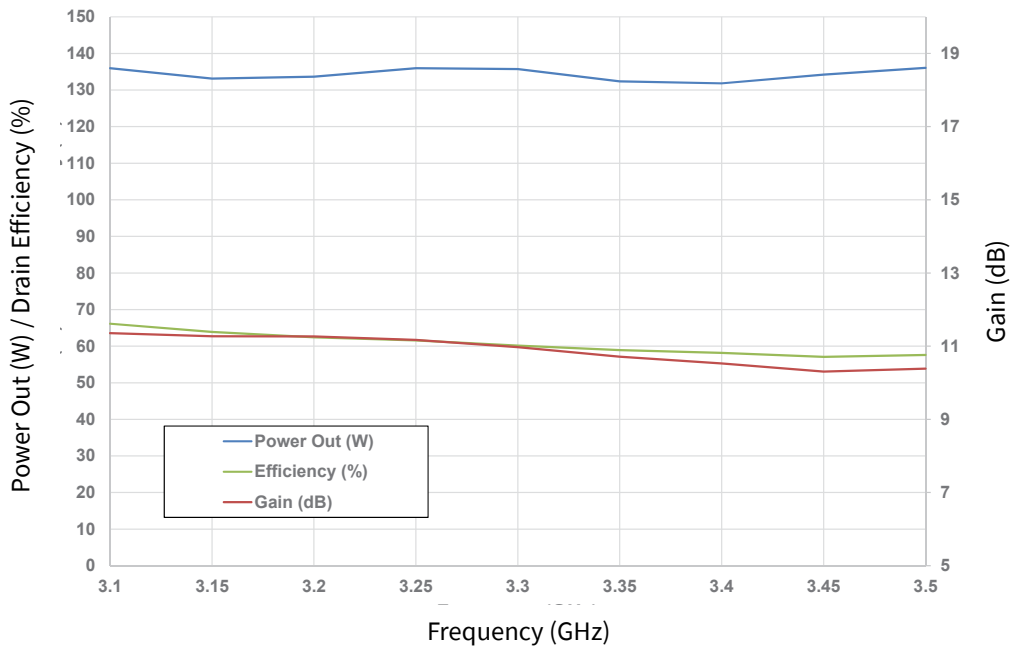

Figure 5. CGHV35120F Power Out/Drain Efficiency vs Frequency Measured in CGHV35120F-AMP1
 $V_{DD} = 48\text{ V}$, P_{SAT} where $I_G > 0$, Pulse Width = 1msec, Duty Cycle = 20%

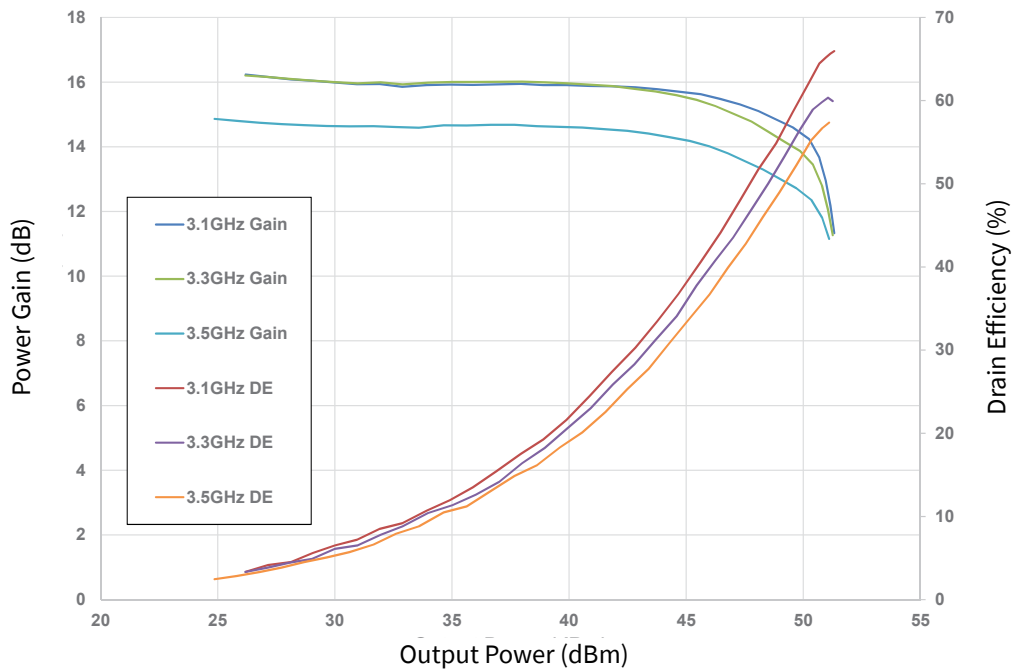

Figure 6. CGHV35120F Gain and Drain Efficiency vs Output Power Measured in CGHV35120F-AMP1
 $V_{DD} = 48\text{ V}$, $I_{DQ} = 220\text{ mA}$, $T_{PLATE} = 25^\circ\text{C}$, Pulse Width = 1msec, Duty Cycle = 20%



Typical Performance

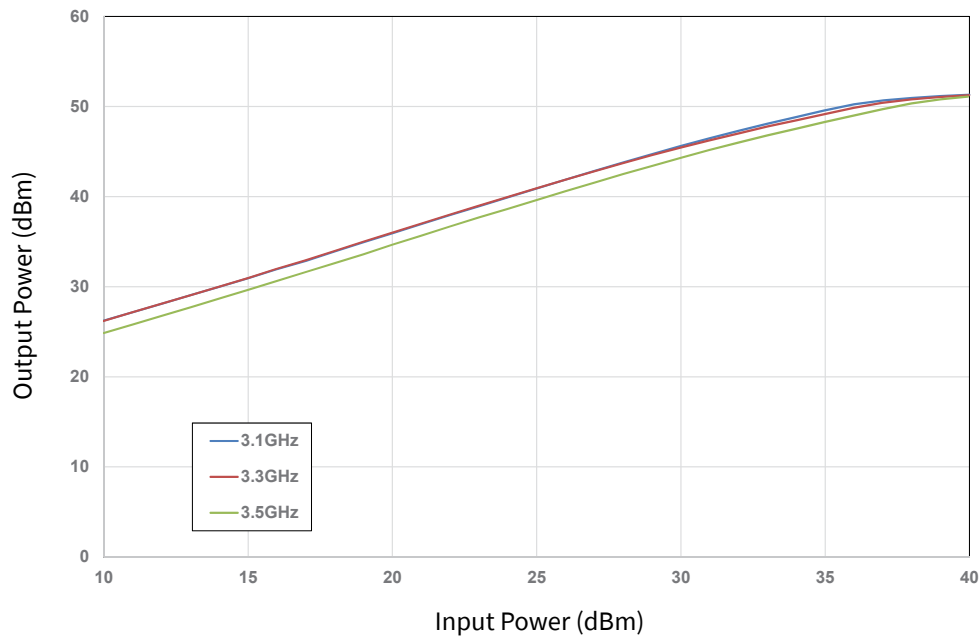

Figure 7. CGHV35120F Output Power vs Input Power Measured in CGHV35120F-AMP1
 $V_{DD} = 48\text{ V}$, $I_{DQ} = 220\text{ mA}$, $T_{PLATE} = 25^{\circ}\text{C}$, Pulse Width = 1msec, Duty Cycle = 20%

Electrostatic Discharge (ESD) Classifications

Parameter	Symbol	Class	Classification Level	Test Methodology
Human Body Model	HBM	1A	ANSI/ESDA/JEDEC JS-001 Table 3	JEDEC JESD22 A114-D
Charge Device Model	CDM	0CB	ANSI/ESDA/JEDEC JS-002 Table 3	JEDEC JESD22 C101-C



CGHV35120F Power Dissipation De-rating Curve

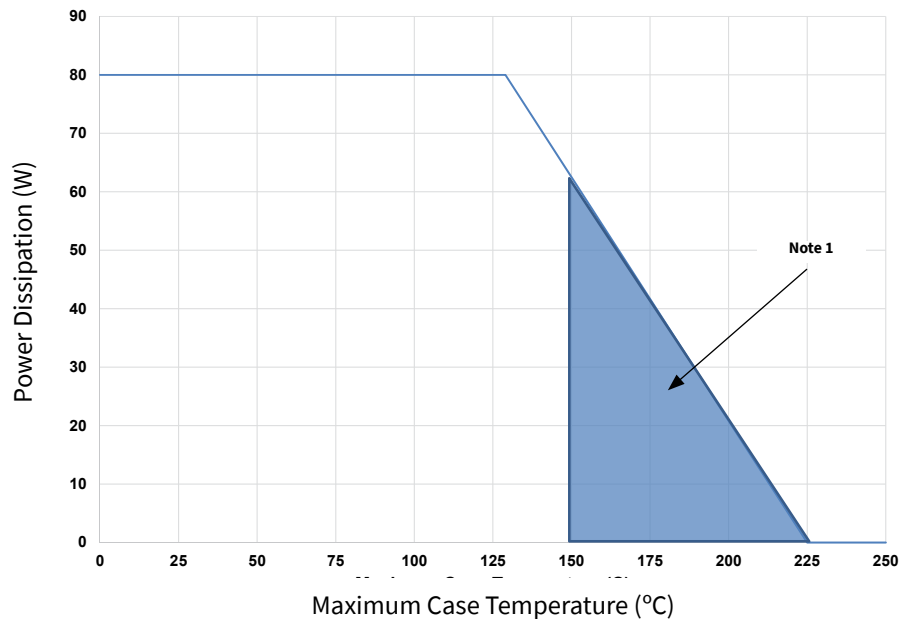

Note: Area exceeds Maximum Case Temperature (See Page 2)

CGHV35120F Bill of Materials

Designator	Description	Qty
R1	RES, 511 ohms, +/- 1%, 1/16W, 0603	1
R2	RES, 5.1, ohm, +/- 1%, 1/16W, 0603	1
C8	CAP, 10pF, +/- 1%, 250V, 0805, ATC	2
C2	CAP, 6.8pF, +/- 0.25 pF, 250V, 0603, ATC	1
C1, C3	CAP, 10.0pF, +/-5%, 250V, 0603, ATC	2
C4, C9	CAP, 470pF, 5%, 100V, 0603, X7R	2
C5, C10	CAP, 33000pF, 0805, 100V, X7R	2
C6	CAP, 10μF, 16V, TANTALUM	1
C7	CAP, 6.8pF, +/- 1%, 250V, 0805, ATC	1
C11	CAP, 1.0μF, 100V, 10%, X7R, 1210	1
C12	CAP, 33 μF, 20%, G CASE	1
C13	CAP, 3300 μF, +/-20%, 100V, ELECTROLYTIC	1
C14	CAP, 0.4pF, +/-0.1pF, 0603, ATC	1
J1, J2	CONN, SMA, PANEL MOUNT JACK, FLANGE, 4-HOLE, BLUNT POST, 20MIL	2
J3	HEADER RT>PLZ .1CEN LK 9POS	1
J4	CONNECTOR; SMB, Straight, JACK, SMD	1
W1	CABLE, 18 AWG, 4.2	1
	PCB, RO4350, 10 MIL THK, CGHV35120F	1
Q1	CGHV35120F	1



CGHV35120F-AMP1 Application Circuit Outline

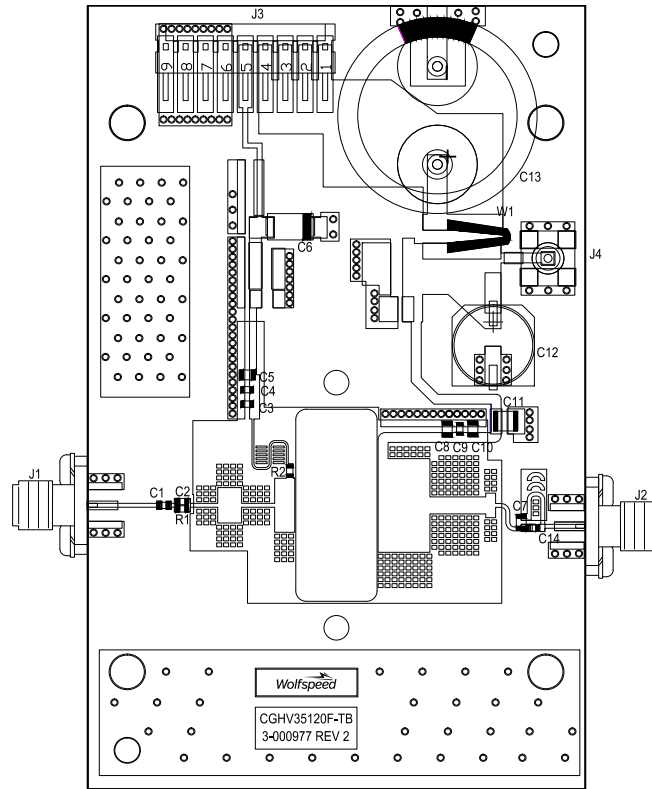

CGHV35120F-AMP1 Application Circuit Schematic

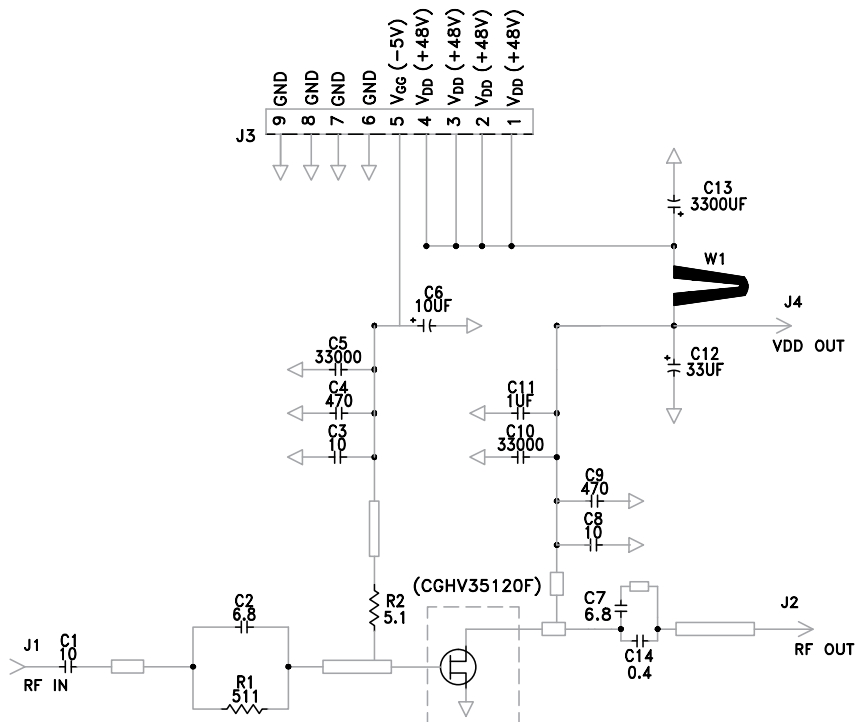



Product Dimensions CGHV35120F (Package Type — 440162)

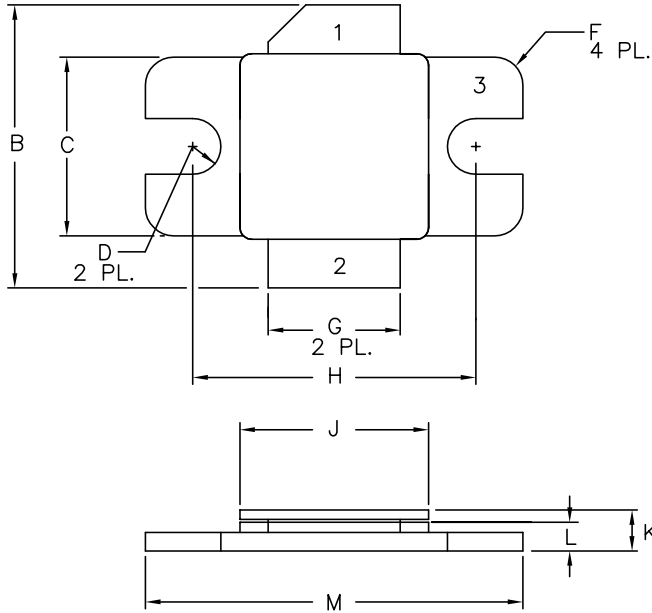

NOTES:

1. DIMENSIONING AND TOLERANCING PER ANSI Y14.5M, 1982.
2. CONTROLLING DIMENSION: INCH.
3. ADHESIVE FROM LID MAY EXTEND A MAXIMUM OF 0.020" BEYOND EDGE OF LID.
4. LID MAY BE MISALIGNED TO THE BODY OF THE PACKAGE BY A MAXIMUM OF 0.008" IN ANY DIRECTION.

DIM	INCHES		MILLIMETERS	
	MIN	MAX	MIN	MAX
A	.395	.405	10.03	10.29
B	.580	.620	14.73	15.75
C	.380	.390	9.65	9.91
D	.055	.065	1.40	1.65
E	.004	.006	0.10	0.15
F	.055	.065	1.40	1.65
G	.275	.285	6.99	7.24
H	.595	.605	15.11	15.37
J	.395	.405	10.03	10.29
K	.129	.149	3.28	3.78
L	.053	.067	1.35	1.70
M	.795	.805	20.19	20.45

- PIN 1. GATE
 PIN 2. DRAIN
 PIN 3. SOURCE



Part Number System

CGHV35120F



Table 1.

Parameter	Value	Units
Upper Frequency ¹	3.8	GHz
Power Output	120	W
Package	Flange	—

Note:

¹ Alpha characters used in frequency code indicate a value greater than 9.9 GHz. See Table 2 for value.

Table 2.

Character Code	Code Value
A	0
B	1
C	2
D	3
E	4
F	5
G	6
H	7
J	8
K	9
Examples:	1A = 10.0 GHz 2H = 27.0 GHz

Product Ordering Information

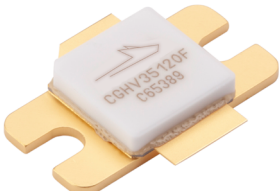
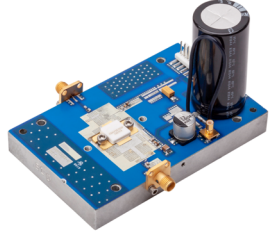
Order Number	Description	Unit of Measure	Image
CGHV35120F	GaN HEMT	Each	
CGHV35120F-AMP1	3.1 - 3.5 GHz test board with GaN HEMT installed	Each	

**For more information, please contact:**

4600 Silicon Drive
Durham, NC 27703 USA
Tel: +1.919.313.5300
www.wolfspeed.com/RF

Sales Contact
RFSales@wolfspeed.com

RF Product Marketing Contact
RFMarketing@wolfspeed.com

Notes & Disclaimer

Specifications are subject to change without notice. “Typical” parameters are the average values expected by Wolfspeed in large quantities and are provided for information purposes only. Wolfspeed products are not warranted or authorized for use as critical components in medical, life-saving, or life-sustaining applications, or other applications where a failure would reasonably be expected to cause severe personal injury or death. No responsibility is assumed by Wolfspeed for any infringement of patents or other rights of third parties which may result from use of the information contained herein. No license is granted by implication or otherwise under any patent or patent rights of Wolfspeed.

© 2019-2022 Wolfspeed, Inc. All rights reserved. Wolfspeed® and the Wolfstreak logo are registered trademarks and the Wolfspeed logo is a trademark of Wolfspeed, Inc.
PATENT: <https://www.wolfspeed.com/legal/patents>

The information in this document is subject to change without notice.