

FEMALE PLUG M12 90° ANGLED TO MALE PLUG M12 STRAIGHT

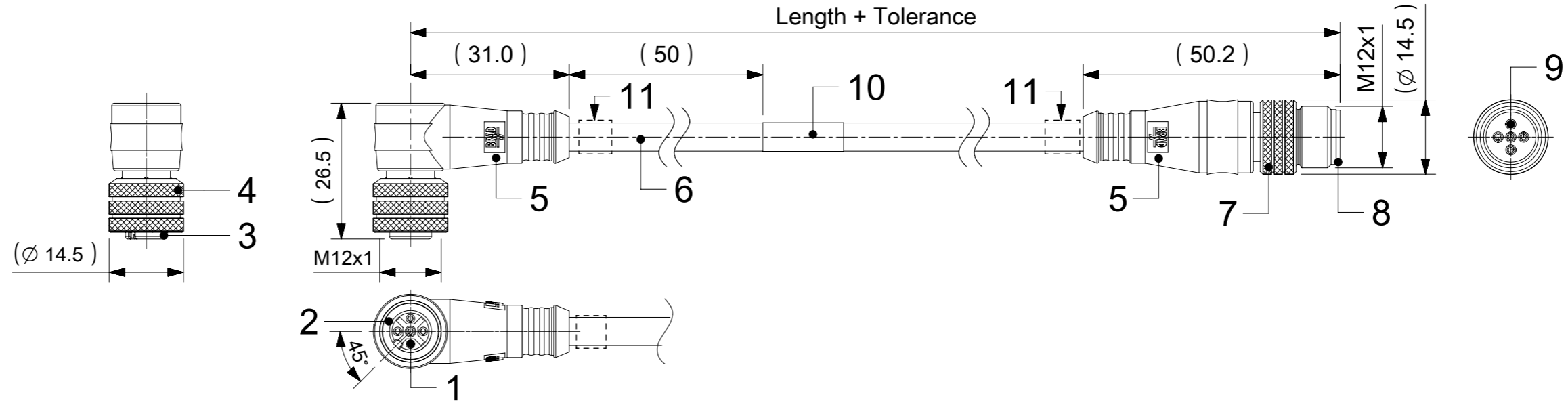

NOTES:

- RATED VOLTAGE: 3, 4 contacts 250V per IEC 60664
5 contacts 60V per IEC 60664
5 contacts 250V per UL 2238
8 contacts 30V per IEC 60664
- RATED CURRENT: 3, 4, 5 contacts 4A
8 contacts 2A
- PROTECTION CLASS: IP 67
- TEMPERATURE: -25°C / +85°C

* FOR CABLES Ixx USE PRINTING ON THE CABLE IN THE SAME MEASUREMENT LIKE FOR LABEL - ENGINEERING No



CONTACTS POSITION FRONT VIEW:

	3 CONTACTS		4 CONTACTS		5 CONTACTS		8 CONTACTS	
FEMALE								
MALE								
CONNECTIONS	PIN	WIRE	PIN	WIRE	PIN	WIRE	PIN	WIRE
	1	BROWN	1	BROWN	1	BROWN	1	WHITE
	2	---	2	WHITE	2	WHITE	2	BROWN
	3	BLUE	3	BLUE	3	BLUE	3	GREEN
	4	BLACK	4	BLACK	4	BLACK	4	YELLOW
			5	---	5	GREY OR GREEN/YELLOW	5	GREY
							6	PINK
							7	BLUE
						8	RED	

CODING REQUIRED TO IEC 61076-2-101

FOR OPTIONS SEE - NUMERICAL CODE - ON SHEET 2

ITEM	QTY.	DESCRIPTION	MATERIAL	FINISH
11	SEE PART LIST	ID CARRIER	PVC	TRANSPARENT
10	1	LABEL YELLOW	VINYL	---
	-	PRINTING FOR CABLES Ixx	---	---
9	3 / 4 / 5 / 8	CONTACT MALE	SEE PART LIST	SELECTIVE Au OVER Ni
8	1	INSERT MALE BLACK	SEE PART LIST	---
7	1	COUPLING NUT MALE	SEE PART LIST	---
6	-	CABLE	SEE SHEET 2	---
5	-	OVERMOLDING BLACK	SEE PART LIST	---
4	1	COUPLING NUT FEMALE	SEE PART LIST	---
3	1	INSERT FEMALE BLACK	SEE PART LIST	---
2	1	O-RING RED	FPM	---
1	3 / 4 / 5 / 8	CONTACT FEMALE	SEE PART LIST	SELECTIVE Au OVER Ni

FUNCTIONAL SYMBOLS	THIS DRAWING CONTAINS INFORMATION THAT IS PROPRIETARY TO MOLEX ELECTRONIC TECHNOLOGIES, LLC AND SHOULD NOT BE USED WITHOUT WRITTEN PERMISSION						
DIMENSION UNITS: mm SCALE: 1:1 GENERAL TOLERANCES (UNLESS SPECIFIED): ANGULAR TOL ± 1.0°	CURRENT REV DESC: REMOVED OBSOLETE PART NUMBERS AS PER PCN#510807.				EC NO: 726454 DRWN: LIKITV 2022/11/30 CHK'D: GGA 2022/11/30 APPR: GGA 2022/11/30		
DIVISIONAL SYMBOLS	4 PLACES ± 3 PLACES ± 2 PLACES ± 0.05 1 PLACE ± 0.3 0 PLACES ± 0.5		PRODUCT CUSTOMER DRAWING DOCUMENT NUMBER: 1200660973 DOC TYPE: PSD DOC PART: 000 REVISION: A10				
DRAFT WHERE APPLICABLE MUST REMAIN WITHIN DIMENSIONS		THIRD ANGLE PROJECTION	DRAWING: A3-SIZE	SERIES: 120066	MATERIAL NUMBER: SEE SHEET 3, 4	CUSTOMER: GENERAL MARKET	SHEET NUMBER: 1 OF 4

ENGINEERING NO. - NUMERICAL CODE (Available parts see PART LIST table. Other parts available upon request).

8 8 X 0 X 1 X X X X X X X X

OPTIONS

88=Micro-Change
M12x1
Double ended

Contacts:
3=3 Contacts
4=4 Contacts
5=5 Contacts
8=8 Contacts

Heads style:
031=Plug Female 90°
to Plug Male Straight
021=Plug Female 90°
to Plug Male Straight
with Female
Coupling Nut

Cable type: See Table

Units:
M=Meter
C=Centimeter

Length
Examples:
005=0.5 unit
010=1 unit
100=10 units

Overmold color:
Blank (Standard)=Black TPU
Blank=Yellow TPU for cables
A09, S19, S20, S26
Blank=Yellow TPE-E for cables
K03, K05
A=Grey / G=Black / Y=Yellow

Coupling Nut:
Blank (Standard)=Knurled Brass Ni Plated
1=Hexagonal Stainless steel
5=Knurled Derlin
7=Knurled Brass Ni Plated, Teflon Coated
Blank=7 for cables I20, I26, K03, K05, P82, S26
9=Knurled / Hexagonal Brass Ni Plated SW13

**COUPLING NUT
FEMALE MALE**

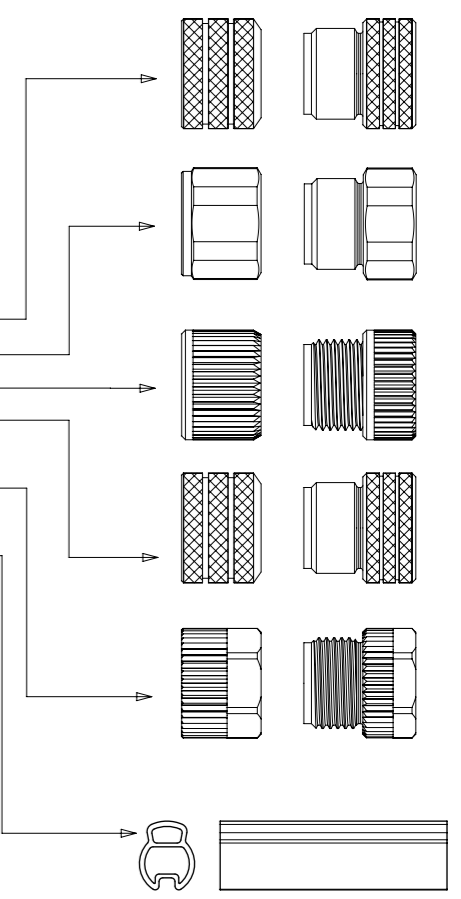

CABLE INFORMATION (for more information see Cable Data Sheet).

CABLE TYPE	NO. OF WIRES	CROSS SECTION	CABLE JACKET	UL	CSA	STATIC: TEMP. / BENDING RADIUS	DYNAMIC: TEMP. / BENDING RADIUS	DRAG CHAIN	SHIELD
I03	3 / 4 / 5	0.34mm ²	PVC CEI GREY	-	-	-30°C to +70°C	-5°C to +70°C	-	-
I20	3 / 4	0.34mm ²	PVC CEI GREY	-	-	-30°C to +70°C	-5°C to +70°C	-	YES
I26	5	0.34mm ²	PVC CEI GREY	-	-	-30°C to +70°C	-5°C to +70°C	-	YES
K03	4	18AWG	TPE YELLOW	UL ITC or PLC	I/II A/B 90°C/300V	max 105°C	-	-	-
K05	3 / 4 / 5	22AWG	TPE YELLOW	UL ITC or PLC	I/II A/B 90°C/300V	max 105°C	-	-	-
P82	3 / 4 / 5	0.34mm ²	PUR IRR ORANGE	-	-	-50°C to +105°C, >5xO.D.	-40°C to +105°C, >7.5xO.D.	-	-
S20	3 / 4 / 5	0.34mm ²	PVC YELLOW	UL 2661/1731	C22.2 II A 105°C/300V	-30°C to +105°C	-	-	YES
E02	3 / 4 / 5 / 8	0.25mm ²	PVC BLACK	UL 2464/1729	C22.2 I/II A/B 80°C/300V	-30°C to +80°C, 10xO.D.	-10°C to +80°C, 15xO.D.	-	-
E03	3 / 4 / 5	0.34mm ²	PVC BLACK	UL 2464/1729	C22.2 I/II A/B 80°C/300V	-30°C to +80°C, 10xO.D.	-10°C to +80°C, 15xO.D.	-	-
H09	3 / 4 / 5	0.34mm ²	PUR BLACK LSOH	UL 21198/10493	C22.2 I/II A/B 80°C/300V	-40°C to +80°C, 5xO.D.	-25°C to +80°C, 10xO.D.	2 000 000 cycles at 20°C, Temp. range +5°C to +60°C	-
P03	3 / 4 / 5	0.34mm ²	PUR / PVC BLACK	-	-	-30°C to +80°C, >7xO.D.	-5°C to +80°C, >15xO.D.	-	-
H08	8	0.25mm ²	PUR BLACK LSOH	UL 21198/10493	UL 21198/10493	-40°C to +80°C, >5xO.D.	-25°C to +80°C, >10xO.D.	2 000 000 cycles, Temp max 60°C	-
P02	8	0.25mm ²	PUR / PVC BLACK	-	-	-30°C to +80°C, >7xO.D.	-5°C to +80°C, >15xO.D.	-	-

CABLE LENGTH TOLERANCES

OVER	UP TO AND INCLUDING	TOLERANCES
0	305mm	+19mm
305mm	915mm	+45mm
915mm	1830mm	+56mm
1830mm	3660mm	+89mm
3660mm	7320mm	+165mm
7320mm	14640mm	+317mm
14640mm	30500mm	+610mm
30500mm	>	+2% of finished length

FUNCTIONAL SYMBOLS	THIS DRAWING CONTAINS INFORMATION THAT IS PROPRIETARY TO MOLEX ELECTRONIC TECHNOLOGIES, LLC AND SHOULD NOT BE USED WITHOUT WRITTEN PERMISSION		CURRENT REV DESC: REMOVED OBSOLETE PART NUMBERS AS PER PCN#510807.	molex		
	THIS DRAWING CONTAINS INFORMATION THAT IS PROPRIETARY TO MOLEX ELECTRONIC TECHNOLOGIES, LLC AND SHOULD NOT BE USED WITHOUT WRITTEN PERMISSION	SCALE				
GENERAL TOLERANCES (UNLESS SPECIFIED)	mm	1:1	EC NO: 726454	CSE M12 XP AC FE RA MA STR XM DE		
ANGULAR TOL ± 1.0°	4 PLACES ±		DRWN: LIKITV	2022/11/30		
DIVISIONAL SYMBOLS	3 PLACES ±		CHK'D: GGA	2022/11/30		
	2 PLACES ± 0.05		APPR: GGA	2022/11/30		
	1 PLACE ± 0.3		INITIAL REVISION:	PRODUCT CUSTOMER DRAWING		
	0 PLACES ± 0.5		DRWN: JMARSZALEK	DOCUMENT NUMBER	DOC TYPE	DOC PART
			APPR: RSILLER	1200660973	PSD	000
DRAFT WHERE APPLICABLE MUST REMAIN WITHIN DIMENSIONS	THIRD ANGLE PROJECTION	DRAWING	SERIES	MATERIAL NUMBER	CUSTOMER	REVISION
		A3-SIZE	120066	SEE SHEET 3, 4	GENERAL MARKET	A10
						SHEET NUMBER
						2 OF 4

PART LIST

No.	Part No.	Engineering No.	Cable Length
1	1200060052	884031I20M005	0.5m
2	1200060053	884031I20M010	1m
3	1200060054	884031I20M015	1.5m
4	1200060055	884031I20M020	2m
5	1200070132	883031I03M003	0.3m
6	1200070133	883031I03M006	0.6m
7	1200070134	883031I03M010	1m
8	1200070136	883031I03M020	2m
9	1200070137	883031I03M030	3m
10	1200070138	883031I03M050	5m
11	1200070152	883031S20M010	1m
12	1200070153	883031S20M020	2m
13	1200070156	883031S20M050	5m
14	1200070522	884031I03M020	2m
15	1200070523	884031I03M030	3m
16	1200070534	884031S20M030	3m
17	1200070651	884031I03M006	0.6m
18	1200070768	884031S20M050	5m
19	1200070783	884031S20M100H	10m
20	1200071138	884031S20M010H	1m
21	1200071139	884031S20M020H	2m
22	1200071164	884031S20M003H	0.3m
23	1200071179	884031S20M006H	0.6m
24	1200071183	884031S20M030H	3m
25	1200071189	884031S20M050H	5m
26	1200071200	884031S20M015H	1.5m
27	1200071236	884031S20M005H	0.5m
28	1200071280	884031S20M040H	4m
29	1200071341	884031I20M030	3m
30	1200071493	883031P82M0507	5m
31	1200071832	884031I20M050	5m
32	1200071833	884031I20M100	10m
33	1200071893	884031S20M100	10m
34	1200071994	885031P82M0307	3m
35	1200072696	883031S20M010H	1m

No.	Part No.	Engineering No.	Cable Length
36	1200072725	885031I26M005	0.5m
37	1200072726	885031I26M010	1m
38	1200659070	884031I20M010Y	1m
39	1200659071	884031I20M015Y	1.5m
40	1200659115	884031I20M005Y	0.5m
41	1200660374	884031K05M005	0.5m
42	1200660375	884031K05M006	0.6m
43	1200660376	884031K05M010	1m
44	1200660377	884031K05M015	1.5m
45	1200660378	884031K05M020	2m
46	1200660379	884031K05M030	3m
47	1200660380	884031K05M040	4m
48	1200660381	884031K05M050	5m
49	1200660382	884031K05M060	6m
50	1200660383	884031S20M010	1m
51	1200660546	884031K05M100	10m
52	1200661046	885031K03M010	1m
53	1200661047	885031K03M020	2m
54	1200661049	885031K03M040	4m
55	1200661050	885031K03M050	5m
56	1200661769	884031K05M150	15m
57	1200669556	885031P03M015	1.5m
58	1200660969	884031K03M003	0.3m
59	1200661481	884031K03M120	12m
60	1200660971	884031K03M006	0.6m
61	1200660973	884031K03M010	1m
62	1200660975	884031K03M015	1.5m
63	1200660976	884031K03M020	2m
64	1200660977	884031K03M030	3m
65	1200660978	884031K03M040	4m
66	1200660980	884031K03M050	5m
67	1200660982	884031K03M060	6m
68	1200660983	884031K03M070	7m
69	1200660984	884031K03M090	9m
70	1200660985	884031K03M100	10m

No.	Part No.	Engineering No.	Cable Length
71	1200665039	884031S20M003	0.3m
72	1200665053	884031S20M060H	6m
73	1200665074	884031K05M080	8m
74	1200668052	883031S20M006	0.6m
75	1200668071	884031S20M020	2m
76	1200668191	883031S20M030	3m
77	1200668237	883031S20M100	10m
78	1200668258	883031I03M080	8m
79	1200668287	884031I20M025	2.5m
80	1200668667	884031I20M030Y	3m
81	1200070443	884021S20M003	0.3m
82	1200070444	884021S20M006	0.6m
83	1200070445	884021S20M010	1m
84	1200070446	884021S20M020	2m
85	1200070447	884021S20M030	3m
86	1200070449	884021S20M050	5m
87	1200668160	883021S20M010	1m
88	1200668608	883031E02M020	2m
89	1200668613	883031E02M030	3m
90	1200659035	883031E02M050	5m
91	1200668612	883031E02M100	10m
92	1200668908	883031E03M003H	0.3m
93	1200070118	883031E03M006	0.6m
94	1200668909	883031E03M006H	0.6m
95	1200070119	883031E03M010	1m
96	1200668910	883031E03M010H	1m
97	1200070945	883031E03M015	1.5m
98	1200668967	883031E03M015H	1.5m
99	1200070121	883031E03M020	2m
100	1200072445	883031E03M020H	2m
101	1200070123	883031E03M030	3m
102	1200668911	883031E03M030H	3m
103	1200072164	883031E03M040	4m
104	1200668968	883031E03M040H	4m
105	1200070125	883031E03M050	5m

Pos.	Part No.	Engineering No.	Cable Length
106	1200668912	883031E03M050H	5m
107	1200668175	883031E03M060	6m
108	1200070127	883031E03M100	10m
109	1200658762	883031H09M006	0.6m
110	1200658763	883031H09M010	1m
111	1200658764	883031H09M020	2m
112	1200658765	883031H09M030	3m
113	1200669349	883031H09M030H	3m
114	1200658766	883031H09M040	4m
115	1200658767	883031H09M050	5m
116	1200658768	883031H09M100	10m
117	1200070140	883031P03M003	0.3m
118	1200070141	883031P03M006	0.6m
119	1200070142	883031P03M010	1m
120	1200668324	883031P03M010G	1m
121	1200071121	883031P03M010H	1m
122	1200070143	883031P03M020	2m
123	1200668325	883031P03M020G	2m
124	1200668753	883031P03M020H	2m
125	1200070144	883031P03M030	3m
126	1200668326	883031P03M030G	3m
127	1200070145	883031P03M050	5m
128	1200668520	883031P03M070	7m
129	1200070146	883031P03M100	10m
130	1200070507	884031E03M003	0.3m
131	1200070508	884031E03M006	0.6m
132	1200070509	884031E03M010	1m
133	1200668361	884031E03M015	1.5m
134	1200070511	884031E03M020	2m
135	1200070512	884031E03M030	3m
136	1200669260	884031E03M030H	3m
137	1200070904	884031E03M050	5m
138	1200071157	884031E03M060	6m
139	1200071278	884031E03M100	10m
140	1200072011	884031E03M200	20m
141	1200668669	884031H09M006	0.6m
142	1200668846	884031H09M008	0.8m

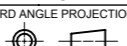
FUNCTIONAL SYMBOLS	THIS DRAWING CONTAINS INFORMATION THAT IS PROPRIETARY TO MOLEX ELECTRONIC TECHNOLOGIES, LLC AND SHOULD NOT BE USED WITHOUT WRITTEN PERMISSION	SCALE		CURRENT REV DESC: REMOVED OBSOLETE PART NUMBERS AS PER PCN#510807.	
	$\nabla_A = 0$ $\nabla_E = 0$ $\nabla_P = 0$	mm	1:1		
DIVISIONAL SYMBOLS	GENERAL TOLERANCES (UNLESS SPECIFIED)		EC NO: 726454		PRODUCT CUSTOMER DRAWING DOCUMENT NUMBER: 1200660973 DOC TYPE: PSD DOC PART: 000 REVISION: A10
	ANGULAR TOL ± 1.0°		2022/11/30		
	4 PLACES ±	DRWN: LIKITV		2022/11/30	
	3 PLACES ±	CHK'D: GGA		2022/11/30	
	2 PLACES ± 0.05	APPR: GGA		2022/11/30	
1 PLACE ± 0.3	INITIAL REVISION:		2016/10/06		
0 PLACES ± 0.5	DRWN: JMARSZALEK		2016/12/08		
DRAFT WHERE APPLICABLE MUST REMAIN WITHIN DIMENSIONS		THIRD ANGLE PROJECTION	DRAWING	SERIES	MATERIAL NUMBER
			A3-SIZE	120066	SEE PART LIST
					CUSTOMER
					GENERAL MARKET
					SHEET NUMBER
					3 OF 4

Pos.	Part No.	Engineering No.	Cable Length
143	1200668210	884031H09M009	0.9m
144	1200668484	884031H09M010	1m
145	1200668848	884031H09M013	1.3m
146	1200668488	884031H09M015	1.5m
147	1200668845	884031H09M018	1.8m
148	1200668212	884031H09M020	2m
149	1200668847	884031H09M021	2.1m
150	1200668215	884031H09M030	3m
151	1200668670	884031H09M050	5m
152	1200668671	884031H09M100	10m
153	1200070526	884031P03M003	0.3m
154	1200070527	884031P03M006	0.6m
155	1200060056	884031P03M010	1m
156	1200060057	884031P03M020	2m
157	1200070529	884031P03M030	3m
158	1200071187	884031P03M050	5m
159	1200072012	884031P03M100	10m
160	1300288001	885031D12M020	2m
161	1200668658	885031E02M020	2m
162	1200668610	885031E02M050	5m
163	1200668660	885031E02M100	10m
164	1200668339	885031E03M006	0.6m
165	1200668189	885031E03M010	1m
166	1200668278	885031E03M020	2m
167	1200668340	885031E03M030	3m
168	1200668279	885031E03M050	5m
169	1200668653	885031E03M070	7m
170	1200668348	885031E03M100	10m
171	1200668761	885031E03M150	15m
172	1200669229	885031H09C250	25m
173	1200668512	885031H09M006	0.6m
174	1200668496	885031H09M010	1m
175	1200668513	885031H09M020	2m
176	1200668514	885031H09M030	3m
177	1200668515	885031H09M050	5m
178	1200668516	885031H09M100	10m
179	1200073085	885031P03M006	0.6m
180	1200668188	885031P03M010	1m
181	1200072376	885031P03M0105	1m
182	1200070917	885031P03M020	2m
183	1200668091	885031P03M025	2.5m
184	1200070919	885031P03M030	3m
185	1200668273	885031P03M050	5m
186	1200073086	885031P03M100	10m
187	1200070434	884021E03M020	2m
188	1200658319	888031H08M050	5m
189	1200668673	888031E02M0041	0.4m
190	1200668849	888031P02M150	15m

Pos.	Part No.	Engineering No.	Cable Length
191	1200656208	888031H08C250	2.5m
192	1200656209	888031H08M005	0.5m
193	1200656210	888031H08M008	0.8m
194	1200656211	888031H08M012	1.2m
195	1200656212	888031H08M015	1.5m
196	1200070057	883021E03M006	0.6m
197	1200070058	883021E03M020	2m
198	1200070439	884021P03M006	0.6m
199	1200070440	884021P03M010	1m
200	1200070441	884021P03M020	2m
201	1200070442	884021P03M030	3m
202	1200070870	883021P03M050	5m
203	1200072191	883021E03M030	3m
204	1200072198	883021E03M050	5m
205	1200665038	884021E03M050	5m
206	1200668061	884021E03M006	0.6m
207	1200668219	884021E03M030	3m
208	1200668673	888031E02M0041	0.4m
209	1200669541	884031P03M015	1.5m
210	1200669885	884031E03M004	0.4m
211	1200669886	884031E03M005	0.5m
212	1200669887	884031E03M013	1.3m
213	1200669888	884031E03M080	8m

THIS DRAWING CONTAINS INFORMATION THAT IS PROPRIETARY TO MOLEX ELECTRONIC TECHNOLOGIES, LLC AND SHOULD NOT BE USED WITHOUT WRITTEN PERMISSION									
FUNCTIONAL SYMBOLS	DIMENSION UNITS	SCALE	CURRENT REV DESC: REMOVED OBSOLETE PART NUMBERS AS PER PCN#510807.						
$\nabla_A = 0$	mm	1:1	 CSE M12 XP AC FE RA MA STR XM DE						
$\nabla_E = 0$	GENERAL TOLERANCES (UNLESS SPECIFIED)								
$\nabla_F = 0$	ANGULAR TOL $\pm 1.0^\circ$		EC NO: 726454						
DIVISIONAL SYMBOLS	4 PLACES	\pm	DRWN: LIKITV 2022/11/30						
	3 PLACES	\pm	CHK'D: GGA 2022/11/30						
	2 PLACES	± 0.05	APPR: GGA 2022/11/30						
	1 PLACE	± 0.3	INITIAL REVISION:						
	0 PLACES	± 0.5	DRWN: JMARSZALEK 2016/10/06						
DRAFT WHERE APPLICABLE MUST REMAIN WITHIN DIMENSIONS			THIRD ANGLE PROJECTION		DRAWING	SERIES	MATERIAL NUMBER	CUSTOMER	SHEET NUMBER
					A3-SIZE	120066	SEE PART LIST	GENERAL MARKET	4 OF 4

DOCUMENT STATUS	P1	RELEASE DATE	2022/11/30	11:33:47
-----------------	----	--------------	------------	----------

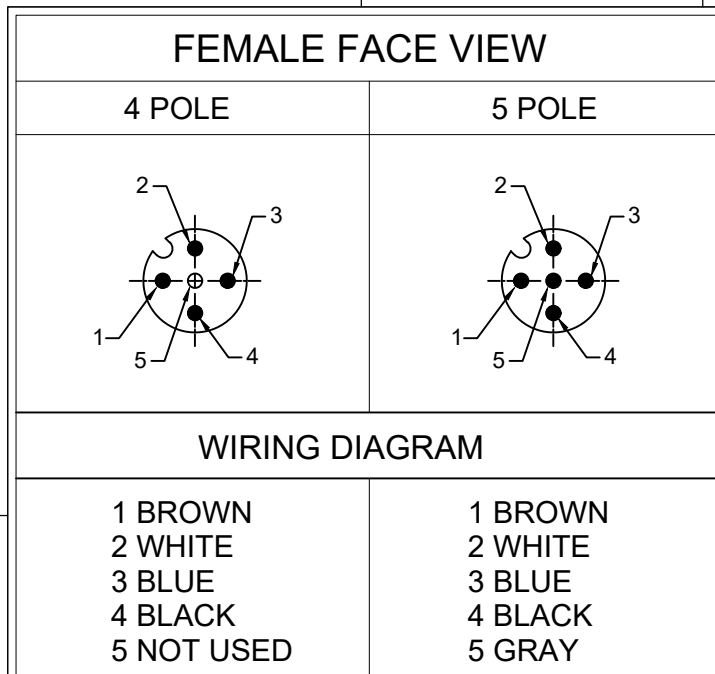

PART NO	ENGINEERING NO.	FINISHED LENGTH	POLES	CABLE DIA.
1200660969	884031K03M003	0.3M [1FT]	4	.26/6.6
1202010015	884031K03M200	20M [65FT 7 IN]		
1200661045	885031K03M005	0.5M [1FT 8 IN]	5	.28/7.1
1200661961	885031K03M200	20M [65FT 7 IN]		

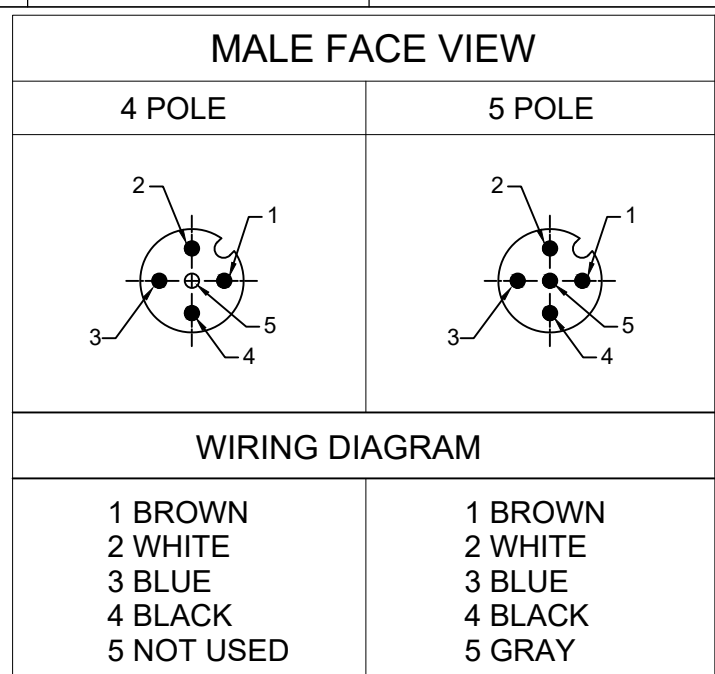

- NOTES:**
- MATERIAL: AS NOTED
 - FINISH: AS NOTED
 - ELECTRICAL:
VOLTAGE: 250V
CURRENT: 4A
 - TEMP RATING: -20°TO +105°C
 - PROTECTION: IP67 (WHEN MATED)
 - COUPLING THREAD: M12X1
 - UL RECOGNIZED FILE: E152210
CSA CERTIFIED FILE: LR6837
 - ALL DIMENSIONS ARE FOR REFERENCE UNLESS TOLERANCED OR NOTED OTHERWISE

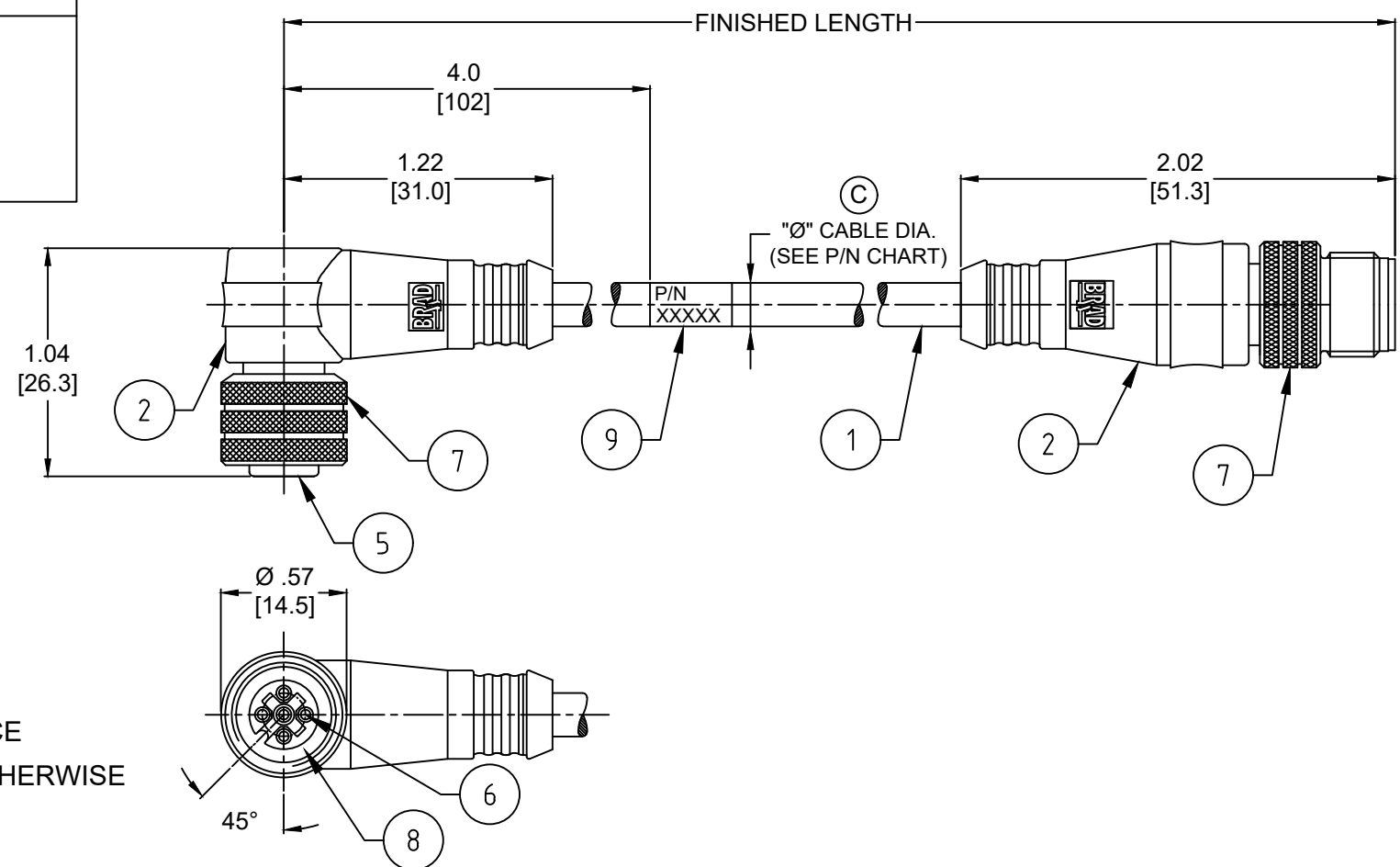

CABLE FLEX CHARACTERISTICS

TORSIONAL FLEX TEST	10 MILLION CYCLES PER MIL-C-13777G
BEND FLEX TEST	10 MILLION CYCLES PER MIL-C-13777G
WELD SLAG RESISTANCE	WOODHEAD STANDARD S-300

PART NO. MATRIX

884031K03M003

POLES (4 & 5)

FINISHED LENGTH
M005 = 0.5 METER
M010 = 1 METER
M100 = 10 METER

CABLE LENGTH TOLERANCES

<.3M [1FT]:	+19mm-0 [+ .75in-0]
.3 - .9M [1 - 3FT]:	+44.5mm-0 [+1.75in-0]
.9 - 1.8M [3 - 6FT]:	+55.6mm-0 [+2.19in-0]
1.8 - 3.7M [6 - 12FT]:	+88.9mm-0 [+3.50in-0]
3.7 - 7.3M [12 - 24FT]:	+165.1mm-0 [+6.50in-0]
7.3-14.6M [24 - 48FT]:	+317.5mm-0 [+12.50in-0]
14.6 - 30.5M [48-100FT]:	+622.3mm-0 [+24.50in-0]
OVER 30M [100FT]	+2% OF FINISHED LENGTH

ITEM	DESCRIPTION	MATERIAL	FINISH
9	WRAP LABEL	VINYL	BLACK/YELLOW
8	O-RING	VITON	RED
7	COUPLER	BRASS	TEFLON/NICKEL
6	CONTACT SOCKET	COPPER ALLOY	GOLD OVER NICKEL
5	INSERT (FEMALE)	PUR	BLACK
4	CONTACT PIN	COPPER ALLOY	GOLD OVER NICKEL
3	INSERT (MALE)	PUR	BLACK
2	OVERMOLD	TPC	YELLOW
1	CABLE #18/4-5 AWG	TPE JACKET	YELLOW

FUNCTIONAL SYMBOLS $F_A=0$ $F_V=0$ $F_P=0$	THIS DRAWING CONTAINS INFORMATION THAT IS PROPRIETARY TO MOLEX ELECTRONIC TECHNOLOGIES, LLC AND SHOULD NOT BE USED WITHOUT WRITTEN PERMISSION		molex		
	DIMENSION UNITS INCH/MM	SCALE NTS	MICRO-CHANGE CORDSET, M12 4-5 POLE, FEMALE 90DEG - MALE STRAIGHT, SINGLE KEY, #18 AWG TPE HI-FLEX		
	GENERAL TOLERANCES (UNLESS SPECIFIED)		PRODUCT CUSTOMER DRAWING		
	DIVISIONAL SYMBOLS		DOCUMENT NUMBER: SD-120066-021 DOC TYPE: PSD DOC PART: 001 REVISION: C		
DRAFT WHERE APPLICABLE MUST REMAIN WITHIN DIMENSIONS		THIRD ANGLE PROJECTION	DRAWING: A3-SIZE	SERIES: 120066	
MATERIAL NUMBER: SEE CHART		CUSTOMER: GENERAL MARKET		SHEET NUMBER: 1 OF 1	