

ASSEMBLY WITHOUT CAP

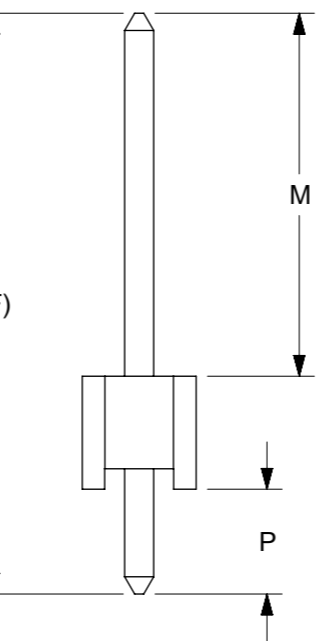
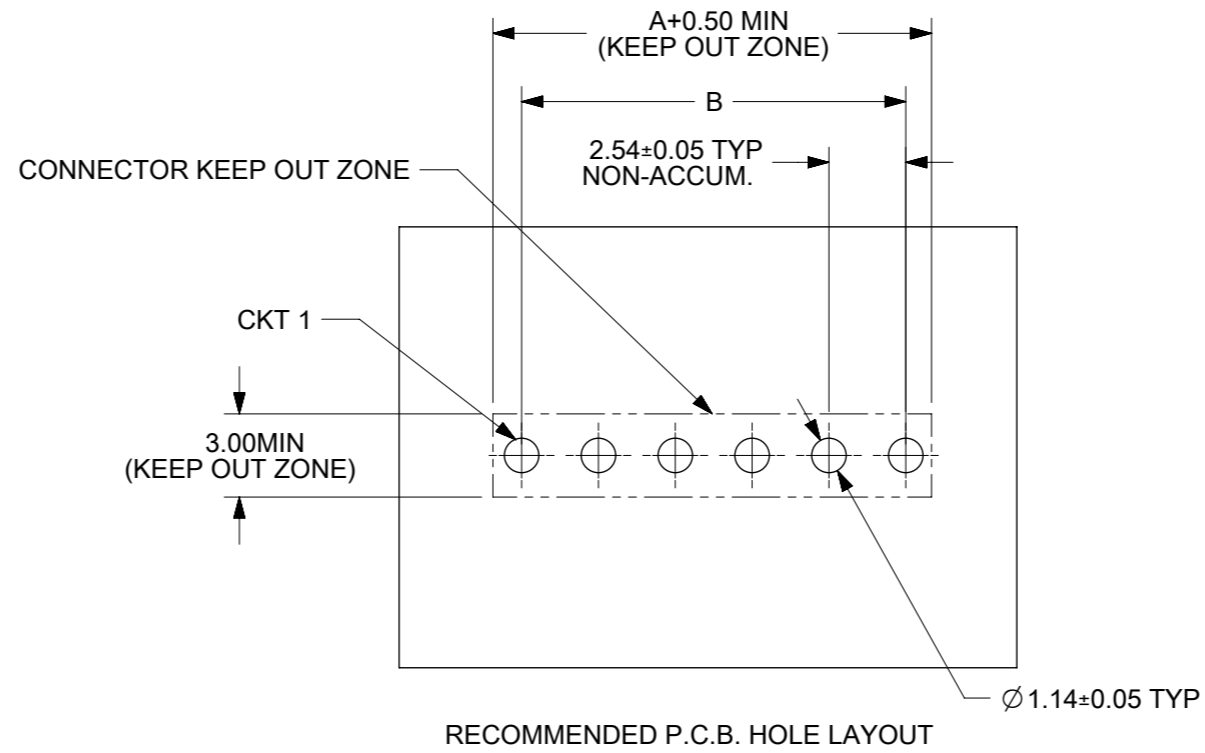
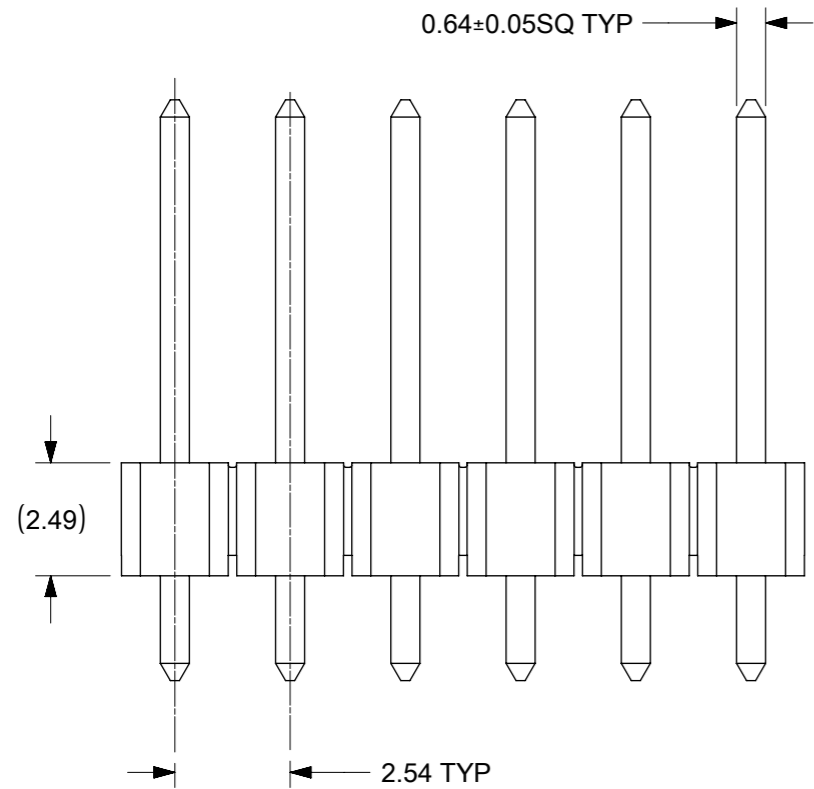
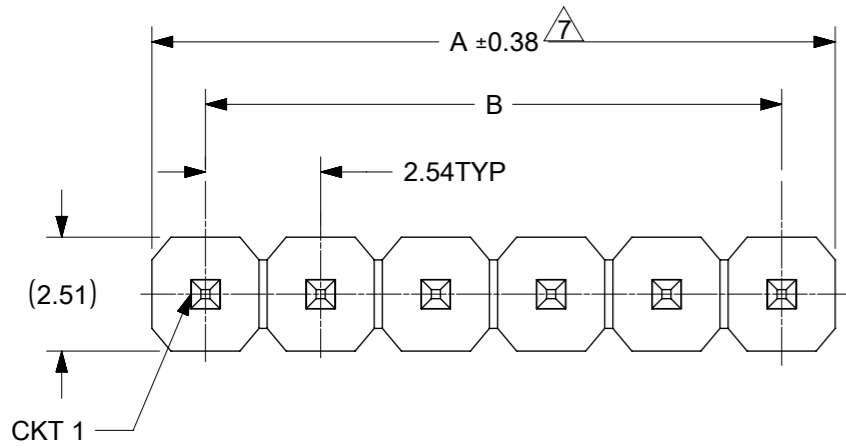

NOTES

1. MATERIAL:
HSG: NYLON, GLASS-FILLED, UL94V-0 COLOR: BLACK
PIN: 0.64MM SQ, COPPER ALLOY
2. PLATING TYPE:
 - (1) GOLD FLASH OVER
1.25µm MIN. NICKEL OVERALL.
 - (2) GOLD FLASH ON CONTACT AND
2.50µm MIN. TIN ON SOLDER TAIL OVER
1.25µm MIN. NICKEL OVERALL.
 - (3) 0.38µm MIN. GOLD PLATE ON CONTACT AND
2.00µm MIN. TIN ON SOLDER TAIL OVER
1.25µm MIN. NICKEL OVERALL.
 - (4) 0.75µm MIN. GOLD PLATE ON CONTACT AND
2.00µm MIN. TIN ON SOLDER TAIL OVER
1.25µm MIN. NICKEL OVERALL.
 - (5) 2.50µm MIN TIN OVERALL
1.25µm MIN NICKEL OVERALL
3. PRODUCT SPECIFICATION: PS-87920-019
4. PACKAGING TYPE: SEE TABLE
5. WAFER TO BE FLAT WITHIN 0.003 mm/mm
6. RECOMMENDED PCB THICKNESS IS 1.60mm ± 0.10
- △ IRREGULAR CIRCUIT CUTOFF WITHIN BREAKAWAY SECTION IS PERMISSIBLE. CUTTING OR CHIPPING OF THE MAIN BODY IS NOT ACCEPTABLE
8. THE ABOVE CKT 6 IS FOR ILLUSTRATION PURPOSE ONLY
9. PACKAGING SPECIFICATION:
TRAY: PK-89990-489
BULK: PK-89990-491
T&R : PK-87898-400
TUBE: PK-89990-934
10. REFER SHEET 2 FOR CAP LOCATION.

FUNCTIONAL SYMBOLS FA = 0 FE = 0 FP = 0	THIS DRAWING CONTAINS INFORMATION THAT IS PROPRIETARY TO MOLEX ELECTRONIC TECHNOLOGIES, LLC AND SHOULD NOT BE USED WITHOUT WRITTEN PERMISSION		CURRENT REV DESC:		molex	
	DIMENSION UNITS: mm NTS		SCALE: NTS			CUSTOM HEADER 2.54MM PITCH, SINGLE ROW SINGLE WAFER, T/H HEADER
	GENERAL TOLERANCES (UNLESS SPECIFIED)					
	DIVISIONAL SYMBOLS					PRODUCT CUSTOMER DRAWING
4 PLACES ±		3 PLACES ±		2 PLACES ± 0.2		
1 PLACE ±		0 PLACES ±		ANGULAR TOL ± 3.0°		
DRAFT WHERE APPLICABLE MUST REMAIN WITHIN DIMENSIONS		THIRD ANGLE PROJECTION		DRAWING SERIES		
P1		RELEASE DATE 2023/03/09 04:23:59		DOCUMENT NUMBER SD-87891-001		
9		8		PSD 000 D19		
3		4		MATERIAL NUMBER SEE TABLE		
2		5		CUSTOMER GENERAL MARKET		
1		6		SHEET NUMBER 1 OF 5		

CAP INFORMATION- CAP OPTION A

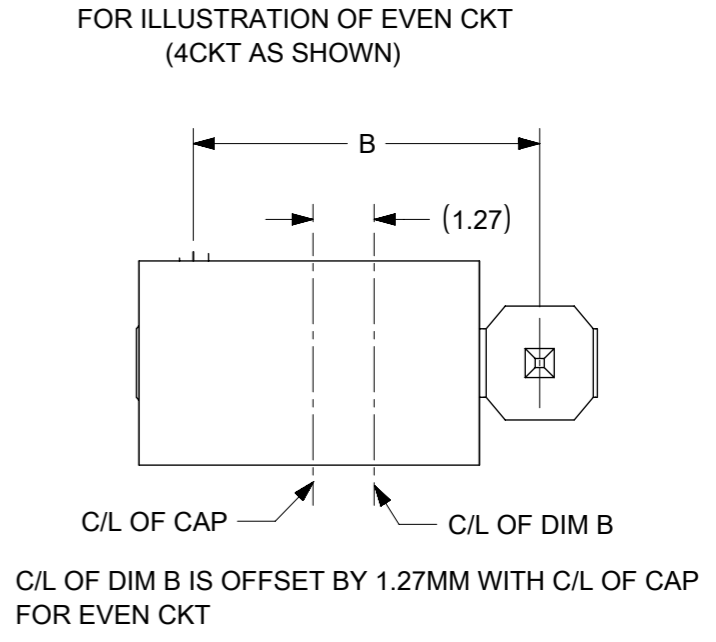
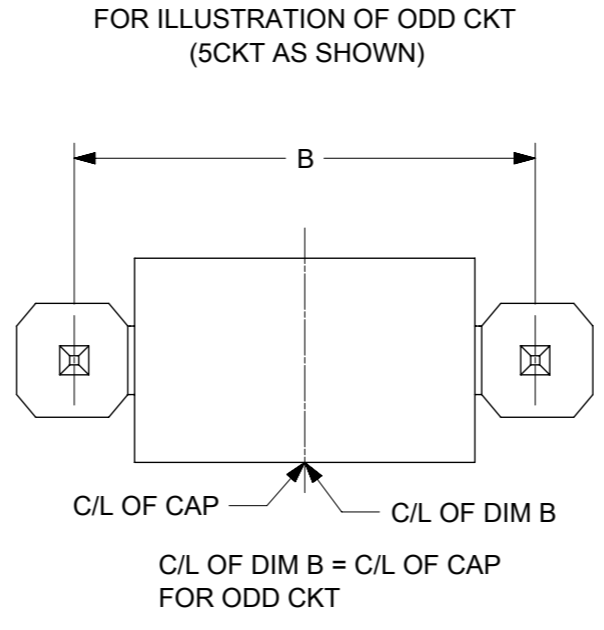
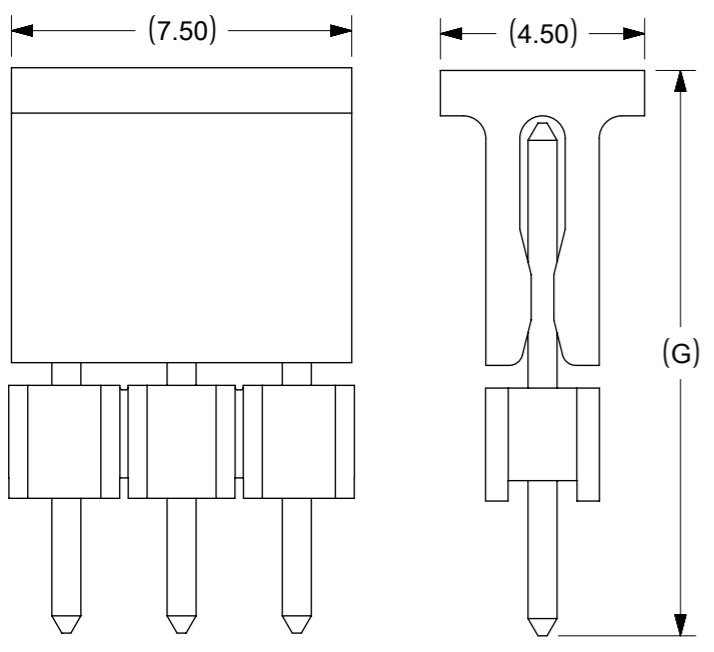

CAP INFORMATION- CAP OPTION B

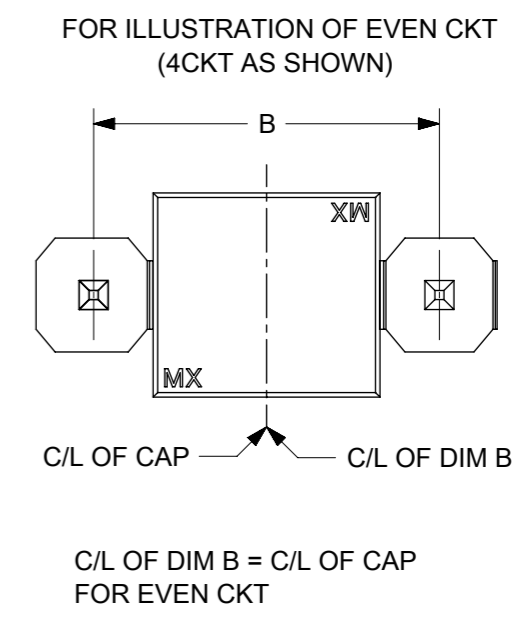
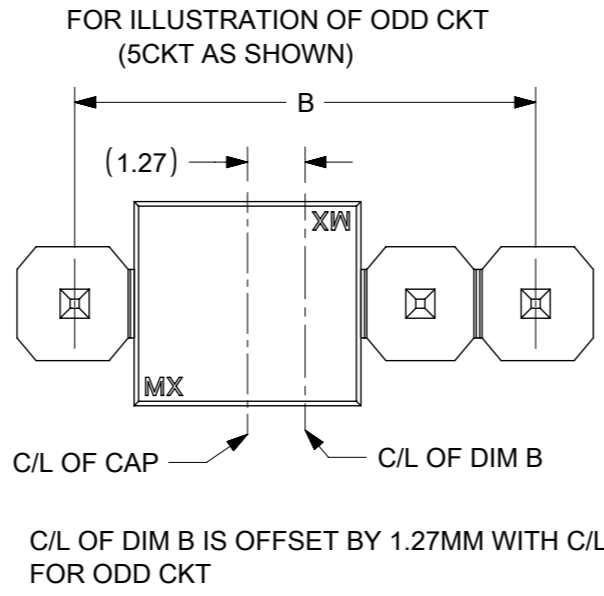
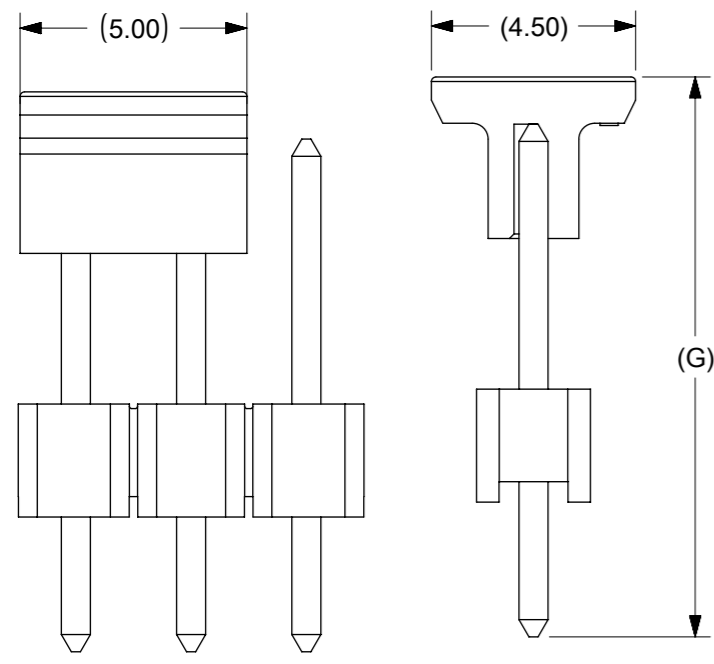

FUNCTIONAL SYMBOLS	THIS DRAWING CONTAINS INFORMATION THAT IS PROPRIETARY TO MOLEX ELECTRONIC TECHNOLOGIES, LLC AND SHOULD NOT BE USED WITHOUT WRITTEN PERMISSION		CURRENT REV DESC:				
	$\frac{F}{A} = 0$ $\frac{F}{E} = 0$ $\frac{F}{P} = 0$	DIMENSION UNITS mm					
DIVISIONAL SYMBOLS	GENERAL TOLERANCES (UNLESS SPECIFIED)		EC NO: 741471		CUSTOMER		
			DRWN: SUAIFR		2.54MM PITCH, SINGLE ROW SINGLE WAFER, T/H HEADER		
			CHK'D: SUAIFR		PRODUCT CUSTOMER DRAWING		
			APPR: MRAMAKRISHNA		DOCUMENT NUMBER		
			INITIAL REVISION:		DOC TYPE		
		DRWN: KCHO		DOC PART			
		APPR: SLOW		REVISION			
		ANGULAR TOL ± 3.0°		SD-87891-001			
DRAFT WHERE APPLICABLE MUST REMAIN WITHIN DIMENSIONS		THIRD ANGLE PROJECTION		MATERIAL NUMBER		CUSTOMER	
				SEE TABLE		GENERAL MARKET	
		DRAWING		SERIES		SHEET NUMBER	
		A3-SIZE		87891		2 OF 5	

10 9 8 7 6 5 4 3 2 1

CKT SIZE	DIMENSION		ASSY W/CAP IN T&R	ASSY W/O CAP IN T&R	ASSY W/O CAP IN TUBE	ASSY W/CAP IN TUBE	PART NO. W/O CAP IN TRAY PACKAGING	PART NO. IN BULK PACKAGING	CKT SIZE	VOID PIN	KINK PIN	(G)	DIMENSION			PLATING TYPE	CAP OPTION	REMARKS
	A	B											OAL	MATING END	SOLDIER TAIL			
01	2.54	---	-	-	-	-	87891-0108	-	01	-	-	-	10.80	5.08	3.23	5	-	-
02	5.08	2.54	-	-	-	-	87891-1017	-	01	-	-	-	12.29	6.80	3.00	3	-	-
03	7.62	5.08	-	-	-	-	87891-0200	-	02	-	-	-	11.76	6.09	3.18	5	-	-
04	10.16	7.62	-	-	-	-	87891-0205	-	02	-	-	-	11.30	5.84	2.97	4	-	-
05	12.70	10.16	-	-	-	-	87891-0206	-	02	-	-	-	11.30	5.84	2.97	5	-	-
06	15.24	12.70	-	-	-	-	87891-0211	-	02	-	-	-	11.30	5.84	2.97	5	-	-
07	17.78	15.24	-	-	-	-	87891-0207	-	02	-	-	-	9.80	4.00	3.31	5	-	-
08	20.32	17.78	-	-	-	-	87891-0208	-	02	-	-	-	7.49	4.00	1.00	2	-	-
09	22.86	20.32	-	-	-	-	87891-0209	-	02	-	-	-	10.80	5.08	3.23	5	-	-
10	25.40	22.86	-	-	-	-	87891-0210	-	02	-	-	-	31.00	25.54	2.97	5	-	-
11	27.94	25.40	-	-	-	-	87891-0216	-	02	-	-	-	7.29	2.40	2.40	5	-	-
12	30.48	27.94	-	-	-	-	87891-0212	-	02	-	-	-	18.37	12.68	3.20	5	-	-
13	33.02	30.48	-	-	-	-	87891-0211	-	02	-	-	-	26.49	20.80	3.20	5	-	-
14	35.56	33.02	-	-	-	-	87891-0214	-	02	-	-	-	19.49	13.00	4.00	5	-	-
15	38.10	35.56	-	-	-	-	87891-0215	-	02	-	-	14.98	13.98	7.49	4.00	5	A	-
16	40.64	38.10	-	-	-	-	87891-0213	-	02	-	-	-	12.14	5.84	3.81	4	-	-
17	43.18	40.64	-	-	-	-	87891-0306	-	03	-	-	-	11.30	5.84	2.97	5	-	-
18	45.72	43.18	-	-	-	-	87891-0308	-	03	-	-	-	11.30	5.84	2.97	5	-	-
19	48.26	45.72	-	-	-	-	87891-0307	-	03	-	-	-	22.73	18.74	1.50	5	-	-
20	50.80	48.26	-	-	-	-	87891-0003	-	03	2	-	-	13.72	9.65	1.78	6	-	-
21	53.34	50.80	-	-	-	-	87891-0312	-	03	-	-	-	11.30	5.84	2.97	4	-	-
22	55.88	53.34	-	-	-	-	87891-0311	-	03	-	-	12.34	11.30	5.84	2.97	5	B	REFER RPK-87891-0311 (FOR 87891-0311)
23	58.42	55.88	-	-	-	-	87891-0313	-	03	-	-	12.34	11.30	5.84	2.97	5	B	-
24	60.96	58.42	-	-	-	-	-	87891-0310	03	-	-	-	6.49	2.00	2.00	5	-	-
25	63.50	60.96	-	-	-	-	87891-0317	-	03	-	-	-	12.14	5.84	3.81	4	-	-
26	66.04	63.50	-	-	-	-	87891-0402	-	04	2	-	-	10.80	5.89	2.41	5	-	-
27	68.58	66.04	-	-	-	-	87891-0004	-	04	-	-	-	35.10	29.71	3.10	6	-	-
28	71.12	68.58	-	-	-	-	87891-0411	-	04	-	-	-	10.09	4.00	3.60	5	-	-
29	73.66	71.12	-	-	-	-	87891-0407	-	04	-	-	-	9.80	4.00	3.31	5	-	-
30	76.20	73.66	-	-	-	-	87891-0408	-	04	-	-	-	31.00	25.54	2.97	5	-	-
31	78.74	76.20	-	-	-	-	87891-0418	-	04	-	-	-	12.14	6.75	2.90	5	-	REFER 878910418-RPK (FOR 87891-0418)
32	81.28	78.74	-	-	-	-	87891-0409	-	04	-	-	-	12.14	6.75	2.90	4	-	-
33	83.82	81.28	-	-	-	-	87891-0417	-	04	-	-	16.31	15.11	9.01	3.61	5	A	-
34	86.36	83.82	-	-	-	-	87891-0432	-	04	-	-	-	18.03	13.54	2.00	5	-	-
35	88.90	86.36	-	-	-	-	87891-0430	-	04	-	-	-	13.09	8.00	2.80	5	A	-
36	91.44	88.90	-	-	-	-	-	-	-	-	-	-	-	-	-	-	-	-
37	93.98	91.44	-	-	-	-	-	-	-	-	-	-	-	-	-	-	-	-
38	96.52	93.98	-	-	-	-	-	-	-	-	-	-	-	-	-	-	-	-
39	99.06	96.52	-	-	-	-	-	-	-	-	-	-	-	-	-	-	-	-
40	101.60	99.06	-	-	-	-	-	-	-	-	-	-	-	-	-	-	-	-

FUNCTIONAL SYMBOLS		THIS DRAWING CONTAINS INFORMATION THAT IS PROPRIETARY TO MOLEX ELECTRONIC TECHNOLOGIES, LLC AND SHOULD NOT BE USED WITHOUT WRITTEN PERMISSION		CURRENT REV DESC:		molex	
$\nabla_A = 0$	mm	SCALE	NTS	EC NO: 741471			
$\nabla_F = 0$	GENERAL TOLERANCES (UNLESS SPECIFIED)		DRWN: SUAIFR		2023/03/07	CUSTOM HEADER	
$\nabla_P = 0$	MM INCH		CHK'D: SUAIFR		2023/03/08	2.54MM PITCH, SINGLE ROW SINGLE WAFER, T/H HEADER	
DIVISIONAL SYMBOLS	4 PLACES ±	±	APPR: MRAMAKRISHNA		2023/03/09	PRODUCT CUSTOMER DRAWING	
	3 PLACES ±	±	INITIAL REVISION:		DOCUMENT NUMBER		
	2 PLACES ±	0.2 ±	DRWN: KCHO		2004/03/24	SD-87891-001	
	1 PLACE ±	±	APPR: SLOW		2004/04/08	PSD	000
	0 PLACES ±	±	ANGULAR TOL ± 3.0°		D19		
DRAFT WHERE APPLICABLE MUST REMAIN WITHIN DIMENSIONS		THIRD ANGLE PROJECTION		DRAWING	SERIES	MATERIAL NUMBER	CUSTOMER
				A3-SIZE	87891	SEE TABLE	GENERAL MARKET
DOCUMENT STATUS		P1	RELEASE DATE	2023/03/09	04:23:59	SHEET NUMBER	
						3 OF 5	

9 8 7 6 5 4 3 2 1

F	ASSY W/CAP IN T&R	ASSY W/O CAP IN T&R	ASSY W/O CAP IN TUBE	ASSY W/CAP IN TUBE	PART NO. W/O CAP IN TRAY PACKAGING	PART NO. IN BULK PACKAGING	CKT SIZE	VOID PIN	KINK PIN	(G)			PLATING TYPE	CAP OPTION	REMARKS	
											OAL	MATING END				
											(F)	M				
-	-	-	-	-	87891-0500	-	05	-	-	-	11.94	6.10	3.30	5	-	-
-	-	-	-	-	87891-0505	-	05	-	-	-	11.94	6.10	3.30	5	-	-
-	-	-	-	-	87891-0501	-	05	-	-	-	13.62	8.08	3.05	5	-	-
-	-	-	-	-	87891-0502	-	05	2	-	-	10.80	5.89	2.41	5	-	-
-	-	-	-	-	87891-0503	-	05	2	-	-	45.00	13.51	29.00	5	-	-
-	-	-	-	-	87891-0504	-	05	2	-	-	45.00	13.51	29.00	3	-	-
-	-	-	-	-	87891-0507	-	05	4	-	-	10.92	5.84	2.59	3	-	-
-	-	-	-	-	-	87891-0508	05	2,4	-	-	11.38	5.84	3.05	5	-	-
-	-	-	-	-	87891-0522	-	05	2&4	-	-	19.49	13.00	4.00	5	-	-
-	-	-	-	-	87891-0516	-	05	-	-	-	32.49	16.00	14.00	4	-	-
-	-	-	-	-	87891-0517	-	05	-	-	-	23.62	17.32	3.81	5	-	-
-	-	-	-	-	87891-0523	-	05	-	-	-	7.29	2.40	2.40	5	-	-
-	87891-0521	-	-	-	-	-	05	-	-	10.10	9.89	2.80	4.60	5	A	-
-	-	-	-	-	87891-0601	-	06	-	-	-	11.30	5.84	2.97	1	-	-
-	-	-	-	-	87891-0602	-	06	-	-	-	12.80	8.00	2.31	5	-	-
-	-	-	-	-	87891-0606	-	06	-	-	-	11.30	5.84	2.97	5	-	-
-	-	-	-	-	87891-0610	-	06	-	-	-	11.30	5.84	2.97	5	-	-
-	-	-	-	-	87891-0607	-	06	-	-	-	13.75	8.08	3.18	5	-	-
-	-	-	-	-	87891-0608	-	06	-	-	-	18.03	13.54	2.00	5	-	-
-	-	-	-	-	87891-0609	-	06	-	-	-	28.30	22.16	3.65	5	-	-
-	-	-	-	-	87891-0611	-	06	-	-	-	28.30	22.16	3.65	5	-	-
87891-0613	-	-	-	-	-	-	06	-	-	22.99	21.99	16.00	3.50	5	A	-
-	-	-	-	-	87891-0615	-	06	-	-	-	14.49	10.00	2.00	1	-	-
-	-	-	-	-	87891-0624	-	06	-	-	-	26.10	19.81	3.80	5	-	-
-	-	-	-	-	87891-0700	-	07	-	-	-	11.94	6.10	3.30	5	-	-
-	-	-	-	-	87891-0702	-	07	-	-	-	11.94	6.10	3.30	5	-	-
-	-	-	-	-	87891-0751	-	07	-	-	-	13.74	8.00	3.25	5	-	-
87891-0007	-	-	-	-	-	-	07	-	-	-	13.72	9.65	1.78	6	-	-
-	-	-	-	-	87891-0851	-	08	-	-	-	13.74	8.00	3.25	5	-	-
87891-0807	-	-	-	-	-	-	08	-	-	13.59	12.59	7.90	2.20	5	A	-
-	-	-	-	-	87891-0808	-	08	-	-	-	20.53	13.72	4.32	3	-	-
-	-	-	-	-	87891-0809	-	08	-	-	-	11.30	5.84	2.97	5	-	-

<p>FUNCTIONAL SYMBOLS</p> <p>$\nabla_A = 0$</p> <p>$\nabla_F = 0$</p> <p>$\nabla_P = 0$</p> <p>DIVISIONAL SYMBOLS</p>										<p>THIS DRAWING CONTAINS INFORMATION THAT IS PROPRIETARY TO MOLEX ELECTRONIC TECHNOLOGIES, LLC AND SHOULD NOT BE USED WITHOUT WRITTEN PERMISSION</p> <p>SCALE: mm NTS</p> <p>GENERAL TOLERANCES (UNLESS SPECIFIED)</p> <table border="1"> <tr><th colspan="2">MM</th><th colspan="2">INCH</th></tr> <tr><td>4 PLACES</td><td>±</td><td></td><td>±</td></tr> <tr><td>3 PLACES</td><td>±</td><td></td><td>±</td></tr> <tr><td>2 PLACES</td><td>±</td><td>0.2</td><td>±</td></tr> <tr><td>1 PLACE</td><td>±</td><td></td><td>±</td></tr> <tr><td>0 PLACES</td><td>±</td><td></td><td>±</td></tr> </table> <p>ANGULAR TOL ± 3.0°</p> <p>DRAFT WHERE APPLICABLE MUST REMAIN WITHIN DIMENSIONS</p>										MM		INCH		4 PLACES	±		±	3 PLACES	±		±	2 PLACES	±	0.2	±	1 PLACE	±		±	0 PLACES	±		±	<p>CURRENT REV DESC:</p> <p>EC NO: 741471</p> <p>DRWN: SUAIFR</p> <p>CHK'D: SUAIFR</p> <p>APPR: MRAMAKRISHNA</p> <p>INITIAL REVISION:</p> <p>DRWN: KCHO</p> <p>APPR: SCLOW</p>										<p>molex</p> <p>CUSTOM HEADER</p> <p>2.54MM PITCH, SINGLE ROW SINGLE WAFER, T/H HEADER</p> <p>PRODUCT CUSTOMER DRAWING</p> <p>DOCUMENT NUMBER: SD-87891-001</p> <p>DOC TYPE: PSD</p> <p>DOC PART: 000</p> <p>REVISION: D19</p> <p>MATERIAL NUMBER: SEE TABLE</p> <p>CUSTOMER: GENERAL MARKET</p> <p>SHEET NUMBER: 4 OF 5</p>									
MM		INCH																																																													
4 PLACES	±		±																																																												
3 PLACES	±		±																																																												
2 PLACES	±	0.2	±																																																												
1 PLACE	±		±																																																												
0 PLACES	±		±																																																												

FORMAT: Mel-lega-master-ib-prod-A3
REVISION: E
DATE: 2023/01/14

ASSY W/CAP IN T&R	ASSY W/O CAP IN T&R	ASSY W/O CAP IN TUBE	ASSY W/CAP IN TUBE	PART NO. W/O CAP IN TRAY PACKAGING	PART NO. IN BULK PACKAGING	CKT SIZE	VOID PIN	KINK PIN	(G)		PLATING TYPE	CAP OPTION	REMARKS		
									(F)	M					
-	-	-	-	-	87891-2601	26	4,7,17	-	-	11.13	5.59	3.05	3	-	-
87891-1817	-	-	-	-	-	18	-	-	18.36	17.20	13.21	1.50	5	A	-
87891-1819	-	-	-	-	-	18	-	-	18.36	17.20	13.21	1.50	5	A	-
87891-1818	-	-	-	-	-	18	-	-	18.36	17.20	13.21	1.50	3	A	-
-	-	-	-	87891-2007	-	20	-	-	-	21.49	9.50	9.50	1	-	-
87891-2817	-	-	-	-	-	28	-	-	18.36	17.20	13.21	1.50	5	A	-
87891-2819	-	-	-	-	-	28	-	-	18.36	17.20	13.21	1.50	5	A	-
87891-2818	-	-	-	-	-	28	-	-	18.36	17.20	13.21	1.50	3	A	-
-	-	-	-	-	87891-3007	30	-	-	-	11.30	5.84	2.97	5	-	-
-	-	-	-	-	87891-3600	36	-	-	-	11.56	6.09	3.18	2	-	-
-	-	-	-	-	87891-4008	40	-	-	-	11.30	5.84	2.97	5	-	-
-	-	87891-4007	-	-	-	40	-	-	-	12.14	5.84	3.81	3	-	-

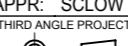
FUNCTIONAL SYMBOLS	THIS DRAWING CONTAINS INFORMATION THAT IS PROPRIETARY TO MOLEX ELECTRONIC TECHNOLOGIES, LLC AND SHOULD NOT BE USED WITHOUT WRITTEN PERMISSION											
	$\nabla_A = 0$ $\nabla_F = 0$ $\nabla_P = 0$	DIMENSION UNITS mm	SCALE NTS	CURRENT REV DESC:								
DIVISIONAL SYMBOLS	GENERAL TOLERANCES (UNLESS SPECIFIED)		EC NO: 741471		DRWN: SUAIFR		2023/03/07		CHK'D: SUAIFR		2023/03/08	
	MM		INCH		APPR: MRAMAKRISHNA		2023/03/09		INITIAL REVISION:		DOCUMENT NUMBER	
	4 PLACES	±		±	DRWN: KCHO		2004/03/24		APPR: SLOW		2004/04/08	
	3 PLACES	±		±	MATERIAL NUMBER		CUSTOMER		SHEET NUMBER			
	2 PLACES	±	0.2	±	SD-87891-001		GENERAL MARKET		5 OF 5			
	1 PLACE	±		±	SEE TABLE							
	0 PLACES	±		±								
	ANGULAR TOL		± 3.0°		THIRD ANGLE PROJECTION		DRAWING		SERIES			
	DRAFT WHERE APPLICABLE MUST REMAIN WITHIN DIMENSIONS						A3-SIZE		87891			

DOCUMENT STATUS	P1	RELEASE DATE	2023/03/09	04:23:59
-----------------	----	--------------	------------	----------