

LM4951 Boomer® Audio Power Amplifier Series **Wide Voltage Range 1.8 Watt Audio Amplifier**

Check for Samples: [LM4951](#)

FEATURES

- **Click and Pop Circuitry Eliminates Noise during Turn-On and Turn-Off Transitions**
- **Low Current, Active-Low Shutdown Mode**
- **Low Quiescent Current**
- **Thermal Shutdown Protection**
- **Unity-Gain Stable**
- **External Gain Configuration Capability**

APPLICATIONS

- **Portable Handheld Devices up to 9V**
- **Cell Phone**
- **PDA**

KEY SPECIFICATIONS

- **Wide Voltage Range: 2.7V to 9 V**
- **Quiescent Power Supply Current ($V_{DD} = 7.5V$): 2.5mA (typ)**
- **Power Output BTL at 7.5V, 1% THD: 1.8 W (typ)**
- **Shutdown Current: 0.01 μ A (typ)**
- **Fast Turn on Time: 25ms (typ)**

DESCRIPTION

The LM4951 is an audio power amplifier primarily designed for demanding applications in Portable Handheld devices. It is capable of delivering 1.8W mono BTL to an 8 Ω load, continuous average power, with less than 1% distortion (THD+N) from a 7.5V_{DC} power supply.

Boomer audio power amplifiers were designed specifically to provide high quality output power with a minimal amount of external components. The LM4951 does not require bootstrap capacitors, or snubber circuits.

The LM4951 features a low-power consumption active-low shutdown mode. Additionally, the LM4951 features an internal thermal shutdown protection mechanism.

The LM4951 contains advanced click and pop circuitry that eliminates noises which would otherwise occur during turn-on and turn-off transitions.

The LM4951 is unity-gain stable and can be configured by external gain-setting resistors.



Please be aware that an important notice concerning availability, standard warranty, and use in critical applications of Texas Instruments semiconductor products and disclaimers thereto appears at the end of this data sheet.

All trademarks are the property of their respective owners.

Typical Application

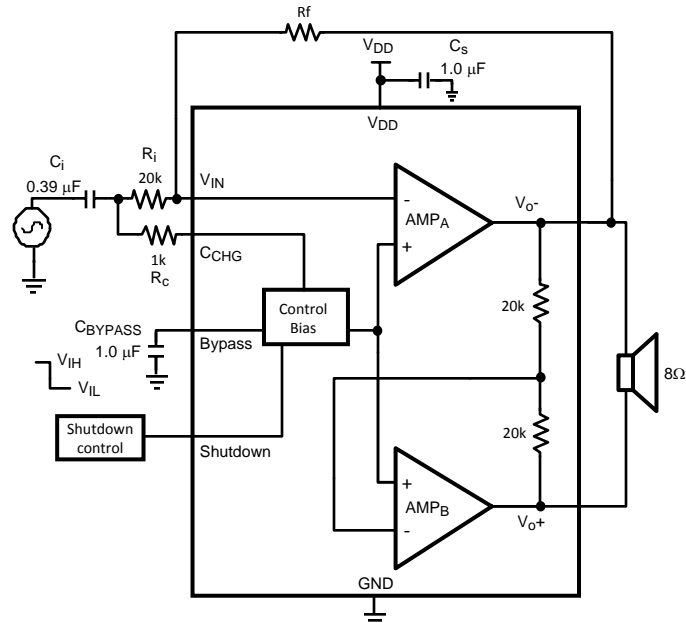

* R_C is needed for over/under voltage protection. If inputs are less than $V_{DD} + 0.3V$ and greater than $-0.3V$, and if inputs are disabled when in shutdown mode, then R_C may be shorted.

Figure 1. Typical Bridge-Tied-Load (BTL) Audio Amplifier Application Circuit

Connection Diagram

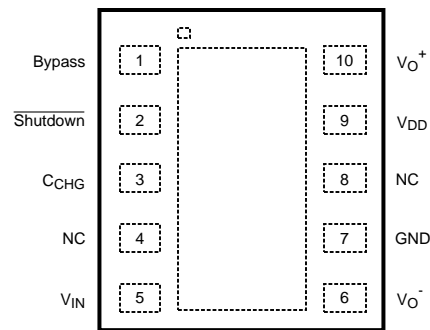
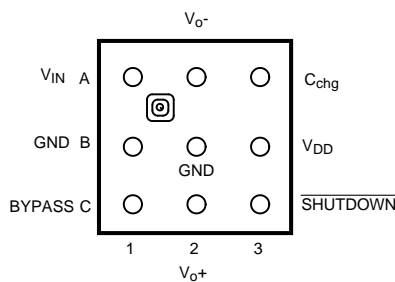

Figure 2. DPR Package (Top View)
See Package Number DPR0010A



A. * DAP can either be soldered to GND or left floating.

Figure 3. 9 Bump DSBGA Package (Top View)
See Package Number YZR0009AAA



These devices have limited built-in ESD protection. The leads should be shorted together or the device placed in conductive foam during storage or handling to prevent electrostatic damage to the MOS gates.

Absolute Maximum Ratings⁽¹⁾⁽²⁾⁽³⁾

Supply Voltage	9.5V
Storage Temperature	-65°C to +150°C
Input Voltage	-0.3V to $V_{DD} + 0.3V$
Power Dissipation ⁽⁴⁾	Internally limited
ESD Susceptibility ⁽⁵⁾	2000V
ESD Susceptibility ⁽⁶⁾	200V
Junction Temperature	150°C
Thermal Resistance θ_{JA} (WSON) ⁽⁴⁾	52°C/W
See AN-1187 'Leadless Leadframe Packaging (WSON)' (Literature Number SNOA401)	

- (1) All voltages are measured with respect to the GND pin, unless otherwise specified.
- (2) Absolute Maximum Ratings indicate limits beyond which damage to the device may occur. Operating Ratings indicate conditions for which the device is functional, but do not ensure specific performance limits. Electrical Characteristics state DC and AC electrical specifications under particular test conditions which ensure specific performance limits. This assumes that the device is within the Operating Ratings. Specifications are not specified for parameters where no limit is given, however, the typical value is a good indication of device performance.
- (3) If Military/Aerospace specified devices are required, please contact the Texas Instruments Sales Office/ Distributors for availability and specifications.
- (4) The maximum power dissipation must be derated at elevated temperatures and is dictated by T_{JMAX} , θ_{JA} , and the ambient temperature, T_A . The maximum allowable power dissipation is $P_{DMAX} = (T_{JMAX} - T_A) / \theta_{JA}$ or the given in Absolute Maximum Ratings, whichever is lower. For the LM4951 typical application (shown in [Figure 1](#)) with $V_{DD} = 7.5V$, $R_L = 8\Omega$ mono-BTL operation the max power dissipation is 1.42W. $\theta_{JA} = 73^\circ C/W$.
- (5) Human body model, 100pF discharged through a 1.5k Ω resistor.
- (6) Machine Model, 220pF–240pF discharged through all pins.

Operating Ratings

Temperature Range	$T_{MIN} \leq T_A \leq T_{MAX}$	$-40^\circ C \leq T_A \leq +85^\circ C$
Supply Voltage		$2.7V \leq V_{DD} \leq 9V$

Electrical Characteristics $V_{DD} = 7.5V^{(1)(2)}$

The following specifications apply for $V_{DD} = 7.5V$, $A_{V-BTL} = 6dB$, $R_L = 8\Omega$ unless otherwise specified. Limits apply for $T_A = 25^\circ C$.

Symbol	Parameter	Conditions	LM4951		Units (Limits)
			Typical ⁽³⁾	Limit ⁽⁴⁾⁽⁵⁾	
I_{DD}	Quiescent Power Supply Current	$V_{IN} = 0V$, $I_O = 0A$, $R_L = 8\Omega$	2.5	4.5	mA (max)
I_{SD}	Shutdown Current	$V_{SHUTDOWN} = GND^{(6)}$	0.01	5	μA (max)
V_{OS}	Offset Voltage		5	30	mV (max)
V_{SDIH}	Shutdown Voltage Input High			1.2	V (min)
V_{SDIL}	Shutdown Voltage Input Low			0.4	V (max)
$R_{pulldown}$	Pulldown Resistor on S/D		75	45	k Ω (min)
T_{WU}	Wake-up Time	$C_B = 1.0\mu F$	25	35	ms
T_{sd}	Shutdown time	$C_B = 1.0\mu F$		10	ms (max)
T_{SD}	Thermal Shutdown Temperature		170	150 190	$^\circ C$ (min) $^\circ C$ (max)
P_O	Output Power	THD = 1% (max); $f = 1kHz$ $R_L = 8\Omega$ Mono BTL	1.8	1.5	W (min)
THD+N	Total Harmonic Distortion + Noise	$P_O = 600mWrms$; $f = 1kHz$ $A_{V-BTL} = 6dB$	0.07	0.5	% (max)
THD+N	Total Harmonic Distortion + Noise	$P_O = 600mWrms$; $f = 1kHz$ $A_{V-BTL} = 26dB$	0.35		%
ϵ_{OS}	Output Noise	A-Weighted Filter, $R_i = R_f = 20k\Omega$ Input Referred, Note 10	10		μV
PSRR	Power Supply Rejection Ratio	$V_{RIPPLE} = 200mV_{p-p}$, $f = 217Hz$, $C_B = 1.0\mu F$, Input Referred	66	56	dB (min)

- (1) All voltages are measured with respect to the GND pin, unless otherwise specified.
- (2) Absolute Maximum Ratings indicate limits beyond which damage to the device may occur. Operating Ratings indicate conditions for which the device is functional, but do not ensure specific performance limits. Electrical Characteristics state DC and AC electrical specifications under particular test conditions which ensure specific performance limits. This assumes that the device is within the Operating Ratings. Specifications are not specified for parameters where no limit is given, however, the typical value is a good indication of device performance.
- (3) Typical values are measured at $25^\circ C$ and represent the parametric norm.
- (4) Limits are specified to AOQL (Average Outgoing Quality Level).
- (5) Datasheet min/max specification limits are specified by design, test, or statistical analysis.
- (6) Shutdown current is measured in a normal room environment. The Shutdown pin should be driven as close as possible to GND for minimum shutdown current.

Electrical Characteristics $V_{DD} = 3.3V^{(1)(2)}$

The following specifications apply for $V_{DD} = 3.3V$, $A_{V-BTL} = 6dB$, $R_L = 8\Omega$ unless otherwise specified. Limits apply for $T_A = 25^\circ C$.

Symbol	Parameter	Conditions	LM4951		Units (Limits)
			Typical ⁽³⁾	Limit ⁽⁴⁾⁽⁵⁾	
I_{DD}	Quiescent Power Supply Current	$V_{IN} = 0V$, $I_O = 0A$, $R_L = 8\Omega$	2.5	4.5	mA (max)
I_{SD}	Shutdown Current	$V_{SHUTDOWN} = GND^{(6)}$	0.01	2	μA (max)
V_{OS}	Offset Voltage		3	30	mV (max)
V_{SDIH}	Shutdown Voltage Input High			1.2	V (min)
V_{SDIL}	Shutdown Voltage Input Low			0.4	V (max)
T_{WU}	Wake-up Time	$C_B = 1.0\mu F$	25		ms (max)
T_{sd}	Shutdown time	$C_B = 1.0\mu F$		10	ms (max)
P_O	Output Power	THD = 1% (max); $f = 1kHz$ $R_L = 8\Omega$ Mono BTL	280	230	mW (min)
THD+N	Total Harmonic Distortion + Noise ¹	$P_O = 100mW_{rms}$; $f = 1kHz$ $A_{V-BTL} = 6dB$	0.07	0.5	% (max)
THD+N	Total Harmonic Distortion + Noise ¹	$P_O = 100mW_{rms}$; $f = 1kHz$ $A_{V-BTL} = 26dB$	0.35		%
ϵ_{OS}	Output Noise	A-Weighted Filter, $R_i = R_f = 20k\Omega$ Input Referred, Note 10	10		μV
PSRR	Power Supply Rejection Ratio	$V_{RIPPLE} = 200mV_{p-p}$, $f = 217Hz$, $C_B = 1\mu F$, Input Referred	71	61	dB (min)

- (1) All voltages are measured with respect to the GND pin, unless otherwise specified.
- (2) Absolute Maximum Ratings indicate limits beyond which damage to the device may occur. Operating Ratings indicate conditions for which the device is functional, but do not ensure specific performance limits. Electrical Characteristics state DC and AC electrical specifications under particular test conditions which ensure specific performance limits. This assumes that the device is within the Operating Ratings. Specifications are not specified for parameters where no limit is given, however, the typical value is a good indication of device performance.
- (3) Typical values are measured at $25^\circ C$ and represent the parametric norm.
- (4) Limits are specified to AOQL (Average Outgoing Quality Level).
- (5) Datasheet min/max specification limits are specified by design, test, or statistical analysis.
- (6) Shutdown current is measured in a normal room environment. The Shutdown pin should be driven as close as possible to GND for minimum shutdown current.

Typical Performance Characteristics

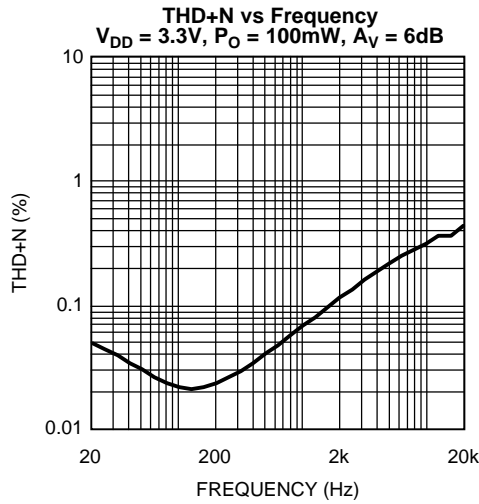

Figure 4.

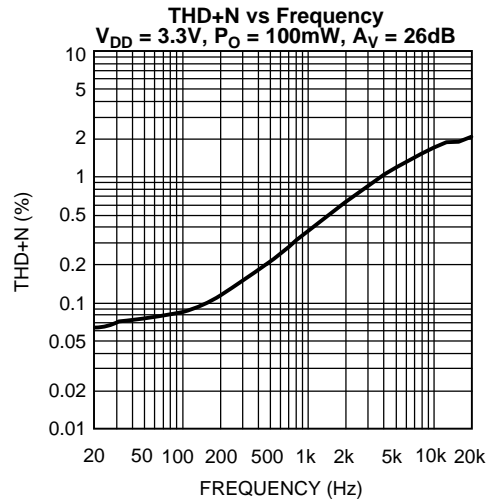

Figure 5.

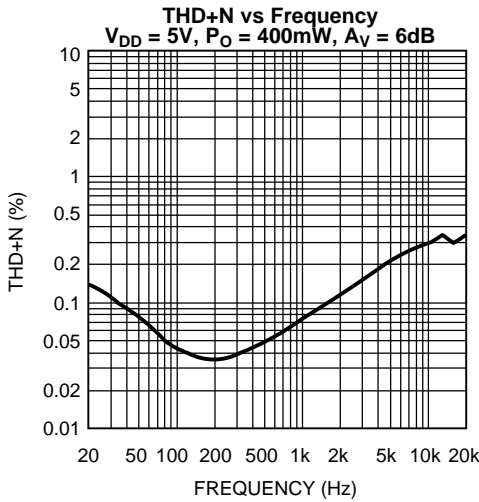

Figure 6.

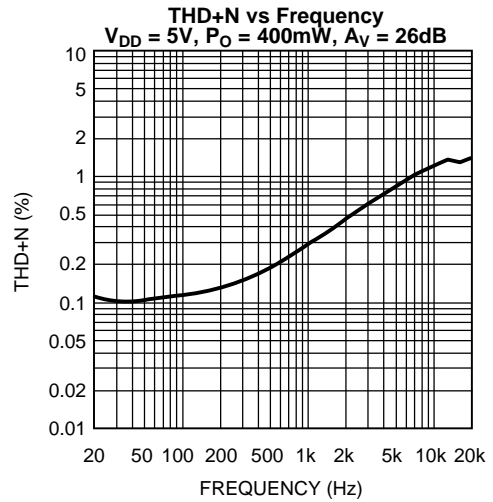

Figure 7.

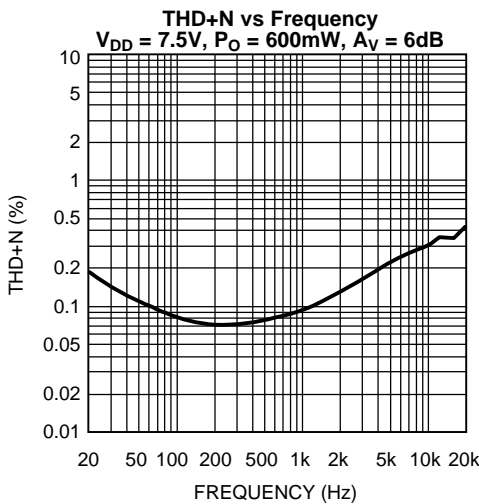

Figure 8.

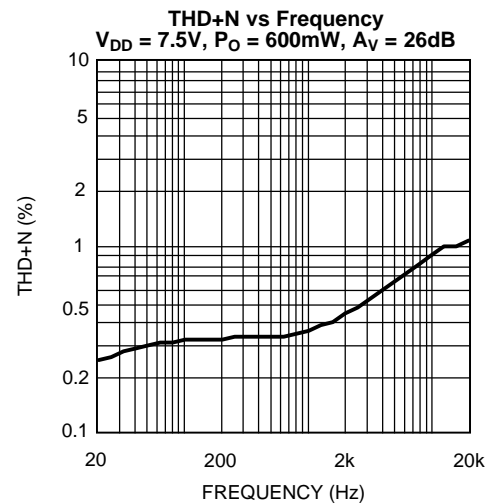

Figure 9.

Typical Performance Characteristics (continued)

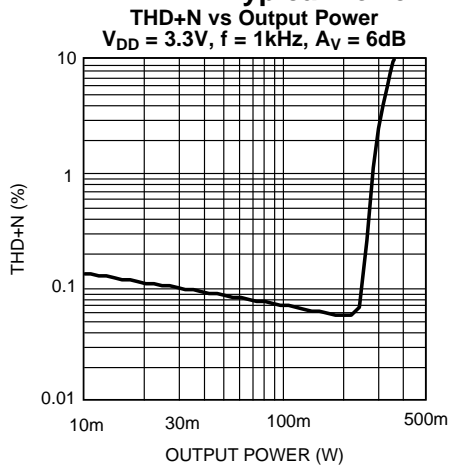

Figure 10.

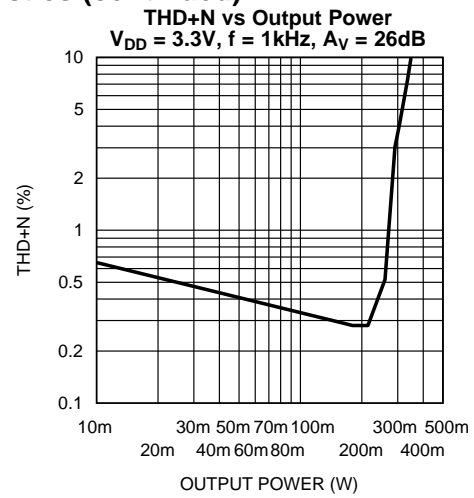

Figure 11.

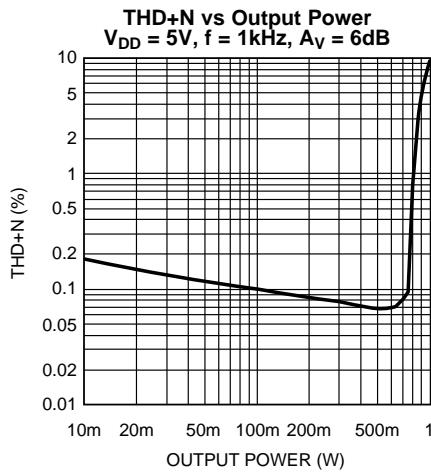

Figure 12.

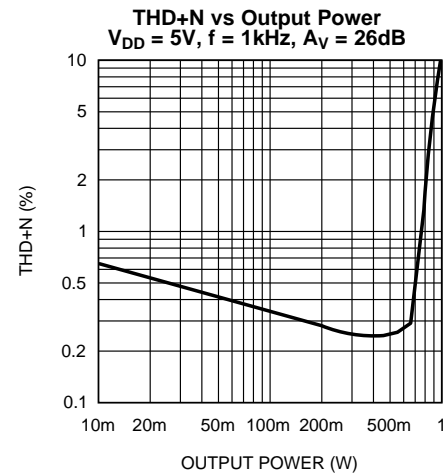

Figure 13.

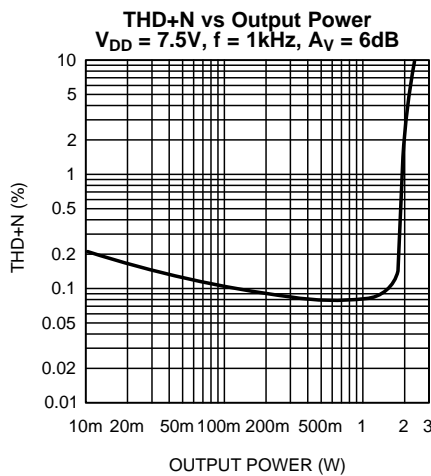

Figure 14.

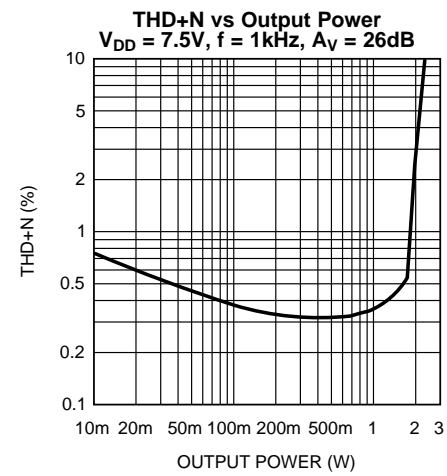

Figure 15.

Typical Performance Characteristics (continued)

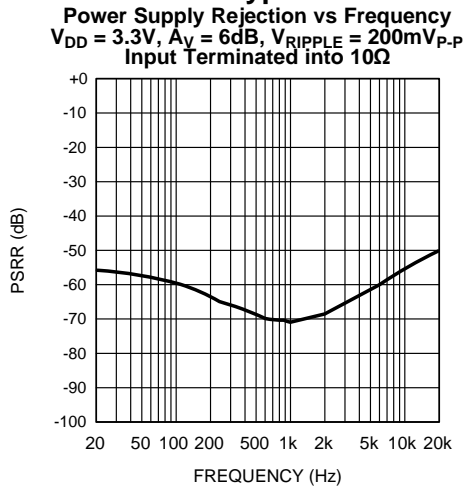

Figure 16.

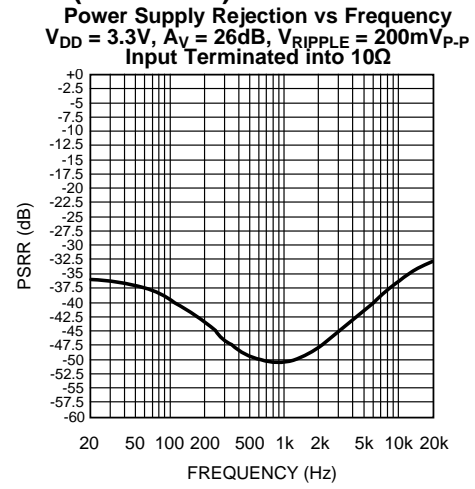

Figure 17.

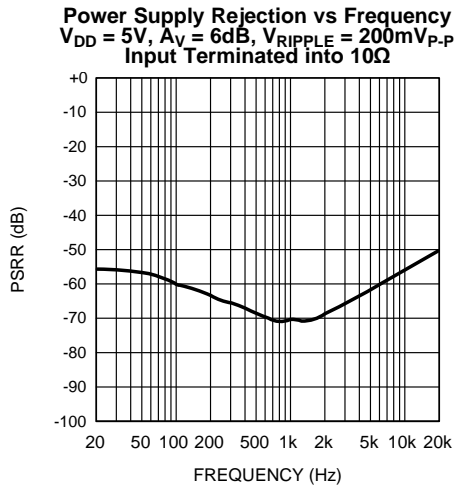

Figure 18.

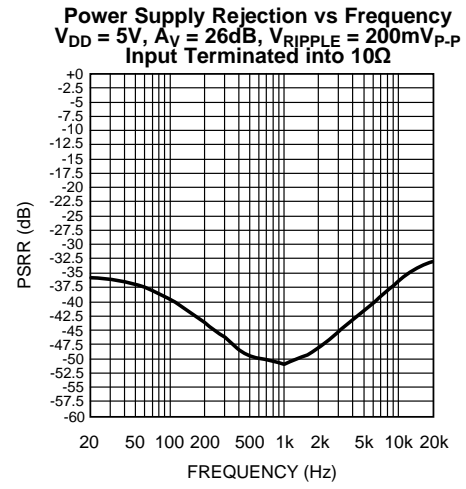

Figure 19.

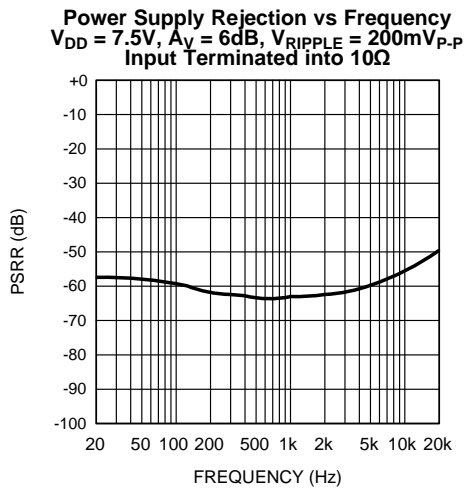

Figure 20.

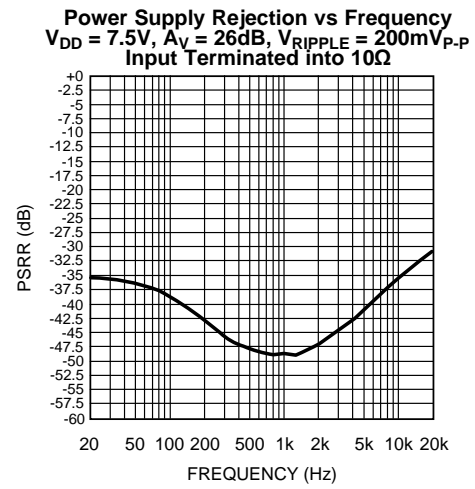

Figure 21.

Typical Performance Characteristics (continued)

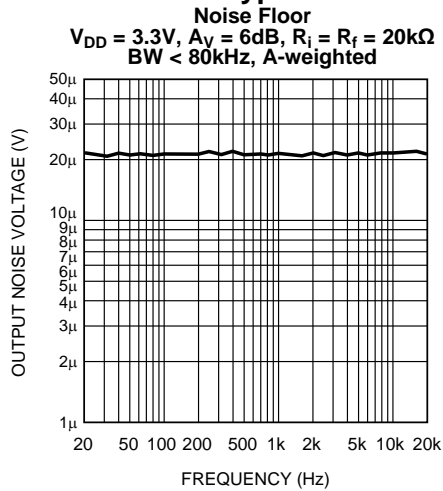

Figure 22.

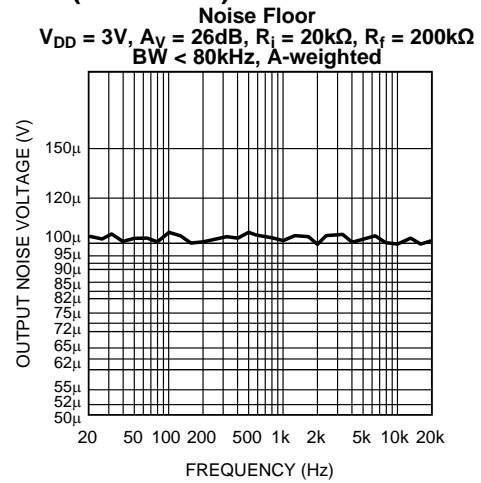

Figure 23.

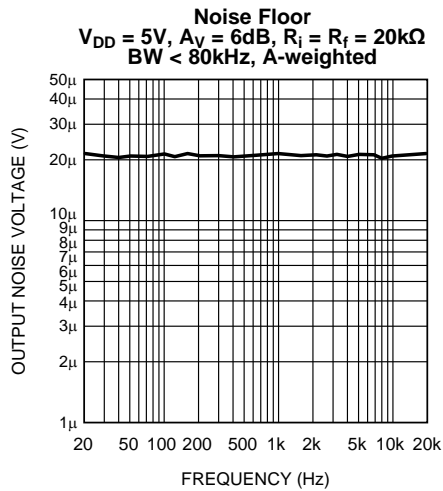

Figure 24.

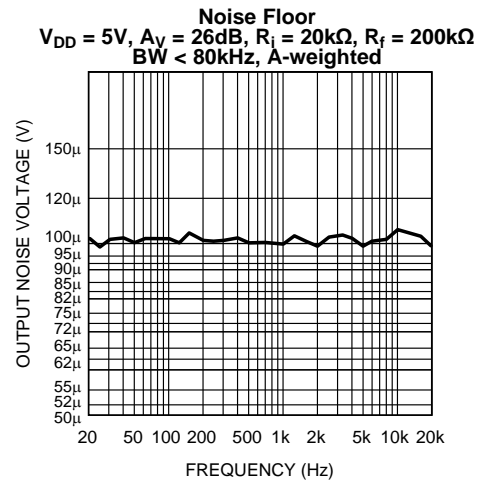

Figure 25.

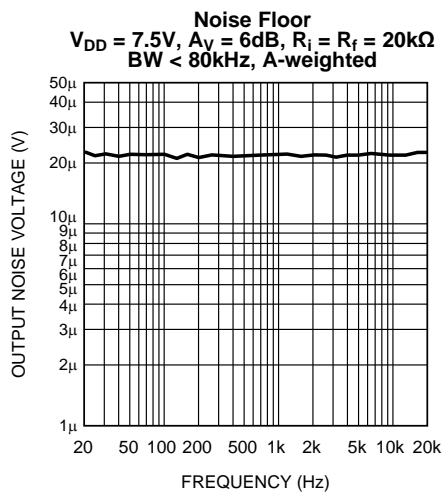

Figure 26.

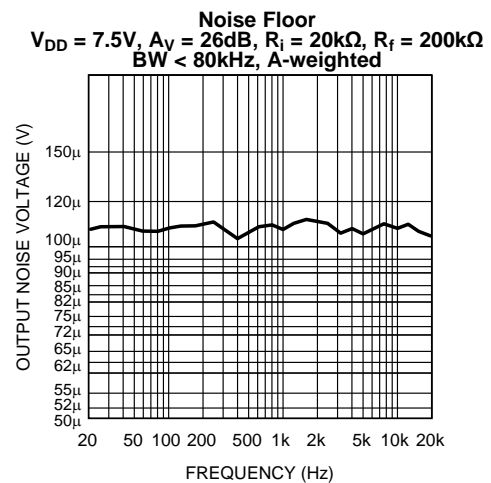

Figure 27.

Typical Performance Characteristics (continued)

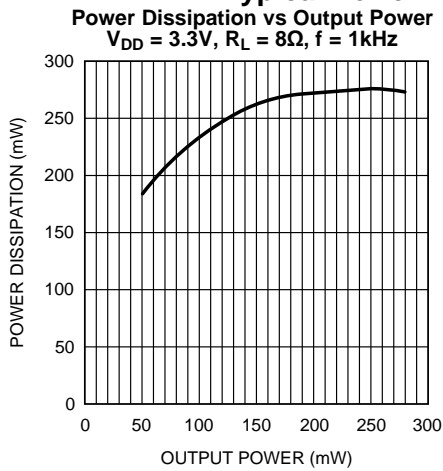

Figure 28.

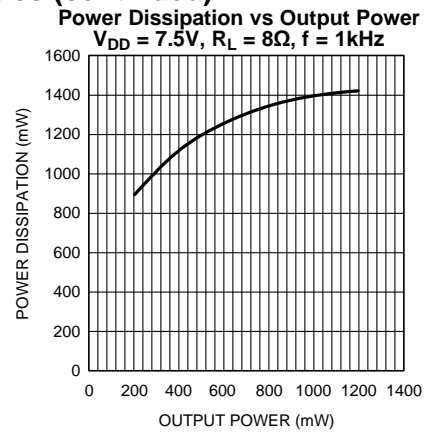

Figure .

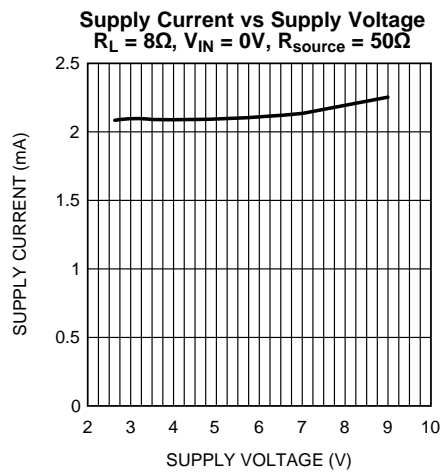

Figure 29.

Clipping Voltage vs Supply Voltage
 $R_L = 8\Omega,$
 from top to bottom: Negative Voltage Swing; Positive Voltage Swing

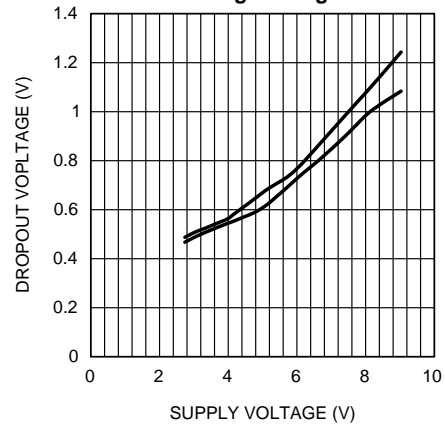

Figure 30.

Output Power vs Supply Voltage
 $R_L = 8\Omega,$
 from top to bottom: THD+N = 10%, THD+N = 1%

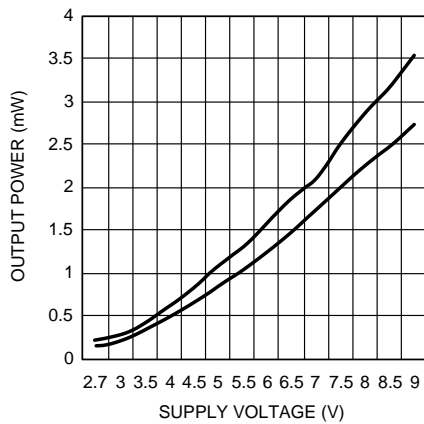

Figure 31.

Output Power vs Load Resistance
 $V_{DD} = 3.3V, f = 1kHz$
 from top to bottom: THD+N = 10%, THD+N = 1%

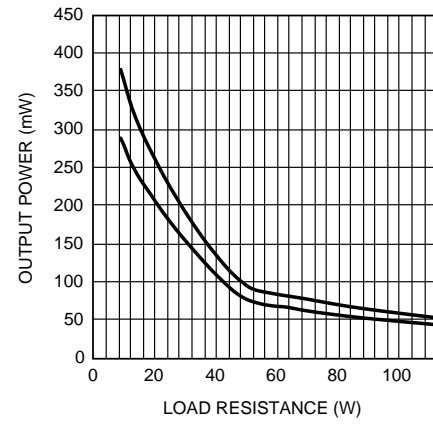

Figure 32.

Typical Performance Characteristics (continued)

Output Power vs Load Resistance
 $V_{DD} = 7.5V$, $f = 1kHz$
 from top to bottom: THD+N = 10%, THD+N = 1%

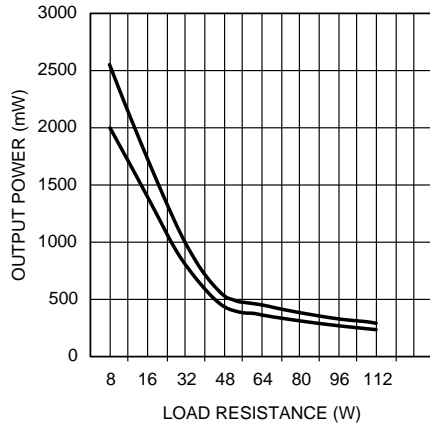

Figure 33.

Frequency Response vs Input Capacitor Size
 $R_L = 8\Omega$
 from top to bottom: $C_i = 1.0\mu F$, $C_i = 0.39\mu F$, $C_i = 0.039\mu F$

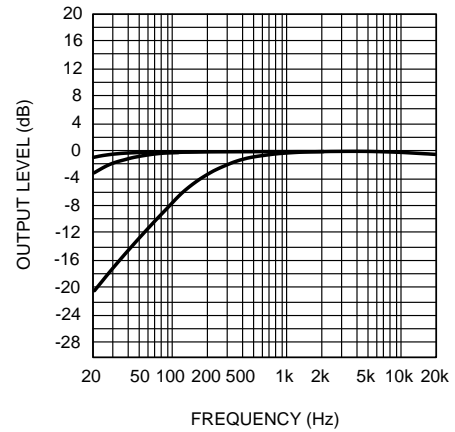

Figure 34.

APPLICATION INFORMATION

HIGH VOLTAGE BOOMER

Unlike previous 5V Boomer amplifiers, the LM4951 is designed to operate over a power supply voltages range of 2.7V to 9V. Operating on a 7.5V power supply, the LM4951 will deliver 1.8W into an 8Ω BTL load with no more than 1% THD+N.

BRIDGE CONFIGURATION EXPLANATION

As shown in [Figure 1](#), the LM4951 consists of two operational amplifiers that drive a speaker connected between their outputs. The value of input and feedback resistors determine the gain of each amplifier. External resistors R_i and R_f set the closed-loop gain of AMP_A, whereas two 20kΩ internal resistors set AMP_B's gain to -1. The LM4951 drives a load, such as a speaker, connected between the two amplifier outputs, V_{O+} and V_{O-} . [Figure 1](#) shows that AMP_A's output serves as AMP_B's input. This results in both amplifiers producing signals identical in magnitude, but 180° out of phase. Taking advantage of this phase difference, a load is placed between AMP_A and AMP_B and driven differentially (commonly referred to as "bridge mode"). This results in a differential, or BTL, gain of

$$A_{VD} = 2(R_f / R_i) \quad (1)$$

Bridge mode amplifiers are different from single-ended amplifiers that drive loads connected between a single amplifier's output and ground. For a given supply voltage, bridge mode has a distinct advantage over the single-ended configuration: its differential output doubles the voltage swing across the load. Theoretically, this produces four times the output power when compared to a single-ended amplifier under the same conditions. This increase in attainable output power assumes that the amplifier is not current limited and that the output signal is not clipped. To ensure minimum output signal clipping when choosing an amplifier's closed-loop gain, refer to the [AUDIO POWER AMPLIFIER DESIGN](#) section. Under rare conditions, with unique combinations of high power supply voltage and high closed loop gain settings, the LM4951 may exhibit low frequency oscillations.

Another advantage of the differential bridge output is no net DC voltage across the load. This is accomplished by biasing AMP1's and AMP2's outputs at half-supply. This eliminates the coupling capacitor that single supply, single-ended amplifiers require. Eliminating an output coupling capacitor in a typical single-ended configuration forces a single-supply amplifier's half-supply bias voltage across the load. This increases internal IC power dissipation and may permanently damage loads such as speakers.

POWER DISSIPATION

Power dissipation is a major concern when designing a successful bridged amplifier.

The LM4951's dissipation when driving a BTL load is given by [Equation \(2\)](#). For a 7.5V supply and a single 8Ω BTL load, the dissipation is 1.42W.

$$P_{\text{DMAX-MONOBTL}} = 4(V_{\text{DD}})^2 / 2\pi^2 R_L \quad \text{Bridge Mode} \quad (2)$$

The maximum power dissipation point given by [Equation \(2\)](#) must not exceed the power dissipation given by [Equation \(3\)](#):

$$P_{\text{DMAX}}' = (T_{\text{JMAX}} - T_A) / \theta_{\text{JA}} \quad (3)$$

The LM4951's $T_{\text{JMAX}} = 150^\circ\text{C}$. In the DPR package, the LM4951's θ_{JA} is 73°C/W when the metal tab is soldered to a copper plane of at least 1in^2 . This plane can be split between the top and bottom layers of a two-sided PCB. Connect the two layers together under the tab with an array of vias. At any given ambient temperature T_A , use [Equation \(3\)](#) to find the maximum internal power dissipation supported by the IC packaging. Rearranging [Equation \(3\)](#) and substituting P_{DMAX} for P_{DMAX}' results in [Equation \(4\)](#). This equation gives the maximum ambient temperature that still allows maximum stereo power dissipation without violating the LM4951's maximum junction temperature.

$$T_A = T_{\text{JMAX}} - P_{\text{DMAX-MONOBTL}} \theta_{\text{JA}} \quad (4)$$

For a typical application with a 7.5V power supply and a BTL 8Ω load, the maximum ambient temperature that allows maximum stereo power dissipation without exceeding the maximum junction temperature is approximately 46°C for the TS package.

$$T_{JMAX} = P_{DMAX-MONOBTL} \theta_{JA} + T_A \quad (5)$$

Equation (5) gives the maximum junction temperature T_{JMAX} . If the result violates the LM4951's 150°C, reduce the maximum junction temperature by reducing the power supply voltage or increasing the load resistance. Further allowance should be made for increased ambient temperatures.

The above examples assume that a device is operating around the maximum power dissipation point. Since internal power dissipation is a function of output power, higher ambient temperatures are allowed as output power or duty cycle decreases.

If the result of Equation 2 is greater than that of Equation (3), then decrease the supply voltage, increase the load impedance, or reduce the ambient temperature. Further, ensure that speakers rated at a nominal 8Ω do not fall below 6Ω. If these measures are insufficient, a heat sink can be added to reduce θ_{JA} . The heat sink can be created using additional copper area around the package, with connections to the ground pins, supply pin and amplifier output pins. Refer to the [Typical Performance Characteristics](#) curves for power dissipation information at lower output power levels.

POWER SUPPLY VOLTAGE LIMITS

Continuous proper operation is ensured by never exceeding the voltage applied to any pin, with respect to ground, as listed in the [Absolute Maximum Ratings](#) section.

POWER SUPPLY BYPASSING

As with any power amplifier, proper supply bypassing is critical for low noise performance and high power supply rejection. Applications that employ a voltage regulator typically use a 10μF in parallel with a 0.1μF filter capacitors to stabilize the regulator's output, reduce noise on the supply line, and improve the supply's transient response. However, their presence does not eliminate the need for a local 1.0μF tantalum bypass capacitance connected between the LM4951's supply pins and ground. Do not substitute a ceramic capacitor for the tantalum. Doing so may cause oscillation. Keep the length of leads and traces that connect capacitors between the LM4951's power supply pin and ground as short as possible. Connecting a larger capacitor, C_{BYPASS} , between the BYPASS pin and ground improves the internal bias voltage's stability and improves the amplifier's PSRR. The PSRR improvements increase as the bypass pin capacitor value increases. Too large, however, increases turn-on time and can compromise the amplifier's click and pop performance. The selection of bypass capacitor values, especially C_{BYPASS} , depends on desired PSRR requirements, click and pop performance (as explained in the section, [SELECTING EXTERNAL COMPONENTS](#)), system cost, and size constraints.

MICRO-POWER SHUTDOWN

The LM4951 features an active-low micro-power shutdown mode. When active, the LM4951's micro-power shutdown feature turns off the amplifier's bias circuitry, reducing the supply current. The low 0.01μA typical shutdown current is achieved by applying a voltage to the SHUTDOWN pin that is as near to GND as possible. A voltage that is greater than GND may increase the shutdown current.

There are a few methods to control the micro-power shutdown. These include using a single-pole, single-throw switch (SPST), a microprocessor, or a microcontroller. When using a switch, connect the SPST switch between the shutdown pin and V_{DD} . Select normal amplifier operation by closing the switch. Opening the switch applies GND to the SHUTDOWN pin activating micro-power shutdown. The switch and internal pull-down resistor ensures that the SHUTDOWN pin will not float. This prevents unwanted state changes. In a system with a microprocessor or a microcontroller, use a digital output to apply the active-state voltage to the SHUTDOWN pin.

SELECTING EXTERNAL COMPONENTS

Input Capacitor Value Selection

Two quantities determine the value of the input coupling capacitor: the lowest audio frequency that requires amplification and desired output transient suppression.

As shown in [Figure 1](#), the input resistor (R_i) and the input capacitor (C_i) produce a high pass filter cutoff frequency that is found using [Equation 6](#).

$$f_c = 1/2\pi R_i C_i \quad (6)$$

As an example when using a speaker with a low frequency limit of 50Hz, C_i , using Equation (6) is 0.159 μ F. The 0.39 μ F C_{INA} shown in Figure 1 allows the LM4951 to drive high efficiency, full range speaker whose response extends below 30Hz.

Selecting Value For R_C

The LM4951 is designed for very fast turn on time. The Cchg pin allows the input capacitors (CinA and CinB) to charge quickly to improve click/pop performance. Rchg1 and Rchg2 protect the Cchg pins from any over/under voltage conditions caused by excessive input signal or an active input signal when the device is in shutdown. The recommended value for Rchg1 and Rchg2 is 1k Ω . If the input signal is less than $V_{DD}+0.3V$ and greater than $-0.3V$, and if the input signal is disabled when in shutdown mode, Rchg1 and Rchg2 may be shorted out.

OPTIMIZING CLICK AND POP REDUCTION PERFORMANCE

The LM4951 contains circuitry that eliminates turn-on and shutdown transients ("clicks and pops"). For this discussion, turn-on refers to either applying the power supply voltage or when the micro-power shutdown mode is deactivated.

As the $V_{DD}/2$ voltage present at the BYPASS pin ramps to its final value, the LM4951's internal amplifiers are configured as unity gain buffers. An internal current source charges the capacitor connected between the BYPASS pin and GND in a controlled manner. Ideally, the input and outputs track the voltage applied to the BYPASS pin.

The gain of the internal amplifiers remains unity until the voltage on the bypass pin reaches $V_{DD}/2$. As soon as the voltage on the bypass pin is stable, there is a delay to prevent undesirable output transients ("click and pops"). After this delay, the device becomes fully functional.

AUDIO POWER AMPLIFIER DESIGN

Audio Amplifier Design: Driving 1.8W into an 8 Ω BTL

The following are the desired operational parameters:	
Power Output	1.8W _{RMS}
Load Impedance	8 Ω
Input Level	0.3V _{RMS} (max)
Input Impedance	20k Ω
Bandwidth	50Hz–20kHz \pm 0.25dB

The design begins by specifying the minimum supply voltage necessary to obtain the specified output power. One way to find the minimum supply voltage is to use the Equation (7) curve in the Typical Performance Characteristics section. Another way, using Equation 7, is to calculate the peak output voltage necessary to achieve the desired output power for a given load impedance. To account for the amplifier's dropout voltage, two additional voltages, based on the Figure 30 in the Typical Performance Characteristics curves, must be added to the result obtained by Equation (7). The result is Equation (8).

$$V_{\text{opeak}} = \sqrt{(2R_L P_O)} \quad (7)$$

$$V_{DD} = V_{\text{OUTPEAK}} + V_{\text{ODTOP}} + V_{\text{ODBOT}} \quad (8)$$

The commonly used 7.5V supply voltage easily meets this. The additional voltage creates the benefit of headroom, allowing the LM4951 to produce peak output power in excess of 1.8W without clipping or other audible distortion. The choice of supply voltage must also not create a situation that violates of maximum power dissipation as explained above in the POWER DISSIPATION section. After satisfying the LM4951's power dissipation requirements, the minimum differential gain needed to achieve 1.8W dissipation in an 8 Ω BTL load is found using Equation (9).

$$A_V \geq \sqrt{(P_O R_L)} / (V_{IN}) = V_{\text{orms}} / V_{\text{inrms}} \quad (9)$$

Thus, a minimum gain of 12.6 allows the LM4951's to reach full output swing and maintain low noise and THD+N performance. For this example, let $A_{V-BTL} = 13$. The amplifier's overall BTL gain is set using the input (R_i) and feedback (R_f) resistors of the first amplifier in the series BTL configuration. Additionally, A_{V-BTL} is twice the gain set by the first amplifier's R_i and R_f . With the desired input impedance set at 20k Ω , the feedback resistor is found using Equation (10).

$$R_f / R_i = A_{V-BTL} / 2 \quad (10)$$

The value of R_f is 130k Ω (choose 191k Ω , the closest value). The nominal output power is 1.8W.

The last step in this design example is setting the amplifier's -3dB frequency bandwidth. To achieve the desired ± 0.25 dB pass band magnitude variation limit, the low frequency response must extend to at least one-fifth the lower bandwidth limit and the high frequency response must extend to at least five times the upper bandwidth limit. The gain variation for both response limits is 0.17dB, well within the ± 0.25 dB-desired limit. The results are an

$$f_L = 50\text{Hz} / 5 = 10\text{Hz} \quad (11)$$

and an

$$f_H = 20\text{kHz} \times 5 = 100\text{kHz} \quad (12)$$

As mentioned in the [SELECTING EXTERNAL COMPONENTS](#) section, R_i and C_i create a highpass filter that sets the amplifier's lower bandpass frequency limit. Find the coupling capacitor's value using [Equation \(13\)](#).

$$C_i = 1 / 2\pi R_i f_L \quad (13)$$

The result is

$$1 / (2\pi \times 20\text{k}\Omega \times 10\text{Hz}) = 0.795\mu\text{F} \quad (14)$$

Use a 0.82 μF capacitor, the closest standard value.

The product of the desired high frequency cutoff (100kHz in this example) and the differential gain A_{VD} , determines the upper passband response limit. With $A_{VD} = 7$ and $f_H = 100\text{kHz}$, the closed-loop gain bandwidth product (GBWP) is 700kHz. This is less than the LM4951's 3.5MHz GBWP. With this margin, the amplifier can be used in designs that require more differential gain while avoiding performance restricting bandwidth limitations.

RECOMMENDED PRINTED CIRCUIT BOARD LAYOUT

[Figures 6-8](#) show the recommended two-layer PC board layout that is optimized for the DPR0010A. This circuit is designed for use with an external 7.5V supply 8 Ω (min) speakers.

These circuit boards are easy to use. Apply 7.5V and ground to the board's V_{DD} and GND pads, respectively. Connect a speaker between the board's OUT_A and OUT_B outputs.

Demonstration Board Layout

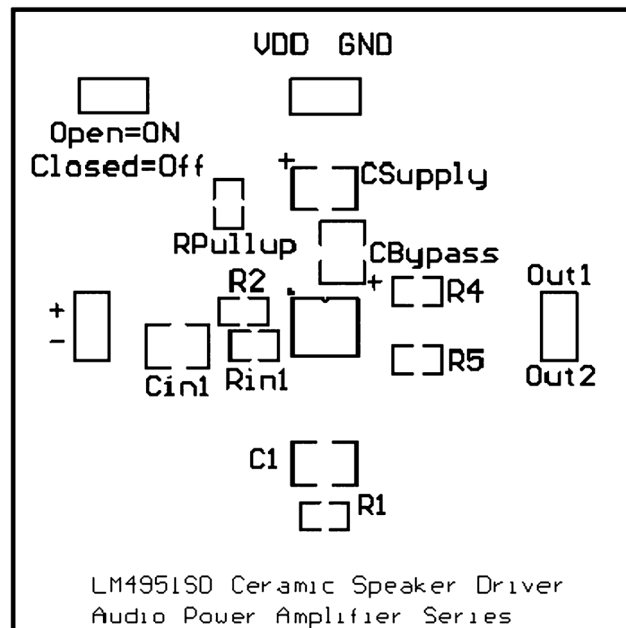

**Figure 35. Recommended TS SE PCB Layout:
Top Silkscreen**

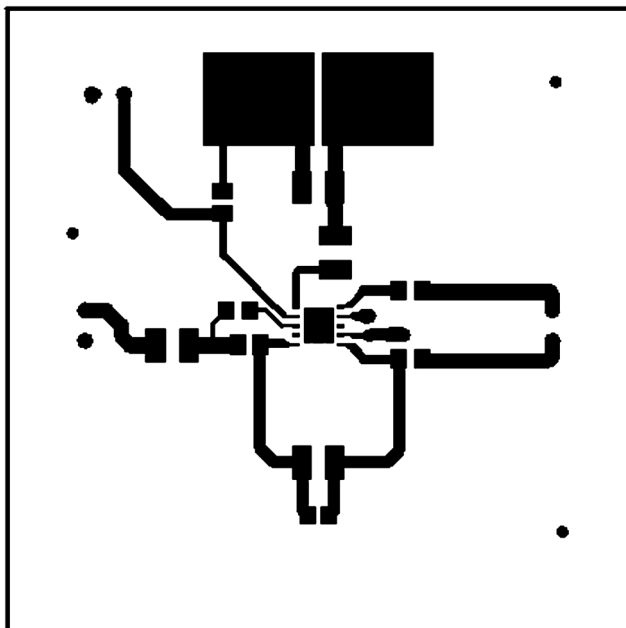

Figure 36. Recommended TS SE PCB Layout: Top Layer

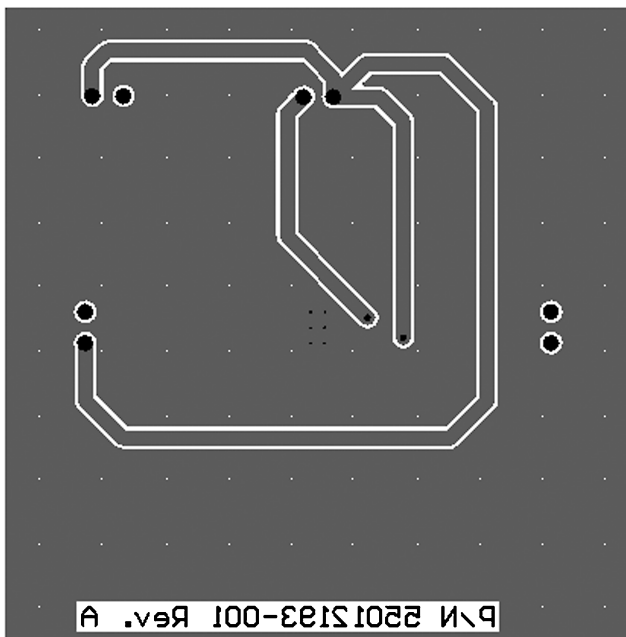

Figure 37. Recommended TS SE PCB Layout: Bottom Layer

Revision History

Rev	Date	Description
1.0	8/25/04	Initial WEB.
1.1	10/19/05	Added the DSBGA pkg, then WEB.

Rev	Date	Description
1.2	08/30/06	Added the Limit value (=35) on the Twu (7.5V Elect Char table), then WEB.
1.3	09/11/06	Added the "Selecting Value For Rc, then WEB.
1.4	05/21/07	Fixed a typo (X3 value = 0.600±0.075) instead of (X3 = 0.600±0.75).
1.5	03/18/09	Text edits.
N	05/03/13	Changed layout of National Data Sheet to TI format.

PACKAGING INFORMATION

Orderable Device	Status (1)	Package Type	Package Drawing	Pins	Package Qty	Eco Plan (2)	Lead finish/ Ball material (6)	MSL Peak Temp (3)	Op Temp (°C)	Device Marking (4/5)	Samples
LM4951SD/NOPB	ACTIVE	WSON	DPR	10	1000	RoHS & Green	SN	Level-1-260C-UNLIM		L4951SD	Samples
LM4951SDX/NOPB	ACTIVE	WSON	DPR	10	4500	RoHS & Green	SN	Level-1-260C-UNLIM		L4951SD	Samples

(1) The marketing status values are defined as follows:

ACTIVE: Product device recommended for new designs.

LIFEBUY: TI has announced that the device will be discontinued, and a lifetime-buy period is in effect.

NRND: Not recommended for new designs. Device is in production to support existing customers, but TI does not recommend using this part in a new design.

PREVIEW: Device has been announced but is not in production. Samples may or may not be available.

OBSOLETE: TI has discontinued the production of the device.

(2) **RoHS:** TI defines "RoHS" to mean semiconductor products that are compliant with the current EU RoHS requirements for all 10 RoHS substances, including the requirement that RoHS substance do not exceed 0.1% by weight in homogeneous materials. Where designed to be soldered at high temperatures, "RoHS" products are suitable for use in specified lead-free processes. TI may reference these types of products as "Pb-Free".

RoHS Exempt: TI defines "RoHS Exempt" to mean products that contain lead but are compliant with EU RoHS pursuant to a specific EU RoHS exemption.

Green: TI defines "Green" to mean the content of Chlorine (Cl) and Bromine (Br) based flame retardants meet JS709B low halogen requirements of <=1000ppm threshold. Antimony trioxide based flame retardants must also meet the <=1000ppm threshold requirement.

(3) MSL, Peak Temp. - The Moisture Sensitivity Level rating according to the JEDEC industry standard classifications, and peak solder temperature.

(4) There may be additional marking, which relates to the logo, the lot trace code information, or the environmental category on the device.

(5) Multiple Device Markings will be inside parentheses. Only one Device Marking contained in parentheses and separated by a "~" will appear on a device. If a line is indented then it is a continuation of the previous line and the two combined represent the entire Device Marking for that device.

(6) Lead finish/Ball material - Orderable Devices may have multiple material finish options. Finish options are separated by a vertical ruled line. Lead finish/Ball material values may wrap to two lines if the finish value exceeds the maximum column width.

Important Information and Disclaimer:The information provided on this page represents TI's knowledge and belief as of the date that it is provided. TI bases its knowledge and belief on information provided by third parties, and makes no representation or warranty as to the accuracy of such information. Efforts are underway to better integrate information from third parties. TI has taken and continues to take reasonable steps to provide representative and accurate information but may not have conducted destructive testing or chemical analysis on incoming materials and chemicals. TI and TI suppliers consider certain information to be proprietary, and thus CAS numbers and other limited information may not be available for release.

In no event shall TI's liability arising out of such information exceed the total purchase price of the TI part(s) at issue in this document sold by TI to Customer on an annual basis.

TAPE AND REEL INFORMATION

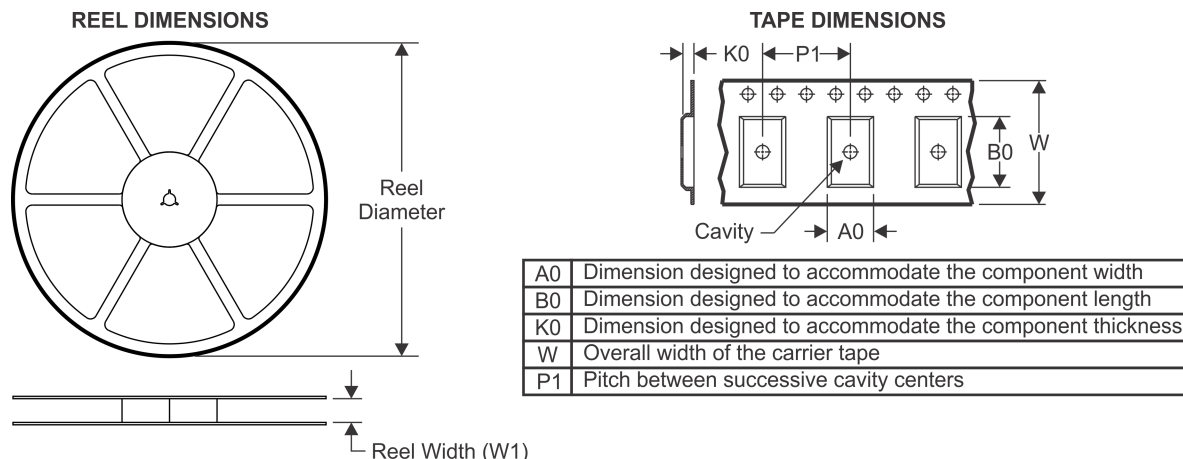

QUADRANT ASSIGNMENTS FOR PIN 1 ORIENTATION IN TAPE



*All dimensions are nominal

Device	Package Type	Package Drawing	Pins	SPQ	Reel Diameter (mm)	Reel Width W1 (mm)	A0 (mm)	B0 (mm)	K0 (mm)	P1 (mm)	W (mm)	Pin1 Quadrant
LM4951SD/NOPB	WSON	DPR	10	1000	178.0	12.4	4.3	4.3	1.3	8.0	12.0	Q1
LM4951SDX/NOPB	WSON	DPR	10	4500	330.0	12.4	4.3	4.3	1.3	8.0	12.0	Q1

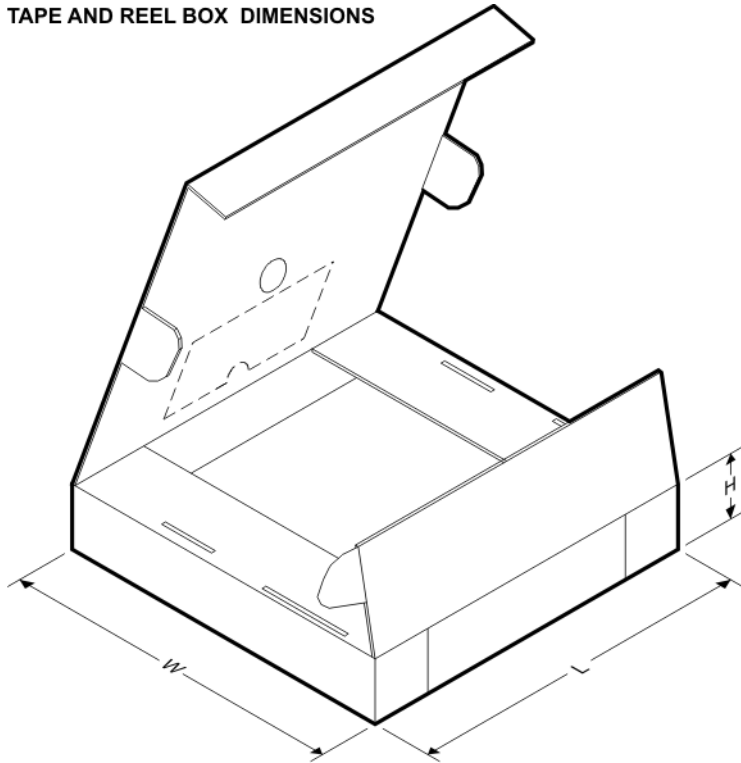
TAPE AND REEL BOX DIMENSIONS

*All dimensions are nominal

Device	Package Type	Package Drawing	Pins	SPQ	Length (mm)	Width (mm)	Height (mm)
LM4951SD/NOPB	WSON	DPR	10	1000	208.0	191.0	35.0
LM4951SDX/NOPB	WSON	DPR	10	4500	367.0	367.0	35.0

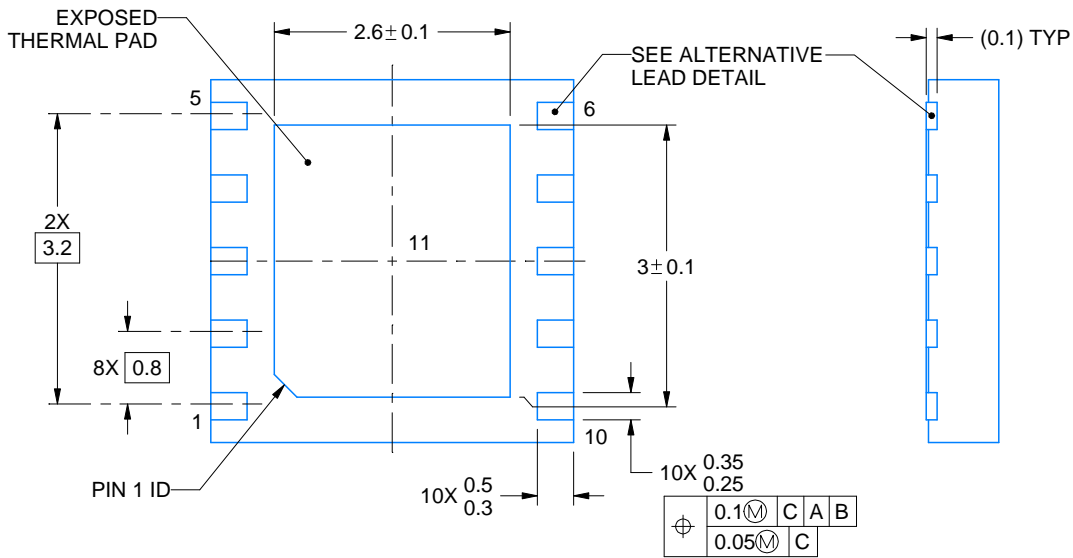
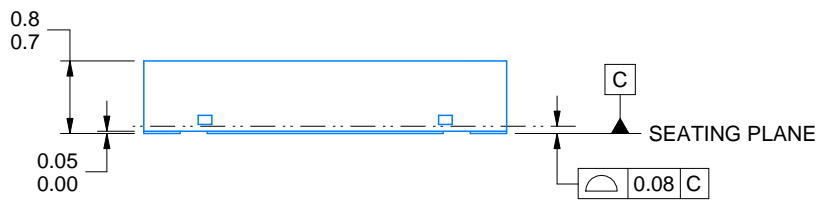
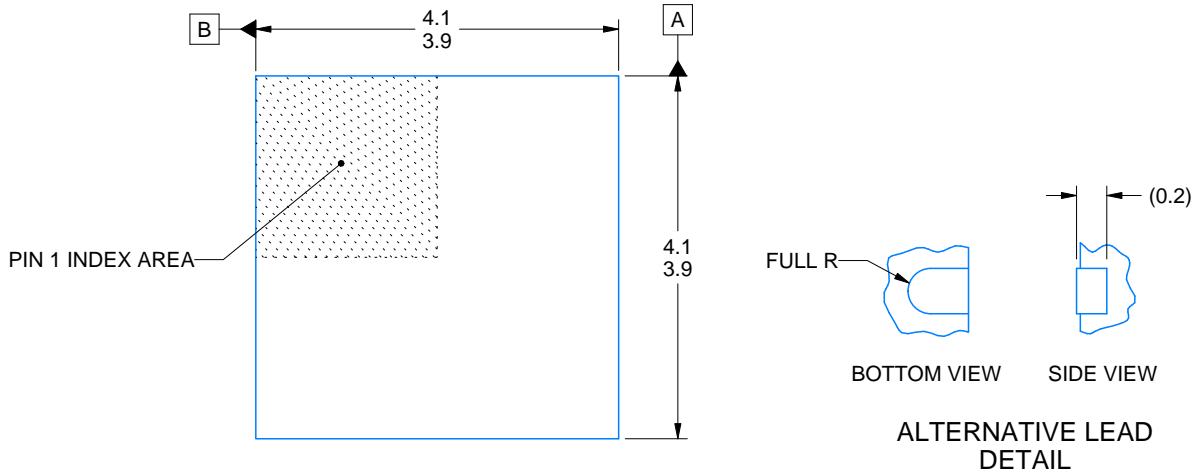
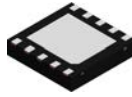

4218856/B 01/2021

NOTES:

1. All linear dimensions are in millimeters. Any dimensions in parenthesis are for reference only. Dimensioning and tolerancing per ASME Y14.5M.
2. This drawing is subject to change without notice.
3. The package thermal pad must be soldered to the printed circuit board for thermal and mechanical performance.

EXAMPLE BOARD LAYOUT

DPR0010A

WSON - 0.8 mm max height

PLASTIC SMALL OUTLINE - NO LEAD

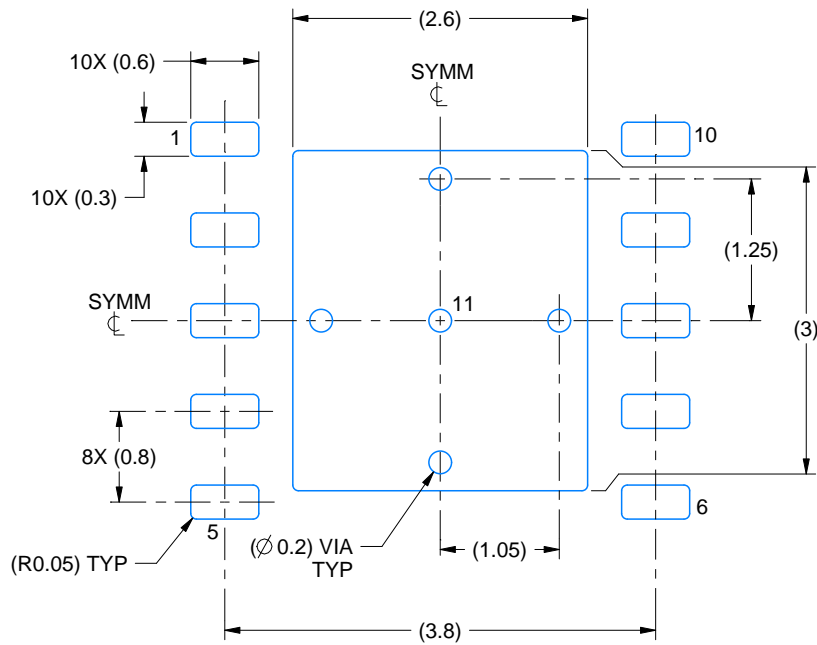

LAND PATTERN EXAMPLE
EXPOSED METAL SHOWN
SCALE:15X

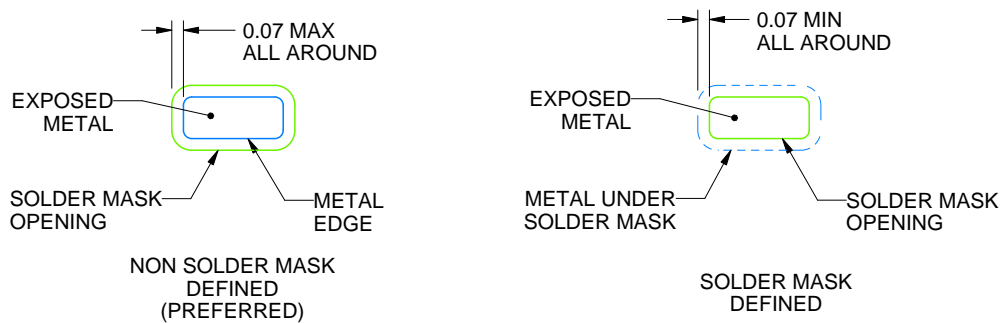

SOLDER MASK DETAILS

4218856/B 01/2021

NOTES: (continued)

4. This package is designed to be soldered to a thermal pad on the board. For more information, see Texas Instruments literature number SLUA271 (www.ti.com/lit/slua271).

EXAMPLE STENCIL DESIGN

DPR0010A

WSN - 0.8 mm max height

PLASTIC SMALL OUTLINE - NO LEAD

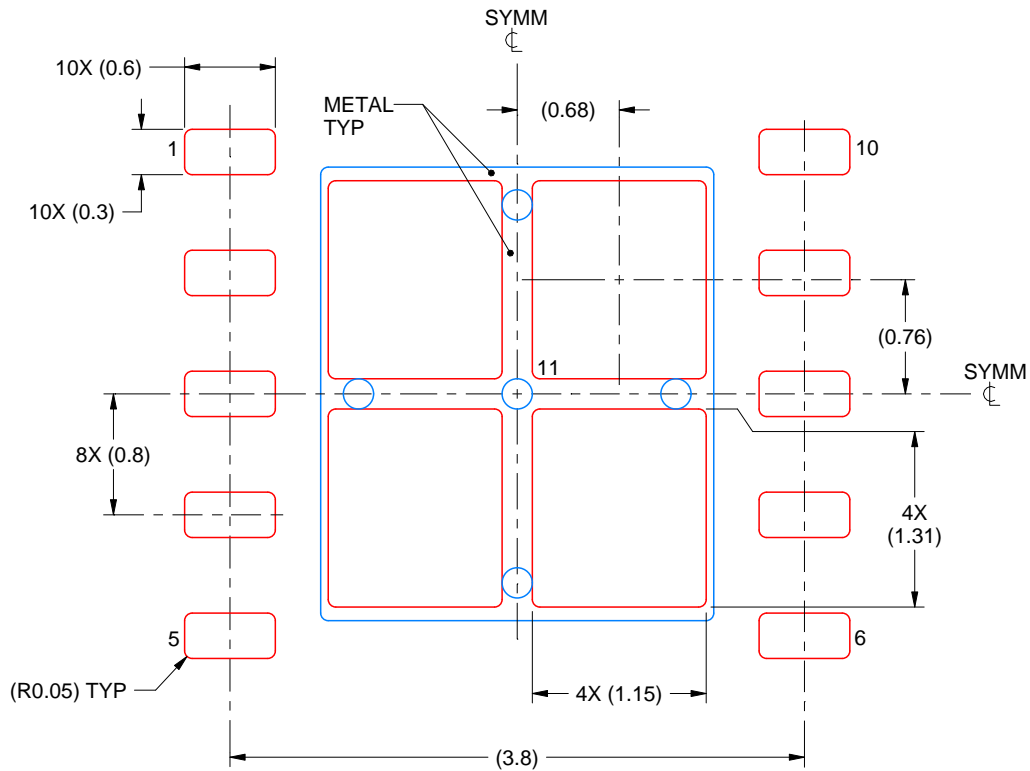

SOLDER PASTE EXAMPLE
BASED ON 0.125 mm THICK STENCIL

EXPOSED PAD 11:
77% PRINTED SOLDER COVERAGE BY AREA
SCALE:20X

4218856/B 01/2021

NOTES: (continued)

5. Laser cutting apertures with trapezoidal walls and rounded corners may offer better paste release. IPC-7525 may have alternate design recommendations.

IMPORTANT NOTICE AND DISCLAIMER

TI PROVIDES TECHNICAL AND RELIABILITY DATA (INCLUDING DATA SHEETS), DESIGN RESOURCES (INCLUDING REFERENCE DESIGNS), APPLICATION OR OTHER DESIGN ADVICE, WEB TOOLS, SAFETY INFORMATION, AND OTHER RESOURCES "AS IS" AND WITH ALL FAULTS, AND DISCLAIMS ALL WARRANTIES, EXPRESS AND IMPLIED, INCLUDING WITHOUT LIMITATION ANY IMPLIED WARRANTIES OF MERCHANTABILITY, FITNESS FOR A PARTICULAR PURPOSE OR NON-INFRINGEMENT OF THIRD PARTY INTELLECTUAL PROPERTY RIGHTS.

These resources are intended for skilled developers designing with TI products. You are solely responsible for (1) selecting the appropriate TI products for your application, (2) designing, validating and testing your application, and (3) ensuring your application meets applicable standards, and any other safety, security, regulatory or other requirements.

These resources are subject to change without notice. TI grants you permission to use these resources only for development of an application that uses the TI products described in the resource. Other reproduction and display of these resources is prohibited. No license is granted to any other TI intellectual property right or to any third party intellectual property right. TI disclaims responsibility for, and you will fully indemnify TI and its representatives against, any claims, damages, costs, losses, and liabilities arising out of your use of these resources.

TI's products are provided subject to [TI's Terms of Sale](#) or other applicable terms available either on ti.com or provided in conjunction with such TI products. TI's provision of these resources does not expand or otherwise alter TI's applicable warranties or warranty disclaimers for TI products.

TI objects to and rejects any additional or different terms you may have proposed.

Mailing Address: Texas Instruments, Post Office Box 655303, Dallas, Texas 75265
Copyright © 2021, Texas Instruments Incorporated