

MATERIAL NO.	ENGINEERING NO.	LENGTH	POLES
1206130003	LWLW3032K05M010	39.4 (1M)	3
1206130004	LWLW4032K05M010	39.4 (1M)	4

NOTICE: THIS PART IS CSA AND FACTORY MUTUAL APPROVED
NO CHANGES CAN BE MADE TO THE ASSEMBLY, COMPONENTS
OR SUPPLIER WITHOUT PRIOR APPROVAL FROM CSA AND
FACTORY MUTUAL.

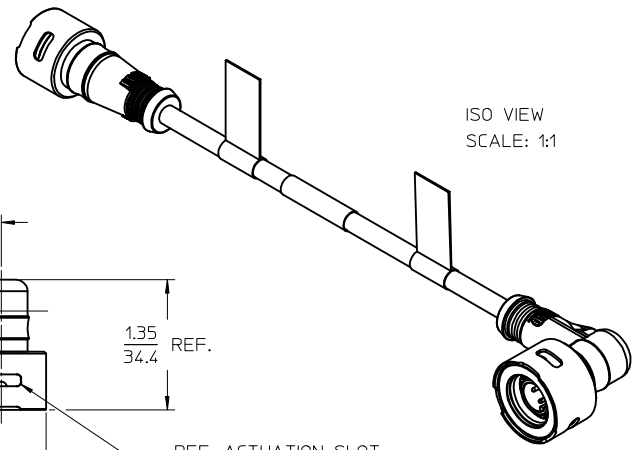

ⓑ LWLWX032K05MXXX

DOUBLE END
POLE QTY.
HEAD STYLE (S)
CABLE TYPE
FINISHED LENGTH
REF. XXX = METERS
EXAMPLE 010= 1M

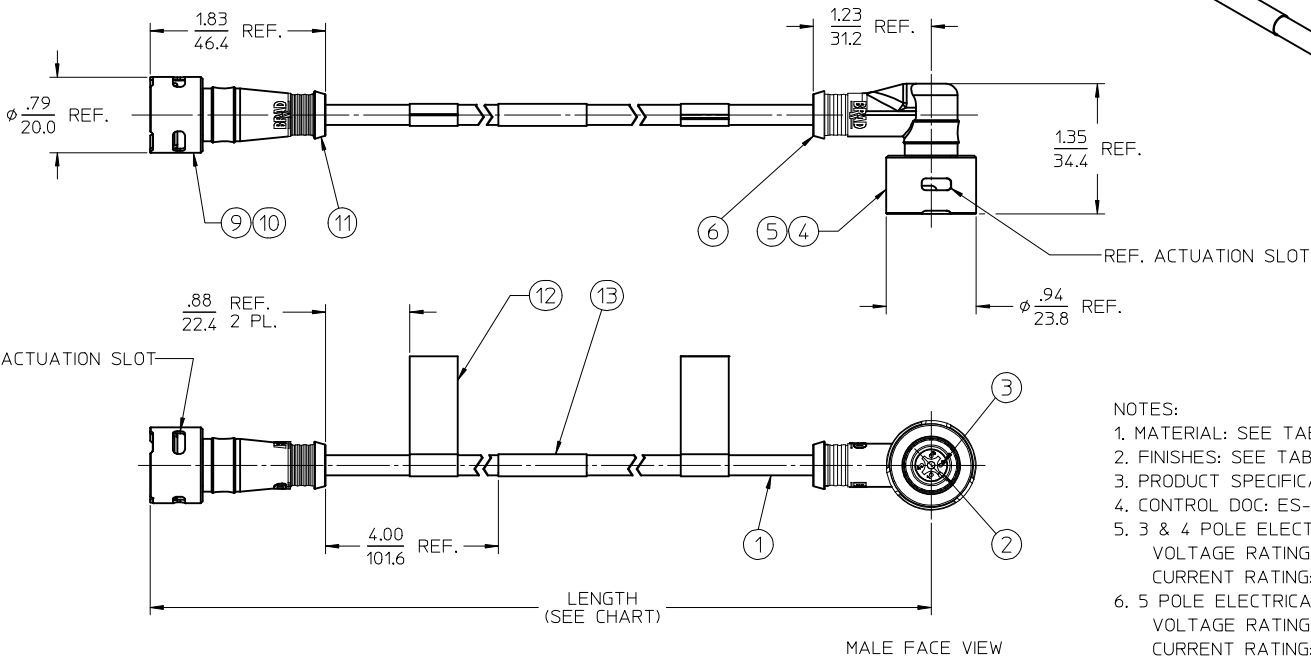

- NOTES:
1. MATERIAL: SEE TABLE
 2. FINISHES: SEE TABLE
 3. PRODUCT SPECIFICATIONS: PS-120614-001
 4. CONTROL DOC: ES-120614-001
 5. 3 & 4 POLE ELECTRICAL SPECIFICATIONS:
VOLTAGE RATING: 125V
CURRENT RATING: 4 AMPS
 6. 5 POLE ELECTRICAL SPECIFICATIONS:
VOLTAGE RATING: 32V
CURRENT RATING: 4 AMPS

FEMALE FACE VIEW			MALE FACE VIEW		
3 POLE	4 POLE	5 POLE	3 POLE	4 POLE	5 POLE
1 BROWN 2 NOT USED 3 BLUE 4 BLACK 5 NOT USED	1 BROWN 2 WHITE 3 BLUE 4 BLACK 5 NOT USED	1 BROWN 2 WHITE 3 BLUE 4 BLACK 5 GRAY	1 BROWN 3 BLUE 4 BLACK	1 BROWN 2 WHITE 3 BLUE 4 BLACK	1 BROWN 2 WHITE 3 BLUE 4 BLACK 5 GRAY

ITEM	QTY.	DESCRIPTION	MATERIAL	FINISH
13	1	WRAP LABEL	PLASTIC FILM	BLACK/YELLOW
12	2	FLAG LABEL (WARNING)	POLYESTER	BLACK/ORANGE
11	1	OVERMOLD, FEMALE	TPE	YELLOW
10	1	OUTER SLEEVE, FEMALE	ST. STEEL	PASSIVATED
9	1	INNER SLEEVE, FEMALE	ST. STEEL	PASSIVATED
8	XX	CONTACT SOCKET	Cu ALLOY	GOLD PLATED
7	1	INSERT, FEMALE	PUR	BLACK
6	1	OVERMOLD, MALE	TPE	YELLOW
5	1	OUTER SLEEVE, MALE	ST. STEEL	PASSIVATED
4	1	INNER SLEEVE, MALE	ST. STEEL	PASSIVATED
3	XX	CONTACT PIN	Cu ALLOY	GOLD PLATED
2	1	INSERT, MALE	PUR	BLACK
1	1	CABLE, #22 AWG ITC/PLTC	TPE	YELLOW

ADDED P/N LEGEND EC NO: IPG2014-0138 DRWR:RSTONE 2013/07/24 CHKD:RSTONE 2013/08/01 APPR:WOODMAN 2013/12/30	QUALITY SYMBOLS 	GENERAL TOLERANCES (UNLESS SPECIFIED)		DIMENSION STYLE IN/MM	SCALE 1:1	DESIGN UNITS INCH	THIRD ANGLE PROJECTION				
		4 PLACES ± --- ± --- 3 PLACES ± --- ± --- 2 PLACES ± --- ± .01 1 PLACE ± 0.3 ± ---	mm INCH ± --- ± --- ± --- ± .01 ± --- ± ---	DRAWN BY: RSTONE DATE: 2011/11/21 CHECKED BY: L. HARTMANN DATE: 2012/01/27 APPROVED BY: JFMURPHY DATE: 2012/04/18	TITLE ULTRA-LOCK ZONE 2 MALE 90 TO FEM STRAIGHT K05, 22 AWG, TPE		MOLEX INCORPORATED		MATERIAL NO. SEE CHART	DOCUMENT NO. SD-120613-002	SHEET NO. 1 OF 1
		DRAFT WHERE APPLICABLE MUST REMAIN WITHIN DIMENSIONS		THIS DRAWING CONTAINS INFORMATION THAT IS PROPRIETARY TO MOLEX INCORPORATED AND SHOULD NOT BE USED WITHOUT WRITTEN PERMISSION							

CLASS 1, DIVISION 2, GROUP A, B, C, OR D
HAZARDOUS LOCATION

NON-HAZARDOUS LOCATION

CLASS 1, DIVISION 2, GROUP A, B, C, OR D
HAZARDOUS LOCATION

NON-HAZARDOUS LOCATION

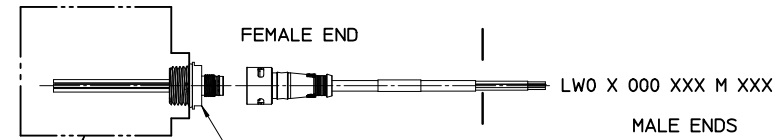

LWR X 006 A18 CXXX
(MALE 1/2" NPT)
LWR X A06 A18 CXXX
(MALE 1/4" NPT)

LW0 X 000 XXX M XXX
MALE ENDS

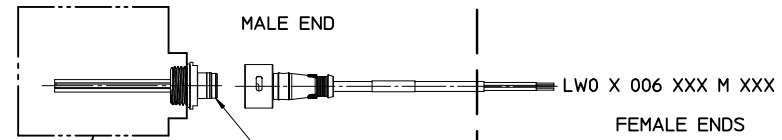
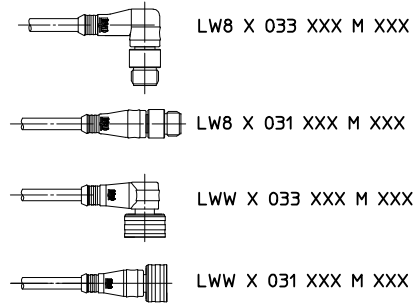
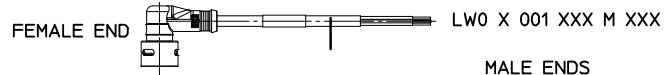
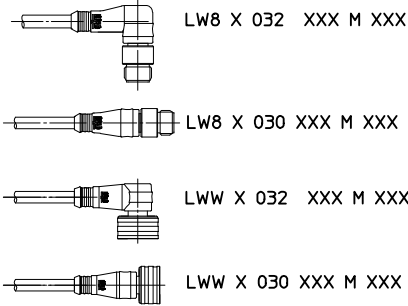

LWR X 000 A18 CXXX
(FEMALE 1/2" NPT)
LWR X A00 A18 CXXX
(FEMALE 1/4" NPT)

LW0 X 006 XXX M XXX
FEMALE ENDS

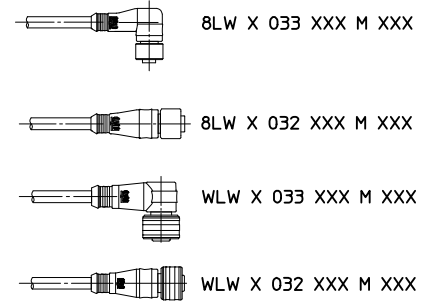
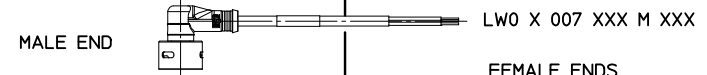
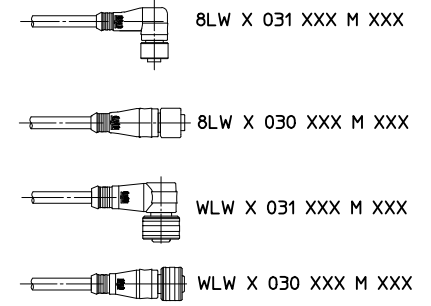

NOTICE: THIS PART IS CSA AND FACTORY MUTUAL APPROVED
NO CHANGES CAN BE MADE TO THE ASSEMBLY, COMPONENTS
OR SUPPLIER WITHOUT PRIOR APPROVAL FROM CSA AND
FACTORY MUTUAL.

NOTES:

1. THE INSTALLATION MUST BE IN ACCORDANCE WITH THE NATIONAL ELECTRICAL CODE (NEC), ANSI/NFPA 70. SPECIFIC REQUIREMENTS FOR THE INSTALLATION OF ITC RATED CABLE MAY BE FOUND IN ARTICLE 501.4(B)(1)(5) AND ARTICLE 727.4
2. THE MOLDED CONSTRUCTION OF THE CORDSET AND GAS/VAPORTIGHT CONTINUOUS SHEATH OF THE CABLE MEET THE REQUIREMENTS OF THE NEC, ARTICLE 501-5(E)(2) FOR CABLE SEALS IN CLASS 1, DIVISION 2

FIELD DEVICE APPROVAL FOR CLASS 1, DIV. 2 OR CLASS 1, ZONE2 INSTALLATIONS

REF. SEE SHEET 3 FOR CONFIGURATION INFORMATION

THIS DRAWING SUPERSEDES ES-120614-001 REV-B

<p>SEE SHEET 3 EC NO: IPG2018-0141 DRAWN BY: DRWINRSTONE 2017/08/28 CHKD: BWOODMAN 2017/08/30 APPR: BWOODMAN 2017/09/06</p>	<p>QUALITY SYMBOLS ▽=0 ▽=0</p>	GENERAL TOLERANCES (UNLESS SPECIFIED)		DIMENSION STYLE IN/MM		SCALE 1:1	DESIGN UNITS INCH	THIRD ANGLE PROJECTION	
				DRAWN BY: RSTONE DATE: 2012/05/18		TITLE CONTROL DOC FOR ULTRA-LOCK ZONE 2			
				CHECKED BY: K JOZWIK DATE: 2012/05/22		MOLEX INCORPORATED DOCUMENT NO. SD-120614-999 SHEET NO. 1 OF 3			
				APPROVED BY: JFMURPHY DATE: 2012/08/27					
		ANGULAR ±---°		MATERIAL NO. 1206149999		THIS DRAWING CONTAINS INFORMATION THAT IS PROPRIETARY TO MOLEX INCORPORATED AND SHOULD NOT BE USED WITHOUT WRITTEN PERMISSION			
		DRAFT WHERE APPLICABLE MUST REMAIN WITHIN DIMENSIONS							

CLASS 1, DIVISION 2, GROUP A, B, C, OR D
HAZARDOUS LOCATION

HAZARDOUS LOCATION

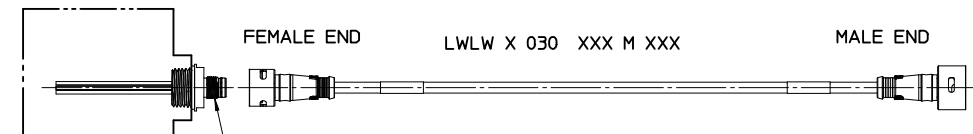

LWR X 006 A18 CXXX
(MALE 1/2" NPT)

LWR X A06 A18 CXXX
(MALE 1/4" NPT)

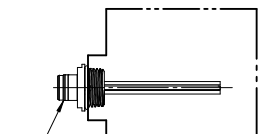

LWR X 000 A18 CXXX
(FEMALE 1/2" NPT)

LWR X A00 A18 CXXX
(FEMALE 1/4" NPT)

LWLW X 032 XXX M XXX

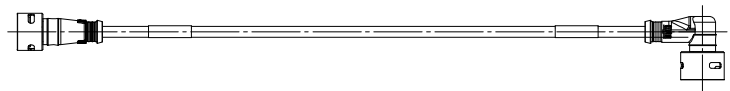

LWLW X 031 XXX M XXX

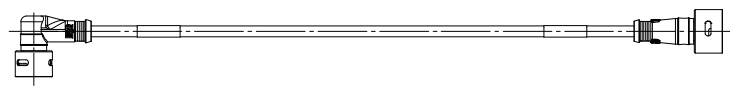

LWLW X 033 XXX M XXX

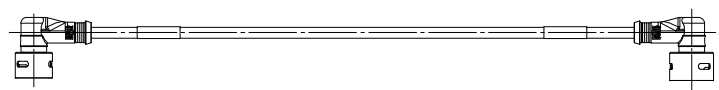

REF:

1. SEE SHEET 1 FOR NOTES
2. SEE SHEET 3 FOR CONFIGURATION INFORMATION

NOTICE: THIS PART IS CSA AND FACTORY MUTUAL APPROVED
NO CHANGES CAN BE MADE TO THE ASSEMBLY, COMPONENTS
OR SUPPLIER WITHOUT PRIOR APPROVAL FROM CSA AND
FACTORY MUTUAL.

SEE SHEET 3 EC NO: JFG2018-0141 2017/08/28 DRAWNR:STONE 2017/08/30 CHKD:WOODMAN 2017/09/06 APPR:WOODMAN	QUALITY SYMBOLS ▽=0 ▽=0	GENERAL TOLERANCES (UNLESS SPECIFIED)		DIMENSION STYLE IN/MM		SCALE 1:1	DESIGN UNITS INCH	THIRD ANGLE PROJECTION	
		4 PLACES ± --- ± --- 3 PLACES ± --- ± --- 2 PLACES ± --- ± --- 1 PLACE ± --- ± ---	mm INCH ± --- ± --- ± --- ± --- ± --- ± --- ± --- ± ---	DRAWN BY RSTONE	DATE 2012/05/18	TITLE CONTROL DOC FOR ULTRA-LOCK ZONE 2		MOLEX INCORPORATED	
DRAFT WHERE APPLICABLE MUST REMAIN WITHIN DIMENSIONS		MATERIAL NO. 1206149999		APPROVED BY JFMURPHY		DATE 2012/08/27			
				SIZE C		THIS DRAWING CONTAINS INFORMATION THAT IS PROPRIETARY TO MOLEX INCORPORATED AND SHOULD NOT BE USED WITHOUT WRITTEN PERMISSION			

M12/MICROCHANGE ULTRA-LOCK CORD CONNECTORS AND CORD SETS

LWO 3 000 C02 M 020 8
 I II III IV V VI VII

I: CONNECTOR TYPE

- LWO= ULTRA-LOCK ZONE 2 MALE OR FEMALE SINGLE END CORDSET
- LWW= ULTRA-LOCK ZONE 2 FEMALE TO STANDARD ULTRA-LOCK MALE DOUBLE ENDED CORDSET
- WLW= ULTRA-LOCK ZONE 2 MALE TO STANDARD ULTRA-LOCK FEMALE DOUBLE ENDED CORDSET
- LW8= ULTRA-LOCK ZONE 2 FEMALE TO STANDARD M12 MALE DOUBLE ENDED CORDSET
- 8LW= ULTRA-LOCK ZONE 2 MALE TO STANDARD M12 FEMALE DOUBLE ENDED CORDSET
- LWLW= ULTRA-LOCK ZONE 2 FEMALE TO ULTRA-LOCK ZONE 2 MALE DOUBLE ENDED CORDSET

II: NUMBER OF POLES: 3= 3 PIN, 4= 4 PIN, 5 = 5 PIN

III: CONFIGURATION

- SINGLE ENDED:
 000= STRAIGHT FEMALE CONNECTOR
 001= FEMALE 90°
 006= STRAIGHT MALE, EXTERNAL THREAD
 007= MALE 90°

DOUBLE ENDED:

- 030= STRAIGHT FEMALE CONNECTOR TO STRAIGHT MALE CONNECTOR
- 031= FEMALE 90° TO MALE STRAIGHT
- 032= FEMALE STRAIGHT TO MALE 90°
- 033= FEMALE 90° TO MALE 90°

IV: CABLE TYPE

- C02= SJ00W YELLOW, 18 AWG, DC CODE (CSA ONLY) **G**
- K03= PLTC/ITC, 18 AWG, TPE JACKET
- K05= PLTC/ITC, 22 AWG, TPE JACKET

V: UNIT OF MEASURE

- F= FEET
- M= METERS

VI: CABLE LENGTH (MAY BE ANY 3 DIGIT NUMBER FROM 001-100)

- 1ST DIGIT= 10 X LENGTH
- 2ND DIGIT= 1 X LENGTH
- 3RD DIGIT= .1 X LENGTH

VII: COUPLING NUT MATERIAL

ULTRA-LOCK ZONE 2 END(S) ARE STAINLESS STEEL

M12 OR ULTRA-LOCK:

- NONE = STANDARD MATERIAL (NICKEL PLATED BRASS)
- 8= STAINLESS STEEL

NOTICE: THIS PART IS CSA AND FACTORY MUTUAL APPROVED
 NO CHANGES CAN BE MADE TO THE ASSEMBLY, COMPONENTS
 OR SUPPLIER WITHOUT PRIOR APPROVAL FROM CSA AND
 FACTORY MUTUAL.

M12/MICROCHANGE ULTRA-LOCK OUTLETS

LWR 3 A00 A18 M 020 8
 I II III IV V VI VII

I: CONNECTOR TYPE

LWR= LOCKING INLETS AND OUTLETS

II: NUMBER OF POLES 3=3 PIN, 4= 4 PIN, & 5= 5 PIN

III: CONFIGURATION

- SINGLE ENDED:
 A00= FEMALE STRAIGHT (INT.THEAD) 1/4-18 NPT
 A06= MALE STRAIGHT (EXT.THEAD) 1/4-18 NPT
 000= FEMALE STRAIGHT (INT.THEAD) 1/2-14 NPT
 006= MALE STRAIGHT (EXT.THEAD) 1/2-14 NPT

G IV: WIRE TYPE

- A18= 22 AWG, PVC, DC COLOR CODE, UL TYPE 1061
- A16= 18 AWG, PVC, DC COLOR CODE, UL TYPE 1569

V: UNIT OF MEASURE

- A= INCHES
- F= FEET
- C= CENTIMETERS
- M= METERS

VI: WIRE LENGTH (MAY BE ANY 3 DIGIT NUMBER FROM 001-100)

- 1ST DIGIT= 10 X LENGTH
- 2ND DIGIT= 1 X LENGTH
- 3RD DIGIT= .1 X LENGTH

VII: SHELL MATERIAL

- M12 OR ULTRA-LOCK:
- NONE = STANDARD MATERIAL (COPPER ZINC ALLOY)
- 3= NICKEL PLATED BRASS
- 8= STAINLESS STEEL

CORSET NOTE IV, ADD CSA OUTLET NOTE IV, REMOVE PCB PINS EC NO: IPGZ018-0141 DR: DRWHRSTONE 2017/08/28 CHKD: BWOODMAN 2017/08/30 APPR: BWOODMAN 2017/09/06	QUALITY SYMBOLS ▽=0 ▽=0	GENERAL TOLERANCES (UNLESS SPECIFIED) mm INCH 4 PLACES ±--- ±--- 3 PLACES ±--- ±--- 2 PLACES ±--- ±--- 1 PLACE ±--- ±--- ANGULAR ±---°	DIMENSION STYLE IN/MM DRAWN BY DATE RSTONE 2012/05/18 CHECKED BY DATE K JOZWIK 2012/05/22 APPROVED BY DATE JFMURPHY 2012/08/27	SCALE 1:1	DESIGN UNITS INCH	THIRD ANGLE PROJECTION ☉	CONTROL DOC FOR ULTRA-LOCK ZONE 2
	MOLEX INCORPORATED						
	DRAFT WHERE APPLICABLE MUST REMAIN WITHIN DIMENSIONS			MATERIAL NO. 1206149999	DOCUMENT NO. SD-120614-999	SHEET NO. 3 OF 3	
	THIS DRAWING CONTAINS INFORMATION THAT IS PROPRIETARY TO MOLEX INCORPORATED AND SHOULD NOT BE USED WITHOUT WRITTEN PERMISSION						

CLASS 1, DIVISION 2, GROUP A, B, C, OR D
HAZARDOUS LOCATION

NON-HAZARDOUS LOCATION

CLASS 1, DIVISION 2, GROUP A, B, C, OR D
HAZARDOUS LOCATION

NON-HAZARDOUS LOCATION

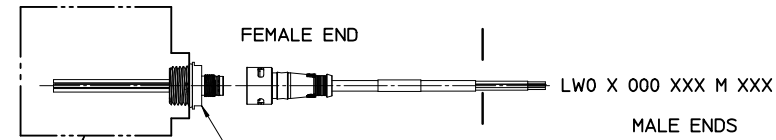

LWR X 006 A18 CXXX
(MALE 1/2" NPT)
LWR X A06 A18 CXXX
(MALE 1/4" NPT)

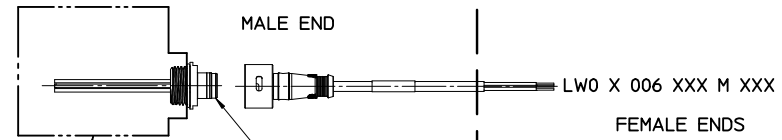
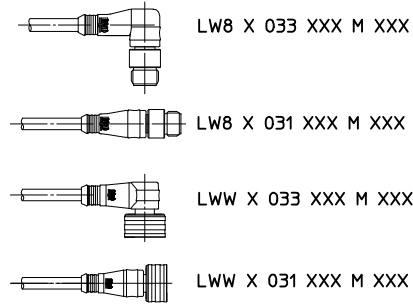
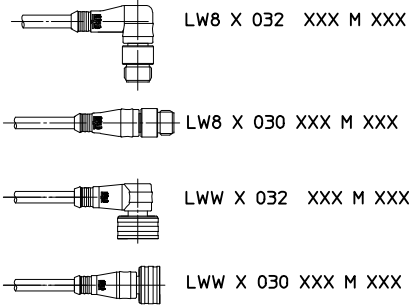

LWR X 000 A18 CXXX
(FEMALE 1/2" NPT)
LWR X A00 A18 CXXX
(FEMALE 1/4" NPT)

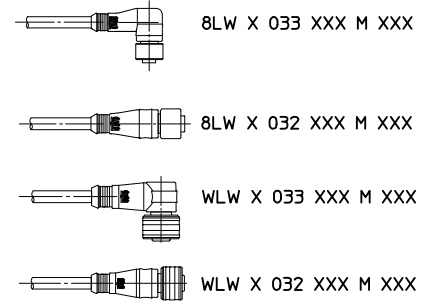
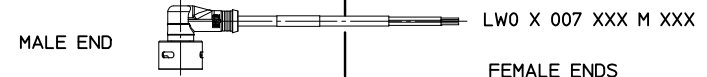
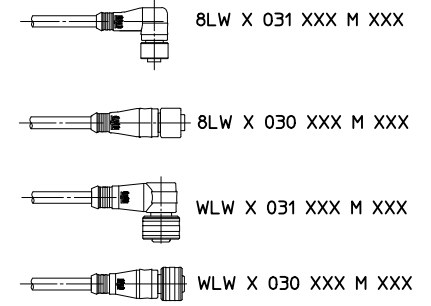

NOTES:

1. THE INSTALLATION MUST BE IN ACCORDANCE WITH THE NATIONAL ELECTRICAL CODE (NEC), ANSI/NFPA 70. SPECIFIC REQUIREMENTS FOR THE INSTALLATION OF ITC RATED CABLE MAY BE FOUND IN ARTICLE 501.4(B)(1)(5) AND ARTICLE 727.4
2. THE MOLDED CONSTRUCTION OF THE CORDSET AND GAS/VAPORTIGHT CONTINUOUS SHEATH OF THE CABLE MEET THE REQUIREMENTS OF THE NEC, ARTICLE 501-5(E)(2) FOR CABLE SEALS IN CLASS 1, DIVISION 2

FIELD DEVICE APPROVAL FOR CLASS 1, DIV. 2 OR CLASS 1, ZONE2 INSTALLATIONS

REF. SEE SHEET 3 FOR CONFIGURATION INFORMATION

NOTICE: THIS PART IS CSA AND FACTORY MUTUAL APPROVED
NO CHANGES CAN BE MADE TO THE ASSEMBLY, COMPONENTS
OR SUPPLIER WITHOUT PRIOR APPROVAL FROM CSA AND
FACTORY MUTUAL.

THIS DRAWING SUPERSEDES ES-120614-001 REV-B

SEE SHEET 3 EC NO: IPG2018-0141 DRAWN BY: DRWINRSTONE 2017/08/28 CHKD: BWOODMAN 2017/08/30 APPR: BWOODMAN 2017/09/06 REV:	QUALITY SYMBOLS = 0 = 0	GENERAL TOLERANCES (UNLESS SPECIFIED)		DIMENSION STYLE		SCALE	DESIGN UNITS	THIRD ANGLE PROJECTION			
				IN/MM		1:1	INCH				
		4 PLACES ± --- ± ---	3 PLACES ± --- ± ---	2 PLACES ± --- ± ---	1 PLACE ± --- ± ---	DRAWN BY: RSTONE	DATE: 2012/05/18	TITLE: CONTROL DOC FOR ULTRA-LOCK ZONE 2			
		ANGULAR ± --- °				CHECKED BY: K JOZWIK	DATE: 2012/05/22	APPROVED BY: JFMURPHY			
DRAFT WHERE APPLICABLE MUST REMAIN WITHIN DIMENSIONS		MATERIAL NO. 1206149999		DOCUMENT NO. SD-120614-999		SHEET NO. 1 OF 3		THIS DRAWING CONTAINS INFORMATION THAT IS PROPRIETARY TO MOLEX INCORPORATED AND SHOULD NOT BE USED WITHOUT WRITTEN PERMISSION			

CLASS 1, DIVISION 2, GROUP A, B, C, OR D
HAZARDOUS LOCATION

HAZARDOUS LOCATION

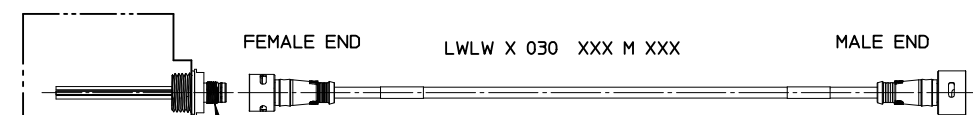

LWR X 006 A18 CXXX
(MALE 1/2" NPT)

LWR X A06 A18 CXXX
(MALE 1/4" NPT)

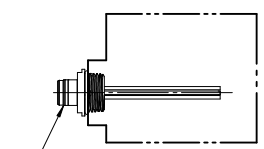

LWR X 000 A18 CXXX
(FEMALE 1/2" NPT)

LWR X A00 A18 CXXX
(FEMALE 1/4" NPT)

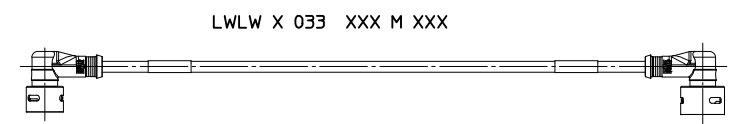
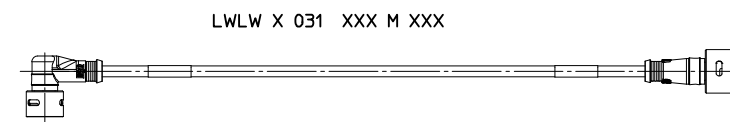
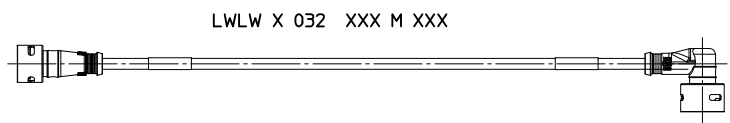

- REF:
1. SEE SHEET 1 FOR NOTES
 2. SEE SHEET 3 FOR CONFIGURATION INFORMATION

NOTICE: THIS PART IS CSA AND FACTORY MUTUAL APPROVED
NO CHANGES CAN BE MADE TO THE ASSEMBLY, COMPONENTS
OR SUPPLIER WITHOUT PRIOR APPROVAL FROM CSA AND
FACTORY MUTUAL.

SEE SHEET 3 EC NO: JFG2018-0141 2017/08/28 DRAWNR:STONE 2017/08/30 CHKD:WOODMAN 2017/09/06 APPR:WOODMAN	QUALITY SYMBOLS ▽=0 ▽=0	GENERAL TOLERANCES (UNLESS SPECIFIED)		DIMENSION STYLE IN/MM		SCALE 1:1	DESIGN UNITS INCH	THIRD ANGLE PROJECTION	
		4 PLACES ± --- ± --- 3 PLACES ± --- ± --- 2 PLACES ± --- ± --- 1 PLACE ± --- ± --- ANGULAR ± ---°	mm INCH DRAWN BY RSTONE DATE 2012/05/18 CHECKED BY K JOZWIK DATE 2012/05/22 APPROVED BY JFMURPHY DATE 2012/08/27	TITLE CONTROL DOC FOR ULTRA-LOCK ZONE 2					
MATERIAL NO. 1206149999	DRAFT WHERE APPLICABLE MUST REMAIN WITHIN DIMENSIONS		DOCUMENT NO. SD-120614-999		SHEET NO. 2 OF 3				
THIS DRAWING CONTAINS INFORMATION THAT IS PROPRIETARY TO MOLEX INCORPORATED AND SHOULD NOT BE USED WITHOUT WRITTEN PERMISSION									

M12/MICROCHANGE ULTRA-LOCK CORD CONNECTORS AND CORD SETS

LWO 3 000 C02 M 020 8
 I II III IV V VI VII

I: CONNECTOR TYPE

- LWO= ULTRA-LOCK ZONE 2 MALE OR FEMALE SINGLE END CORDSET
- LWW= ULTRA-LOCK ZONE 2 FEMALE TO STANDARD ULTRA-LOCK MALE DOUBLE ENDED CORDSET
- WLW= ULTRA-LOCK ZONE 2 MALE TO STANDARD ULTRA-LOCK FEMALE DOUBLE ENDED CORDSET
- LW8= ULTRA-LOCK ZONE 2 FEMALE TO STANDARD M12 MALE DOUBLE ENDED CORDSET
- 8LW= ULTRA-LOCK ZONE 2 MALE TO STANDARD M12 FEMALE DOUBLE ENDED CORDSET
- LWLW= ULTRA-LOCK ZONE 2 FEMALE TO ULTRA-LOCK ZONE 2 MALE DOUBLE ENDED CORDSET

II: NUMBER OF POLES: 3= 3 PIN, 4= 4 PIN, 5 = 5 PIN

III: CONFIGURATION

- SINGLE ENDED:
- 000= STRAIGHT FEMALE CONNECTOR
 - 001= FEMALE 90°
 - 006= STRAIGHT MALE, EXTERNAL THREAD
 - 007= MALE 90°

DOUBLE ENDED:

- 030= STRAIGHT FEMALE CONNECTOR TO STRAIGHT MALE CONNECTOR
- 031= FEMALE 90° TO MALE STRAIGHT
- 032= FEMALE STRAIGHT TO MALE 90°
- 033= FEMALE 90° TO MALE 90°

IV: CABLE TYPE

- C02= SJ00W YELLOW, 18 AWG, DC CODE (CSA ONLY) **G**
- K03= PLTC/ITC, 18 AWG, TPE JACKET
- K05= PLTC/ITC, 22 AWG, TPE JACKET

V: UNIT OF MEASURE

- F= FEET
- M= METERS

VI: CABLE LENGTH (MAY BE ANY 3 DIGIT NUMBER FROM 001-100)

- 1ST DIGIT= 10 X LENGTH
- 2ND DIGIT= 1 X LENGTH
- 3RD DIGIT= .1 X LENGTH

VII: COUPLING NUT MATERIAL

ULTRA-LOCK ZONE 2 END(S) ARE STAINLESS STEEL

M12 OR ULTRA-LOCK:

- NONE = STANDARD MATERIAL (NICKEL PLATED BRASS)
- 8= STAINLESS STEEL

NOTICE: THIS PART IS CSA AND FACTORY MUTUAL APPROVED
 NO CHANGES CAN BE MADE TO THE ASSEMBLY, COMPONENTS
 OR SUPPLIER WITHOUT PRIOR APPROVAL FROM CSA AND
 FACTORY MUTUAL.

M12/MICROCHANGE ULTRA-LOCK OUTLETS

LWR 3 A00 A18 M 020 8
 I II III IV V VI VII

I: CONNECTOR TYPE

LWR= LOCKING INLETS AND OUTLETS

II: NUMBER OF POLES 3=3 PIN, 4= 4 PIN, & 5= 5 PIN

III: CONFIGURATION

- SINGLE ENDED:
- A00= FEMALE STRAIGHT (INT.THEAD) 1/4-18 NPT
 - A06= MALE STRAIGHT (EXT.THEAD) 1/4-18 NPT
 - 000= FEMALE STRAIGHT (INT.THEAD) 1/2-14 NPT
 - 006= MALE STRAIGHT (EXT.THEAD) 1/2-14 NPT

G IV: WIRE TYPE

- A18= 22 AWG, PVC, DC COLOR CODE, UL TYPE 1061
- A16= 18 AWG, PVC, DC COLOR CODE, UL TYPE 1569

V: UNIT OF MEASURE

- A= INCHES
- F= FEET
- C= CENTIMETERS
- M= METERS

VI: WIRE LENGTH (MAY BE ANY 3 DIGIT NUMBER FROM 001-100)

- 1ST DIGIT= 10 X LENGTH
- 2ND DIGIT= 1 X LENGTH
- 3RD DIGIT= .1 X LENGTH

VII: SHELL MATERIAL

- M12 OR ULTRA-LOCK:
- NONE = STANDARD MATERIAL (COPPER ZINC ALLOY)
- 3= NICKEL PLATED BRASS
- 8= STAINLESS STEEL

CORSET NOTE IV, ADD CSA OUTLET NOTE IV, REMOVE PCB PINS EC NO: IPGZ018-0141 DR: MHRSTONE 2017/08/28 CHKD: BWOODMAN 2017/08/30 APPR: BWOODMAN 2017/09/06	QUALITY SYMBOLS ▽=0 ▽7=0	GENERAL TOLERANCES (UNLESS SPECIFIED) mm INCH 4 PLACES ±--- ±--- 3 PLACES ±--- ±--- 2 PLACES ±--- ±--- 1 PLACE ±--- ±--- ANGULAR ±---°	DIMENSION STYLE IN/MM DRAWN BY DATE RSTONE 2012/05/18 CHECKED BY DATE K JOZWIK 2012/05/22 APPROVED BY DATE JFMURPHY 2012/08/27	SCALE 1:1	DESIGN UNITS INCH	THIRD ANGLE PROJECTION ☉	CONTROL DOC FOR ULTRA-LOCK ZONE 2
	MOLEX INCORPORATED						
	DRAFT WHERE APPLICABLE MUST REMAIN WITHIN DIMENSIONS			MATERIAL NO. 1206149999	DOCUMENT NO. SD-120614-999	SHEET NO. 3 OF 3	
	THIS DRAWING CONTAINS INFORMATION THAT IS PROPRIETARY TO MOLEX INCORPORATED AND SHOULD NOT BE USED WITHOUT WRITTEN PERMISSION						